



**MARS EXPRESS – MARSIS
TO
PLANETARY SCIENCE ARCHIVE
INTERFACE CONTROL DOCUMENT**

INFOCOM TECHNICAL REPORT NO. 024.005.2003

ISSUE 3.1

NOVEMBER 26, 2007

Prepared by: **Roberto Orosei
Richard L. Huff
Anton B. Ivanov
Raffaella Noschese**

Approved by: **Giovanni Picardi
Jeffrey J. Plaut**



Distribution List

Recipient	Organisation



Change Log

Date	Sections Changed	Reasons for Change
24-09-2007	Section 3.4.3.2	Completed description of the INDEX directory
26-11-2007	All sections	Modifications following review by PSA



Table of Contents

1	INTRODUCTION	6
1.1	PURPOSE AND SCOPE	6
1.2	ARCHIVING AUTHORITIES	6
1.3	CONTENTS	6
1.4	INTENDED READERSHIP	6
1.5	APPLICABLE DOCUMENTS	6
1.6	RELATIONSHIPS TO OTHER INTERFACES	7
1.7	ACRONYMS AND ABBREVIATIONS	7
2	OVERVIEW OF INSTRUMENT DESIGN, DATA HANDLING PROCESS AND PRODUCT GENERATION	9
2.1	SCIENTIFIC OBJECTIVES	9
2.2	INSTRUMENT DESCRIPTION	10
2.2.1	<i>Antennas</i>	10
2.2.2	<i>Frequencies</i>	10
2.2.3	<i>Transmitted Waveforms</i>	10
2.3	ON-BOARD PROCESSING	11
2.3.1	<i>Analogue-to-Digital Conversion</i>	11
2.3.2	<i>I/Q Synthesis</i>	11
2.3.3	<i>Doppler Processing</i>	11
2.3.4	<i>Range Processing</i>	11
2.3.5	<i>Multi-look</i>	12
2.3.6	<i>Data Compression</i>	12
2.3.7	<i>Individual Echoes Collection</i>	12
2.3.8	<i>Data Storage in Flash Memory</i>	12
2.3.9	<i>Acquisition Phase</i>	13
2.3.10	<i>Active Ionosphere Sounding</i>	14
2.3.11	<i>Passive Ionosphere Sounding</i>	14
2.3.12	<i>Operative Modes</i>	14
2.4	INSTRUMENT OPERATION	15
2.4.1	<i>Operation Sequence Table</i>	15
2.4.2	<i>Parameter Table</i>	16
2.5	DATA DESCRIPTION	17
2.5.1	<i>Frames</i>	17
2.5.2	<i>Time Series and Spectra</i>	18
2.5.3	<i>Sample Types</i>	18
2.6	DATA STRUCTURE	19
2.6.1	<i>Frame Structure</i>	19
2.6.2	<i>Ancillary Data Structure by Instrument Mode</i>	20
2.6.3	<i>Scientific Data Structure by Instrument Mode</i>	20
2.6.4	<i>Individual Echoes</i>	21
2.6.5	<i>Flash Memory</i>	21
2.7	DATA HANDLING PROCESS	24
2.8	PRODUCT GENERATION	25
2.9	OVERVIEW OF DATA PRODUCTS	25
2.9.1	<i>Pre-Flight Data Products</i>	25
2.9.2	<i>Sub-System Tests</i>	25
2.9.3	<i>Instrument Calibrations</i>	26
2.9.4	<i>In-Flight Data Products</i>	26
2.9.5	<i>Ancillary Data Usage</i>	26
3	ARCHIVE FORMAT AND CONTENT	26
3.1	FORMAT AND CONVENTIONS	27
3.1.1	<i>Deliveries and Archive Volume Format</i>	27



3.1.2	<i>Data Directory Naming Convention</i>	27
3.1.3	<i>File Naming Convention</i>	27
3.1.4	<i>Special observation : Phobos</i>	28
3.2	STANDARDS USED IN DATA PRODUCT GENERATION	28
3.2.1	<i>PDS Standards</i>	28
3.2.2	<i>Time Standards</i>	29
3.2.3	<i>Reference Systems</i>	30
3.3	DATA VALIDATION.....	30
3.4	CONTENT	30
3.4.1	<i>Volume Set</i>	30
3.4.2	<i>Data Set</i>	30
3.4.3	<i>Directories</i>	32
4	DETAILED INTERFACE SPECIFICATIONS	35
4.1	STRUCTURE AND ORGANISATION OVERVIEW	35
4.2	EXPERIMENT DATA RECORD DATA SET: DEFINITION AND CONTENT	36
4.3	EXPERIMENT DATA RECORD DATA PRODUCT DESIGN	37
4.3.1	<i>AIS_EDR, CAL_EDR, RXO_EDR and SSx_yyy_CMP_EDR Data Product Design</i>	37
4.3.2	<i>SSx_yyy_IND_EDR Data Product Design</i>	38
4.3.3	<i>SSx_yyy_UNC_EDR data products</i>	39
4.3.4	<i>SSx_yyy_RAW_EDR Data Product Design</i>	39
4.4	REDUCED DATA RECORD SUBSURFACE DATA SET: DEFINITION AND CONTENT	40
4.5	REDUCED DATA RECORD SUBSURFACE DATA PRODUCT DESIGN	41
4.5.1	<i>SSx_RDR Data Product Design</i>	41
	APPENDIXES.....	42
A	EXAMPLE PDS LABEL FOR MARSIS DATA PRODUCT FILES.....	42
B	AUXILIARY DATA STRUCTURES	44
C	SCIENTIFIC DATA STRUCTURE.....	55
D	KEYWORD LISTING FOR GEO FILES	56
E	KEYWORD LISTING FOR PDS LABELS	58



1 INTRODUCTION

1.1 PURPOSE AND SCOPE

The purpose of this EAICD (Experimenter to Archive Interface Control Document) is two folds. First it provides users of the MARSIS instrument with detailed description of the product and a description of how it was generated, including data sources and destinations. Secondly, it is the official interface between the MARSIS team and the Planetary Science Archive (PSA) of ESA.

This document is also intended to provide user specification to the developers of the MARSIS data processing software.

The specifications in this document apply to all MARSIS Data Products that are produced during the Mars Express mission through the MARSIS Principal Investigator institution, namely the INFOCOM Department of the University of Rome "La Sapienza".

1.2 ARCHIVING AUTHORITIES

The Planetary Data System Standard is used as archiving standard by NASA for U.S. planetary missions, and is implemented by PDS and ESA for European planetary missions.

ESA implements an online science archive, the PSA, to support and ease data ingestion and to offer additional services to the scientific user community and science operations teams such as

- search queries that allow searches across instruments, missions and scientific disciplines;
- several data delivery options as direct download of data products, linked files and data sets or ftp download of data products, linked files and data sets.

1.3 CONTENTS

This document describes the data flow of the MARSIS instrument on Mars Express from the S/C until the insertion into the PSA for ESA. It includes information on how data were processed, formatted, labelled and uniquely identified. The document discusses general naming schemes for data volumes, data sets, data and label files. Standards used to generate the product are explained. Software that may be used to access the product is described. The design of the data set structure and of the data product is provided. Examples of these and further explanatory material are given in the appendixes.

1.4 INTENDED READERSHIP

The staff of archiving authority (Planetary Data System for NASA and Planetary Science Archive for ESA) design team and any potential user of the MARSIS data. Typically, these individuals would be software engineers, data analysts, or planetary scientists.

1.5 APPLICABLE DOCUMENTS

- [AD01] MARSIS Flight User Manual, Issue 3, INFOCOM ID-MAR-0008-INF, 18 December 2003
- [AD02] MARSIS DES Operation Sequence Table, Issue 1, LABEN TL 19392, 29 January 2003
- [AD03] MARSIS DES Parameters Table, Issue 3, LABEN TL 18546
- [AD04] MARSIS Packet Structure Definition, Issue 6, LABEN TL 16927, 3 February 2003
- [AD05] Mars Exploration Rover Project Planetary Constants and Models, Version 2, JPL IOM 312.F-02-003, 4 October



2002

- [AD06] Mars Express Archive Generation, Validation and Transfer Plan, Revision 1.0, ESA-MEX-TN-4009, 21 June 2001
- [AD07] Mars Express Auxiliary Data Conversion into SPICE Kernels and Distribution, Issue 1.0, MEX-EST-PL-10210, 20 September 2002
- [AD08] Mars Express Master Science Plan, Draft 1.0, MEX-EST-PL-11912, 12 May 2003
- [AD09] Planetary Data System Data Preparation Workbook, Version 3.1, JPL D-7669, Part 1, 17 February 1995
- [AD10] Planetary Data System Standards Reference, Version 3.6, JPL D-7669, Part 2, 3 August 2003
- [AD11] Planetary Science Data Dictionary, Revision D, JPL D-7116, 15 July 1996
- [AD12] Planetary Science Archive - Experiment Data Release Concept, Issue 1.14, SOP-RSSD-TN-015, 22 October 2004
- [AD13] Planetary Science Archive - Required Keywords, Issue 1.4, SOP-RSSD-LI-004, 27 January 2004
- [AD14] Planetary Science Data Archive Technical Note - Geometry and Position Information, Issue 3, Revision 4, SOP-RSSD-TN-010, 9 November 2004

1.6 RELATIONSHIPS TO OTHER INTERFACES

Other interfaces that have an impact on MARSIS data set generation, packaging, distribution, and documentation include:

- MARSIS calibration data/software: reprocessing of calibration data or a change to the software may have a direct impact on the generation of the data sets.
- Release Concept: Changes would directly impact data set generation, packaging, distribution, and documentation.
- PSA Archive Delivery Requirements: Any delivery requirement changes will directly impact the MARSIS datasets.
- SPICE Data: Changes to these data will affect any geometry information contained in data products and geometry index files.
- Geolib and SPICE Software Libraries: As above.
- PVV Software: Changes to this validation software could result in changes to labels or data sets.

1.7 ACRONYMS AND ABBREVIATIONS

ACQ	Acquisition phase
AIS	Active Ionosphere Sounding mode
ASDC	ASI Science Data Centre
ASI	Agenzia Spaziale Italiana (Italian Space Agency)
CAL	Calibration mode
CD-ROM	Compact Disk - Read Only Memory
CMP	Compressed data
DCG	Digital Chirp Generator
DVD	Digital Versatile Disk
EAICD	Experimenter to Planetary Science Archive Interface Control Document
ESA	European Space Agency
ESOC	European Space Operation Centre
ESTEC	European Space Technology Centre
FFT	Fast Fourier Transform
IND	Individual Echoes
LOL	Loss of Lock
MARSIS	Mars Advanced Radar for Subsurface and Ionosphere Sounding
MEX	Mars Express
PSA	Planetary Science Archive
NPM	Noise Power Measurement
OST	Operation Sequence Table
PIS	Passive Ionosphere Sounding mode
PT	Parameter Table
PVV	PSA Volume Verifier
RAW	Raw data



**MARS EXPRESS - MARSIS
TO PLANETARY SCIENCE ARCHIVE
INTERFACE CONTROL DOCUMENT**

Document No. INFOCOM TR 024.005.2003
Issue/Rev. No. 3.0
Date November 26, 2007

RXO	Receive Only mode
S/C	Spacecraft
SCET	Spacecraft Elapsed Time
SS1-SS5	Subsurface Sounding modes 1-5
TC	Telecommand
TM	Telemetry
TRK	Tracking phase
UNC	Uncompressed data



2 OVERVIEW OF INSTRUMENT DESIGN, DATA HANDLING PROCESS AND PRODUCT GENERATION

2.1 SCIENTIFIC OBJECTIVES

The primary objective of MARSIS is to map the distribution of water, both liquid and solid, in the upper portions of the crust of Mars. Detection of such reservoirs of water will address key issues in the hydrologic, geologic, climatic and possible biologic evolution of Mars, including:

- the current and past global inventory of water,
- mechanisms of transport and storage of water,
- the role of liquid water and ice in shaping the landscape of Mars,
- the stability of liquid water and ice at the surface as an indication of climatic conditions,
- the implications of the hydrologic history for the evolution of possible Martian ecosystems.

Three secondary objectives are defined for the MARSIS experiment: subsurface geologic probing, surface characterisation, and ionosphere sounding.

1. The first objective consists in probing the subsurface of Mars, to characterise and map geologic units and structures in the third dimension. Detection of subsurface geologic boundaries will allow:
 - determination of the thickness and properties of sedimentary units, such as outflow channel deposits and possible lacustrine materials,
 - mapping of the thickness of polar layered deposits, and measurements of their physical properties that are likely to record climate variations,
 - an inventory of mobile materials such as dust and sand deposits,
 - study of volcanic stratigraphy to understand eruptive processes and crust evolution,
 - mapping of subsurface geologic structures (e.g., folds and faults) to understand tectonics of the Martian crust and address such issues as the nature of the global dichotomy and the history of the Tharsis plateau.
2. An additional secondary objective consists in acquiring information about the surface of Mars. The specific goals of this part of the experiment are to characterise the roughness of the surface at scales of tens of meters to kilometres, to measure the radar reflection coefficient of the surface and to generate a topographic map of the surface at approximately 15-30 kilometres lateral resolution. These data sets can be used to address a wide range of scientific questions, including:
 - the large-scale surface roughness of various geologic units, and implications for the processes of emplacement and modification,
 - determination of the bulk density (providing constraints on the composition) of upper crust materials,
 - a global topographic data set to complement those derived by other techniques.
3. A final secondary objective is to use MARSIS as an ionosphere sounder to characterize the interactions of the solar wind with the ionosphere and upper atmosphere of Mars. Radar studies of the ionosphere will allow:
 - global measurements of the ionosphere electron density,
 - investigation of the influence of the Sun and the solar wind on the electron density.

Although the instrument is expected to detect dielectric discontinuities in the Mars subsurface, it may not always provide precise indications of their nature. Unambiguous detection of liquid water and ice reservoirs will require mapping the presence of discontinuities over the surface of the planet, and studying their correlation with depth, latitude, surface topography and local geologic units. Sounding data at multiple frequencies will be used to characterise the dielectric discontinuities, and to help distinguish possible water-related interfaces from lithologic ones.



2.2 INSTRUMENT DESCRIPTION

MARSIS is a multi-frequency nadir-looking pulse-limited radar sounder and altimeter, which uses synthetic aperture techniques and a secondary receiving antenna to enhance subsurface reflections. MARSIS can be effectively operated at any altitude lower than 800 km in subsurface sounding mode, and below 1200 km in ionosphere sounding mode. The instrument consists of two antenna assemblies and an electronics assembly. Maximum penetration depths are achieved at the lowest frequencies, and penetration will be in the order of a few kilometres, depending on the nature of the material being sounded. On the dayside of Mars, the solar wind-induced ionosphere does not allow subsurface sounding at frequencies below approximately 3.5 MHz, as the signal would be reflected back at the radar without reaching the surface. To achieve greater subsurface probing depths, operations on the night side of Mars are thus strongly preferred.

For subsurface sounding, a “chirp” signal will be generated and transmitted at each operating frequency for a period of about 250 microseconds. The instrument then switches to a receive mode and records the echoes from the surface and subsurface. The total transmit-receive cycle lasts a few milliseconds, depending on altitude. The received signals are passed to an analogue-to-digital converter and compressed in range and azimuth. The azimuth integration accumulates a few seconds of data and results in an along-track footprint size of 10 km. The cross-track footprint size is on the order of 20 km. Digital on-board processing greatly reduces the output data rate to 75 kilobits per second or less. For each along-track footprint, echo profiles will show the received power as a function of time delay, with a depth resolution of 50-100 m, depending on the wave propagation speed in the crust.

Active ionosphere sounding consists of transmitting a pulse from MARSIS at a frequency f , and then measuring the intensity of the reflected radar echo as a function of time delay. For a radar signal incident on a horizontally stratified ionosphere, a strong specular reflection occurs from the level where the wave frequency is equal to the electron plasma frequency. By measuring the time delay for the reflected signal (controlled by the group delay), the plasma frequency, and therefore the electron density can be derived as a function of height. The frequency of the transmitted pulse is systematically stepped to yield time delay as a function of frequency.

2.2.1 ANTENNAS

MARSIS antenna assembly consists of two antennas, a dipole and a monopole. The primary dipole antenna, parallel to the surface and to the direction of spacecraft motion, is used for transmission of pulses and for reception of pulse echoes reflected by the Martian surface, subsurface and ionosphere. The secondary monopole antenna, oriented along the nadir, has a null in the nadir direction, and it is thus sensitive to off-nadir surface returns. Such surface returns could mask subsurface echoes arriving at the same time, and are thus an undesired contribution to the received echoes (“clutter”): the monopole antenna is used in subsurface sounding to remove clutter from the signal received by the dipole.

2.2.2 FREQUENCIES

MARSIS is an ultra-wideband radar sounder capable of transmitting at frequencies ranging from approximately 10 kHz up to 5.5 MHz. For subsurface sounding, the transmitted signal has a 1 MHz bandwidth, centred at either 1.8 MHz, 3 MHz, 4 MHz or 5 MHz. For ionosphere sounding, transmission frequencies will range from about 10 KHz to 5.5. MHz, with a transmitted bandwidth of 10.937 kHz and an identical frequency granularity.

2.2.3 TRANSMITTED WAVEFORMS

For subsurface sounding, the transmitted waveform is a chirp, a long pulse that is linearly modulated in frequency. Chirps are used when the length of the pulse for the desired range resolution is so short that to achieve good signal-to-noise ratio the pulse would require a peak power exceeding the limits imposed by the mission design. The chirp allows a resolution that depends on the bandwidth of the pulse rather than on its duration, but requires processing of the received signal: with a bandwidth B , the approximate time resolution of the output pulse, after processing, is $1/B$.

MARSIS is capable of transmitting two chirps having different frequencies in close succession, thus allowing effective simultaneous subsurface sounding at two different bands.



Also in subsurface sounding mode, MARSIS can transmit a train of four short unmodulated pulses: with this transmission scheme, time resolution is determined by the duration of the signal, while the signal-to-noise ratio is increased, compared to the echo from a single pulse, by summing the four pulse echoes.

For ionosphere sounding, the transmitted waveform is simply a short pulse at a constant frequency, resulting in an almost monochromatic tone.

2.3 ON-BOARD PROCESSING

Due to limits in permitted data rate for data transmission between the instrument and the solid state mass memory of the spacecraft, and constraints on the data volume that can be down-linked to Earth, most data processing will be performed within the instrument itself. Major tasks performed by MARSIS digital processing unit are Doppler processing, range processing, surface echo acquisition and tracking, and multi-looking. Different operative modes will require all, some or none of these capabilities: this section aims at providing a general description of the working of on-board processing from a subsurface sounding perspective, but differences with other operative modes will be noted as well.

2.3.1 ANALOGUE-TO-DIGITAL CONVERSION

Any signal received from the antennas is converted to digital numbers by means of an analogue-to-digital converter, sampling the waveform at a frequency of 2.8 MHz. To adequately represent the characteristics of a signal containing frequencies higher than the sampling frequency, as for example in the case of subsurface echoes at bands centred at 3 MHz, 4 MHz or 5 MHz, the signal is lowered to a carrier frequency of 0.7 MHz through a mixer before sampling takes place.

2.3.2 I/Q SYNTHESIS

Digital numbers produced by the signal sampling process are represented as 1-byte signed integers, which, aside from a scaling factor, are actual voltages from the real signal. For a more convenient numerical treatment of the signal during digital processing, such samples are converted to single-precision complex numbers (four bytes for both the real and imaginary part) by means of a numerical interpolation scheme called I/Q synthesis, which exploits the fact that real functions have symmetric Fourier transforms to represent signal properties by means of a complex function with only half of the samples of the original real function.

2.3.3 DOPPLER PROCESSING

Conceptually, Doppler processing of pulse echoes consists in artificially adding a delay, corresponding to a phase shift of the complex signal, to the samples of each pulse, and then in summing the samples so as to allow the constructive sum of the signal component whose delay (phase shift) from one pulse to the next corresponds to a desired direction (usually nadir or close to nadir). This is called also synthetic aperture processing, and is used to improve both horizontal resolution in the along-track direction and signal-to-noise ratio: horizontal resolution becomes that of an equivalent antenna whose length is equal to the segment of the spacecraft trajectory over which pulse echoes are summed coherently, whereas signal-to-noise ratio improves by a factor equal to the number of coherently summed pulses.

In MARSIS subsurface sounding, the same group of echoes undergoing synthetic aperture processing can be used to focus multiple points on the surface, by changing the phase shift from echo to echo so as to produce constructive interference in different directions. The resulting processed echoes are also called Doppler filters.

2.3.4 RANGE PROCESSING

Range processing consists in computing the correlation between the transmitted pulse and received echoes. If the transmitted amplitude is constant during the pulse, the correlation with an echo identical to the transmitted signal takes the form of a $(\sin x)/x$ pulse, whose amplitude is $B\tau$ times the amplitude of the input signal (τ is the chirp duration). This



process, called also range compression, is performed on ground for most subsurface sounding modes, on the digitally sampled data, to properly compensate ionospheric effects: accurate coherent pulse compression requires in fact detailed knowledge of the modulation of the returning signals, whose phase structure is distorted in their (two-way) propagation through the ionosphere.

2.3.5 MULTI-LOOK

Multi-look processing is the non-coherent sum of echoes (that is, phase information in the complex signal is ignored), after both Doppler and range processing, performed to increase the signal-to-noise ratio and reduce speckle, this last being the effect of random fluctuations in the return signal observed from an area-extensive target represented by one pixel. Because this process requires that multiple observations of the same area are available for the summing, it spans across several frames in which the same spot on the surface is observed at slightly different angles of incidence in different adjacent synthetic apertures.

2.3.6 DATA COMPRESSION

After the completion of on-board processing, to conveniently reduce data volume, digitalized radar echoes can be converted from four-byte real numbers to one-byte integer numbers by extracting and storing the exponent of the sample with the largest absolute value, and by normalizing the entire echo by that exponent. Because the mantissa of a four-byte real number is 23 bits long instead of the 8 bits available in a single-byte representation, data compression causes a loss of precision: this, however, is deemed to be negligible, as the available dynamic range for signal representation is estimated to be above the signal-to-noise ratio.

At the end of the processing described in the previous subsection, compression is performed by first calculating the highest exponent in the numerical vector of real numbers containing the echo. Such exponent is reported with 8-bit precision in the auxiliary data accompanying the frame to which the echo belongs. Then, the vector is normalized to the maximum exponent by shifting to the right the bits of the mantissa of each real sample by a number of positions equal to the difference between the sample exponent and the maximum exponent: this causes the loss of the rightmost bits of the sample mantissa, as only the first 8 bits remaining after the shift are stored for download. It is to be noted that the so-called hidden bit in the IEEE 4-byte representation of a real number is accounted for in the right shifting of the mantissa bits.

2.3.7 INDIVIDUAL ECHOES COLLECTION

MARSIS can be programmed to skip all on-board processing and down-link raw data as they come out of the analogue-to-digital converter. This option allows the storage of a number of individual echoes in a memory buffer, for subsequent transmission as science telemetry packets.

Because the data production rate of individual echoes is much higher than the data rate possible on the spacecraft data bus, raw data are acquired only for very limited time intervals, and are then transferred over a much longer time span from MARSIS to the spacecraft mass memory.

It is important to remember that individual echoes collection is possible only during subsurface sounding, and that such echoes always come in addition to the processed data, which are transmitted to the ground in any case. Thus, individual echoes are the unprocessed version of data which are also received, after processing, as part of the scientific telemetry of the instrument.

2.3.8 DATA STORAGE IN FLASH MEMORY

Another option available in MARSIS for the retrieval of raw data is the use of flash memory chips within the instrument itself. Collection of echoes from the analogue-to-digital converter is similar to that of individual echoes, but data are stored in a different physical device, a long-term memory that can be read and cleared for subsequent overwriting only by means of a specific telecommand, which causes a dump of its entire content to the spacecraft on-board mass memory.



Also, flash memory can be used to store processed data before the final step of data compression is performed: this option is used mainly to check if truncation of data precision is affecting the results.

It is important to remember that storage of data in the flash memory is possible only during subsurface sounding, and that such data always come in addition to the processed data, which are transmitted to the ground in any case. Thus, the flash memory will contain unprocessed data which are also received, after processing, as part of the scientific telemetry of the instrument.

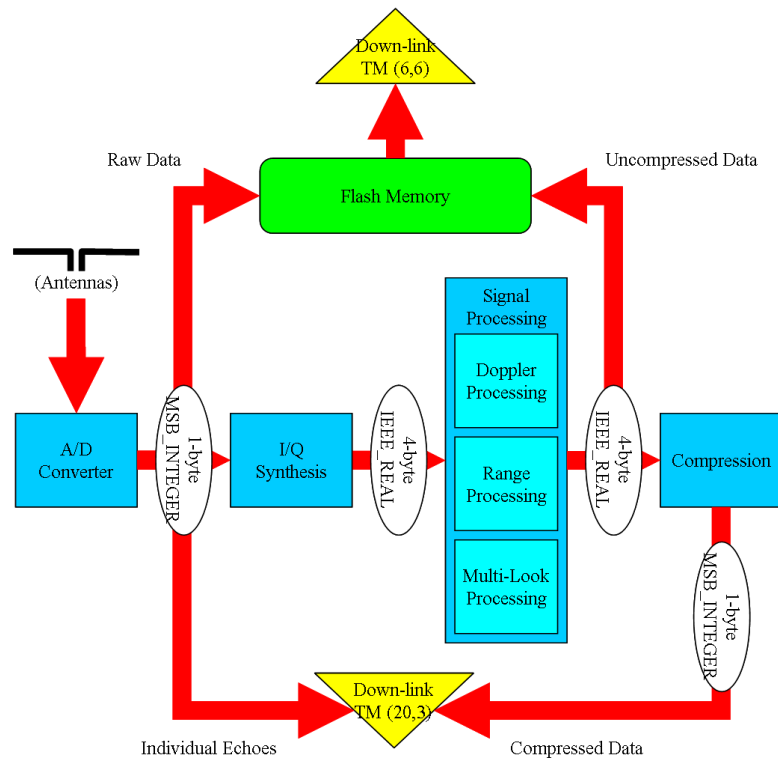

Figure 2.3.8 – 1 Conceptual diagram of MARSIS on-board processing during subsurface sounding. TM (20,3) is the normal scientific telemetry produced by the instrument during operation, while TM (6,6) is the telemetry produced by the instrument following a request to dump the flash memory.

2.3.9 ACQUISITION PHASE

Subsurface sounding is critically dependent on an accurate knowledge of the time delay between transmission and reception to correctly perform the collection and sampling of echoes. Such delay is significantly affected by properties of the Martian ionosphere such as maximum plasma frequency and total electron content, about which very little information is available. MARSIS is thus capable of performing a preliminary determination of the two-way travel time of the transmitted pulse by means of a special way of operating called acquisition phase. Unless programmed to skip acquisition, whenever the instrument enters a new subsurface sounding sub-mode or uses a different frequency band, it starts transmitting a much longer pulse having a much smaller bandwidth (200 kHz), and collecting echoes over a much longer receiving window.

During acquisition, on-board processing of the echoes is aimed at determining the time at which the received power is the greatest, under the assumption that such strong reflection is caused by the surface. Once successfully determined, this time is used to place the receiving window for subsequent sounding in the nominal way of operating, called tracking. During tracking, a check of the received power is continuously performed to determine if changes of the ionosphere have put the echo outside the receiving window: in such instance, the instrument reverts to acquisition until a new time delay between transmission and reception can be determined.



2.3.10 ACTIVE IONOSPHERE SOUNDING

Each active ionosphere sounding observation consists in transmitting and receiving echoes from 160 short, narrow-banded pulses at different frequencies. When a pulse reaches the layer in the ionosphere where the plasma frequency is equal to its frequency, it is reflected back at the radar. Because the detailed variation of the plasma frequency in the ionosphere is unknown, the time delay of each echo cannot be predicted, and it is thus necessary to have an extremely long receiving window to ensure that useful data are collected. To reduce data volume, the receiving window is divided into 80 segments, each of which is as long as the transmitted pulse: power received within each segment is computed, and the result is stored for down-link. Even after this processing, the resulting data rate is still too high for the spacecraft data bus, and it is thus necessary to transfer ionosphere data from MARSIS to the spacecraft mass memory over a time span six times longer than the one used for their acquisition.

2.3.11 PASSIVE IONOSPHERE SOUNDING

Passive ionosphere sounding is performed during every subsurface sounding observation, by opening the receiver and collecting the signal produced by the ionosphere plasma around the spacecraft. A weak, thermally excited emission line can often be detected in ionosphere plasmas at the electron plasma frequency: the spectrum of the recorded signal will thus allow the determination of the local electron density, as derived from the plasma frequency.

Passive Ionosphere Sounding consists in acquiring signal samples, converting them to complex numbers through I/Q synthesis, performing an FFT on them and extracting the square modulus of the resulting spectrum.

2.3.12 OPERATIVE MODES

In addition to subsurface and ionosphere sounding, MARSIS is capable of two more data collection modes that are not science-related, but are rather used for the testing of the instrument. Hardware calibration mode and receive-only mode are identical in their sequencing of data acquisition, differing only for the fact that in receive-only mode no pulses are actually transmitted. In both modes, 80 echoes are collected from both antennas at one of the frequency bands used in subsurface sounding, stored in a buffer as they come out of the analogue-to-digital converter, and, because the resulting data rate would be too high for the spacecraft data bus, transferred to the spacecraft mass memory over a time span eighty times longer than the one used for data acquisition.

Because of the many possible options in programming the instrument, subsurface sounding has been specialized into five different sub-modes, each of which is characterized by a defined set of pulse transmission, echo reception and on-board processing choices. Their different characteristics, as well as those of all remaining operative modes, are summarized in the table below.

Operative Mode	Acronym	Transmitted Waveform	Receiving Antennas	On-board Processing
Hardware Calibration	CAL	Chirp (One Band)	Dipole Monopole	None
Receive Only	RXO	None (One Band)	Dipole Monopole	None
Active Ionosphere Sounding	AIS	Monochromatic Pulse	Dipole	Echo Power Evaluation
Subsurface Sounding 1	SS1	Chirp (Two Bands)	Dipole Monopole	I/Q Synthesis Doppler Processing (One Doppler Filter) Data Compression
Subsurface Sounding 2	SS2	Chirp (Two Bands)	Dipole	I/Q Synthesis Doppler Processing (One Doppler Filter) Range Processing Multi-look Processing Data Compression



Subsurface Sounding 3	SS3	Chirp (Two Bands)	Dipole Monopole	I/Q Synthesis Doppler Processing (Three Doppler Filters) Data Compression
Subsurface Sounding 4	SS4	Chirp (One Band)	Dipole	I/Q Synthesis Doppler Processing (Five Doppler Filters) Data Compression
Subsurface Sounding 5	SS5	Unmodulated Pulse Train (Two Bands)	Dipole Monopole	I/Q Synthesis Doppler Processing (Three Doppler Filters) Data Compression
Passive Ionosphere Sounding	PIS	None (Two Bands)	Dipole or Monopole	I/Q Synthesis Echo Power Evaluation

Table 2.3.12 – 1 Characteristics of pulse transmission, echo reception and on-board processing for MARSIS operative modes.

2.4 INSTRUMENT OPERATION

MARSIS has been designed to perform subsurface sounding at each orbit when the altitude is below 800 Km. A highly eccentric orbit such as the Mars Express orbit places the spacecraft within 800 Km from the surface for a period of about 26 minutes. This would allow mapping of about 100 degrees of arc on the surface of Mars each orbit, allowing extensive coverage at all latitudes within the nominal mission duration. To achieve this global coverage MARSIS has been designed to support both day side and night side operations, although performances are maximized during night time (solar zenith angle $>90^\circ$), when the ionosphere plasma frequency drops off significantly and the lower frequency bands, which have greater subsurface penetration capability, can be used.

Active Ionosphere Sounding will be also carried out by MARSIS at certain passes when the spacecraft is below 1200 Km of altitude, both during day and night time.

The instrument is commanded by means of two tables, the Operations Sequence Table (OST) and the Parameters Table (PT), which are up-linked from ground as part of the instrument programming and commanding, and loaded in the instrument memory at switch-on. They are described below.

2.4.1 OPERATION SEQUENCE TABLE

The OST contains commands, which specify selection of operative modes and their duration for the current orbit. Contents of the OST are prepared on the ground, based on the Science Team decisions on which antenna configuration (dipole only or dipole and monopole), frequency and mode duration to use in a particular part of the orbit. In addition, the OST contains necessary parameters to perform Passive Ionosphere Sounding, parameters for SS2 mode, transmission power, ground acquisition presets and flash memory management. The maximum number of rows in an OST is 512. It is possible to execute two tables during the same orbit, but this requires rebooting the instrument to force the upload of another OST.

The following table contains a brief description of fields in the OST. For more information on these fields, refer to [AD02].

OST field	Number of bits	Bit Position	Description
Pad	8	1-8	Not significant
Mode duration	24	9-32	Duration of the mode expressed in PRI
Pad	2	33-34	Not significant



Mode Selection	4	35-38	Engineering modes : CHECK/INIT(0), STANDBY (1), WARM-UP1(2), WARMUP2(3), IDLE(4) Calibration modes: CALIBR (5), REC. ONLY(6). Science modes: ACT. IONO (7), SS1(8), SS2 (9), SS3 (10), SS4(11), SS5 (12) Flash memory mgmt : data writing in Flash Memory(13) SPARE
DCG Configuration	4	39-42	Configuration of the Digital Chirp Generator xxyy: xx refer to the first band transmitted, yy to the second, if two frequencies are used. xx (or yy) = 00 -> B1; xx (or yy) = 01 -> B2 xx (or yy) = 10 -> B3; xx (or yy) = 11 -> B4 In AIS these bits are used as an address to select the requested row in the AIS frequencies table
PI-1 Band Selection	3	43-45	band selection for Passive Ionospheric Sounding (PIS) acquisition in the first 5 PRIs of the PIS slot PI-1 = 000 -> B0; PI-1 = 001 -> B1; PI-1 = 010 -> B2 PI-1 = 011 -> B3; PI-1 = 100 -> B4
PI-2 Band Selection	3	46-48	band selection for PIS acquisition in the second 5 PRIs of the PIS slot (see PI-1 Band Sel)
PIM_RX	1	49	PIM_RX = 0 -> PIS data from the dipole antenna PIM_RX = 1 -> PIS data from the monopole antenna
Ref_Alg_Sel	2	50-51	Ref_Alg_Sel = 0 -> in TRK use the default reference functions Ref_Alg_Sel = 01 -> in TRK use contrast method to evaluate the reference functions Ref_Alg_Sel = 10 -> in TRK use FSR method to evaluate the reference functions
LOL Logic MF	2	52-53	Xy: x refer to the first band transmitted, y to the second one.
Preset Tracking	1	54	PT = 0 -> acquisition/tracking operation PT = 1 -> preset tracking operation
F_NPM Address	2	55-56	Band of the Noise Power Measurement during ACQ f_NPM = 00 -> B1 f_NPM = 01 -> B2 f_NPM = 10 -> B3 f_NPM = 11 -> B4
Slope Address	4	57-60	binary 4 bit integer addressing among 16 available in PT the value to be assumed by the variable Slope Address
TX Power	4	61-64	The power level of the transmitted signal in count
A2_0 OST Abscissa	12	65-76	12 bit integer,. Values used to initialise the Contrast Method
Ind. Echoes or Flash Memory.	4	77-80	Individual Echoes and Flash Memory Management.
Consecutive frames in Flash Memory.	16	81-96	Number of echoes stored in Flash Memory

Table 2.4.1 – 1 Parameters and values contained in the Operation Sequence Table.

2.4.2 PARAMETER TABLE

The Parameters Table specifies values that apply to all Operational Modes and to the general behaviour of the instrument.



The Parameter Table is a permanent table that is stored in the MARSIS instrument, in contrast to the OST, which is uploaded for every orbit. This table stores parameters necessary for MARSIS operations and on-board data processing. Values of parameter table are documented in [AD03]. Some values in the PT are physical constants (e.g. speed of light) and some (e.g. coefficients for range to surface, radial and tangential velocity polynomials) are later reported as part of the ancillary data accompanying scientific data. Contents of the PT that are relevant for on-board processing are reported in the ancillary data of the instrument.

A default copy of the PT is maintained in a permanent memory area and it is loaded in the volatile portion of the memory upon instrument boot. During flight, it is possible to change or update the value of one or more parameters stored in the volatile copy of the PT, by means of a dedicated telecommand. It is also possible to update or change the value of parameters stored in the default copy of the PT, in the permanent memory, by means of the standard memory patch services.

2.5 DATA DESCRIPTION

In this section, the organization of scientific data produced by MARSIS will be discussed; this is relevant for the use of low-level data products, because their structure is identical to that of the scientific telemetry down-linked from the instrument.

MARSIS data are organized into groups of echoes called frames. A frame contains one or more echoes, with or without on-board processing. Each echo, depending on the kind of processing it underwent, is recorded either as a time series of signal samples, or as the complex spectrum of the signal itself produced by means of a FFT. Scientific data in a frame are complemented by a set of ancillary data, produced by the instrument and recording parameter values used in pulse transmission, echo reception and on-board processing.

2.5.1 FRAMES

A frame is a collection of received echoes with or without on-board processing, together with instrument ancillary information, and constitutes a single observation of the instrument.

The content of a frame depends on the operative mode of the instrument, and, for subsurface sounding only, on the state of the instrument (that is, if MARSIS was in acquisition or tracking phase) and on the processing path followed by the data (raw data in flash memory and individual echoes contain all echoes required for Doppler processing, while uncompressed data in flash memory and down-linked processed data contain only a fixed number of Doppler filters). Also, uncompressed data in flash memory and down-linked processed data frames contain Passive Ionosphere Sounding measurements. Furthermore, because the number of pulses used in Doppler processing is dependent on the altitude of the spacecraft (see [AD01]), frames of raw data in flash memory and individual echoes contain a variable number of echoes.

Ancillary data, produced by the instrument to record parameter values used in pulse transmission, echo reception and on-board processing, are available for all data, but those stored in flash memory have only limited information available (see [AD04]). It is perhaps worth reminding, however, that data passing through flash memory are the raw form of data downloaded also in processed form, for which full ancillary data are available.

The following table summarizes the structure of data frames according to instrument mode and state, and data processing form.

MARSIS Mode	State (Acronym)	Form (Acronym)	Number of Echoes or Filters	Passive Ionosphere Sounding	Ancillary Data
CAL RXO AIS	N/A	N/A	Fixed	No	Yes
SS1 SS2 SS3 SS4 SS5	Acquisition (ACQ) Tracking (TRK)	Compressed Data (CMP)	Fixed	Yes	Yes



SS1 SS2 SS3 SS4 SS5	Acquisition (ACQ) Tracking (TRK)	Individual Echoes (IND)	Variable	No	Yes
SS1 SS2 SS3 SS4 SS5	Acquisition (ACQ) Tracking (TRK)	Uncompressed Data (UNC)	Fixed	Yes	Reduced
SS1 SS2 SS3 SS4 SS5	Acquisition (ACQ) Tracking (TRK)	Raw Data (RAW)	Variable	No	Reduced

Table 2.5.1 – 1 Structure of MARSIS data frames according to instrument mode and state, and data processing form.

2.5.2 TIME SERIES AND SPECTRA

Within a frame, an echo is recorded either as a time series of signal samples, or as the complex spectrum of the signal itself produced by means of a FFT, depending on the kind of processing it underwent.

Calibration, Receive Only, Subsurface Sounding SS2, and Individual Echoes and Raw Data from all Subsurface Sounding modes report time series of measured echoes. Subsurface Sounding modes SS1, SS3, SS4 and SS5, both in compressed and uncompressed form, report spectra that have been processed on board. Each spectrum contains 512 real and 512 imaginary values for each of the Doppler filters, ordered as separate vectors (that is, all real values are listed before all imaginary values). Active Ionosphere Sounding and Passive Ionosphere Sounding report spectral power, that is values of signal power as a function of frequency: thus, the phase information that would allow reconstruction of the received signal through an inverse FFT is not sent to ground.

2.5.3 SAMPLE TYPES

Sample types inside a time series or spectrum depend on operative mode, instrument state and on-board processing. Table 3.5.3 - 1 describes all possible formats and lengths of individual samples.

Mode	State	Form	Data Type	Bytes
CAL	N/A	N/A	MSB_INTEGER	1
RXO	N/A	N/A	MSB_INTEGER	1
AIS	N/A	N/A	MSB_UNSIGNED_INTEGER	2
SS1 SS2 SS3 SS4 SS5	ACQ TRK	CMP	MSB_INTEGER	1
SS1 SS2 SS3 SS4 SS5	ACQ TRK	UNC	IEEE_REAL	4
SS1 SS2 SS3 SS4 SS5	ACQ TRK	RAW IND	MSB_INTEGER	1
PIS	N/A	N/A	MSB_UNSIGNED_INTEGER	2

Table 2.5.3 – 1 Formats and lengths of individual samples in time series or spectra, according to operative mode, instrument state and data form. Data types are defined according to [AD10].



2.6 DATA STRUCTURE

In the following sections, details of the structure and organization of data, as they are produced by the instrument, will be provided. This information is relevant for lowest-level data products, as data files are built by collecting and ordering in time instrument data frames without further editing or modification.

2.6.1 FRAME STRUCTURE

MARSIS data frames consist of up to two parts: the first contains ancillary data produced by the instrument, and used to interpret scientific data, and the second is science data themselves. Science data are organized into time series or spectra, and complex spectra are further subdivided into real and imaginary part.

Time series or spectra within the scientific data of a frame are ordered according to the time of acquisition. For processed data of Subsurface Sounding modes, which are produced using all echoes acquired during a frame, time series or spectra are ordered first according to the antenna through which they were received, then by transmitted band, and finally by Doppler filter. Only exception is the Operative Mode SS2, where the signal is transmitted to the ground already compressed in time and also after a multi-looking processing. In this case the 512 samples represent the power of the signals obtained with two different frequencies.

MARSIS DATA FRAME (SS1 MODE)							
DIPOLE F1 Doppler Filters (0)		DIPOLE F2 Doppler Filters (0)		MONOPOLE F1 Doppler Filters (0)		MONOPOLE F2 Doppler Filters (0)	
512 samples (8 bit/sa RE)	512 samples (8 bit/sa IM)	512 samples (8 bit/sa RE)	512 samples (8 bit/sa IM)	512 samples (8 bit/sa RE)	512 samples (8 bit/sa IM)	512 samples (8 bit/sa RE)	512 samples (8 bit/sa IM)

MARSIS DATA FRAME (SS2 MODE)	
DIPOLE F1 Multi-look	DIPOLE F2 Multi-look
512 samples (8 bit/sa RE)	512 samples (8 bit/sa RE)

MARSIS DATA FRAME (SS3 MODE)			
DIPOLE F1 Doppler Filters (-1, 0,1)		DIPOLE F2 Doppler Filters (-1,0,1)	
512 samples (8 bit/sa RE)	512 samples (8 bit/sa IM)	512 samples (8 bit/sa RE)	512 samples (8 bit/sa IM)

MARSIS DATA FRAME (SS4 MODE)			
DIPOLE F1 Doppler Filters (-2,-1, 0,1,2)		MONOPOLE F1 Doppler Filters (-2,-1,0,1,2)	
512 samples (8 bit/sa RE)	512 samples (8 bit/sa IM)	512 samples (8 bit/sa RE)	512 samples (8 bit/sa IM)



MARSIS DATA FRAME (SS5 MODE)			
DIPOLE F1 Doppler Filters (-1, 0,1)		MONOPOLE F1 Doppler Filters (-1,0,1)	
512 samples (8 bit/sa RE)	512 samples (8 bit/sa IM)	512 samples (8 bit/sa RE)	512 samples (8 bit/sa IM)

An exception to this ordering criterion is constituted by Passive Ionosphere Sounding data, which are attached at the end of the scientific data of a frame, as illustrated in Figure 2.6.1 – 1.

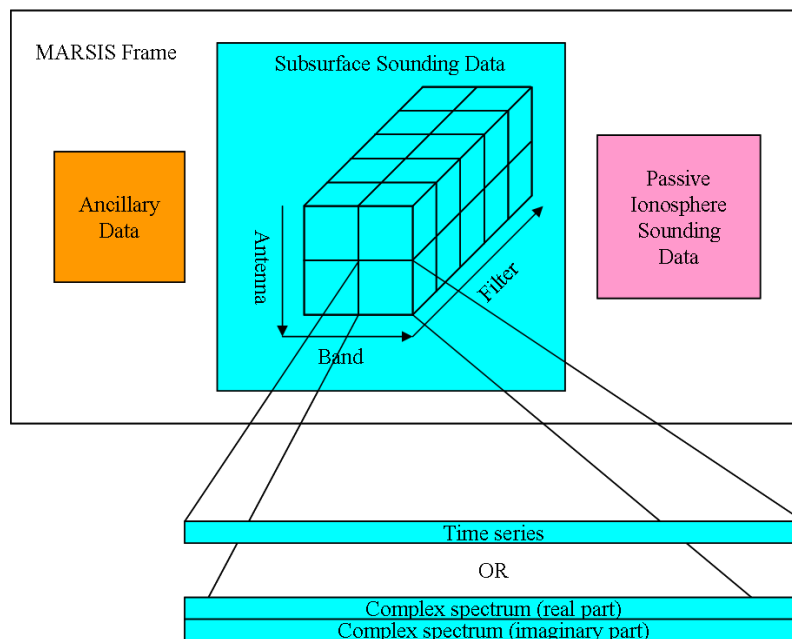

Figure 2.6.1 – 1 Scheme of the MARSIS Subsurface Sounding frame structure.

2.6.2 ANCILLARY DATA STRUCTURE BY INSTRUMENT MODE

Each frame of MARSIS data (with the exception of frames stored in flash memory) carries a 228 byte header of ancillary data, containing necessary information for subsequent analysis of the data and further processing. The exact content of the ancillary data depends on instrument mode.

There are four major structure types of the ancillary data : acquisition, tracking / individual echoes for subsurface modes, calibration / receive only and active ionosphere. Tables explaining parameters in these structures are shown in Appendix B.

2.6.3 SCIENTIFIC DATA STRUCTURE BY INSTRUMENT MODE

The structure of scientific data within a frame depends on operative mode, instrument state and on-board processing, resulting in a large number of different combinations: complete description of all possible formats can be found in Appendix C.



2.6.4 INDIVIDUAL ECHOES

A single frame of SSx tracking Individual Echoes contains a variable quantity of data. More precisely, a variable number of PRIs, being a PRI a fixed size data set (in general 980 bytes, with the exception of SS5).

- the following format is adopted inside the FRM file:

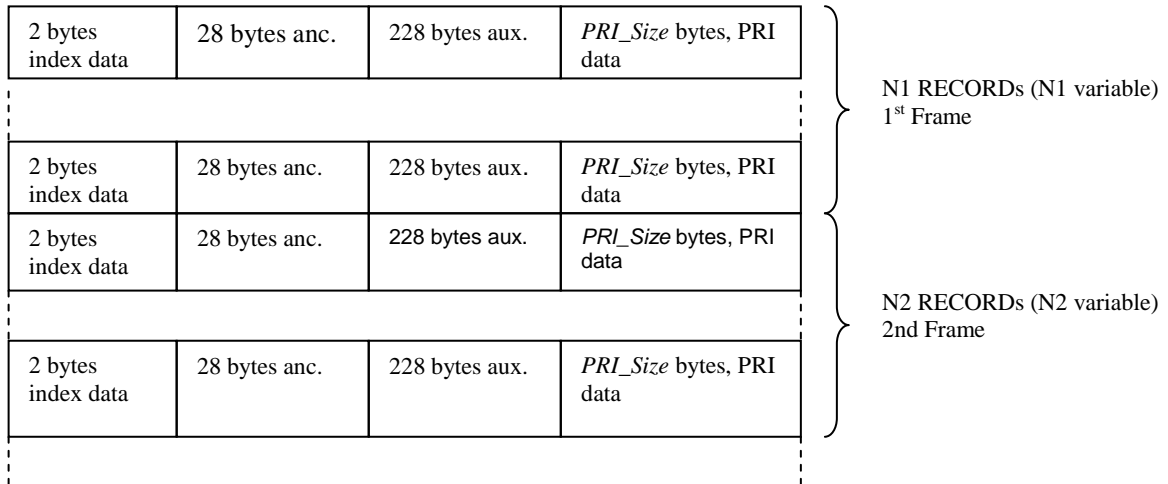

Figure 2.6.4 – 1 Scheme of the Individual Echoes frame structure.

Where index data (16 bits: 15, 14, ...1, 0) is formatted as follow:

- 10 bits (15-6): PRI number
- 6 bits (5-0):frequency/antenna (Dipole_F1, Dipole_F2, Monopole_F1, Monopole_F2)

The number of samples in an echo, called PRI_Size, is listed below:

Operative Mode	PRI_Size
SS1_TRK SS2_TRK SS3_TRK SS4_TRK	980
SS5_TRK SS1_ACQ SS2_ACQ SS3_ACQ SS4_ACQ SS5_ACQ	3920

Table 2.6.4 – 1 Scheme of the PRI_Size

2.6.5 FLASH MEMORY

The following data types may be stored for each SSx Operative Mode in Flash Memories (FM):

- RAW Tracking data
- RAW Acquisition data
- Uncompressed Tracking data
- Uncompressed Acquisition Data



Given the particular strategy adopted for writing data into FM ([AD04]-§7.6.6), the following storage format shall be considered: data are stored into FM as a single stream of bytes, being this stream a sequence of frames, each one of them is composed by an header followed by data themselves.

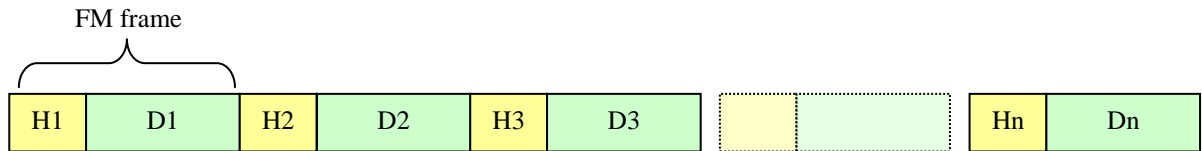

Figure 2.6.5 – 1 Scheme of the Flash Memory structure.

FM Frames differ from common Science Frame though. In general, a common Science Frame includes data collected from all Antennas/Frequencies involved in the selected Operative Mode.

For example, an SS1 Science Frame includes:

- Dipole F1 Data
- Dipole F2 Data
- Monopole F1 Data
- Monopole F2 Data

In case of FM, the same SS1 data are split into two separate Frames:

one FM Frame including:

- Dipole F1 Data
- Monopole F1 Data

another FM Frame including:

- Dipole F2 Data
- Monopole F2 Data

In general, a single Science Frame is always split into two FM frames.

Information on FM Frame data content are provided by the Frame header in fields BAND and CHANNEL (see [AD04]-§7.6-1).

The FM Frame header is also quite different from the Science Frame one: no Ancillary/Auxiliary data are present; there is only a 44 bytes header, (see [AD04]-§7.6-1)..



RAW data case

- the following format is adopted inside the FRM file:

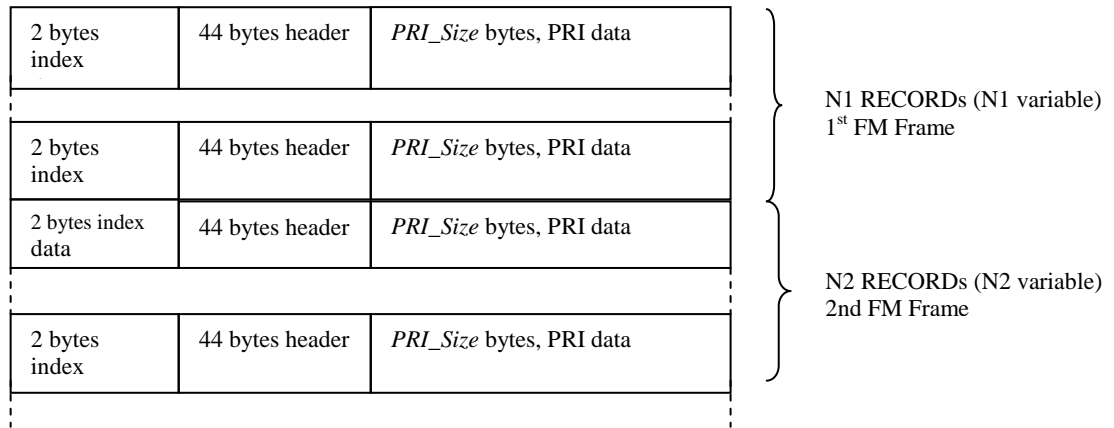

Figure 2.6.5 – 2 Scheme of the Flash Memory frame structure.

Where index data (16 bits: 15, 14, ... 1, 0) is formatted as follow:

- 10 bits (15-6): PRI number
- 6 bits (5-0): spare

The number of samples in an echo, called *PRI_Size*, is listed below:

Operative Mode	<i>PRI_Size</i>
SS1_TRK	1960
SS2_TRK SS3_TRK SS4_TRK	980
SS5_TRK SS1_ACQ SS2_ACQ SS3_ACQ SS4_ACQ SS5_ACQ	3920

*Table 2.6.5 – 1 Scheme of the *PRI_Size**



Uncompressed data case

- the following format is adopted inside the FRM file:

44 bytes header	<i>Op_Mode_Frame_Data_Size</i> bytes, PRI data	1 RECORD, 1 st FM Frame
44 bytes header	<i>Op_Mode_Frame_Data_Size</i> bytes, PRI data	1 RECORD, 2 nd FM Frame
⋮		

Figure 2.6.5 – 3 Scheme of the Uncompressed data frame structure.

Where the size in bytes of a frame, called *Op_Mode_Frame_Data_Size*, is listed below:

Operative Mode	Op_Mode_Frame_Data_Size
SS1_TRK SS1_ACQ SS2_ACQ SS3_ACQ SS4_ACQ SS5_ACQ	8192
SS2_TRK SS4_TRK	20480
SS3_TRK SS5_TRK	12288

Figure 2.6.5 – 2 Scheme of the PRI_Size.

2.7 DATA HANDLING PROCESS

Data products are generated by the MARSIS team according to the following scheme.

- The PI Institution (INFOCOM) receives the MARSIS instrument data records (Level 1a data) at the MARSIS data processing facility from the Mars Express Project Data Distribution System (DDS).
- From the raw data, INFOCOM generates Level 1b data files (including necessary ancillary data files) in agreed formats, and makes these data files available on the MARSIS ASDC server.
- The Level 1a and Level 1b data files are then automatically transferred to the Iowa MARSIS processing facility on a regular basis via the data mirroring function.
- Once made available on the MARSIS ASDC server, Level 1b data can be retrieved by authorized data users for scientific analysis. Data retrieval is performed by each data user by means of FTP.
- Subsurface data products of Level 2 and higher are generated at the data processing facility located in ThalesAlenia Space (MOC –Marsis Operation Center). Ionospheric data products of Level 2 and higher are generated at Iowa.
- Following internal validation, the Level 2 and higher level subsurface data products are made available on the MARSIS ASDC server, where can be retrieved by authorized data users for scientific analysis. Data retrieval is performed by each data user by means of FTP.
- Following internal validation, the Level 2 and higher level ionospheric data products are made available in the Iowa MARSIS processing facility for access via a Web browser-based display tool (restricted to authorized data users).
- The processed Ionospheric Sounding data products are made PDS-compliant, and, at approximately 6-month intervals, following final internal validation, are delivered to the MARSIS PI (INFOCOM) via the MARSIS ASDC server, as described in [AD01].



- On pre-defined dates, currently foreseen at 6-month intervals (see [AD06]), validated, PDS-compliant data of Level 1b and 2, both subsurface and ionosphere, are delivered to the ESA Planetary Science Archive by means of the ESA-provided tool PVV.

2.8 PRODUCT GENERATION

Level 1b processing starts from the telemetry data, as produced by the C&DH system on the spacecraft and passed to the telemetry subsystem: data are still in the form of transfer frame packets organised by contacts or ground tests data. Processing starts by cleaning, merging and time-ordering the packets. This means that duplicate data have been deleted, missing packets are padded out, and the data are organised by orbits. Data then need to be sorted by instrument data types and instrument modes.

MARSIS Level 1b processing orders data in a useful way for the intended users (i.e. radar scientists) and applications (i.e. quick look to monitor hardware performance and higher-level processing), altering and manipulating them as little as possible to avoid the risk of introducing errors and, at the same time, including all necessary information from all relevant sources. Level 1b data are in scientifically useful form, i.e. individual spectra. These data are still uncalibrated.

MARSIS Level 1b data products consist of the data produced by the instrument reconstructed from the scientific telemetry, sorted by instrument state and data type, and provided with spacecraft position, velocity and attitude information. Any other spacecraft telemetry relevant for calibration and processing (e.g. temperature of the receiver) is also included.

Level 1b processing requires the acquisition of MARSIS scientific telemetry and any relevant spacecraft auxiliary data from the Mars Express Data Disposition System (DDS) in ESOC, and of SPICE kernels describing the spacecraft state and attitude from the Auxiliary Data Conversion System (ADCS) in ESTEC.

Both instrument telemetry and ancillary data are stored at the PI processing facility as they accumulates over the course of the mission, to provide the capability to reprocess data in case of errors or to accommodate new information referring to existing data sets.

Level 1b data distribution to the Co-Is and to the Mars Express mission archive is performed by ASDC. It is required by ESA that data products are delivered in batches of six-months worth of data within six months from the last data take (i.e. one year after the beginning of that particular data collection period), but it is necessary that level 1b processing be completed in a much shorter period, to allow enough time for level 2 data processing and data analysis within the MARSIS team before the expiration of the data proprietary period (which is the same six-month time span).

2.9 OVERVIEW OF DATA PRODUCTS

2.9.1 PRE-FLIGHT DATA PRODUCTS

Because of its 40m long antenna, it was not possible to fully test MARSIS on ground in conditions that can be considered representative of actual operations: thus, the MARSIS team does not plan to release pre-flight data products, as they would be useless for the analysis and interpretation of data acquired at Mars.

2.9.2 SUB-SYSTEM TESTS

Sub-system tests performed on MARSIS are useful only for engineering purposes: thus, the MARSIS team does not plan to release sub-system test data products, as they would be useless for the analysis and interpretation of data acquired at Mars.



2.9.3 INSTRUMENT CALIBRATIONS

Calibration runs of the instrument involved mainly the determination of the instrument performance at different temperatures, where it was found that the instrument receiver is indeed sensitive to temperature. Data accumulated during on-ground tests are thus used for the calibration of scientific data, but they are not released as a separate data set. Rather, they have been processed to produce calibration files that are part of standard data product releases.

2.9.4 IN-FLIGHT DATA PRODUCTS

Data sets are homogeneous in terms of processing level of the data, and can thus be classified according to the definition of Processing Levels for Science Data Sets contained in [AD06]. Currently, two levels of processing are foreseen for MARSIS data:

- Level 1b: telemetry data that have been cleaned and merged, time ordered, sorted by instrument data types and instrument modes. Data are in scientifically useful form, but still uncalibrated.
- Level 2: Level 1b with calibration and corrections applied to yield data in scientific units.

Level 1b data are also called Experiment Data Records (EDR's for short), Level 2 data Reduced Data Records (RDR's).

The resulting list of data sets, together with their official names defined according to the PDS standard used for their archiving [AD10], is provided in the table below.

Data Set	Data Set Name
Level 1b	MARS EXPRESS MARS MARSIS EXPERIMENT DATA RECORD V1.0
Level 2 Subsurface Sounding	MARS EXPRESS MARS MARSIS REDUCED DATA RECORD SUBSURFACE V1.0

Table 2.9.4 – 1 MARSIS Data Sets.

2.9.5 ANCILLARY DATA USAGE

Ancillary data used in MARSIS data product generation are needed to correctly reference observations in space and time. Geometric information accompanying instrument data is produced by means of software based on the SPICE library, released by the Navigation and Ancillary Information Facility (NAIF) of JPL. Spacecraft trajectory and attitude data produced by ESOC is thus accessed through the SPICE library in the form of pre-processed data files (called kernels) produced by NAIF according to the standards described in [AD07].

3 ARCHIVE FORMAT AND CONTENT

This section describes the features of the MARSIS Standard Product Archive volumes, including the file names, file contents, and file types, which apply to all MARSIS data sets. Specialization of this information to each single data set is provided in Section 4.



3.1 FORMAT AND CONVENTIONS

3.1.1 DELIVERIES AND ARCHIVE VOLUME FORMAT

Delivery of data from the MARSIS team to the PSA for archiving is done through the Internet, according to the incremental data release concept described in [AD12]. In conformity with guidelines also provided in [AD12], data are organized so that one MARSIS data set coincides with a single logical volume, as defined in the PDS standard [AD10]. For the nominal mission the Data Set ID is showed in Table 3.1.1-1:

Data Set Name	Data Set ID	Volume ID
MARS EXPRESS MARS MARSIS EXPERIMENT DATA RECORD V1.0	MEX-M-MARSIS-2-EDR-V1.0	IT_URM1_DINF_MEXME
MARS EXPRESS MARS MARSIS REDUCED DATA RECORD SUBSURFACE V1.0	MEX-M-MARSIS-3-RDR-SS-V1.0	IT_URM1_DINF_MEXMRS

Table 3.1.1 – 1 MARSIS Data Sets, Data Set ID's and corresponding Volume ID's.

For extended phases of the mission beyond its nominal duration, Data Set Names and Data Set ID's are changed to denote that they refer to data from the extended mission:

Data Set Name	Data Set ID
MARS EXPRESS MARSIS EDR DATA EXTENSION_y V1.0	MEX-M-MARSIS-2-EDR-EXTy-V1.0
MARS EXPRESS MARSIS RDR SUBSURFACE DATA EXTENSION_y V1.0	MEX-M-MARSIS-3-RDR-SS-EXTy-V1.0

Table 3.1.1 – 2 MARSIS Data Set Names and Data Set ID's for extended mission phases.

Where “y” is an integer number used to identify the extended mission phase.

3.1.2 DATA DIRECTORY NAMING CONVENTION

Because it is expected that a large number of data files is present on a volume, the directory containing them is further divided into a number of subdirectories, each containing data collected over ten orbits. These subdirectory are named so as to make clear which data products they contain and when such data were collected. Their name is in the form **pppooX**, where **ppp** is a group of letter denoting the kind of data product contained in the subdirectory (EDR for Experiment Data Records, RDR for Reduced Data Records,), and **ooo** are the digits common to numbers of the orbits in which data were acquired: for example, the subdirectory named EDR188X contains all files of Level 1b data collected from orbit 1880 to orbit 1889.

3.1.3 FILE NAMING CONVENTION

All data product files throughout different MARSIS data sets are named using the same file naming convention. File names are built by a concatenation of three-letter components separated by underscore characters (“_”). Each component provides one type of information on the content of the file. Components are concatenated in the following order, although not all of them are necessarily present in any given file name:

<File type>_<Operative mode>_<Instrument state>_<Data form>_<Data product>_<Orbit Number>.<Extension>

File type refers to the type of data file: as it will be detailed in the following sections, MARSIS data products can consist of up to two files each, the first of which contains the data proper, and is called a “frame file” (the corresponding component is FRM), while the second, called a “geometry file” (GEO in short) contains geometric information used to locate observations in space and time.



Operative modes, instrument states, data forms and data product types have been defined in Section 2, while the orbit number is a four-digit number identifying an orbit according to rules defined by the Mars Express mission control.

File extension defines the format of data contained in the file: the extension is usually “.DAT”, denoting that the file contains a binary table object (data objects are defined according to [AD10]).

Permitted values for different file name components are listed in the table below.

Type	Mode	State	Form	Product	Orbit	Extension
FRM GEO	CAL RXO AIS SS1 SS2 SS3 SS4 SS5	ACQ TRK	RAW IND UNC CMP	EDR RDR	four-digit orbit number	.DAT

Table 3.1.3 – 1 File name components for MARSIS data product files: refer to Section 1.7 for an explanation of the meaning of acronyms.

As it will be illustrated in section dealing with naming schemes applied to individual Data Sets, the maximum length of data files will never exceed the 27 character limit, as not all name components listed in Table 3.1.3 – 1 are used in each individual file name.

3.1.4 SPECIAL OBSERVATION : PHOBOS

The data products relative to Phobos have the same content and structure as the standard data products, the difference being only a different naming convention. The files names are built using standard rules, adding the suffix “_PH”.

Type	Mode	State	Form	Product	Orbit	Suffix	Extension
FRM GEO	CAL RXO AIS SS1 SS2 SS3 SS4 SS5	ACQ TRK	RAW IND UNC CMP	EDR RDR	four-digit orbit number	PH	.DAT

Table 3.1.4 – 1 File name components for MARSIS data product files :PHOBOS

3.2 STANDARDS USED IN DATA PRODUCT GENERATION

3.2.1 PDS STANDARDS

All data released by the MARSIS Team for archiving are required to be compliant with the Planetary Data System (PDS) standard [AD09, AD10, AD11]. This standard imposes requirements on several aspects of the data product generation



process, among which there is need for detailed documentation describing the origin, structure and processing undergone by data, for their accurate location in space and time, and in general for all auxiliary and ancillary data which are needed for the scientific use of the data product. Also, such information has to be provided in an Object Description Language (ODL), in the format *keyword = value*, where *keyword* is a standard term used to label a parameter (e.g. latitude), and *value* is any allowed information quantifying that parameter.

3.2.2 TIME STANDARDS

3.2.2.1 START_TIME AND STOP_TIME FORMATION

The PDS formation rule for dates and time in UTC is: YYYY-MM-DDThh:mm:ss.fff or YYYY-DDDThh:mm:ss.fff, with

- YYYY year (0000-9999)
- MM month (01-12)
- DD day of month (01-31)
- DDD day of year (001-366)
- T date/time separator
- hh hour (00-23)
- mm minute (00-59)
- ss second (00-59)
- fff fractions of second (000-999) (restricted to 3 digits)

3.2.2.2 SC_CLOCK_START_COUNT AND SC_CLOCK_STOP_COUNT

The SC_CLOCK*COUNTS represents the on-board time counters (OBT) of the spacecraft and instrument computers. This OBT counter is given in the headers of the experiment telemetry source packets. It contains the data acquisition start time as 32 bit of unit seconds followed by 16 bit of fractional seconds. The time resolution of the fractional part is $2^{-16} = 1.52 \times 10^{-5}$ seconds. Thus the OBT is represented as a two integer numbers separated by a point, the first of which represents the integer part of the clock count, and the second of which represents the fractional second part of the clock count. A reset of the spacecraft clock is represented by an integer number followed by a slash, e.g. "1/" or "2/".

Example 1: SPACECRAFT_CLOCK_START_COUNT = "1/21983325.39258"

Example 2: SPACECRAFT_CLOCK_START_COUNT = "21983325.39258"

Example 3: SPACECRAFT_CLOCK_START_COUNT = "2/0000325.39008"

Example 1 and Example 2 represents the same time instance.

3.2.2.3 OBT TO UTC TIME CONVERSION

Universal Time Coordinate (UTC) is a function of the time correlation packages and the on-board time. The time correlation packages are archived and distributed in the SPICE auxiliary data set and contain a linear segments that map the on-board time to UTC time. The linear segment is represented by a time offset and a time gradient. The conversion function is:

Time in UTC = offset + (OBT(seconds) + (OBT(fractional part) * 2^{-16})) * gradient



3.2.3 REFERENCE SYSTEMS

Locations on the surface of Mars are expressed in planetocentric coordinates. Longitude is comprised in the range 0° – 360°.

3.3 DATA VALIDATION

Validation of data is performed at different levels of detail and using different procedures. A dedicated tool, called Monitoring Tool, exists in the MARSIS ground segment software to verify the completeness of data received from the spacecraft. Simple control of the syntax of data product labels and of the correct implementation of the directory structure is performed by means of software tools available from PDS. Finally, scientific validation of the data takes place during the proprietary period as MARSIS Co-I's perform their scientific analysis and examine in detail the content of each data product.

3.4 CONTENT

This section contains all the information that is data product- and detector-independent but is usually the same for all data sets.

3.4.1 VOLUME SET

As the concept of a volume as defined in the PDS standard is based on physical media, e.g. CD-Rs, the PSA does not use the name volume. Instead, the concept of deliveries is defined for the PSA and the term delivery is used for the PSA. However, here and in the following sections we will use the word “volume” to refer to a standard PDS directory structure for a data set in which the entire data set consists of a single (virtual) volume. Different MARSIS data sets are organized as separate virtual volumes, and the concept of volume set is not used.

3.4.2 DATA SET

MARSIS data sets are organized into one data set on one virtual volume, using the standard PDS volume structure. Such structure is described in Section 19.3 of [AD10], and shown in the figure below.

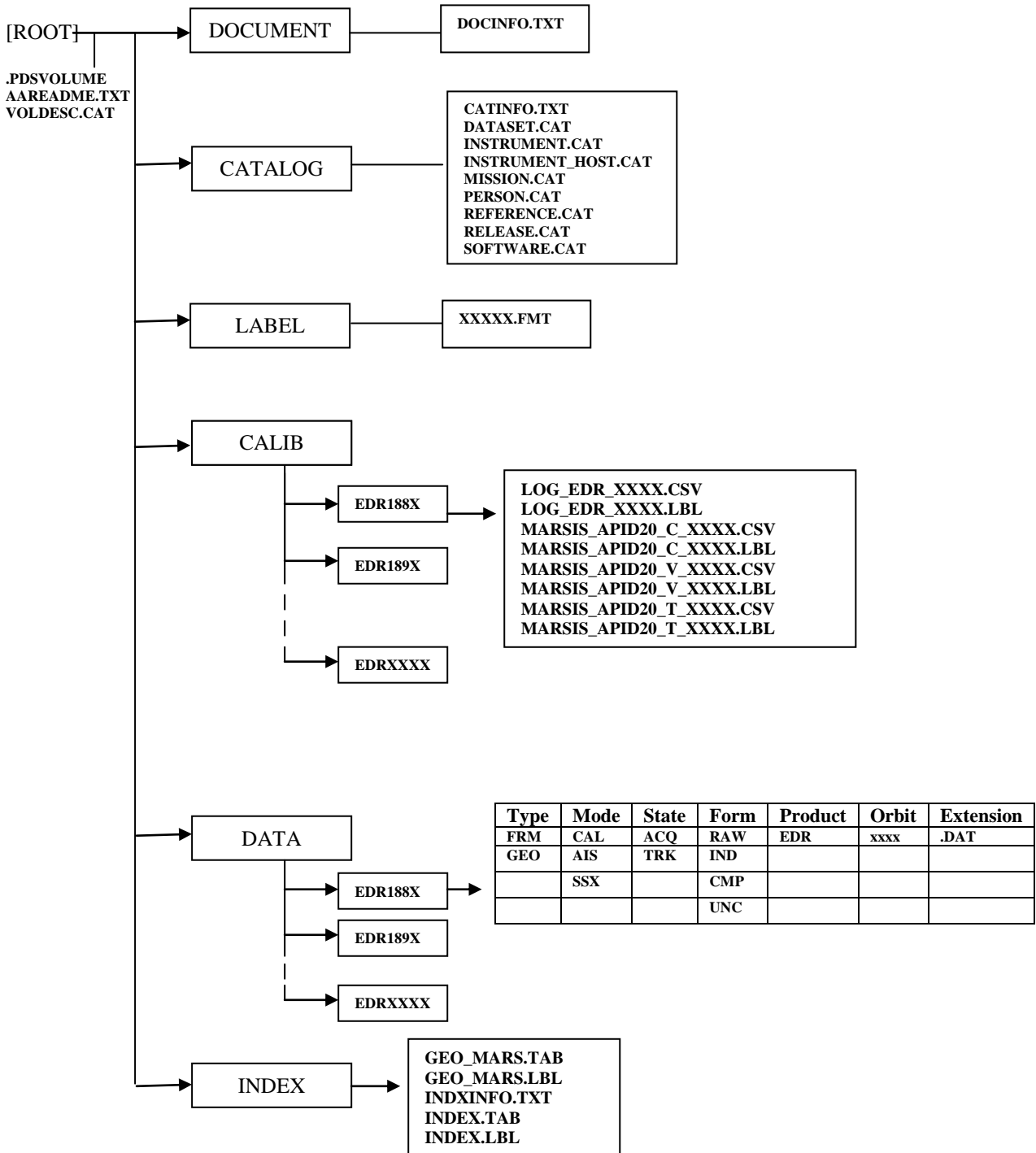

Figure 3.4.2 – 1 Standard PDS volume set organization: one data set, one volume.

The content of each directory shown in Figure 3.4.2 – 1 is detailed in the following sections.



3.4.3 DIRECTORIES

3.4.3.1 ROOT DIRECTORY

Files in this directory are provided by the MARSIS science team.

File Name	File Contents
AAREADME.TXT	Volume content and format information
VOLDESC.CAT	Description of the contents of the volume in a PDS format readable by both humans and computers

Table 3.4.3.1 – 1 Files located in the root directory of a MARSIS data volume.

3.4.3.2 INDEX DIRECTORY

This directory contains indexes, that is files with information that allows a user to locate data of interest. Within the Planetary Science Archive (PSA), index files fulfil two more purposes. First, some index files are read by database software and allow the ingestion of additional parameters into the database. Secondly, the PSA is using the index files to check for correct deliveries of data set releases and revisions into the PSA. Indexes are written as INDEX_TABLE objects, that is a specific type of PDS ASCII TABLE objects, and are provided with detached PDS label files.

All index files below the INDEX directory within a data set release are unique and are valid for the actual data set and all previous ones. This means that the content of an index file covers all previous data set releases. The set of index files for MARSIS, as required in [AD12], is:

File Name	File Contents
INDXINFO.TXT	Text description of the directory contents
INDEX.LBL	Detached PDS label to describe INDEX.TAB
INDEX.TAB	PDS table, listing all files in the DATA directory for the corresponding release and revision.
GEO_MARS.LBL	Detached PDS label to describe GEO_MARS.TAB
GEO_MARS.TAB	PDS table, listing geometric properties of all data products in the DATA directory for the corresponding release and revision.

Table 3.4.3.2 – 1 Files located in the INDEX subdirectory of a MARSIS data volume.

All index files are patterned according to the standards defined in [AD10], the only difference being the name of the individual columns forming the INDEX_TABLE.

The GEO_MARS.TAB file includes all the geometrical and position information listed in [AD14]. This file contains one entry for every frame acquired by the instrument (such entry is called a “line”), and each entry provides values for line description parameters, certain required non-geometrical parameters, generic position parameters, geometry and position information, solar related parameters, spacecraft related parameters and instrument viewing related parameters

3.4.3.3 DOCUMENT DIRECTORY

Files in this directory are provided by the MARSIS science team, and will remain the same across different volumes.



File Name	File Contents
DOCINFO.TXT	Text description of the directory contents
MARSIS_EAICD.LBL	PDS label for MARSIS_EAICD.TXT and MARSIS_EAICD.PDF
MARSIS_EAICD.TXT	MARSIS EAICD (this document) in plain ASCII text form
IMAGExxx.PNG	PNG files containing figures and tables for MARSIS_EAICD.TXT. xxx is a 3-digit number.
MARSIS_EAICD.PDF	MARSIS EAICD (this document) in PDF format
MARSIS_FUM.LBL	PDS label for MARSIS_FUM.PDF
MARSIS_FUM.PDF	MARSIS Flight User Manual, Issue 3, INFOCOM ID-MAR-0008-INF, 18 December 2003 [AD01]
MARSIS_OST.LBL	PDS label for MARSIS_OST.PDF
MARSIS_OST.PDF	MARSIS DES Operation Sequence Table, Issue 1, LABEN TL 19392, 29 January 2003 [AD02]
MARSIS_PT.LBL	PDS label for MARSIS_PT.PDF
MARSIS_PT.PDF	MARSIS DES Parameters Table, Issue 3, LABEN TL 18546 [AD03]
MARSIS_PSD.LBL	PSD label for MARSIS_PSD.PDF
MARSIS_PSD.PDF	MARSIS Packet Structure Definition, Issue 6, LABEN TL 16927, 3 February 2003 [AD04]

Table 3.4.3.3 – 1 Files located in the DOCUMENT subdirectory of a MARSIS data volume.

This directory contains additional documentation provided for a better understanding of the data and their use.

3.4.3.4 LABEL DIRECTORY

This directory contains files referred to by ^STRUCTURE pointers included in labels of files in the DATA subdirectory. The content of these files is the description in ODL language of PDS Data Objects contained in Data Product files themselves. As it will be detailed in Section 4.1, MARSIS Data Products consist of tables, and the content of this directory is the description of table columns for different Data Product file types.

There is one file for each Data Product file type. These files have a .FMT extension, and are named according to the file naming convention described in Section 3.1.3, without the use of a four-digit orbit number or a ten-digit spacecraft clock count. For example, the table format description file for a data product file named FRM_SS1_TRK_CMP_EDR_XXXX.DAT (where XXXX can be any orbit number) is called FRM_SS1_TRK_CMP_EDR.FMT.

3.4.3.5 CATALOG DIRECTORY

Files in this directory are catalogue files, that is files containing PDS catalogue objects. Such objects provide high-level information suitable for loading into a database to facilitate searches across data sets, collections and volumes.

The catalogue objects included on a PDS volume also provide local, high-level documentation. The full set of catalogue objects, listed below, is required in the CATALOG directory of every PDS archive volume.

Such files are provided by the MARSIS science team, with the concurrence of the PSA.

File Name	File Contents
CATINFO.TXT	Text description of the directory contents
MISSION.CAT	PDS catalogue object for the mission
INSTHOST.CAT	PDS catalogue object for the spacecraft
INST.CAT	PDS catalogue object for the instrument



DATASET.CAT	PDS catalogue object for the MARSIS data set
PERSON.CAT	PDS catalogue object for key persons involved in MARSIS
REF.CAT	PDS catalogue object for references appearing in the documentation
SOFT.CAT	PDS catalogue object for the software distributed with the data set
RELEASE.CAT	PDS catalogue object for current release and revision status of the data set

Table 3.4.3.5 – 1 Files located in the CATALOG subdirectory of a MARSIS data volume.

3.4.3.6 CALIB DIRECTORY

The CALIB directory contains instrument performance reports and engineering telemetry data tables relative to data in the current Data Set. It is organized into subdirectories named according to the same scheme used for subdirectories in the DATA directory (see Section 3.1): thus, for example, all data anomaly reports for orbits 1885-1889 in the EXPERIMENT DATA RECORD Data Set (see Table 2.9.4 - 1) are contained in a CALIB subdirectory named EDR188X.

The reports themselves are in the form of detached-label Spreadsheet Data Objects, called logs. Each row in a log lists the value of a number of parameters identifying a data take, describing the quality of the data, and some geometric information provided for ease of reference. The log themselves are contained in files named LOG_ddd_nnnn.CSV, where:

- **ddd** is an identification of the data set they belong to,
- **nnnn** is the number of the orbit for which a log is provided.

For example, the instrument performance report for orbit 1886 in the EXPERIMENT DATA RECORD Data Set is contained in the CALIB subdirectory EDR0188X and is named LOG_EDR_1886.CSV. The file containing the corresponding detached label is called LOG_EDR_1886.LBL

For subsurface data sets of higher processing level than EDR's (see Table 2.9.4 - 1), the CALIB directory contains reports describing the outcome of processing applied to lower-level data to produce the current data set, in a format similar to the one just described. Furthermore, calibration files used in producing the current data set are also provided, together with information on their use.

In the REDUCED DATA RECORD SUBSURFACE Data Set, processing consists essentially in range processing, i.e. correlation of the received signal with the transmitted waveform (see Section 2.3.4). The distortion introduced by the ionosphere makes so that even the echo from an ideal mirror-like surface will not be identical to the transmitted pulse, so that modelling is necessary to predict the distortion caused by the ionosphere under different solar illumination conditions and in different locations. From the processing point of view, this results in a set of functions used for correlation with the received echo, each of which is appropriate under certain conditions. Thus, in the CALIB directory, this set of functions is provided together with explanations of how they are to be used.

In the CALIB directory there are also files reporting engineering parameters of the instrument, called MARSIS_APID20_C_yyyy.CSV, MARSIS_APID20_T_yyyy.CSV, MARSIS_APID20_V_yyyy.CSV files where yyyy is the number of the orbit. These spreadsheets report respectively currents, temperatures and voltages measured within the instrument during a single orbit. The files containing the corresponding detached label MARSIS_APID20_C_yyyy.LBL, MARSIS_APID20_T_yyyy.LBL, MARSIS_APID20_V_yyyy.LBL

3.4.3.7 DATA DIRECTORY

The DATA directory contains actual data products generated by the MARSIS team. Data files are organised into subdirectories, each containing data collected over ten orbits. Subdirectories in the DATA directory is named according to the scheme described in Section 3.1.3.

An example of the organisation of the DATA directory into subdirectories is provided in section 3.1.



4 DETAILED INTERFACE SPECIFICATIONS

4.1 STRUCTURE AND ORGANISATION OVERVIEW

As discussed in Section 2.9.4, MARSIS data sets are homogeneous in terms of processing level of the data, and, with the exception of lowest-level data, of the type of observation (i.e. either subsurface or ionosphere):

- Level 1b data (Data Set MARS EXPRESS MARS MARSIS EXPERIMENT DATA RECORD V1.0) consists of the instrument telemetry correlated with the auxiliary information needed to locate observations in space and time. Level 1b data users are mainly radar scientists interested in redoing the entire processing of the received signal, while the fact that unprocessed Subsurface Sounding echoes do not show any obvious indication of subsurface interfaces makes EDR's of little use for geologists.
- Level 2 Subsurface Sounding data (Data Set MARS EXPRESS MARS MARSIS REDUCED DATA RECORD SUBSURFACE V1.0) consists of Level 1b data that have been processed to produce calibrated echoes of subsurface reflections: thus, they are the data set of choice for geological analysis of the structure and layering of the Martian subsurface.

MARSIS raw data are processed to produce Level 1b data, i.e. data which have been edited, and provided with auxiliary information to locate them in space and time. Level 1b data differ from raw data in that they have extra files providing auxiliary information on spacecraft position, observation geometry and the like that cannot be derived from MARSIS data alone.

Level 1b data are further processed to produce Level 2 data, i.e. data which have been calibrated, range-compressed and corrected for ionosphere distortion. Auxiliary information for Level 2 data is not modified, and thus the volume of auxiliary data accompanying Level 2 data is the same as for Level 1b data. Scientific data, however, are converted from 1-byte integer counts from the analogue-to-digital converter of the instrument to 4-byte real voltages, producing an increase of science data volume by a factor of four.

As already described in Section 3.1.1, data products within a Data Set are organised into subdirectories, each containing data collected over ten orbits. Subdirectories in the DATA directory are named according to the scheme described in Section 3.1.2. In Figure 3.4.2 – 1 the structure of the DATA directory for the MARS EXPRESS MARS MARSIS EXPERIMENT DATA RECORD V1.0 Data Set is shown for illustration.

Data organization remains the same for all MARSIS Data Sets. The only difference is the group of three letters preceding the orbit number in the naming of subdirectories: EDR is changed to RDR for MARS EXPRESS MARS MARSIS REDUCED DATA RECORD SUBSURFACE V1.0 Data Sets.

Each MARSIS Data Product is an aggregation of MARSIS frames. A frame is a collection of received echoes with or without on-board processing, and constitutes a single observation of the instrument.

Each Data Product contains data from one or more frames collected using the same operation mode, instrument status and on-board processing scheme. Thus, the content of each MARSIS data product is highly variable in terms of number of frames, and depends on how operations for the instrument were planned during a given data collection period.

Because each frame is a sequence of time samples of a received signal, complemented by auxiliary information, the natural organization for frames within a Data Product is a table, in which each line contains data from a single frame, and each column contains the value of a single parameter or time sample across different frames.

Each Data Product consists of up to two files: a binary file containing the data themselves, and a binary table of quantities describing the geometry of observation, generated on-ground from spacecraft navigation data. Each Data Product file is described by an attached PDS label. Format files for table data objects contained in data files, of which several exist according to operation mode, instrument status and on-board processing scheme, are contained in the LABEL directory of each Data Set Volume.



A PDS label provides descriptive information about the associated file. The PDS label is an object-oriented structure consisting of sets of 'keyword = value' declarations. PDS labels for all MARSIS Data Sets have the same standardised structure that is used for all labels (see , Appendix A and Appendix E for details on each keyword).

4.2 EXPERIMENT DATA RECORD DATA SET: DEFINITION AND CONTENT

The MARS EXPRESS MARS MARSIS EXPERIMENT DATA RECORD V1.0 Data Set contains scientific telemetry generated by the instrument, edited to remove duplications, zero-padded for missing packets, and correlated with geometric information needed to locate observations in space and time. No other kind of processing is applied to the data.

Because of this, subsurface sounding data for all modes except SS2 need to be range-processed (see Section 2.3.4) before subsurface reflections can be detected. In Figure 4.2 – 1 a simulated subsurface echo is shown before range processing to illustrate the point: the plot represents the power received by the instrument as a function of time, and vertical bars mark instants of time in which echoes from each subsurface layer reach the radar. It can be seen that, before on-ground range processing, the received echo does not bear any obvious indication of the existence of subsurface layers.

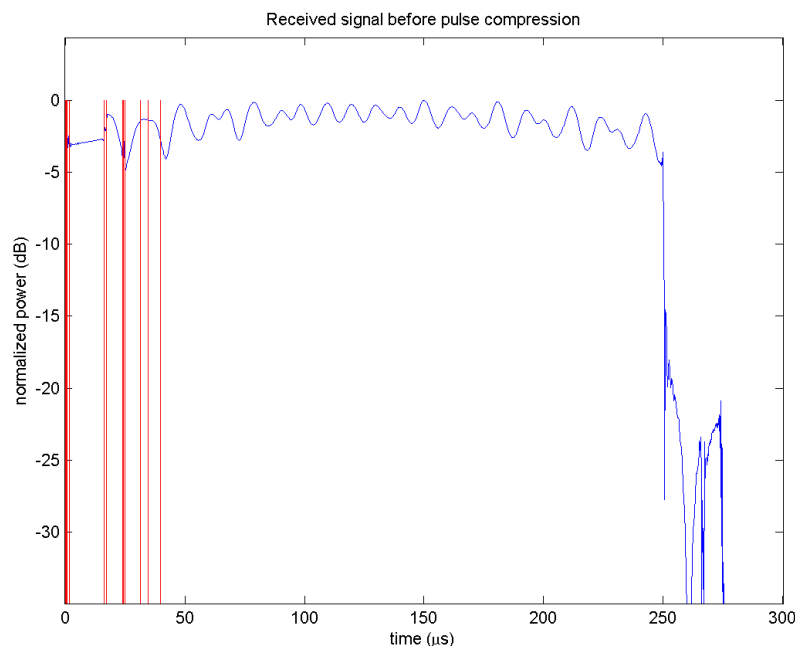

Figure 4.2 – 1 Plot of a received unprocessed echo produced by means of a simple one-dimensional simulation of signal propagation through a plane parallel stratigraphy. Red vertical bars mark instants of time in which echoes from each subsurface layer reach the radar.

This Data Set contains all different data types produced by the instrument described in Section 2.3.12. Within a Data Product, the structure of individual frames is not modified, and is thus the one described in Sections 2.5 and 2.6.

Data Products need to accommodate the very different data structures resulting from the different modes and states of the instrument, and from the method used in on-board processing. Thus, there are several types of Data Products in this data Set, which are listed in the table below.



Data Product Type	Description
AIS_EDR	Active Ionosphere Sounding data frames with geometry information
CAL_EDR	Data frames acquired in Calibration mode with geometry information
RXO_EDR	Data frames acquired in Receive Only mode with geometry information
SSx_yyy_CMP_EDR	On-board-processed Subsurface Sounding data (either in Acquisition or Tracking state) with geometry information
SSx_yyy_IND_EDR	Individual Echoes from Subsurface Sounding data (either in Acquisition or Tracking state)
SSx_yyy_UNC_EDR	Uncompressed Subsurface Sounding data (either in Acquisition or Tracking state)
SSx_yyy_RAW_EDR	Raw Subsurface Sounding data (either in Acquisition or Tracking state)

Table 4.2 – 1 List of EDR data Products. The “x” used in the Data Product Types column stands for a number between 1 and 5, while “yyy” stands either for ACQ or TRK (See Section 3.1.3 for explanations).

Data Product files are named according to the convention defined in Section 3.1.3. As it will be described in the following section, AIS_EDR, CAL_EDR, RXO_EDR and SSx_yyy_CMP_EDR Data Product files contain data acquired throughout a single orbit, and are thus identified by a four-digit orbit number, while SSx_yyy_IND_EDR, SSx_yyy_UNC_EDR and SSx_yyy_RAW_EDR Data Product files contain data from a single frame, and are thus named after the ten-digit spacecraft clock count at the time of data acquisition. Furthermore, AIS_EDR, CAL_EDR, RXO_EDR and SSx_yyy_CMP_EDR Data Products possess geometric information that is written in a separate file, and thus each Data Product consists of a file containing instrument frames (FRM file) and one containing geometric information (GEO file).

4.3 EXPERIMENT DATA RECORD DATA PRODUCT DESIGN

4.3.1 AIS_EDR, CAL_EDR, RXO_EDR AND SSX_YYY_CMP_EDR DATA PRODUCT DESIGN

AIS_EDR, CAL_EDR, RXO_EDR and SSx_yyy_CMP_EDR Data Products are made by two files, each of which contains a PDS binary TABLE object preceded by a PDS attached label describing its structure. The first file, called Frame file (FRM) contains the instrument data proper, exactly in the same format (bit by bit) as they were produced by the instrument (see Sections 2.5 and 2.6 for a complete description). Each frame corresponds to a record in the file, which is also a row in the PDS binary TABLE object into which frames are organised.

A Data Product contains all frames acquired using the same instrument mode, in the same instrument state and after the same type of on-board processing during a single orbit. The resulting structure, for the specific case of subsurface sounding data is illustrated in Figure 4.3.1 - 1.

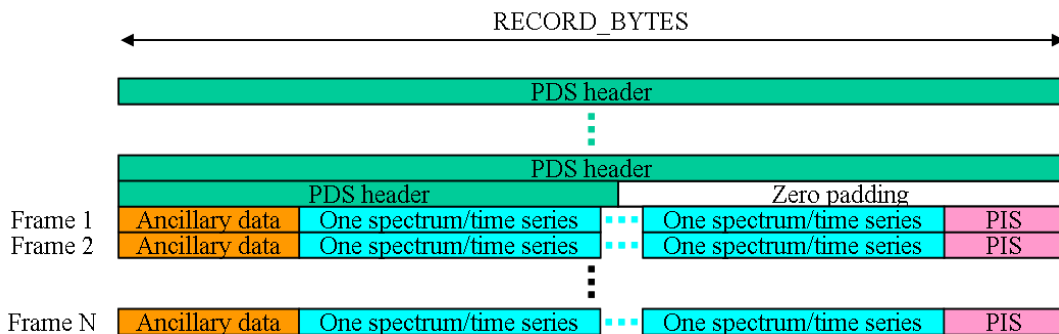

Figure 4.3.1 – 1 FRM file structure for subsurface data.

Ancillary data for different instrument modes are listed and explained in Appendix B, while the structure of scientific data is described in Appendix C.



In Figure 4.3.1 – 1, the zero padding refers to the requirement for a PDS attached label to have a length which corresponds exactly to an integer number of records; if this length is constant: in the case shown in Figure 4.3.1 – 1, the size of a record is the size of the frame for that particular data type. To this end, the label is padded with space characters (ASCII 32 decimal) by adding spaces after the label's END <CR><LF> statement and before the data so that the total of the label (in bytes) is an integral multiple of the record length of the data. Thus, the LABEL_RECORDS keyword in the label (see Appendix E) is calculated by dividing the total padded length of the label section, in bytes, by the stated value of RECORD_BYTES.

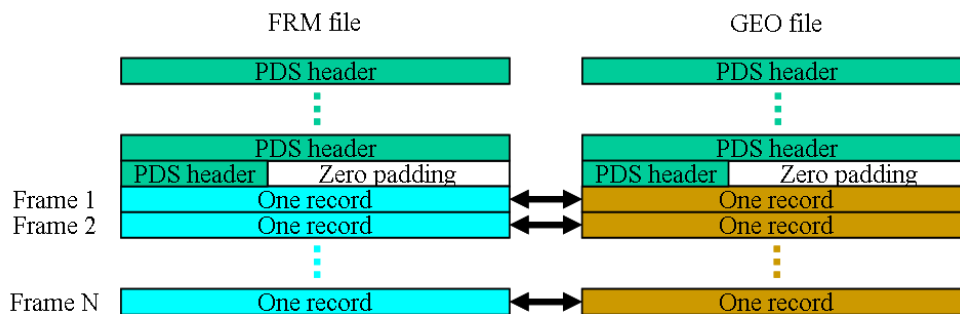

Figure 4.3.1 – 2 Relationship between an FRM file and the corresponding GEO file.

The second file constituting an EDR is called a Geometry file (GEO), and contains one record, corresponding to one line of the PDS binary TABLE object into which data are organised, for every frame in the corresponding FRM file (See Figure 4.3.1. -2). Columns of the table contains the values of parameters describing the geometry of observation for the corresponding frame. The parameters contained in a GEO table are listed in Appendix D.

4.3.2 SSx_YYY_IND_EDR DATA PRODUCT DESIGN

Subsurface data from Individual Echoes are the unprocessed version of data that are also down-linked in processed form, as explained in Section 2.3.7. A frame of Individual Echoes consists of a variable number of raw echoes, because, to produce a constant along-track ground resolution, synthetic aperture (Doppler) processing performed on board (see Section 2.3.3) requires a number of echoes that increases with altitude of the spacecraft.

Because of this, the data structure described in the previous section, storing processed frames as individual rows within a table, cannot be used. It has been thus chosen to produce one Data Product per each frame of Individual Echoes, rather than one per orbit. The Data Product consists in just one file containing a PDS header and the data themselves, because any additional geometric information would just duplicate similar information already provided in SSx_yyy_CMP_EDR GEO data files. File names contains the first ten digits of the spacecraft clock count corresponding to the time at which data were acquired.

Each record in a file contains a single unprocessed echo, preceded by auxiliary data and by a counter starting from 0 and increasing by one at each new echo. Echoes are ordered according to the time at which they were collected. Ancillary data for different instrument modes are listed and explained in Appendix B. Ancillary information is produced once per frame, and is thus the same for all echoes in a file: this duplication has been deemed necessary to simplify the data structure as much as possible.

The number of echoes required in Doppler processing is a function of frequency, as well as of spacecraft altitude. In a dual-frequency mode, the exact number of echoes collected at each frequency is contained in the Ancillary data (see Appendix B), and echoes within a frame are ordered by frequency before being ordered in time. An example of file structure for a dual-frequency Individual Echoes Data Product is shown in Figure 4.3.2 - 1.

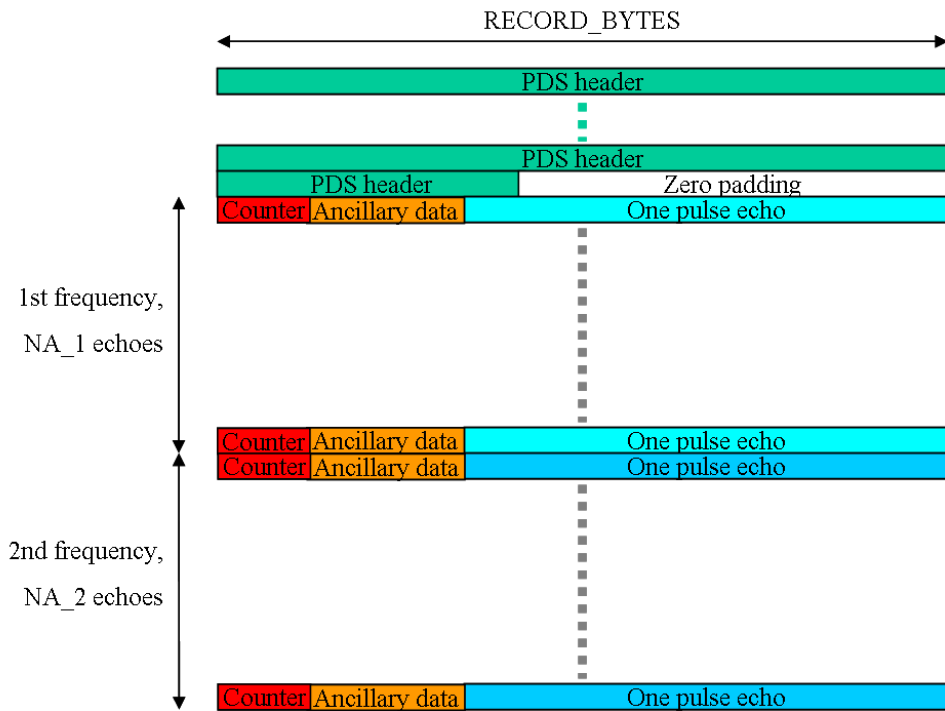

Figure 4.3.2 – 1 File structure for a SSx_yyy_IND_EDR Data Product in a dual-frequency mode. NA_1 is the number of echoes collected using the first band, while NA_2 is the corresponding number for the second band.

4.3.3 SSx_yyy UNC_EDR DATA PRODUCTS

Subsurface UNC data are the uncompressed version of data that are also down-linked in fully processed form, as explained in Sections 2.3.6 and 2.3.8. Because they are structured exactly as CMP data, the only difference being the compression of individual echo samples from 4-byte IEEE real numbers to 1-byte integers, it has been chosen to produce one Data Product per orbit, just as for CMP data. The Data Product consists in just one file containing a PDS header and the data themselves, because any additional geometric information would just duplicate similar information already provided in SSx_yyy_CMP_EDR GEO data files. File names contain the four-digit number of the orbit at which data were acquired

The structure of UNC Data Products is identical to the one used in CMP FRM files shown in Figure 4.3.1 – 1. Because UNC data are down-linked through a dump of the flash memory, rather than through the scientific telemetry of the instrument, they do not come with a full set of ancillary data.

4.3.4 SSx_yyy RAW_EDR DATA PRODUCT DESIGN

Subsurface Raw Data are the unprocessed version of data that are also down-linked in processed form, as explained in Section 2.3.8. A frame of Raw Data consists of a variable number of raw echoes, because, to produce a constant along-track ground resolution, synthetic aperture (Doppler) processing performed on board (see Section 2.3.3) requires a number of echoes that increases with altitude of the spacecraft.

Because of this, it has been chosen to produce one Data Product per each frame of Raw Data, rather than one per orbit, similarly to Individual Echoes. The Data Product consists in just one file containing a PDS header and the data themselves, because any additional geometric information would just duplicate similar information already provided in SSx_yyy_CMP_EDR GEO data files. File names contain the first ten digits of the spacecraft clock count corresponding to the time at which data were acquired.

The structure of RAW Data Products is identical to the one used in IND files shown in Figure 4.3.2 – 1. Because RAW data are down-linked through a dump of the flash memory, rather than through the scientific telemetry of the instrument, they do not come with a full set of ancillary data.



4.4 REDUCED DATA RECORD SUBSURFACE DATA SET: DEFINITION AND CONTENT

The MARS EXPRESS MARS MARSIS REDUCED DATA RECORD SUBSURFACE V1.0 Data Set contains subsurface-sounding data from the MARS EXPRESS MARS MARSIS EXPERIMENT DATA RECORD V1.0 Data Set that have been uncompressed (See Section 2.3.6), calibrated and, except for data acquired using the SS2 mode, range-processed (see Section 2.3.4) after correcting for the distortion of the transmitted signal caused by the ionosphere. It is important to note that echoes collected in the acquisition (ACQ) phase (see Section 2.3.9), having a much smaller bandwidth, cannot be processed to achieve a vertical resolution sufficient for scientific analysis, and aren't thus used in generating Reduced Data Records. Geometric information needed to locate observations in space and time is also provided in the Data Set.

Figure 4.4 - 1 shows the simulated echo of Figure 4.2 - 1 after correlation with the transmitted signal, i.e. after range processing. No ionosphere distortion of the signal or instrument noise effects were introduced in the simulations. Now, peaks corresponding to individual subsurface reflections are clearly visible. Echoes coming from layers that are too deep or too close to each other are not discernible. The “bumps” in the processed echo are an artefact of the range compression processing (“sidelobes”): they must not be confused with echoes from subsurface layers.

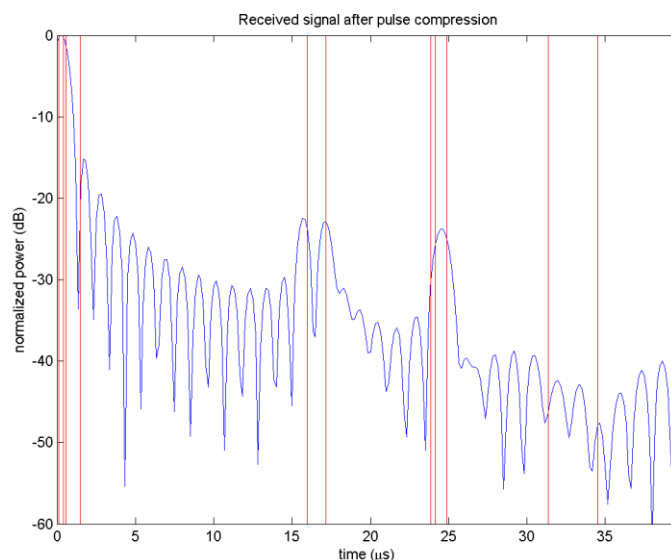

Figure 4.4 – 1 Plot of a received echo produced by means of a simple one-dimensional simulation of signal propagation through a plane parallel stratigraphy, after correlation with the transmitted signal. Red vertical bars mark instants of time in which echoes from each subsurface layer reach the radar.

This Data Set contains data produced by the instrument using all subsurface sounding modes described in Section 2.3.12. After ground processing, data referring to the same observation but multiply down-linked, following different types of on-board processing, produce a single processed observation. Although processed echoes have a different size and content with respect to unprocessed echoes, within a Data Product the structure of individual frames is not modified, and it is the one described for compressed (CMP) data in Sections 2.5 and 2.6 and in Appendix C.

Data Products need to accommodate the different data structures produced by different modes of the instrument. Thus, there is a single type of Data Product in this Data Set, which is specialized into five different subtypes, one for each subsurface sounding mode, following the same general structure detailed in the previous section.



Data Product Type	Description
SSx_RDR	Subsurface Sounding data that have been uncompressed, calibrated and range-processed, together with geometry information

Table 4.4 – 1 List of RDR-SS data Products. The “x” used in the Data Product Types column stands for a number between 1 and 5 (See Section 3.1.3 for explanations).

Data Product files are named according to the convention defined in Section 3.1.3. As it will be described in the following section, SSx_RDR Data Product files contain data acquired throughout a single orbit, and are thus identified by a four-digit orbit number. Furthermore, SSx_RDR Data Products possess geometric information that is written in a separate file, and thus each Data Product consists of a file containing instrument frames (FRM file) and one containing geometric information (GEO file).

4.5 REDUCED DATA RECORD SUBSURFACE DATA PRODUCT DESIGN

4.5.1 SSx_RDR DATA PRODUCT DESIGN

SSx_RDR Data Products are made by two files, each of which contains a PDS binary TABLE object preceded by a PDS attached label describing its structure. The first file, called Frame file (FRM) contains the instrument data proper, organised into individual frames having an identical structure as the one described for compressed (CMP) data in Sections 2.5 and 2.6 and in Appendixes B and C. Each frame corresponds to a record in the file, which is also a row in the PDS binary TABLE object into which frames are organised. A Data Product contains all frames acquired using the same instrument mode in tracking (TRK) state during a single orbit. The resulting structure is illustrated in Figure 4.3.1 - 1.

The second file constituting an EDR is called a Geometry file (GEO), and contains one record, corresponding to one line of the PDS binary TABLE object into which data are organised, for every frame in the corresponding FRM file (See Figure 4.3.1. - 2). Columns of the table contain the values of parameters describing the geometry of observation for the corresponding frame. The parameters contained in a GEO table are listed in Appendix D.



APPENDIXES

A EXAMPLE PDS LABEL FOR MARSIS DATA PRODUCT FILES

The following label is taken from the MARSIS data file FRM_SS3_TRK_CMP_EDR_1886.DAT, and illustrates the use of keywords described in Appendix E.

```
PDS_VERSION_ID          = PDS3
LABEL_REVISION_NOTE     = "2004-12-06 R. Orosei: draft;
                          2005-07-08 R. Orosei: revised;
                          2006-10-25 R. Orosei: revised."

RECORD_TYPE             = FIXED_LENGTH
RECORD_BYTES            = 006912
FILE_RECORDS            = 0965
FILE_NAME                = "FRM_SS3_TRK_CMP_EDR_1886.DAT"
LABEL_RECORDS           = 0002

^TABLE                  = 0003

DATA_SET_ID             = "MEX-M-MARSIS-2-EDR-V1.0"
DATA_SET_NAME           = "MARS EXPRESS MARS MARSIS EXPERIMENT
                          DATA RECORD V1.0"

PRODUCT_ID              = FRM_SS3_TRK_CMP_EDR_1886
PRODUCT_TYPE            = EDR
PRODUCT_CREATION_TIME   = 2007-07-19T08:30:27.356
RELEASE_ID              = 0001
REVISION_ID             = 0000
MISSION_NAME            = "MARS EXPRESS"
INSTRUMENT_HOST_ID     = MEX
INSTRUMENT_HOST_NAME   = "MARS EXPRESS"
INSTRUMENT_NAME        = "MARS ADVANCED RADAR FOR SUBSURFACE AND
                          IONOSPHERE SOUNDING"

INSTRUMENT_ID           = MARSIS
TARGET_NAME             = MARS
TARGET_TYPE             = PLANET
MISSION_PHASE_NAME     = "ME PHASE 2"
MISSION_ID              = MEX
START_TIME              = 2005-07-04T20:08:58.067
STOP_TIME               = 2005-07-04T20:34:53.758
SPACECRAFT_CLOCK_START_COUNT = "1/0068587732.55509"
SPACECRAFT_CLOCK_STOP_COUNT  = "1/0068589288.35273"
ORBIT_NUMBER            = 1886
PRODUCER_ID             = MARSIS_TEAM
PRODUCER_FULL_NAME     = "GIOVANNI PICARDI"
PRODUCER_INSTITUTION_NAME = "UNIVERSITY OF ROME LA SAPIENZA"
DATA_QUALITY_DESC       = "-1: percentage of corrupted data not available
                          0: no corrupted data
                          1: less than 2% corrupted data
                          2: less than 5% corrupted data
                          3: less than 10% corrupted data
                          4: more than 10% corrupted data"

DATA_QUALITY_ID         = 0
INSTRUMENT_MODE_DESC    = "In this mode, the instrument transmits two
                          frequency-modulated waveforms in close
                          succession, each having a 1 MHz bandwidth
                          but centered at a different frequency. The
                          signal is acquired through both the dipole
                          and the monopole antennas.
                          An altitude-dependent number of echoes
```



(of the order of hundred) is collected in a single batch. Doppler processing adds a delay to the samples of each echo, and then sums the samples so as to allow the constructive sum of the signal component coming from a desired direction. Each coherent sum of the echoes is called a synthesized filter: this mode produces 3 filters. Data are converted from four-byte real numbers to one-byte integer numbers by extracting and storing the exponent of the sample with the largest absolute value, and by normalizing the entire echo by that exponent. Passive ionosphere sounding is also performed, by opening the receiver and collecting the signal produced by the ionosphere plasma around the spacecraft."

```
INSTRUMENT_MODE_ID      = SS3_TRK_CMP
INSTRUMENT_TYPE        = RADAR
PROCESSING_LEVEL_ID    = 2
PROCESSING_LEVEL_DESC  = "Corrected for telemetry errors and split or
                          decommutated into a data set for a given
                          instrument. Sometimes called Experimental Data
                          Record. Data are also tagged with time and
                          location of acquisition.
                          Corresponds to NASA Level 0 data."

OBJECT                  = TABLE
INTERCHANGE_FORMAT     = BINARY
ROWS                   = 0963
ROW_BYTES              = 006912
^STRUCTURE             = "FRM_SS3_TRK_CMP_EDR.FMT"
COLUMNS               = 75
END_OBJECT             = TABLE

FOOTPRINT_POINT_LATITUDE = ((-18.26,-9.222,-0.641),
                           (-0.48,11.021,22.319),
                           (22.413,45.195,71.076),
                           (71.228,72.709,74.075))
FOOTPRINT_POINT_LONGITUDE = ((207.741,207.641,207.563),
                             (207.561,207.507,207.54),
                             (207.541,208.164,212.984),
                             (213.061,213.891,214.809))

END
```



B AUXILIARY DATA STRUCTURES

The following table contains structure for Calibration (CAL), Receive Only (RXO) and Active Ionospheric Sounding (AIS) modes. Practically all elements in this structure are similar except for 4 fields that have different names and one extra field that only contains data in the AIS mode.

Field name	Description	Size (bytes)	Type
First PRI of the Frame	First PRI of the Frame	4	unsigned int
SCET_FRAME	SCET time of the frame	6	unsigned int
SCET_PERICENTER	SCET time of the Pericenter pass	6	unsigned int
SCET_PAR	Number of seconds in SCET time to the pericenter passing. This is the basis for calculation of all parameters in the Orbit Determination block	6	signed int
H_SCET_PAR	Range to the surface at the pericenter.	4	signed int
VT_SCET_PAR	Tangential velocity of the spacecraft at the pericenter	4	float
VR_SCET_PAR	Radial velocity of the spacecraft at the pericenter	4	Float
No	No is an offset equal to 36 PRIs (TBC)	4	unsigned int
DS_MIN	The space to be covered by the spacecraft during NB pulses $\Delta S_{min} = 5500m$	4	Float
NB_MIN	PRIs shall be grouped in sets of NB each representing a "Frame". NB is computed adaptively during the flyby. $NB_{min} = 160$	2	unsigned int
ah0	Polynomial coefficients for onboard range to the surface determination (even coefficients)	4	Float
ah2		4	Float
ah4		4	Float
ah6		4	Float
ar1	Polynomial coefficients for onboard radial velocity determination. (even coefficients)	4	Float
ar3		4	Float
ar5		4	Float
ar7		4	Float
at0	Polynomial coefficients for onboard tangential velocity determination. (even coefficients)	4	Float
at2		4	Float
at4		4	Float
at6		4	Float
DS_SCET_PAR		4	Float
NB_160_dec		2	Unsigned int
AGC_CAL_PT_Value	Automated gain control PT Values (db). Note different names for CAL, RXO and AIS modes.	4	Float
AGC_RO_PT_Value			
AGC_AIS			
AGC_CAL_Level	Automated gain control levels. HW register, binary. Note different names for CAL, RXO and AIS modes.	1	unsigned byte
AGC_RO_Level			
AGC_AIS_Level			
RX_Trig_CAL_comp	Receive Trigger Compression? (ms) for CAL, RXO and AIS modes. Note different names for CAL, RXO and AIS modes.	2	unsigned int
RX_Trig_RO_comp			
RX_Trig_AIS			



RX_Trig_CAL_progr	Receive Trigger Program for CAL, RXO and AIS modes. HW register Note different names for CAL, RXO and AIS modes.	2	unsigned int
RX_Trig_RO_progr			
RX_Trig_AIS_progr			
AISMaxOutputData	Only applicable in AIS mode. AIS Maximum output data exponent	1	unsigned byte
Ah1	Polynomial coefficients for onboard range to the surface determination. (odd coefficients)	4	Float
Ah3		4	Float
Ah5		4	Float
Ah7		4	Float
ar0	Polynomial coefficients for onboard radial velocity determination. (odd coefficients)	4	Float
ar2		4	Float
ar4		4	float
ar6		4	float
at1	Polynomial coefficients for onboard tangential velocity determination. (odd coefficients)	4	float
at3		4	float
at5		4	float
at7		4	float
Spare	Not used here	72	
	Total	228	

Auxiliary data structure for all Calibration, Receive Only and Active Ionosphere Sounding modes.



Auxiliary Data for Acquisition Phase

Field name	Description	Size (bytes)	Type
First PRI of the Frame	First PRI of the Frame	4	unsigned int
SCET_FRAME	SCET time of the frame	6	unsigned int
SCET_PERICENTER	SCET time of the Pericenter pass	6	unsigned int
SCET_PAR	Number of seconds in SCET time to the pericenter passing. This is the basis for calculation of all parameters in the Orbit Determination block	6	signed int
H_SCET_PAR	Range to the surface at the pericenter.	4	signed int
VT_SCET_PAR	Tangential velocity of the spacecraft at the pericenter	4	float
VR_SCET_PAR	Radial velocity of the spacecraft at the pericenter	4	Float
No	No is an offset equal to 36 PRIs	4	unsigned int
DS_MIN	The space to be covered by the spacecraft during NB pulses $\Delta S_{min}=5500m$	4	Float
NB_MIN	PRIs shall be grouped in sets of NB each representing a "Frame". NB is computed adaptively during the flyby. NB_min = 160	2	unsigned int
ah0	Polynomial coefficients for onboard range to the surface determination (even coefficients)	4	Float
ah2		4	
ah4		4	
ah6		4	
ar1	Polynomial coefficients for onboard radial velocity determination. (even coefficients)	4	Float
ar3		4	
ar5		4	
ar7		4	
at0	Polynomial coefficients for onboard tangential velocity determination. (even coefficients)	4	Float
at2		4	
at4		4	
at6		4	
DS_SCET_PAR	MARSIS footprint size at the pericenter.	4	Float
NB	NB- number of frames taken in order to accommodate ΔS .	2	Unsigned int
AGC_PIS_PT_Value_B1	AGC PIS PT Value Band 1 and Band 2 (db)	4	Float
AGC_PIS_PT_Value_B2		4	Float
AGC_PIS_Levels_B1	AGC PIS Levels Band 1 and Band 2, HW register, binary	1	byte
AGC_PIS_Levels_B2		1	byte
K_PIM	Parameter used in the Passive Noise Measurement Processing, which cannot exceed the value of 5	1	byte

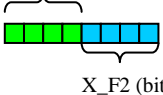

PIS Maximum output data exp [B1]	PIS Maximum output data exp [B1]/[B2]	1	byte
PIS Maximum output data exp [B2]		1	byte
AGC_NPM_PT_VALUE	Automatic Gain Control value used during the Noise Power Measurement Phase.	4	Float
AGC_NPM_Levels	Single Automatic Gain Control value used during the Noise Power Measurement Phase. There are two levels. The second one is used only after the Acquisition has failed for the first one.	1	byte
NPM_Int_F1	This parameter is evaluated during the Noise Power Measurement Phase (dB). For the Frequency F1 and F2	4	Float
NPM_Int_F2		4	
X_F1 / X_F2 (allowed values: 1, 2, 3, 4)	Treshold for Power Control for S0 dipole F1 and F2.MMMMMNNNN M-bits represent X_F1 N-bits represent X_F2	1	X_F1 (bits 7-4)  X_F2 (bits 3-0)
AGC_COLL_X_F1	Automatic Gain Control value used during echoes collection. There are four values for each frequency.	4	Float
AGC_COLL_X_F2		4	Float
AGC_COLL_X_Levels_F1	Single Automatic Gain Control value used during echoes collection (dB).	1	byte
AGC_COLL_X_Levels_F2		1	byte
RX_Trig_ACQ_comp	Starting position of the Receiving Window during the Acquisition Phase.	2	Unsigned int
RX_Trig_ACQ_progr	Parameter used during the evaluation of the receiving window position.	2	Unsigned int
AGC_SA_for_TRK_Frame_F1 (0 in case of LED failure)	Automatic Gain Control value evaluated during the Acquisition Phase and used by the first frame of the Tracking Phase (dB). For frequency F1 and F2.	4	Float
AGC_SA_for_TRK_Frame_F2 (0 in case of LED failure)		4	
RX_Trig_SA_for_TRK_Frame_F1 (0 in case of LED failure)	Receiving Window position evaluated during the Acquisition Phase and used by the first frame of the Tracking Phase. For frequency F1 and F2.	2	Unsigned int
RX_Trig_SA_for_TRK_Frame_F2 (0 in case of LED failure)		2	



DET_T HRESH_F1	Threshold used during the Noise Power Measurement Phase for the frequency F1 and F2	4	Float
Det_Thresh_F2		4	
K_Det_Thres_F1	Multiplicative factor used during the Noise Power Measurement Phase. For frequency F1 and F2.	4	Float
K_Det_Thres_F2		4	
K_Det_Thres_min_F1	Threshold used during the Noise Power Measurement Phase for the frequency F1 and F2	4	Float
K_Det_Thres_min_F2		4	
Φ _ACQ_F1 (Real)	Azimuth Compression (Doppler Filter) parameter value.	4	Float
Φ _ACQ_F1 (Immaginary)	Azimuth Compression (Doppler Filter) parameter value.	4	Float
Φ _ACQ_F2 (Real)	Azimuth Compression (Doppler Filter) parameter value.	4	Float
Φ _ACQ_F2 (Immaginary)	Azimuth Compression (Doppler Filter) parameter value.	4	Float
N_D (0 in case of LED failure)	Parameter used for the evaluation of the AGC_SA. It is stored in the PT	2	Unsigned int
K_AGC (0 in case of LED failure)	Parameter used for the evaluation of the AGC_SA. It is stored in the PT.	4	Float
Aref (0 in case of LED failure) -	Parameter used for the evaluation of the AGC_SA. It is stored in the PT.	4	Float
Ref_Fun_Flag_F1 (0 = default, 1 = corrected)	This parameter shows if, for the range compression, has been used the default reference function or the corrected reference function. For frequency F1 and F2.	1	Unsigned int
Ref_Fun_Flag_F2 (0 = default, 1 = corrected)		1	
i_le_F1 (-1 in case of LED failure)	Position of the first sample of the signal that exceed the Noise threshold (Leading Edge Detection algorithm). For frequency F1 and F2.	2	Signed int
i_le_F2 (-1 in case of LED failure)		2	
T_le_F1 (-Tc in case of LED failure)	Time of the first sample of the signal that exceed the Noise threshold (Leading Edge Detection algorithm). For frequency F1 and F2	4	Float
T_le_F2 (-Tc in case of LED failure)		4	



**MARS EXPRESS - MARSIS
TO PLANETARY SCIENCE ARCHIVE
INTERFACE CONTROL DOCUMENT**

Document No. INFOCOM TR 024.005.2003
Issue/Rev. No. 3.0
Date November 26, 2007

Maximum RE output data exponent [OP_F1]	Maximum data output exponent. Order : pairs of exponents for real and imaginary parts of the spectra for the Doppler filter, Frequency F1.	1	Unsigned int
Maximum IM output data exponent [OP_F1]		1	Unsigned int
Maximum RE output data exponent [OP_F2]	Maximum data output exponent. Order : pairs of exponents for real and imaginary parts of the spectra for the Doppler filter, Frequency F2	1	Unsigned int
Maximum IM output data exponent [OP_F2]		1	Unsigned int
NS_LED	Parameter used by the Leading Edge Detection algorithm.	2	Unsigned int
Processing_PRF	Value of the actual PRF used by the radar.	4	Float
Total		225	
Spare		3	



Auxiliary data structure for all subsurface modes.

Field name	Description	Size (bytes)	Type	Applicable modes
First PRI of the Frame	First PRI of the Frame	4	unsigned int	SS1,SS2,SS3,SS4,SS5
SCET_FRAME	SCET time of the frame	61	unsigned int - 6 bytes	SS1,SS2,SS3,SS4,SS5
SCET_PERICENTER	SCET time of the Pericenter pass	6	unsigned int - 6 bytes	SS1,SS2,SS3,SS4,SS5
SCET_PAR	Number of seconds in SCET time to the pericenter passing. This is the basis for calculation of all parameters in the Orbit Determination block	6	signed int - 4 bytes unsigned int - 2 bytes	SS1,SS2,SS3,SS4,SS5
H_SCET_PAR	Range to the surface at the pericenter.	4	signed int	SS1,SS2,SS3,SS4,SS5
VT_SCET_PAR	Tangential velocity of the spacecraft at the pericenter	4	float - 4bytes	SS1,SS2,SS3,SS4,SS5
VR_SCET_PAR	Radial velocity of the spacecraft at the pericenter	4	float	SS1,SS2,SS3,SS4,SS5
N0	No is an offset equal to 36 PRIs	4	unsigned int	SS1,SS2,SS3,SS4,SS5
DS_MIN	The space to be covered by the spacecraft during NB pulses $\Delta S_{min}=5500m$	4	float	SS1,SS2,SS3,SS4,SS5
NB_MIN	PRIs shall be grouped in sets of NB each representing a "Frame". NB is computed adaptively during the flyby. NB min = 160	2	unsigned int	SS1,SS2,SS3,SS4,SS5
M_OCOG_F1	Maximum of the signal power in the OCOG window for the frequency F1	4	float	SS1,SS2,SS3,SS4,SS5
M_OCOG_F2	Maximum of the signal power in the OCOG window for the frequency F2	4	float	SS1,SS2,SS3
Index_OCOG_F1	OCOG position value sampled (Range : 1 to 512) for frequency F1	2	unsigned int	SS1,SS2,SS3,SS4,SS5
Index_OCOG_F2	OCOG position value sampled (Range : 1 to 512) for frequency F2	2	unsigned int	SS1,SS2,SS3
TRK_Threshold_F1	Loss of Lock threshold, evaluated starting from the noise level. For frequency F1	4	float	SS1,SS2,SS3,SS4,SS5

¹ SCET times in Mars Express mission are encoded as 4 byte whole part and 2 byte fractional part. Both are unsigned integers. The only exception is SCET_PAR which has signed whole part and unsigned fractional part. In vanilla interface one has to query SCET times separately. For example to retrieve SCET_FRAME it is necessary to query SCET_FRAME_whole and SCET_FRAME_frac parameter. We hope that this will not necessary as vanilla also allows access ephemeris_time, which is more universal than SCET time.



TRK_Threshold_F2	Loss of Lock threshold, evaluated starting from the noise level. For frequency F2	4	float	SS1,SS2,SS3
ini_ind_TRK_Threshold_F1	First sample (Range : 1 to 512) of a sub-window, located in the receiving window, used to evaluate the noise level and then the TRK_Threshold_F1	2	unsigned int	SS1,SS2,SS3,SS4,SS5
ini_ind_TRK_Threshold_F2	First sample (Range : 1 to 512) of a sub-window, located in the receiving window, used to evaluate the noise level and then the TRK_Threshold_F2	2	unsigned int	SS1,SS2,SS3
Last_ind_TRK_Threshold_F1	Last sample (Range : 1 to 512) of a sub-window, located in the receiving window, used to evaluate the noise level and then the TRK_Threshold_F1	2	unsigned int	SS1,SS2,SS3,SS4,SS5
Last_ind_TRK_Threshold_F2	Last sample (Range : 1 to 512) of a sub-window, located in the receiving window, used to evaluate the noise level and then the TRK_Threshold_F2	2	unsigned int	SS1,SS2,SS3
ini_ind_FSRM_F1	Parameters for processing using FSR method (range : 1 to 512) for F1	2	unsigned int	SS1,SS2,SS3,SS4,SS5
ini_ind_FSRM_F2	Parameters for processing using FSR method (range : 1 to 512) for F2	2	unsigned int	SS1,SS2,SS3
Last_ind_FSRM_F1	Parameters for processing using FSR method (range : 1 to 512) for F1	2	unsigned int	SS1,SS2,SS3,SS4,SS5
Last_ind_FSRM_F2	Parameters for processing using FSR method (range : 1 to 512) for F1	2	unsigned int	SS1,SS2,SS3
Spare (0x0)	Not used here.	12	Byte	SS1,SS2,SS3,SS4,SS5
DS_SCET_PAR	MARSIS footprint size at the pericenter	4	float	SS1,SS2,SS3,SS4,SS5
NB_SCET_PAR	NB - number of frames taken in order to accommodate ΔS .	2	unsigned int	SS1,SS2,SS3,SS4,SS5
NA_1_SCET_PAR	NA is the actual number of pulses over which the aperture was acquired for frequency 1	2	unsigned int	SS1,SS2,SS3,SS4,SS5
NA_2_SCET_PAR	Same as NA1, but for the second frequency (mode dependent).	2	unsigned int	SS1,SS2,SS3,SS4,SS5
a2_ini_cm_F1	a ₂ starting value for the on board Contrast Method for the frequency F1	4	float	SS1,SS2,SS3,SS4,SS5
a2_ini_cm_F2	a ₂ starting value for the on board Contrast Method for the frequency F2	4	float	SS1,SS2,SS3
a2_opt_F1	a ₂ optimum value evaluated by the on board Contrast Method for the frequency F1	4	float	SS1,SS2,SS3,SS4,SS5



a2_opt_F2	a ₂ optimum value evaluated by the on board Contrast Method for the frequency F2	4	float	SS1,SS2,SS3
Ref_CA_opt_F1	Optimum value of the integrated modulus of the signal, evaluated by the on board Contrast Method to estimate the a _{2_opt_F1}	4	float	SS1,SS2,SS3,SS4,SS5
Ref_CA_opt_F2	Optimum value of the integrated modulus of the signal, evaluated by the on board Contrast Method to estimate the a _{2_opt_F2}	4	float	SS1,SS2,SS3
dt_F1	Signal peak position (Range: 1...512) evaluated by the on board FSR Method for F1. ($\delta t_{F1} = 0$ in case of FSRM failure)	2	unsigned int	SS1,SS2,SS3,SS4,SS5
dt_F2	Signal peak position (Range: 1...512) evaluated by the on board FSR Method for F2. ($\delta t_{F2} = 0$ in case of FSRM failure)	2	unsigned int	SS1,SS2,SS3
Sf_F1	Peak value of the signal square modulus evaluated by the on board FSR Method for F1. (Sf_F1= 0 in case of FSRM failure)	4	float	SS1,SS2,SS3,SS4,SS5
Sf_F2	Peak value of the signal square modulus evaluated by the on board FSR Method for F1. (Sf_F1= 0 in case of FSRM failure)	4	float	SS1,SS2,SS3
I_c_F1	Sample (range : 1 to 512) where the signal square modulus exceeds the threshold in the FSR Method (I_c_F1 - 1 in case of threshold comparison failure)	2	unsigned int	SS1,SS2,SS3,SS4,SS5
I_c_F2	Sample (range : 1 to 512) where the signal square modulus exceeds the threshold in the FSR Method (I_c_F2 - 1 in case of threshold comparison failure)	2	unsigned int	SS1,SS2,SS3
AGC_SA_for_Next_Frame_F1	AGC = Automated Gain Control Setting for Next Frame (db)	4	float	SS1,SS2,SS3,SS4,SS5
AGC_SA_for_Next_Frame_F2	AGC = Automated Gain Control Setting for Next Frame (db)	4	float	SS1,SS2,SS3
AGC_SA_Levels_Current_Frame_F1	AGC SA Levels Current Frame F1. This value is reported in samples.	1	Byte	SS1,SS2,SS3,SS4,SS5
AGC_SA_Levels_Current_Frame_F2	AGC SA Levels Current Frame F2. This value is	1	Byte	SS1,SS2,SS3



	reported in samples.			
RX_Trig_SA_for_Next_Frame_F1	RX window position for the current frame F1 – (μ s)	2	unsigned int	SS1,SS2,SS3,SS4,SS5
RX_Trig_SA_for_Next_Frame_F2	RX window position for the current frame F2 – (μ s)	2	unsigned int	SS1,SS2,SS3
RX_Trig_SA_progr_F1	RX windows position for the current frame F1	2	unsigned int	SS1,SS2,SS3,SS4,SS5
RX_Trig_SA_progr_F2	RX windows position for the current frame F2	2	unsigned int	SS1,SS2,SS3
ini_ind_OCOG	Initial index for OCOG (range 1 to 512)	2	unsigned int	SS1,SS2,SS3,SS4,SS5
Last_ind_OCOG	last index for OCOG (range 1 to 512)	2	unsigned int	SS1,SS2,SS3,SS4,SS5
OCOG_F1	OCOG position value for F1	4	float	SS1,SS2,SS3,SS4,SS5
OCOG_F2	OCOG position value for F2	4	float	SS1,SS2,SS3
A_F1	Signal energy for the AGC tracker error evaluation for frequency F1	4	float	SS1,SS2,SS3,SS4,SS5
A_F2	Signal energy for the AGC tracker error evaluation for frequency F2	4	float	SS1,SS2,SS3
C_LoL_F1	Loss of Lock – frequency F1. Tracking status: if ≥ 0 no tracking if < 0 tracking	2	unsigned int	SS1,SS2,SS3,SS4,SS5
C_LoL_F2	Loss of Lock – frequency F2. Tracking status: if ≥ 0 no tracking if < 0 tracking	2	unsigned int	SS1,SS2,SS3
SS2_DCEX_1	Internal Radar parameter	2	unsigned int	SS2
SS2_DCEX_2	Internal Radar parameter	2	unsigned int	SS2
SS2_DCEX_3	Internal Radar parameter	2	unsigned int	SS2
MaxCmpOut	Maximum data output exponent. Order : pairs of exponents for real and imaginary parts of the spectra for Doppler filter, Frequency, Antenna. So an array of values would look like this MaxOutExp(Re/Im, Ndoppler,Nfreq,Nant), where Re/Im is 1/2, Ndoppler is 1 to 5, Nfreq is 1 or 2, Nant is 1 for dipole, 2 for monopole). See note on order of doppler filters in this array. In SS4 mode only one band is used.	20	unsigned byte	SS1,SS3,SS4,SS5
AGC_PIS_PT_Value_B1	AGC PIS PT Value Band 1 (db)	4	float	SS1,SS2,SS3,SS4,SS5
AGC_PIS_PT_Value_B2	AGC PIS PT Value Band 2 (db)	4	float	SS1,SS2,SS3,SS4,SS5
AGC_PIS_Levels_B1	AGC PIS Levels Band 1, HW register, binary	1	byte	SS1,SS2,SS3,SS4,SS5



**MARS EXPRESS - MARSIS
TO PLANETARY SCIENCE ARCHIVE
INTERFACE CONTROL DOCUMENT**

Document No. INFOCOM TR 024.005.2003
Issue/Rev. No. 3.0
Date November 26, 2007

AGC_PIS_Levels_B2	AGC PIS Levels Band 2, HW register, binary	1	byte	SS1,SS2,SS3,SS4,SS5
K_PIM	Parameter used in the Passive Noise Measurement Processing, which cannot exceed the value of 5	1	byte	SS1,SS2,SS3,SS4,SS5
PISMaXOutDataExp_B1	PIS Maximum output data exp [B1]	1	byte	SS1,SS2,SS3,SS4,SS5
PISMaXOutDataExp_B2	PIS Maximum output data exp [B2]	1	byte	SS1,SS2,SS3,SS4,SS5
Processing_PRF	Processing PRF (pulse repetition frequency)	4	float	SS1,SS2,SS3,SS4,SS5
Spare (0x0)	Not used here.	1	byte	SS1,SS2,SS3,SS4,SS5
Total bytes :		228		



C SCIENTIFIC DATA STRUCTURE

The following table summarizes the information contained in Sections 2.5 and 2.6.

Mode	State	Form	Antennas	Bands or Tones	Filters	Echoes	Arrays per filter or echo	Samples per	BYTES PER SAMPLE	PIS bytes	Total bytes per frame
CAL	N/A	N/A	2	1	N/A	80	1	1960	1	0	313600
RXO	N/A	N/A	2	1	N/A	80	1	1960	1	0	313600
AIS	N/A	N/A	1	160	N/A	1	1	80	2	0	25600
SS1	ACQ	CMP	1	2	1	N/A	2	1024	1	512	4608
SS1	TRK	CMP	2	2	1	N/A	2	512	1	512	4608
SS2	ACQ	CMP	1	2	1	N/A	2	1024	1	512	4608
SS2	TRK	CMP	1	2	1	N/A	1	512	2	512	2560
SS3	ACQ	CMP	1	2	1	N/A	2	1024	1	512	4608
SS3	TRK	CMP	1	2	3	N/A	2	512	1	512	6656
SS4	ACQ	CMP	1	1	1	N/A	2	1024	1	512	2560
SS4	TRK	CMP	2	1	5	N/A	2	512	1	512	10752
SS5	ACQ	CMP	1	1	1	N/A	2	1024	1	512	2560
SS5	TRK	CMP	2	1	3	N/A	2	512	1	512	6656
SS1	ACQ	UNC	1	2	1	N/A	2	1024	4	512	16896
SS1	TRK	UNC	2	2	1	N/A	2	512	4	512	16896
SS2	ACQ	UNC	1	2	1	N/A	2	1024	4	512	16896
SS2	TRK	UNC	1	2	1	N/A	1	512	4	512	4608
SS3	ACQ	UNC	1	2	1	N/A	2	1024	4	512	16896
SS3	TRK	UNC	1	2	3	N/A	2	512	4	512	25088
SS4	ACQ	UNC	1	1	1	N/A	2	1024	4	512	8704
SS4	TRK	UNC	2	1	5	N/A	2	512	4	512	41472
SS5	ACQ	UNC	1	1	1	N/A	2	1024	4	512	8704
SS5	TRK	UNC	2	1	3	N/A	2	512	4	512	25088
SS1	ACQ TRK	RAW	2	2	N/A	Variable	1	980	1	0	Variable
SS2	ACQ TRK	RAW	1	2	N/A	Variable	1	980	1	0	Variable
SS3	ACQ TRK	RAW	1	2	N/A	Variable	1	980	1	0	Variable
SS4	ACQ TRK	RAW	2	1	N/A	Variable	1	980	1	0	Variable
SS5	ACQ TRK	RAW	2	1	N/A	Variable	1	980	1	0	Variable
SS1	ACQ TRK	IND	2	2	N/A	128 Max.	1	980	1	0	501760 Max.
SS2	ACQ TRK	IND	1	2	N/A	256 Max.	1	980	1	0	501760 Max.
SS3	ACQ TRK	IND	1	2	N/A	256 Max.	1	980	1	0	501760 Max.
SS4	ACQ TRK	IND	2	1	N/A	256 Max.	1	980	1	0	501760 Max.
SS5	ACQ TRK	IND	2	1	N/A	4 × 64 Max.	1	980	1	0	501760 Max.

Formats and sizes of frames, according to instrument mode and state, and data form, as derived from [AD04].



D KEYWORD LISTING FOR GEO FILES

The following table lists the parameters contained in a GEO (geometry auxiliary information) file accompanying instrument data files. The listed keywords are column names in the Table Object contained in the GEO file.

Parameter Name	Data Type	Bytes	Units	Description
SCET_GEO_WHOLE	MSB_INTEGER	4	-	Spacecraft clock count at the beginning of the frame, coarse part
SCET_GEO_FRAC	MSB_INTEGER	2	-	Spacecraft clock count at the beginning of the frame, fine part
EPHEMERIS_TIME	IEEE_REAL	8	<s>	Seconds elapsed since Jan, 1, 2000, 12:00 UTC corresponding to SCET_FRAME
GEOMETRY_EPOCH	CHARA CTER	23	-	Time, corresponding to SCET_FRAME, at which the geometrical and position parameters are computed, expressed in UTC
MARS_SOLAR_LONGITUDE	IEEE_REAL	4	<DEGREES>	Angle between the Mars-Sun line at the time of interest and the Mars-Sun line at the vernal equinox
MARS_SUN_DISTANCE	IEEE_REAL	4	<km>	Distance from the centre of Mars to centre of the Sun
ORBIT_NUMBER	IEEE_REAL	4	-	Number of the current orbital revolution of the Mars Express spacecraft around Mars.
TARGET_NAME	CHARACTER	6		Name of the celestial body being observed by MARSIS at the time corresponding to SCET_GEO.
TARGET_SC_POSITION_VECTOR		24		Position vector of the Mars Express spacecraft in the reference frame of the target body at the time corresponding to SCET_GEO, expressed in Km (along x, y, z axes)
SPACECRAFT_ALTITUDE	IEEE_REAL	4	<km>	Distance from the spacecraft to the reference surface of Mars measured normal to the surface
SUB_SC_EAST_LONGITUDE	IEEE_REAL	8	<km/s>	East longitude of the point on the target body that lies directly beneath the Mars Express spacecraft at the time corresponding to SCET_GEO, expressed in degrees and in the [0 -360] range frame.
SUB_SC_PLANETOCENTRIC_LATITUDE	IEEE_REAL	4	<km/s>	Planetocentric latitude of the point on the target body that lies directly beneath the Mars Express spacecraft at the time corresponding to SCET_GEO, expressed in degrees



TARGET_SC_VELOCITY_VECTOR	IEEE_REAL	24	<Km/s>	MEX velocity relative to body(Vx ,Vy ,Vz component)
TARGET_SC_RADIAL_VELOCITY	IEEE_REAL	8	<Km/s>	The radial component of the Mars Express spacecraft velocity vector in the reference frame of the target body at the time corresponding to SCET_GEO
TARGET_SC_TANG_VELOCITY		8		Tangential component of the Mars Express spacecraft velocity vector in the reference frame of the target body at the time corresponding to SCET_GEO
LOCAL_TRUE_SOLAR_TIME	IEEE_REAL	8	<DEGREES>	Angle between the extension of the vector from the Sun to Mars and the projection on Mars' ecliptic plane of a vector from the center of the target body and the point on the target body surface that lies directly beneath the Mars Express spacecraft at the time corresponding to SCET_GEO, expressed on a 24-hour clock with decimal fractions of the hour.
SOLAR_ZENITH_ANGLE	IEEE_REAL	8	<DEGREES>	Angle between the zenith and the apparent position of the Sun measured at the point on the target body surface that lies directly beneath the Mars Express spacecraft at the time corresponding to SCET_GEO, expressed in degrees
DIPOLE_UNIT_VECTOR	IEEE_REAL	24	<Km/s>	Unit vector directed along MARSIS dipole Antenna in the reference frame of the target body at the time corresponding to SCET_GEO
MONOPOLE_UNIT_VECTOR	IEEE_REAL	24	<km/s>	Unit vector directed along MARSIS monopole Antenna in the reference frame of the target body at the time corresponding to SCET_GEO

Keyword list and value formats for GEO files.



E KEYWORD LISTING FOR PDS LABELS

Different PDS keywords are used in labels of different PDS file labels. The following table lists which keywords are used in which file type label.

Keyword Name	EDR-FRM	EDR-GEO	EDR-LOG	RDR-SS-FRM	RDR-SS-GEO	RDR-SS-LOG	INDEX	CATALOG	CALIB	[Other]
Label Standards Identifier										
PDS_VERSION_ID	X	X	X	X	X	X	X	X	X	X
LABEL_REVISION_NOTE	X	X	X	X	X	X		X		
File Characteristic Data Elements										
RECORD_TYPE	X	X	X	X	X	X	X	X	X	X
RECORD_BYTES	X	X	X	X	X	X	X		X	
FILE_RECORDS	X	X	X	X	X	X	X		X	
FILE_NAME	X	X	X	X	X	X				
LABEL_RECORDS	X	X	X	X	X	X				
Data Object Pointer										
^TABLE	X	X	X	X	X	X				
Data Identification Elements										
DATA_SET_ID	X	X	X	X	X	X				
DATA_SET_NAME	X	X	X	X	X	X				
PRODUCT_ID	X	X	X	X	X	X				
RELEASE_ID	X	X	X	X	X	X				
REVISION_ID	X	X	X	X	X	X				
PRODUCT_TYPE	X	X	X	X	X	X				
PRODUCT_CREATION_TIME	X	X	X	X	X	X				
MISSION_ID	X	X	X	X	X	X				
MISSION_NAME	X	X	X	X	X	X				
INSTRUMENT_HOST_ID	X	X	X	X	X	X				
INSTRUMENT_HOST_NAME	X	X	X	X	X	X				
INSTRUMENT_ID	X	X	X	X	X	X				
INSTRUMENT_NAME	X	X	X	X	X	X				
TARGET_NAME	X	X	X	X	X	X				
TARGET_TYPE	X	X	X	X	X	X				
MISSION_PHASE_NAME	X	X	X	X	X	X				
MISSION_ID	X	X	X	X	X	X				
START_TIME	X	X	X	X	X	X				
STOP_TIME	X	X	X	X	X	X				
SPACECRAFT_CLOCK_START_COUNT	X	X	X	X	X	X				
SPACECRAFT_CLOCK_STOP_COUNT	X	X	X	X	X	X				
ORBIT_NUMBER	X	X	X	X	X	X				
PRODUCER_ID	X	X	X	X	X	X				
PRODUCER_FULL_NAME	X	X	X	X	X	X				
INSTITUTION_NAME	X	X	X	X	X	X				
Descriptive Data Elements										
INSTRUMENT_MODE_ID	X	X		X	X					
INSTRUMENT_MODE_DESC	X	X		X	X					



DATA_QUALITY_ID	X	X	X	X	X	X				
DATA_QUALITY_DESC	X	X	X	X	X	X				
PROCESSING_LEVEL_ID	X	X	X	X	X	X				
PROCESSING_LEVEL_DESC	X	X	X	X	X	X				
<i>Data Object Definition</i>										
ROWS	X	X	X	X	X	X				
ROW_BYTES	X	X	X	X	X	X				
^STRUCTURE	X	X	X	X	X	X				
COLUMNS	X	X	X	X	X	X				
FOOTPRINT_POINT_LATITUDE	X	X	X	X	X	X				
FOOTPRINT_POINT_LONGITUDE	X	X	X	X	X	X				

Keywords used in different file types within the MARSIS data archive.



In the following table, a description and valid values for the PDS keywords used in file labels is provided.

Keyword name	Definition	Type	Valid values
COLUMNS	Number of columns in each row of a data object.	Integer	Variable
DATA_QUALITY_DESC	This element describes the data quality which is associated with a particular DATA_QUALITY_ID value. The various values of DATA_QUALITY_ID and DATA_QUALITY_DESC are instrument dependent.	String	"-1: percentage of corrupted data not available 0: no corrupted data 1: less than 2% corrupted data 2: less than 5% corrupted data 3: less than 10% corrupted data 4: more than 10% corrupted data"
DATA_QUALITY_ID	This element provides a numeric key which identifies the quality of data available for a particular time period.	String (3)	"-1","0","1","2","3","4"
DATA_SET_ID	This element is a unique alphanumeric identifier for a data set or a data product. In most cases it is an abbreviation of the DATA_SET_NAME.	String (40)	"MEX-M-MARSIS-2-EDR-V1.0", "MEX-M-MARSIS-3-RDR-SS-V1.0", "MEX-M-MARSIS-2-EDR-EXT1-V1.0", "MEX-M-MARSIS-3-RDR-SS-EXT1-V1.0" See also Section 3.1.1 for details.
DATA_SET_NAME	This element provides the full name given to a data set. It typically identifies the instrument that acquired the data, the target of that instrument, and the processing level of the data.	String (60)	"MARS EXPRESS MARS MARSIS EXPERIMENT DATA RECORD V1.0", "MARS EXPRESS MARS MARSIS REDUCED DATA RECORD SUBSURFACE V1.0", "MARS EXPRESS MARSIS EDR DATA EXTENSION_1 V1.0", "MARS EXPRESS MARSIS RDR SUBSURFACE DATA EXTENSION_1 V1.0" See also Section 3.1.1 for details.
FILE_NAME	This element provides the location independent name of a file.	String (120)	The name of the file itself "FRM_SS3_TRK_IND_EDR_1886.DAT"
FILE_RECORDS	This element indicates the number of physical file records, including both label records and data records.	Integer	Equal to the total file length divided by RECORD_BYTES
FOOTPRINT_POINT_LATITUDE	This data element provides an array of values that represent the latitudes of points along the edge of an image footprint on the planet's surface. Latitude values are planetocentric.	Real	Variable
FOOTPRINT_POINT_LONGITUDE	This data element provides an array of values that represent the longitudes of points along the edge of an image footprint on the planet's surface. Longitude values are planetocentric.	Real	Variable



INSTRUMENT_HOST_ID	This element provides a unique identifier for the host where an instrument is located.	String (11)	MEX
INSTRUMENT_HOST_NAME	This element provides the full name of the host on which an instrument is based.	String (120)	"MARS EXPRESS"
INSTRUMENT_ID	This element provides an abbreviated name or acronym which identifies an instrument.	String (12)	MARSIS
INSTRUMENT_MODE_DESC	This element describes the instrument mode which is identified by the INSTRUMENT_MODE_ID element.	String	See Appendix A for an example.
INSTRUMENT_MODE_ID	This element provides an instrument-dependent designation of operating mode. This may be simply a number, letter or code, or a word such as 'normal', 'full resolution', 'near encounter', or 'fixed grating'.	String (20)	"AIS", "CAL", "RXO" "SS1_ACQ", "SS1_TRK", "SS2_ACQ", "SS2_TRK", "SS3_ACQ", "SS3_TRK", "SS4_ACQ", "SS4_TRK", "SS5_ACQ", "SS5_TRK"
INSTRUMENT_NAME	This element provides the full name of an instrument.	String (60)	"MARS ADVANCED RADAR FOR SUBSURFACE AND IONOSPHERE SOUNDING"
INSTRUMENT_TYPE	This element identifies the type of an instrument.	String (30)	RADAR
INTERCHANGE_FORMAT	Manner in which data items are stored.	String (6)	BINARY
LABEL_RECORDS	This element indicates the number of physical file records that contain only label information.	Integer	The number of data records in a file is determined by subtracting the value of LABEL_RECORDS from the value of FILE_RECORDS.
LABEL_REVISION_NOTE	This element is a free-form unlimited length character string providing information regarding the revision status and authorship of a PDS label. This should include the latest revision date and author of the current version, but may include a more complete history.	String (75)	"2003-11-20, Roberto Orosei (INAF), initial release; 2004-05-07, updated."
MISSION_ID	This element provides a synonym or mnemonic for the MISSION_NAME element.	String	MEX
MISSION_NAME	This element identifies a major planetary mission or project. A given planetary mission may be associated with one or more spacecraft.	String (60)	"MARS EXPRESS"



MISSION_PHASE_NAME	This element provides the commonly-used identifier of a mission phase.	String (30)	“PRIMARY MISSION” “EXTENDED MISSION”
ORBIT_NUMBER	This element identifies the number of the orbital revolution of the spacecraft around a target body.	Integer	Any value used by the Mars Express project
PDS_VERSION_ID	This data element represents the version number of the PDS standards documents that is valid when a data product label is created.	String (6)	PDS3
PROCESSING_LEVEL_DESC	This data element provides the CODMAC standard definition corresponding to a particular PROCESSING_LEVEL_ID value.	String (75)	For a fuller definition of CODMAC processing levels, please refer to the PDS Standards Reference [AD10].
PROCESSING_LEVEL_ID	This data element identifies the processing level of a set of data according to the eight-level CODMAC standard.	String (1)	2, 3
PRODUCER_FULL_NAME	This element provides the full name of the individual mainly responsible for the production of a data set.	String (60)	“GIOVANNI PICARDI”
PRODUCER_ID	This element provides a short name or acronym for the producer or producing team/group of a dataset.	String (20)	MARSIS_TEAM
PRODUCER_INSTITUTION_NAME	This element identifies a university, research centre, NASA centre or other institution associated with the production of a data set.	String (60)	“UNIVERSITY OF ROME LA SAPIENZA”
PRODUCT_CREATION_TIME	This element defines the UTC system format time when a product was created.	Time	Formation rule is YYYY-MM-DDThh:mm:ss.fff
PRODUCT_ID	This data element represents a permanent, unique identifier assigned to a data product by its producer.	String (40)	For FRM and GEO files of any MARSIS data set, PRODUCT_ID is the file name without extension For LOG files of any MARSIS data set, PRODUCT_ID is the file name without extension.
PRODUCT_TYPE	This data element identifies the type or category of a data product within a data set.	String (40)	EDR RDR
RECORD_BYTES	This element indicates the number of bytes in a physical file record, including record terminators and separators.	Integer	When RECORD_BYTES describes a file with RECORD_TYPE = STREAM (e.g. a SPREADSHEET), its value is set to the length of the longest record in the file.
RECORD_TYPE	This element indicates the record format of a file.	String (20)	FIXED_LENGTH STREAM



RELEASE_ID	This element defines the unique identifier associated with a specific release of a data set. All initial releases should use a RELEASE_ID value of '0001'. Subsequent releases should use a value that represents the next increment over the previous RELEASE_ID (e.g., the second release should use a RELEASE_ID of '0002'). Releases are done when an existing data set or portion of a data set becomes available for distribution.	String (4)	From "0001" to "9999"
REVISION_ID	This element is a unique identifier associated with a specific revision of a data set release. A data set revision contains the initial data of a data set release or it might comprise supplementary files, that shall be appended to the data set release, or updated files, that shall replace existing files in the data set release, or files existing in the release that shall be deleted from the data set release.	String (4)	From "0000" to "9999"
ROWS	Number of rows in a data object.	Integer	Number of Data Blocks in the Data Product
ROW_BYTES	Number of bytes in each data object row.	Integer	Variable
SPACECRAFT_CLOCK_START_COUNT	This element provides the value of the spacecraft clock at the beginning of an observation.	String (30)	Formation rule is p/ccccccccc.ffff where p is the partition number, c stands for SCET_COARSE, and f for SCET_FINE
SPACECRAFT_CLOCK_STOP_COUNT	This element provides the value of the spacecraft clock at the end of an observation.	String (30)	Formation rule is p/ccccccccc.ffff where p is the partition number c stands for SCET_COARSE, and f for SCET_FINE
START_TIME	This element provides the date and time of the beginning of an observation in UTC system format.	Time	Formation rule is YYYY-MM-DDThh:mm:ss.fff
STOP_TIME	This element provides the date and time of the end of an observation in UTC system format.	Time	Formation rule is YYYY-MM-DDThh:mm:ss.fff
TARGET_NAME	This element identifies a target.	String (30)	MARS
TARGET_TYPE	This element identifies the type of a named target.	String (20)	PLANET, SATELLITE



^INDEX_TABLE ^SPREADSHEET ^TABLE	Data objects are the actual data for which the structure and attributes are defined in a PDS label. Each data product file contains one data object. The PDS uses a pointer within the product labels to identify the file location for the object in a data product.	String	In an attached label, the value is an integer number denoting the first record of the data object within the file: the first n-1 records are part of the attached label, and thus n should be equal to LABEL_RECORDS + 1. In a detached label, the value is the name of the file containing the data product, enclosed in quotes
^STRUCTURE	This element identifies the name of a file located in the LABEL directory and containing the definition of the data object structure.	String	The value is the name of the file located in the LABEL directory containing the definition of the data object structure, enclosed in quotes. Such file is called just like the corresponding data file without the orbit number, and with the extension changed to .FMT

Meaning and valid values for keywords used in different file types within the MARSIS data archive.