



## OBDH SW ICD

	NAME	FUNCTION	SIGNATURE	DATE
<b>Prepared by:</b>	C.Pasqui	EI.Eng. (G.A.)		
<b>Approved by:</b>	M. Giustini	PAPM (G.A.)		
	M. Cosi	Sys. Eng.(G.A.)		
<b>Authorized by:</b>	E. Suetta	PM (G.A)		

<b>Approved by:</b>	G. Piccioni	PI		
	P. Drossart	PI		
	A. Semery	DESPA		
	G. Peter	DLR		

## DOCUMENT CHANGE RECORD

Issue	Date	Total Pages	Pages Affected	Description of Modification
1	10/07/2003	191	All	Creation of the document for Venus Express. Starting from the document: <b>VIRTIS OBDH SW ICD,</b> <b>Ref: VIR-GAL-IC-0048, issue 7, dated 20/03/03,</b> and adjusting it to Venus Express. The change bars of this issue show the changes implemented for Venus Express.
2	9/12/03	191	156, 157, 162, 164, 166, 167  179,183  110,158  57,110,158  166  156  186  180	<b>(Modifica gestita secondo PQC0502 para.5.3.6)</b>  Change default and valid values for M_IR_DELAY, M_CCD_DELAY and M_CCD_EXPO in the TCs MTC_Cange_Func_Param and MTC_Cange_Cal_Param  Corrected error in the valid range of H integration times  Added value=2 in the parameter M_SU also for EM  Changed valid range and default value for M_SHUTT_CURR  Corrected offset value for M_IR_L_CURR  Changed default value to M_IR_VDETCOM  Changed the default values of the H pixel map parameters Add note for definition of the relevant Dead Pixel Map file (New input derived from VVX-LES-TR-2078 is1.0)  Changed default values coefficients for H_V_Bias; H_I_Lamp_Spect_T; H_I_Lamp_Spect_S; H_I_Lamp_Radio; H_I_Shutter. (New input derived from VVX-LES-TR-2078 is1.0 and VVX-LES-TR-2045 is1.0)  (all modifications are marked by revision side bar)

Issue	Date	Total Pages	Pages Affected	Description of Modification
3	26/02/04			<p><b>(Modifica gestita secondo PQC0502 para.5.3.6)</b></p> <p>Modified format of event 47910</p> <p>Changed the calibration curve of the telemetries after the –H and –M channels calibration. (New input derived from VVX-LES-TR-2078 is1.0 ,VVX-LES-TR-2045 is1.0)</p> <p>Added operational limits values in telemetry packets.</p> <p>Changed default value for angle first and angle last in MTC_Change_Func_Param</p> <p>Changed default values for *_expo in MTC_Cange_Cal_Param</p> <p><b>(all modifications are marked by revision side bar)</b></p>
4	12/07/04	196	51, 53, 54, 55, 56, 58, 59, 62, 64, 65, 66, 67, 115, 164, 165, 173, 175, 177, 186, 187,	<p><b>(Modifica gestita secondo PQC0502 para.5.3.6)</b></p> <p>Revised/finalized the operational limits after the instrument qualification</p> <p>Updated following the NCRs VVX-GAF-NC-012, 014, 018, 020, 024, 025, 029,</p> <p><b>(all modifications are marked by revision side bar)</b></p>
5	06/09/2004	196	(pag. 65) (pag. 191)	<p><b>(Modifica gestita secondo PQC0502 para.5.3.6)</b></p> <p>Updated following the NCRs</p> <p>VVX-VIR-NV-036 (VVX-LES-NC-007): changed calibration curve for HKMs_Det_Temp, changed pixel map coefficients and associated Dead Pixel Map file</p> <p><b>(all modifications are marked by revision side bar)</b></p>

## SCOPE

This document contains all the SW related information about the interface between the VIRTIS experiment and the VENUS EXPRESS Spacecraft as required in **RD- 1**. Functional interface requirements and data formats are described for either DMS/RTU channel as well High Speed link.

VIRTIS is a 3 data channel spectrometer included as payload in the VENUS EXPRESS mission. Science data from each channel are formatted in separate science TM packets transmitted normally on the HS link while other TM packets (e.g. H/K, event) are always transmitted to the RTU.

The electrical requirements of the interface are defined for all VENUS EXPRESS instruments in **RD- 1** while the derived requirements for VIRTIS implementation are given in **RD- 2**. In the same way, the functional requirements of the interface are defined for all VENUS EXPRESS instruments in **RD- 1** while this document specifies VIRTIS derived definitions.

The document is prepared by Galileo Avionica together with the other teams involved in the project, i.e. Science teams, LESIA, DLR. The document is checked and authorized by representatives of all the involved teams. It is responsibility of every team program managers to propagate relevant information in order to keep this document consistent and up to date.

## Table of CONTENTS

1	SOFTWARE CONCEPT AND FUNCTIONAL REQUIREMENTS .....	10
1.1	Software Overview .....	10
1.2	Autonomy Concept .....	11
1.3	Software Maintenance Approach .....	12
1.4	Data Delivery Concept (Application Process Ids) .....	12
1.5	Timing Requirements .....	14
1.6	TM packets time stamping .....	15
2	INSTRUMENT OPERATING MODES .....	16
2.1	Operative Mode definition .....	16
2.2	Mode transition Diagrams .....	30
3	PACKET DEFINITIONS .....	37
3.1	Packet Service Compliance .....	37
3.1.1	Telemetry Service Compliance .....	40
3.1.1.1	Telemetry Concept .....	40
3.1.1.2	TM Packet Header .....	40
3.1.1.3	TM Packet Data Field .....	41
3.1.1.4	TM Collection .....	42
3.1.2	Telecommand Service Compliance .....	43
3.1.2.1	Telecommand Concept .....	43
3.1.2.2	TC Packet Header .....	44
3.1.2.3	TC Packet Data Field .....	44
3.1.2.4	TC Distribution Protocol .....	45
3.2	Instrument Packet Definitions .....	46
3.2.1	Telemetry Packet Definitions .....	46
3.2.1.1	Telecommand Verification Reporting TM .....	46
3.2.1.2	H/K Data Reporting TMs .....	50
3.2.1.3	Event Reporting TMs .....	68
3.2.1.4	Test TMs .....	127
3.2.1.5	Science Data Transfer TMs - HS link .....	128
3.2.1.6	Science Data Header .....	131
3.2.1.7	Science Data Transfer TMs - RTU link .....	135
3.2.1.8	Memory Management TMs .....	137
3.2.2	Telecommand Packet Definitions .....	139
3.2.2.1	Service 1 - Housekeeping Reporting .....	139
3.2.2.2	Service 6 - Memory Management .....	141
3.2.2.3	Service 9 - Time Management .....	145
3.2.2.4	Service 17 - Connection Test .....	145
3.2.2.5	Service 20 - Science Reporting .....	146
3.2.2.6	Service 192 - VIRTIS Common Private TCs .....	148
3.2.2.7	Service 193 - VIRTIS-M Common Private TCs .....	155
3.2.2.8	Service 194 - VIRTIS-H Common Private TCs .....	177
3.2.2.9	Service 255 - Common Payload Private TCs .....	194
4	DMS RESOURCE REQUIREMENTS .....	196
4.1	SSMM Utilization .....	196
4.2	On-Board Control Procedures .....	196
4.3	On-board Monitoring Requirements .....	196
4.4	Information Distribution Requirements .....	196
4.5	DMS TM Packetisation Requirements .....	196

## ACRONYMS AND ABBREVIATIONS

AID	Acquisition IDentifier
APID	Application Process IDentifier
BIT	Built In Test
CCD	Charged Coupled Device
DD	Detected Data
DHSU	Data Handling and Support Unit
DMS	Data Management System
DPT	Data Production Type
ECA	Emergency Cover Actuator
EGSE	Electrical Ground Support Equipment
EID	Event ID
ERT	External Repetition Time
H/K	HouseKeepings
HS	High Speed
HW	HardWare
ICD	Interface Control Document
ID	IDentifier
I/F	InterFace
IR	InfraRed
IRT	Internal Repetition Time
LS	Low Speed
NSID	Number of SID
ME	Main Electronics
MLC	Memory Load Command
M/LSB	Most/Least Significant Bit
M/LSN	Most/Least Significant Nibble
M/LSW	Most/Least Significant Word
N.A.	Not Applicable
OBCP	On Board Control Procedure
OBDH	On Board Data Handling

PID	Process ID
PFC	Parameter Format Code
PTC	Parameter Type Code
RAM	Random Access Memory
RD	Reference Document
RTU	Remote Terminal Unit
S/C	SpaceCraft
SDT	Science Data Transfer
SID	Structure IDentification
SCET	SpaceCraft Elapsed Time
SDH	Science Data Header
SS	Slice Summing
SSMM	Solid State Mass Memory
SU	Scan Unit
SW	SoftWare
TBC	To Be Confirmed
TBD	To Be Defined
TBW	To Be Written
TC	TeleCommand
TM	TeleMetry
VIRTIS	Visible and InfraRed Thermal Imaging Spectrometer
VIS	VISible
VVX	Virtis for Venus

**REFERENCE DOCUMENTS**

- RD- 1 PID-A MEX-MMT-SP-0007 Issue : 02 Rev. : 0001 Payload Interface Document
- RD- 2 RO-EST-RS-30015/EID B sect. 2.7
- RD- 3 VIRTIS Requirements Document, VIR-GAL-RS-001
- RD- 4 VIRTIS Functional Architecture Specification, VIR-GAL-RS-045
- RD- 5 VIRTIS SW User Requirements, VVX-GAF-UR-001, issue 2,
- RD- 6 VIRTIS SW Internal ICD, VIR-GAL-IC-028, Issue 8
- RD- 7 VIRTIS ME On-Board SW User Manual , VVX-DLR-MA-001, issue 3 rev.1
- RD- 8 VIRTIS FM Calibration Data Record, VVX-GAF-RP-010, Issue:1
- RD- 9 VEX.T.ASTR.CR.0008 Issue 04 rev 1 Updated list of VIRTIS applicable documents
- RD- 10 VVX-LES-TR-2078 Issue 1.0 VIRTIS-VEX VIRTIS-H OPTICAL HEAD Optical Interface Calibration Report
- RD- 11 VVX-Les-TR-2045 Issue 1.0 VIRTIS-VEX PEM-H Calibration Data Record

## LIST OF TABLES

TAB. 1: VIRTIS APPLICATION PROCESS IDS .....	14
TAB. 2: VIRTIS MODE ID .....	16
TAB. 3 VIRTIS OPERATIVE MODES.....	21
TAB. 4: ME OPERATIVE MODES.....	23
TAB. 5 V-M OPERATIVE MODES (PART 1).....	24
TAB. 5: V-M OPERATIVE MODES (PART 2).....	25
TAB. 6: V-H OPERATIVE MODES (PART 1) .....	27
TAB. 6: V-H OPERATIVE MODES (PART 2) .....	28
TAB. 7: PACKET DEFINITIONS.....	39
TAB. 8: H/K REPORT SID AND GENERATION DEFINITION.....	50
TAB. 9: LIST OF EVENT REPORT EIDS .....	105
TAB. 10: SCIENCE TM PIDS.....	128
TAB. 11: MEMORY_IDS USAGE .....	141

## LIST OF FIGURES

FIG. 1: VIRTIS - S/C INTERFACE .....	10
FIG. 2: VIRTIS MODE AND STATE TRANSITIONS .....	30
FIG. 3: V-M MODE TRANSITIONS .....	33
FIG. 4: V-H MODE TRANSITIONS.....	35
FIG. 5: H SCIENCE DATA TMS .....	129
FIG. 6: M SCIENCE DATA TMS.....	130

## LIST OF TELEMETRY PACKETS

TM- 1: (PID51, PC1, T1, ST1) ACCEPTANCE SUCCESS REPORT .....	47
TM- 2: (PID51, PC1, T1, ST7) EXECUTION SUCCESS REPORT .....	47
TM- 3: (PID51, PC1, T1, ST2) ACCEPTANCE FAILURE REPORT .....	48
TM- 4: (PID51, PC1, T1, ST8) EXECUTION FAILURE REPORT .....	49
TM- 5: (PID51, PC4, T3, ST25, SID1) ME DEFAULT H/K .....	51
TM- 6: (PID51, PC4, T3, ST25, SID2) ME/M GENERAL H/K.....	53
TM- 7: (PID51, PC4, T3, ST25, SID3) ME/H GENERAL H/K.....	54
TM- 8: (PID51, PC4, T3, ST25, SID4) M-VIS H/K .....	55
TM- 9: (PID51, PC4, T3, ST25, SID5) M-IR H/K.....	58
TM- 10: (PID51, PC4, T3, ST25, SID6) H H/K.....	62
TM- 11: (PID51, PC7, T5, ST1, EID47501...48000) NORMAL_PROGRESS_EVENT_REPORT .....	69
TM- 12: (PID51, PC7, T5, ST2, EID47501...48000) ANOMALY_WARNING_EVENT_REPORT .....	70
TM- 13: (PID51, PC7, T5, ST3, EID47501...48000) GROUND_ACTION_EVENT_REPORT.....	71
TM- 14: (PID51, PC7, T5, ST4, EID47501...48000) ONBOARD_ACTION_EVENT_REPORT .....	72
TM- 15: (PID51, PC7, T5, ST1, EID47501) SECONDARY_BOOT_COMPLETED.....	106
TM- 16: (PID51, PC7, T5, ST1, EID47502) EVENT_EEPROM_STAT .....	108
TM- 17: (PID51, PC7, T5, ST1, EID47701) EVENT_M_DUMP_DATA_PRODUCTION_PARAMETER.....	112
TM- 18: (PID51, PC7, T5, ST1, EID47702) EVENT_M_DUMP_FUNCTIONAL_PARAMETER.....	113
TM- 19: (PID51, PC7, T5, ST1, EID47703) EVENT_M_DUMP_OPERATIONAL_PARAMETER .....	116
TM- 20: (PID51, PC7, T5, ST1, EID47704) EVENT_M_DUMP_ALTERNATE_PARAMETER.....	117
TM- 21: (PID51, PC7, T5, ST1, EID47705) EVENT_M_DUMP_CALIBRATION_PARAMETER.....	118
TM- 22: (PID51, PC7, T5, ST1, EID47901) H_DUMP_DATA_PRODUCTION_PARAMETER .....	121
TM- 23: (PID51, PC7, T5, ST1, EID47902) H_DUMP_FUNCTIONAL_PARAMETER .....	122
TM- 24: (PID51, PC7, T5, ST1, EID47903) H_DUMP_OPERATIONAL_PARAMETER.....	124
TM- 25: (PID51, PC7, T5, ST1, EID47906) H_DUMP_PIXEL_MAP_PARAMETER .....	125
TM- 26: (PID51, PC7, T5, ST1, EID47903) EVENT_H_PIX_MAP_CHECK_SUCCESS.....	126
TM- 27: (PID51, PC7, T17, ST2): CONNECTION TEST REPORT.....	127
TM- 28: (PID52, PC12, T20, ST13): M SCIENCE DATA (HS LINK) .....	133
TM- 29: (PID53, PC12, T20, ST13): H SCIENCE DATA (HS LINK).....	134
TM- 30: (PID52, PC12, T20, ST3): M SCIENCE DATA (RTU LINK).....	135
TM- 31: (PID53, PC12, T20, ST3): H SCIENCE DATA (RTU LINK) .....	136
TM- 32: (PID51, PC9, T6, ST6): MEMORY DUMP REPORT .....	137
TM- 33: (PID51, PC7, T6, ST10): MEMORY CHECK REPORT .....	138



**LIST OF TELECOMMAND PACKETS**

TC- 1: (PID51, PC12, T3, ST5) ENABLE_HK_REPORT_GENERATION .....	139
TC- 2: (PID51, PC12, T3, ST6) DISABLE_HK_REPORT_GENERATION .....	140
TC- 3: (PID51, PC12, T6, ST2) LOAD_MEMORY.....	142
TC- 4: (PID51, PC12, T6, ST5) DUMP_MEMORY .....	143
TC- 5: (PID51, PC12, T6, ST9) CHECK_MEMORY .....	144
TC- 6: (PID51, PC12, T9, ST1) ACCEPT_TIME_UPDATE.....	145
TC- 7: (PID51, PC12, T17, ST1) CONNECTION_TEST_REQUEST .....	145
TC- 8: (PID51, PC12, T20, ST1) ENABLE_SCIENCE_RTU_LINK.....	146
TC- 9: (PID51, PC12, T20, ST2) DISABLE_SCIENCE_RTU_LINK.....	147
TC- 10: (PID51, PC12, T20, ST10) ENABLE_SCIENCE_HS_LINK .....	147
TC- 11: (PID51, PC12, T20, ST11) DISABLE_SCIENCE_HS_LINK .....	148
TC- 12: (PID51, PC12, T192, ST1) VTC_ENTER_SAFE_MODE .....	148
TC- 13: (PID51, PC12, T192, ST2) VTC_ENTER_IDLE_MODE .....	149
TC- 14: (PID51, PC12, T192, ST3) VTC_ENTER_TEST_MODE .....	150
TC- 15: (PID51, PC12, T192, ST4) VTC_PEMS .....	151
TC- 16: (PID51, PC12, T192, ST5) VTC_COOLERS.....	152
TC- 17: (PID51, PC12, T192, ST10) VTC_OVERRIDE.....	153
TC- 18: (PID51, PC12, T192, ST11) VTC_DEOVERRIDE.....	153
TC- 19: (PID51, PC12, T192, ST12) VTC_CONFIRM.....	154
TC- 20: (PID51, PC12, T192, ST13) VTC_GET_EEPROM_STATUS .....	154
TC- 21: (PID51, PC12, T193, ST1) MTC_PEM .....	155
TC- 22: (PID51, PC12, T193, ST2) MTC_PEM_COMMAND_WORD.....	156
TC- 23: (PID51, PC12, T193, ST3) MTC_COVER .....	156
TC- 24: (PID51, PC12, T193, ST4) MTC_ECA.....	157
TC- 25: (PID51, PC12, T193, ST5) MTC_COOLER.....	158
TC- 26: (PID51, PC12, T193, ST6) MTC_ANNEALING .....	159
TC- 27: (PID51, PC12, T193, ST10) MTC_DEFAULT_CONFIGURATION.....	159
TC- 28: (PID51, PC12, T193, ST11) MTC_CHANGE_DATA_PRODUCT_PARAM_RAM.....	160
TC- 29: (PID51, PC12, T193, ST12) MTC_CHANGE_DATA_PRODUCT_PARAM_RAM_EEPROM .....	160
TC- 30: (PID51, PC12, T193, ST13) MTC_CHANGE_FUNC_PARAM_RAM .....	161
TC- 31: (PID51, PC12, T193, ST14) MTC_CHANGE_FUNC_PARAM_RAM_EEPROM.....	165
TC- 32: (PID51, PC12, T193, ST15) MTC_CHANGE_OPER_PARAM_RAM .....	166
TC- 33: (PID51, PC12, T193, ST16) MTC_CHANGE_OPER_PARAM_RAM_EEPROM .....	168
TC- 34: (PID51, PC12, T193, ST17) MTC_CHANGE_CAL_PARAM_RAM .....	169
TC- 35: (PID51, PC12, T193, ST18) MTC_CHANGE_CAL_PARAM_RAM_EEPROM.....	174
TC- 36: (PID51, PC12, T193, ST19) MTC_CHANGE_ALTERN_PARAM_RAM .....	175
TC- 37: (PID51, PC12, T193, ST20) MTC_CHANGE_ALTERN_PARAM_RAM_EEPROM .....	176
TC- 38: (PID51, PC12, T194, ST1) HTC_PEM.....	177
TC- 39: (PID51, PC12, T194, ST2) HTC_PEM_COMMAND_WORD.....	178
TC- 40: (PID51, PC12, T194, ST3) HTC_COVER.....	179
TC- 41: (PID51, PC12, T194, ST4) HTC_ECA .....	179
TC- 42: (PID51, PC12, T194, ST5) HTC_COOLER .....	180
TC- 43: (PID51, PC12, T194, ST6) HTC_ANNEALING .....	181
TC- 44: (PID51, PC12, T194, ST10) HTC_DEFAULT_CONFIGURATION .....	181
TC- 45: (PID51, PC12, T194, ST11) HTC_CHANGE_DATA_PRODUCT_PARAM_RAM .....	182
TC- 46: (PID51, PC12, T194, ST12) HTC_CHANGE_DATA_PRODUCT_PARAM_RAM_EEPROM.....	183
TC- 47: (PID51, PC12, T194, ST13) HTC_CHANGE_FUNC_PARAM_RAM.....	184
TC- 48: (PID51, PC12, T194, ST14) HTC_CHANGE_FUNC_PARAM_RAM_EEPROM.....	187
TC- 49: (PID51, PC12, T194, ST15) HTC_CHANGE_OPER_PARAM_RAM.....	188
TC- 50: (PID51, PC12, T194, ST16) HTC_CHANGE_OPER_PARAM_RAM_EEPROM.....	190
TC- 51: (PID51, PC12, T194, ST21) HTC_CHANGE_PIXEL_MAP_PARAM_RAM.....	191
TC- 52: (PID51, PC12, T194, ST21) HTC_CHANGE_PIXEL_MAP_PARAM_RAM_EEPROM.....	192
TC- 53: (PID51, PC12, T194, ST26) HTC_LOAD_PIXEL_MAP .....	193
TC- 54: (PID51, PC12, T194, ST27) HTC_CHECK_PIXEL_MAP.....	193
TC- 55: (PID51, PC12, T255, ST1) RESET_TELEMETRY_OUTPUT_BUFFER.....	194
TC- 56: (PID51, PC12, T255, ST2) RESET_SMCS_CHIP.....	194
TC- 57: (PID51, PC12, T255, ST3) START_HS_LINK.....	195
TC- 58: (PID51, PC12, T255, ST4) RESET_AND_START_HS_LINK.....	195

## 1 Software Concept and Functional Requirements

### 1.1 Software Overview

This section contains all the SW related information about the interface between the VIRTIS experiment and the VENUS EXPRESS Spacecraft, as required in RD- 1. Interface functional aspects and data formats are described for either DMS/RTU channel as well High Speed link (see Fig. 1).

As VIRTIS is a 3 data channel imaging spectrometer, science data from each channel are formatted in separate science TM packets transmitted on the HS link while other TM packets (e.g. H/K, event) are transmitted to the RTU.

The electrical requirements of the interface are defined for all VENUS EXPRESS instruments in RD- 1 while the derived VIRTIS implementation is described in RD- 2. In the same way, the functional requirements of the interface are defined for all VENUS EXPRESS instruments in RD- 1 while this section specifies VIRTIS derived definitions.

Unless explicitly specified, all telemetry and telecommand data between VIRTIS and OBDH described in the current document is aligned on 16-bit words, with the following bit numbering convention:

For Low speed link:

- Bit 0 = MSB = first transmitted bit;
- Bit 15 = LSB = last transmitted bit.

For High speed link:

On the 1355 HS link the byte order of the 16 bit word shall be most significant Byte (MSByte) first, least significant byte (LSByte) last while each byte will be transmitted "little endian" (i.e. least significant bit LSB first, most significant bit MSB last).

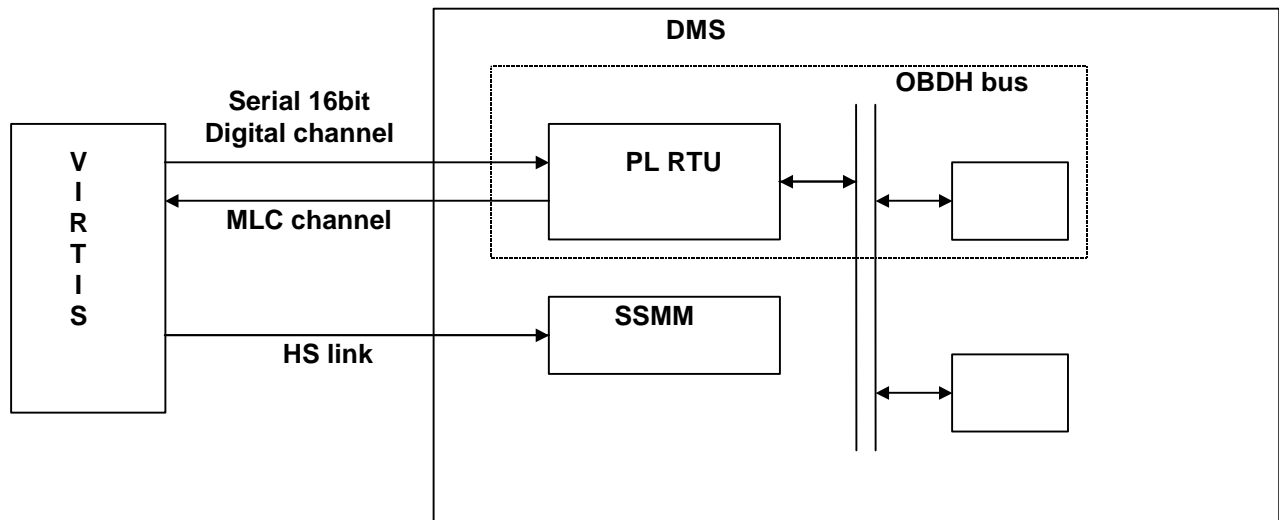

Fig. 1: VIRTIS - S/C Interface

## 1.2 Autonomy Concept

The VIRTIS software will detect Anomalous Events, related to malfunctions, and will perform recovery, safing and reporting actions. The VTC\_Override TC can inhibit the recovery/safing actions.

Anomalous Events will be classified as:

- Category 0: internal category, no error handling needed (no event is issued);
- Category I/1: events which do not prevent to continue with operations (anomaly warning type 2 is issued);
- Category I/2: events which do not prevent to continue with operations, event packet is issued only once when the event first time occurs (anomaly warning type 2 is issued);
- Category II: events for which it is possible to attempt to recover by a "Retry" procedure (i.e. retry to send to the HW the command which was not properly executed) (anomaly warning type 2 is issued);
- Category III: events for which it is possible to attempt to recover by a "Reset" procedure (i.e. reset the HW which shows the malfunction) (anomaly warning type 2 is issued);
- Category IV-H: events which prevent to continue with PEM-H operations but allows to continue with PEM-M operations (anomaly warning type 2 is issued);
- Category IV-M: events which prevent to continue with PEM-M operations but allows to continue with PEM-H operations (anomaly warning type 2 is issued);
- Category V/1: events which do not allow to continue with operations and for which an OBDH action is required (typically, switch to redundant/degraded mode), SW performs board reset (on-board action type 4 is issued);
- Category V/2: events which do not allow to continue with operations and for which an OBDH action is required (typically, switch to redundant mode), SW performs board reset after 30 sec of delay (on-board action type 4 is issued);
- Category V/2\*: events which do not allow to continue with operations and for which an OBDH action is required (typically, switch to redundant mode), SW performs board reset without delay (no event is issued);
- Category V/3: events which do not allow to continue with operations and for which an OBDH action is required (typically, switch to redundant/upload code), SW performs board reset after 30 sec of delay (on-board action type 4 is issued);
- Category VI: events which do not allow to continue with operations and for which Ground action is required, SW performs board reset (ground action type 3 is issued);
- Category VII: internal category, TC receive error
- Category VIII: internal category, TC verify error
- Category IX: normal progress event report (normal progress type 1 is issued);
- Category X: internal category, TC execution failure

### 1.3 Software Maintenance Approach

VIRTIS software is divided into two independent parts:

- The primary boot software, which is resident in PROM;
- The secondary boot software, which is resident in EEPROM.

The secondary boot software is in charge to manage the experiment, while the primary boot software is mainly in charge of supporting the software maintenance.

After VIRTIS startup, the primary boot software is loaded in RAM (Program Memory) by BBC hardware and executed; this software supports:

- Execution of the Memory Management Service TCs (Load\_Memory, Dump\_Memory, Check\_Memory);
- Execution of the secondary boot, loading the code from EEPROM to RAM (Program Memory), by the VTC\_Enter\_Idle\_Mode private TC.

Except for the PROM, all VIRTIS memories (EEPROM, Program Memory, Data Memory, PM Port, DM Port) can be uploaded by the Load\_Memory TC.

This means that it is possible to upload the software in EEPROM, if needed; moreover, in case e.g. the EEPROM fails, it is possible to load the Program Memory content and start execution directly from it.

The software is physically divided into segments, and each segment can be uploaded separately; this allows patching the software by uploading only one segment and not the whole software.

The segment approach also allows managing the case in which one or more of the 8 EEPROM chips fail, while the other ones are still working, by uploading the segments in the failed chips into other ones (assuming of course that enough free EEPROM is available).

### 1.4 Data Delivery Concept (Application Process Ids)

VIRTIS will produce the following types of TM data:

- TC verification reports;
- H/K data reports;
- Event reports;
- Memory reports;
- Science reports.

They are transmitted to the S/C DMS through the RTU I/F except the Science reports that are transmitted on the High Speed I/F. If this is not available (e.g. failure) the instrument can be commanded to start a degraded Science mode, which does not use the HS link. In this case the Science reports are transferred via the RTU I/F like the other TMs.

Data delivery is performed according to RD1. As explained below, packets are internally collected in TM blocks that are put in a H/W FIFO and transferred to the DMS when requested by it.

VIRTIS TM packets are generated via SDT (operational and science TM) or HS link interface (only science TM):

- After request by TC (e.g. TC verification Service Report, or TC Test Report)
- If an asynchronous event occurs (e.g. on-board action event report)
- Periodically e.g. for HK acquisition/generation
- Continuously if a science data generation/transfer is enabled in degraded mode (if the HS link cannot be used)

Transferring the **SDT TM packets** to the S/C is performed:

- If the ME internal TM collection buffer is full (6144 words block size is achieved) **or**
- If the ME internal TM packet collection interval of 16 seconds is over **or**
- If TC acceptances TM report is generated and max. after 4 seconds of TC receipt/acceptance
- If a TM\_Connection\_Test\_Report is generated max. 16 sec. after TC\_Connection\_Test\_Request
- If the S/C polls and acquires the TM data

All generated TM packets are buffered in a software FIFO buffer with a size of 6144 16bit words and in a hardware FIFO buffer with a size of 4096 16bit words. This allows avoiding TM data loss between the S/C polling interval (gap). The S/C polls the SDT interface once every 1 second (min) to 16 second (max). Polling the SDT interface means, the S/C gets a 16bit word from the SDT interface after a period of time (i.e. Polling Sequence Table, PST). If the content of the word is equal "0x0000", there are no TM data available in the TM hardware FIFO buffer and the S/C collects no additional TM data. If the content of the word is greater than "0x0000", it represents the number of words to be acquired as TM block. A TM block can contain one or more than one TM packets and its max. size is 6144 words. A TM packet size can be 8 ... 2056words, which corresponds to a TM packet length of 9...4105 octets.

Note: if a SDT interface polling is not active, the internal buffer overflows after a while. The software detects an error (FIFO overflow) but it is not possible to send an event TM report to the S/C. In this case the software resets the DPU that means VIRTIS goes in Safe mode.

Transferring the **HS link TM packets** to the S/C is performed after TC\_Enable\_Science\_HS\_Link. The TM packet size is 14words ... 512words (incl. TM header and Science header fields). 512words is the nominal TM packet size. Smaller TM packets are sent only in case that the "rest" of a sub-slice (data packet for -M or -H) or of a spectrum (data packet only for -H) are transferred.

#### H/K packets

They contain data required both for monitoring the operational aspects of the instrument and for interpreting science data. H/K parameters are self standing (i.e. not require data from other packets or TC history to be interpreted) and have the same structure and interpretation in all TM packets in which they appear. H/K reports are generated in a "periodic mode".

There are 6 H/K packet types identified by means of their Structure Identification (SID) included in the packet and used on ground together with APID, Service Type and Sub-Type, to identify the report and its content. The packet types are:

- ME default H/K;
- ME/M general H/K;
- ME/H general H/K;
- V-H H/K;
- V-M-VIS H/K;
- V-M-IR H/K.

#### Event packets

Event reports represent an higher level of information than H/K reports, therefore they are the preferred method to perform monitoring activities. They report to ground or DMS unambiguous operational information such as:

- Failures and/or anomalies detected on-board;
- Autonomous on-board actions;
- Normal progress of payload operation/activities.

Event packets:

- Include an unique identifier of the event, its occurrence time and related data;
- Are generated only once per event occurrence and are concise;

- Includes the nature/severity of the event;
- Are self standing (i.e. not require data from other packets or TC history to be interpreted);

Each event report type has its Event Identifier (like H/K reports have their SID) derived from a selected list controlled by the project. Event reports have fixed structure per EID.

Process ID	Packet Category	Packet Type	Usage
51	12	TC	For ALL telecommand packets to VIRTIS
51	1	TM	Telecommand acknowledge packets
51	4	TM	Housekeeping data reporting from VIRTIS ( note that there will be 6 SIDs within this App Id)
51	7	TM	Event reporting from VIRTIS ( note that there will be N TBD EIDs within this App Id)
51	7	TM	Test reporting from VIRTIS
51	9	TM	Memory download from VIRTIS
52	12	TM	Science data from unit VIRTIS M-VIS and VIRTIS M-IR(1)
53	12	TM	Science data from unit VIRTIS H (1)

TAB. 1: VIRTIS Application Process Ids

#### NOTES TO TAB. 1:

(1) Two Process Id are requested for VIRTIS science data as independent on-board and ground processing is necessary for the two independent data streams from the units V-M and V-H.

## 1.5 Timing Requirements

Time references in TCs, TMs and on-board procedures are in SCET, i.e. the time the DMS will maintain and distribute on the OBDH bus. This time value is transmitted to the experiment as 6 octets, (32 bit unit seconds, 16 bit fractional seconds, see RD1, 2.8.1.8) and has a resolution of 15,3 $\mu$ s (1/65536 sec) while the experiment time-stamps its TM packets with a time reference whose MS bit is usually set to 0 unless for any reason synchronization is missing (e.g. no time update from the S/C) or lost (e.g. payload failure). Note that the distributed SCET has ALWAYS the MS bit =0.

To perform a correct synchronization of the user internal timer to the SCET, the user complies with the Timer Synchronization Protocol defined in 2.7.3.3. and 2.8.1.8. and 2.8.1.9 of RD1, specifically using both TSY (period 8 sec) and HFC lines as follows:

- The user is able to receive the first Time Update TC Packet with a delay from power-on of min. 20 sec and max. 60 sec (RD1, Sec. 2.8.1.9); if no time update is received within 60 sec, the user starts anyway sending its TM using a non-synchronized value i.e. with the MS bit set to 1;
- The frequency of Time Update is in the order of several hours ( $\approx$ 1);
- The Packet is decoded in a short time less than the margin of 0.5 sec that will be included by DMS for the experiment to process this type of packet before the following TSY is received;
- With the next rising (first) edge of TSY pulse an interrupt is generated and the received time value is written into the 48 bit internal timer (in the OBDH FPGA on DPU extension). The HFC clocks this FPGA timer (as well all other H/W timers);
- The internal timer is used to time stamp VIRTIS TM Packets (e.g. for Science data time stamp, the timer is read out in the interrupt routine which transfers the science data out from the -M or -H IFE FIFO and the value is written in the related Science data TM packets);
- If for any reason (e.g. instrument failure) the synchronization is lost, the user time-stamps its TM with a non-synchronized value (i.e. MS bit =1).

The update will be performed in all operative modes when the TSY is received, by overwriting the VIRTIS internal timer with the SCET. Additionally, if the difference between these timers is found greater than 20 ms, a warning event is issued (see 2.8.3.2.1, Event Reporting TMs).



The loss of accuracy due to the possible time drift is anyway very small (e.g. 0,1 msec if the time update were performed once in 1000 days) and the VIRTIS-ME time stamp accuracy for Science TM would result still better than 20 ms as described in what follows (all values are worst case estimations):

- S/C HFC drift: 0,1 ms (1000 days \* 0,1  $\mu$ s/day, see RD1);
- S/C TSY jitter: 2 $\mu$ s (see RD1);
- TSY interrupt acceptance time (incl. C call int. dispatcher, 112 Instr.): 5,6  $\mu$ s;
- TSY interrupt routine run time until the timer is started: 1  $\mu$ s;
- -M/-H data receipt interrupt acceptance time: 56  $\mu$ s (Science mode) (10 Interrupts at the same time x 8,1 $\mu$ s (162instr.)/interrupt);
- -M/-H data receipt interrupt routine (first FIFO interrupt, during one of the Science mode) run time until the timer is read: 4 ms (as the 3 channels can issue an interrupt at the same time, the worst case is when two channels have to be read out before the 3d. channel data are read out i.e. 10Instr x 50ns/Instr x 4000bytes (half FIFO) x 2channels = 4,1672 ms (+ 100% margin).

## 1.6 TM packets time stamping

Each TM packet sent to the S/C is time stamped using the internal ME SCET timer.

ME internally reads the time from the 48bit timer if the event occurs (i.e. it is not read if the TM packet is put in the TM buffer or sent to the S/C) in order to achieve a high correlation between the event for TM production and the absolute SCET. The means:

- The time for stamping the Science data/HK TM packets is read when the first word of the science data has been acquired from the PEM. That means all TM packets containing a -M or -H slice and the M-PEM and H-PEM HK have the same (identical) SCET.
- The time for stamping the event TM packets are read immediately (few  $\mu$ sec) after event occurrence.
- The time for stamping the HK TM packets are read immediately after acquiring the HK.
- The accuracy for Science and HK TM time stamping is better than about 20ms.

## 2 Instrument Operating Modes

### 2.1 Operative Mode definition

VIRTIS Modes are defined in compliance with requirements expressed in Sect. 2.8.4.3 of RD1. i.e. distinct modes are to be defined where at least one of the following applies:

- Different resource usage (e.g. power, data rate, SSMM demand);
- Specific requirements put on the S/C (e.g. pointing);
- Different operative phase for the instrument.

As required in Sect. 2.8.3.2.3 of RD1, the H/K TMs provide a specific parameter "VIRTIS Mode Id" that unambiguously identifies the instrument mode of operation. This parameter is contained in the "default" H/K report with the following format:

ME Operative Mode				V-H Operative Mode						V-M Operative Mode					
b <sub>0</sub>	b <sub>1</sub>	B <sub>2</sub>	b <sub>3</sub>	b <sub>4</sub>	b <sub>5</sub>	b <sub>6</sub>	b <sub>7</sub>	b <sub>8</sub>	b <sub>9</sub>	b <sub>10</sub>	b <sub>11</sub>	b <sub>12</sub>	b <sub>13</sub>	b <sub>14</sub>	b <sub>15</sub>
1 ME_Off				1 H_Off						1 M_Off					
2 ME_Safe				2 H_Cool_Down						2 M_Cool_Down					
3 ME_Development				3 H_Idle						3 M_Idle					
4 ME_Idle				4 H_Annealing						4 M_Annealing					
5 ME_Science				5 H_PEM_On						5 M_PEM_On					
6 ME_Test				6 H_Test						6 M_Test					
				7 H_Calibration						7 M_Calibration					
				8 H_Nominal_Simulation						8 M_Science_High_Spectral_1					
				9 H_Science_Maximum_Data_Rate						9 M_Science_High_Spectral_2					
				10 H_Science_Nominal_Data_Rate						10 M_Science_High_Spectral_3					
				11 H_Science_Minimum_Data_Rate						11 M_Science_High_Spatial_1					
				12 DELETED						12 M_Science_High_Spatial_2					
				13 H_Science_Backup						13 M_Science_High_Spatial_3					
				14 H_User_Defined						14 M_Science_Nominal_1					
				15 DELETED						15 M_Science_Nominal_2					
				16 DELETED						16 M_Science_Nominal_3					
				17 DELETED						17 M_Science_Nominal_Compressed					
				18 H_Spectral_Calibration_Simulation						18 M_Science_Reduced_Slit					
				19: H_Degraded (**)						19 M_User_Defined					
				63 H_ME_Test (*)						20: M_Degraded (**)					
										63 M_ME_Test (*)					

(\*) H\_ME\_Test and M\_ME\_Test, which physically correspond to have PEM off but IFE on, is used in Test modes.

(\*\*) H\_Degraded and M\_Degraded are used when HS link is not available and therefore science data are sent on RTU Link

TAB. 2: VIRTIS Mode Id



A VIRTIS Mode is a unique combination of these 3 fields. All the combinations are possible, but not all combinations are used. Used combinations during science operations are listed in **TAB. 3**, according to the following suitable/advisable rules respect to a logical use of the instrument:

- If V-X mode is Cool\_Down, V-Y mode should be only Off or Cool\_Down or Idle;
- If V-X mode is Annealing, V-Y mode should be only Off or Idle;
- If V-X mode is Idle, V-Y mode should be only Off or Idle;
- If V-X mode is Test, V-Y mode should be only Test as well. (Test mode is used to command the PEMs bypassing the standard ME processing; commands to both PEMs are accepted without causing mode transitions: the only consistent way to do that is to consider both PEMs in Test mode);
- If V-X mode is Calibration, V-Y mode should be only Off or Idle;
- If V-X mode is one of Science modes, V-Y mode should be only Off or Idle or one of the Science modes;
- If ME mode is Off, Safe, Development or Test, then both PEMs are Off.

VIRTIS Modes having common properties are classified as belonging to the same Mode Group (first column of TAB. 3). This is a naming convention to address without ambiguity general statements, which are valid in different modes (e.g., “all Science modes” means “all modes of the Science Mode Group”).

VIRTIS					ME			V-H				V-M			
Mode Group	Mode ID [HEX]	Overall HK Data Rate [kbits/s] (1)	Overall Science Max Data Rate [kbits/s] (2)	Overall Max Power [w] (3) (6) (7) (8) (9)	Mode	HK Data Rate [kbits/s]	Power [w] (3) (6) (7) (8) (9)	Mode	HK Data Rate [kbits/s]	Science Data Rate [kbits/s]	Power [w] (4) (3) (6) (7) (8) (9)	Mode	HK Data Rate [kbits/s]	Science Data Rate [kbits/s]	Power [w] (4) (3) (6) (7) (8) (9)
Off		/	/	/	ME_Off	/	/	H_Off	/	/	/	M_Off	/	/	/
Safe		0.025	/	6.1	ME_Safe	0.025	6.1	H_Off	/	/	/	M_Off	/	/	/
SW Upload		0.125	/	9.8	ME_Safe	0.125	9.8	H_Off	/	/	/	M_Off	/	/	/
Download		0.125	/	9.8	ME_Safe	0.125	9.8	H_Off	/	/	/	M_Off	/	/	/
Idle		0.025	/	6.4	ME_Idle	0.025	6.4	H_Off	/	/	/	M_Off	/	/	/
Idle		0.176	/	17	ME_Idle	0.025	6.6	H_Off	/	/	/	M_PEM_On	0.151	/	10.4
Idle		0.176	/	35.5	ME_Idle	0.025	6.6	H_Off	/	/	/	M_Idle	0.151	/	28.9 / 24.4
Idle		0.126	/	12.7	ME_Idle	0.025	6.5	H_PEM_On	0.101	/	6.2	M_Off	/	/	/
Idle		0.277	/	23.3	ME_Idle	0.025	6.7	H_PEM_On	0.101	/	6.2	M_PEM_On	0.151	/	10.4
Idle		0.126	/	29.4	ME_Idle	0.025	6.5	H_Idle	0.101	/	22.7 / 16.4	M_Off	/	/	/
Idle		0.272	/	58.3	ME_Idle	0.025	6.7	H_Idle	0.101	/	22.7 / 16.4	M_Idle	0.151	/	28.9 / 24.4
Cool_Down @75K		0.078	/	25.1	ME_Idle	0.025	6.6	H_Off	/	/	/	M_Cool_Down	0.053	/	18.5 / 14
Cool_Down @75K		0.078	/	23.0	ME_Idle	0.025	6.5	H_Cool_Down	0.053	/	16.5 / 11.2	M_Off	/	/	/
Cool_Down @75K		0.131	/	41.7	ME_Idle	0.025	6.7	H_Cool_Down	0.053	/	16.5 / 11.2	M_Cool_Down	0.053	/	18.5 / 14
Annealing		0.176	/	19.6	ME_Idle	0.025	6.6	H_Off	/	/	/	M_Annealing	0.151	/	13
Annealing		0.126	/	15.7	ME_Idle	0.025	6.5	H_Annealing	0.101	/	9.2	M_Off	/	/	/
Annealing		0.277	/	28.9	ME_Idle	0.025	6.7	H_Annealing	0.101	/	9.2	M_Annealing	0.151	/	13
Calibration		0.197	169	41.8	ME_Science	0.025	10	H_Off	/	/	/	M_Calibration	0.172	169	31.8
Calibration		0.297	169	59.6	ME_Science	0.025	10.4	H_Idle	0.101	/	17.4	M_Calibration	0.172	169	31.8
Calibration		0.150	45.6	29.1	ME_Science	0.025	9.9	H_Calibration	0.125	45.6	19.2	M_Off	/	/	/
Calibration		0.301	45.6	54	ME_Science	0.025	10.4	H_Calibration	0.125	45.6	19.2	M_Idle	0.151	/	24.4
Science		0.353	89	38.8	ME_Science	0.025	10	H_Off	/	/	/	M_Science_High_Spectral_1	0.328	89	28.8
Science		0.203	23	38.8	ME_Science	0.025	10	H_Off	/	/	/	M_Science_High_Spectral_2	0.177	23	28.8
Science		0.169	8	38.8	ME_Science	0.025	10	H_Off	/	/	/	M_Science_High_Spectral_3	0.144	8	28.8
Science		0.353	118	38.8	ME_Science	0.025	10	H_Off	/	/	/	M_Science_High_Spatial_1	0.328	118	28.8
Science		0.203	30	38.8	ME_Science	0.025	10	H_Off	/	/	/	M_Science_High_Spatial_2	0.177	30	28.8

VIRTIS					ME			V-H				V-M			
Mode Group	Mode ID [HEX]	Overall HK Data Rate [kbits/s] (1)	Overall Science Max Data Rate [kbits/s] (2)	Overall Max Power [w] (3) (6) (7) (8) (9)	Mode	HK Data Rate [kbits/s]	Power [w] (3) (6) (7) (8) (9)	Mode	HK Data Rate [kbits/s]	Science Data Rate [kbits/s]	Power [w] (4) (3) (6) (7) (8) (9)	Mode	HK Data Rate [kbits/s]	Science Data Rate [kbits/s]	Power [w] (4) (3) (6) (7) (8) (9)
Science		0.169	10	38.8	ME_Science	0.025	10	H_Off	/	/	/	M_Science_High_Spatial_3	0.144	10	28.8
Science		0.353	30	38.8	ME_Science	0.025	10	H_Off	/	/	/	M_Science_Nominal_1	0.328	30	28.8
Science		0.203	8	38.8	ME_Science	0.025	10	H_Off	/	/	/	M_Science_Nominal_2	0.177	8	28.8
Science		0.169	3	38.8	ME_Science	0.025	10	H_Off	/	/	/	M_Science_Nominal_3	0.144	3	28.8
Science		0.353	3.6	38.8	ME_Science	0.025	10	H_Off	/	/	/	M_Science_Nominal_Compressed	0.130 / 0.328	0.03 / 3.6	28.8
Science		0.353	30	38.8	ME_Science	0.025	10	H_Off	/	/	/	M_Science_Reduced_Slit	0.130 / 0.328	3 / 30	28.8
Science		0.454	89	46.2	ME_Science	0.025	10.4	H_Idle	0.101	/	17.4	M_Science_High_Spectral_1	0.328	89	28.8
Science		0.304	23	46.2	ME_Science	0.025	10.4	H_Idle	0.101	/	17.4	M_Science_High_Spectral_2	0.177	23	28.8
Science		0.270	8	46.2	ME_Science	0.025	10.4	H_Idle	0.101	/	17.4	M_Science_High_Spectral_3	0.144	8	28.8
Science		0.454	118	46.2	ME_Science	0.025	10.4	H_Idle	0.101	/	17.4	M_Science_High_Spatial_1	0.328	118	28.8
Science		0.304	30	46.2	ME_Science	0.025	10.4	H_Idle	0.101	/	17.4	M_Science_High_Spatial_2	0.177	30	28.8
Science		0.270	10	46.2	ME_Science	0.025	10.4	H_Idle	0.101	/	17.4	M_Science_High_Spatial_3	0.144	10	28.8
Science		0.454	30	46.2	ME_Science	0.025	10.4	H_Idle	0.101	/	17.4	M_Science_Nominal_1	0.328	30	28.8
Science		0.304	8	46.2	ME_Science	0.025	10.4	H_Idle	0.101	/	17.4	M_Science_Nominal_2	0.177	8	28.8
Science		0.270	3	46.2	ME_Science	0.025	10.4	H_Idle	0.101	/	17.4	M_Science_Nominal_3	0.144	3	28.8
Science		0.454	3.6	46.2	ME_Science	0.025	10.4	H_Idle	0.101	/	17.4	M_Science_Nominal_Compressed	0.130 / 0.328	0.03 / 3.6	28.8
Science		0.454	30	46.2	ME_Science	0.025	10.4	H_Idle	0.101	/	17.4	M_Science_Reduced_Slit	0.130 / 0.328	3 / 30	28.8
Science		1.2	87	28.8	ME_Science	0.025	9.9	H_Science_Maximum_Data_Rate	1.175	28 / 87	18.9	M_Off	/	/	
Science		1.351	87	53.7	ME_Science	0.025	10.4	H_Science_Maximum_Data_Rate	1.175	28 / 87	18.9	M_Idle	0.151	/	24.4
Science		1.528	176	58.1	ME_Science	0.025	10.4	H_Science_Maximum_Data_Rate	1.175	28 / 87	18.9	M_Science_High_Spectral_1	0.328	89	28.8
Science		1.377	117	58.1	ME_Science	0.025	10.4	H_Science_Maximum_Data_Rate	1.175	28 / 87	18.9	M_Science_High_Spectral_2	0.177	23	28.8
Science		1.344	95	58.1	ME_Science	0.025	10.4	H_Science_Maximum_Data_Rate	1.175	28 / 87	18.9	M_Science_High_Spectral_3	0.144	8	28.8
Science		1.528	205	58.1	ME_Science	0.025	10.4	H_Science_Maximum_Data_Rate	1.175	28 / 87	18.9	M_Science_High_Spatial_1	0.328	118	28.8
Science		1.377	117	58.1	ME_Science	0.025	10.4	H_Science_Maximum_Data_Rate	1.175	28 / 87	18.9	M_Science_High_Spatial_2	0.177	30	28.8
Science		1.344	97	58.1	ME_Science	0.025	10.4	H_Science_Maximum_Data_Rate	1.175	28 / 87	18.9	M_Science_High_Spatial_3	0.144	10	28.8
Science		1.528	117	58.1	ME_Science	0.025	10.4	H_Science_Maximum_Data_Rate	1.175	28 / 87	18.9	M_Science_Nominal_1	0.328	30	28.8
Science		1.377	95	58.1	ME_Science	0.025	10.4	H_Science_Maximum_Data_Rate	1.175	28 / 87	18.9	M_Science_Nominal_2	0.177	8	28.8
Science		1.344	90	58.1	ME_Science	0.025	10.4	H_Science_Maximum_Data_Rate	1.175	28 / 87	18.9	M_Science_Nominal_3	0.144	3	28.8
Science		1.528	90.6	58.1	ME_Science	0.025	10.4	H_Science_Maximum_Data_Rate	1.175	28 / 87	18.9	M_Science_Nominal_Compressed	0.130 / 0.328	0.03 / 3.6	28.8
Science		1.528	117	58.1	ME_Science	0.025	10.4	H_Science_Maximum_Data_Rate	1.175	28 / 87	18.9	M_Science_Reduced_Slit	0.130 / 0.328	3 / 30	28.8

VIRTIS					ME			V-H				V-M			
Mode Group	Mode ID [HEX]	Overall HK Data Rate [kbits/s] (1)	Overall Science Max Data Rate [kbits/s] (2)	Overall Max Power [w] (3) (6) (7) (8) (9)	Mode	HK Data Rate [kbits/s]	Power [w] (3) (6) (7) (8) (9)	Mode	HK Data Rate [kbits/s]	Science Data Rate [kbits/s]	Power [w] (4) (3) (6) (7) (8) (9)	Mode	HK Data Rate [kbits/s]	Science Data Rate [kbits/s]	Power [w] (4) (3) (6) (7) (8) (9)
Science		0.390	27	28.8	ME_Science	0.025	9.9	H_Science_Nominal_Data_Rate	0.365	3.5 / 27	18.9	M_Off	/	/	
Science		0.541	27	53.7	ME_Science	0.025	10.4	H_Science_Nominal_Data_Rate	0.365	3.5 / 27	18.9	M_Idle	0.151	/	24.4
Science		0.718	116	58.1	ME_Science	0.025	10.4	H_Science_Nominal_Data_Rate	0.365	3.5 / 27	18.9	M_Science_High_Spectral_1	0.328	89	28.8
Science		0.567	50	58.1	ME_Science	0.025	10.4	H_Science_Nominal_Data_Rate	0.365	3.5 / 27	18.9	M_Science_High_Spectral_2	0.177	23	28.8
Science		0.534	35	58.1	ME_Science	0.025	10.4	H_Science_Nominal_Data_Rate	0.365	3.5 / 27	18.9	M_Science_High_Spectral_3	0.144	8	28.8
Science		0.718	145	58.1	ME_Science	0.025	10.4	H_Science_Nominal_Data_Rate	0.365	3.5 / 27	18.9	M_Science_High_Spatial_1	0.328	118	28.8
Science		0.567	57	58.1	ME_Science	0.025	10.4	H_Science_Nominal_Data_Rate	0.365	3.5 / 27	18.9	M_Science_High_Spatial_2	0.177	30	28.8
Science		0.534	37	58.1	ME_Science	0.025	10.4	H_Science_Nominal_Data_Rate	0.365	3.5 / 27	18.9	M_Science_High_Spatial_3	0.144	10	28.8
Science		0.718	57	58.1	ME_Science	0.025	10.4	H_Science_Nominal_Data_Rate	0.365	3.5 / 27	18.9	M_Science_Nominal_1	0.328	30	28.8
Science		0.567	35	58.1	ME_Science	0.025	10.4	H_Science_Nominal_Data_Rate	0.365	3.5 / 27	18.9	M_Science_Nominal_2	0.177	8	28.8
Science		0.534	30	58.1	ME_Science	0.025	10.4	H_Science_Nominal_Data_Rate	0.365	3.5 / 27	18.9	M_Science_Nominal_3	0.144	3	28.8
Science		0.718	30.6	58.1	ME_Science	0.025	10.4	H_Science_Nominal_Data_Rate	0.365	3.5 / 27	18.9	M_Science_Nominal_Compressed	0.130 / 0.328	0.03 / 3.6	28.8
Science		0.718	57	58.1	ME_Science	0.025	10.4	H_Science_Nominal_Data_Rate	0.365	3.5 / 27	18.9	M_Science_Reduced_Slit	0.130 / 0.328	3 / 30	28.8
Science		0.126	3.4	28.8	ME_Science	0.025	9.9	H_Science_Minimum_Data_Rate	0.101	3.4	18.9	M_Off	/	/	
Science		0.277	3.4	53.7	ME_Science	0.025	10.4	H_Science_Minimum_Data_Rate	0.101	3.4	18.9	M_Idle	0.151	/	24.4
Science		0.454	93.4	58.1	ME_Science	0.025	10.4	H_Science_Minimum_Data_Rate	0.101	3.4	18.9	M_Science_High_Spectral_1	0.328	89	28.8
Science		0.303	26.4	58.1	ME_Science	0.025	10.4	H_Science_Minimum_Data_Rate	0.101	3.4	18.9	M_Science_High_Spectral_2	0.177	23	28.8
Science		0.270	11.4	58.1	ME_Science	0.025	10.4	H_Science_Minimum_Data_Rate	0.101	3.4	18.9	M_Science_High_Spectral_3	0.144	8	28.8
Science		0.454	121.4	58.1	ME_Science	0.025	10.4	H_Science_Minimum_Data_Rate	0.101	3.4	18.9	M_Science_High_Spatial_1	0.328	118	28.8
Science		0.303	33.4	58.1	ME_Science	0.025	10.4	H_Science_Minimum_Data_Rate	0.101	3.4	18.9	M_Science_High_Spatial_2	0.177	30	28.8
Science		0.270	13.4	58.1	ME_Science	0.025	10.4	H_Science_Minimum_Data_Rate	0.101	3.4	18.9	M_Science_High_Spatial_3	0.144	10	28.8
Science		0.454	33.4	58.1	ME_Science	0.025	10.4	H_Science_Minimum_Data_Rate	0.101	3.4	18.9	M_Science_Nominal_1	0.328	30	28.8
Science		0.303	11.4	58.1	ME_Science	0.025	10.4	H_Science_Minimum_Data_Rate	0.101	3.4	18.9	M_Science_Nominal_2	0.177	8	28.8
Science		0.270	6.4	58.1	ME_Science	0.025	10.4	H_Science_Minimum_Data_Rate	0.101	3.4	18.9	M_Science_Nominal_3	0.144	3	28.8
Science		0.454	7	58.1	ME_Science	0.025	10.4	H_Science_Minimum_Data_Rate	0.101	3.4	18.9	M_Science_Nominal_Compressed	0.130 / 0.328	0.03 / 3.6	28.8
Science		0.454	33.4	58.1	ME_Science	0.025	10.4	H_Science_Minimum_Data_Rate	0.101	< 3.4	18.9	M_Science_Reduced_Slit	0.130 / 0.328	3 / 30	28.8
Science		0.277	354	28.8	ME_Science	0.025	9.9	H_Science_Backup	0.252	< 354	18.9	M_Off	/	/	
Science		0.428	354	53.7	ME_Science	0.025	10.4	H_Science_Backup	0.252	< 354	18.9	M_Idle	0.151	/	24.4
Science		0.605	443	58.1	ME_Science	0.025	10.4	H_Science_Backup	0.252	< 354	18.9	M_Science_High_Spectral_1	0.328	89	28.8
Science		0.454	377	58.1	ME_Science	0.025	10.4	H_Science_Backup	0.252	< 354	18.9	M_Science_High_Spectral_2	0.177	23	28.8
Science		0.421	362	58.1	ME_Science	0.025	10.4	H_Science_Backup	0.252	< 354	18.9	M_Science_High_Spectral_3	0.144	8	28.8

VIRTIS					ME			V-H				V-M			
Mode Group	Mode ID [HEX]	Overall HK Data Rate [kbits/s] (1)	Overall Science Max Data Rate [kbits/s] (2)	Overall Max Power [w] (3) (6) (7) (8) (9)	Mode	HK Data Rate [kbits/s]	Power [w] (3) (6) (7) (8) (9)	Mode	HK Data Rate [kbits/s]	Science Data Rate [kbits/s]	Power [w] (4) (3) (6) (7) (8) (9)	Mode	HK Data Rate [kbits/s]	Science Data Rate [kbits/s]	Power [w] (4) (3) (6) (7) (8) (9)
Science		0.605	472	58.1	ME_Science	0.025	10.4	H_Science_Backup	0.252	< 354	18.9	M_Science_High_Spatial_1	0.328	118	28.8
Science		0.454	384	58.1	ME_Science	0.025	10.4	H_Science_Backup	0.252	< 354	18.9	M_Science_High_Spatial_2	0.177	30	28.8
Science		0.421	364	58.1	ME_Science	0.025	10.4	H_Science_Backup	0.252	< 354	18.9	M_Science_High_Spatial_3	0.144	10	28.8
Science		0.605	384	58.1	ME_Science	0.025	10.4	H_Science_Backup	0.252	< 354	18.9	M_Science_Nominal_1	0.328	30	28.8
Science		0.454	362	58.1	ME_Science	0.025	10.4	H_Science_Backup	0.252	< 354	18.9	M_Science_Nominal_2	0.177	8	28.8
Science		0.421	357	58.1	ME_Science	0.025	10.4	H_Science_Backup	0.252	< 354	18.9	M_Science_Nominal_3	0.144	3	28.8
Science		0.605	357.6	58.1	ME_Science	0.025	10.4	H_Science_Backup	0.252	< 354	18.9	M_Science_Nominal_Compressed	0.130 / 0.328	0.03 / 3.6	28.8
Science		0.605	384	58.1	ME_Science	0.025	10.4	H_Science_Backup	0.252	< 354	18.9	M_Science_Reduced_Slit	0.130 / 0.328	3 / 30	28.8
Science		1.2	83.4	28.8	ME_Science	0.025	9.9	H_Nominal_Simulation	1.175	83.4	18.9	M_Off	/	/	/
Science		1.2	83.4	28.8	ME_Science	0.025	9.9	H_Spectral_Calibration Simulation	1.175	83.4	18.9	M_Off	/	/	/
Science		0.908	1814	58.1	ME_Science	0.025	10.4	H_Science_Backup	0.252	<354	18.9	M_User_defined	0.656	< 1460	28.8
Science		1.856	1543.4	58.1	ME_Science	0.025	10.4	H_User_defined	1.175	83.4	18.9	M_User_defined	0.656	< 1460	28.8
Science (5)		113.4	/	58.1	ME_Science	0.025	10.4	H_Degraded	83.4	/		M_Degraded	30	/	28.8
Test		0.908	1814	58.1	ME_Science	0.025	10.4	H_Test	0.252	< 354	18.9	M_Test	0.628	< 1460	28.8
Test		0.681	1460	38.9	ME_Science	0.025	10.1	H_Off	/	/		M_Test	0.628	< 1460	28.8
Test		0.277	354	58.1	ME_Science	0.025	9.9	H_Test	0.252	< 354	18.9	M_Off	/	/	
Test		0.025	/	6.7	ME_Test	0.025	6.7	H_Off	/	/	/	M_Off	/	/	/
Test		0.555	1460	6.7	ME_Test	0.025	6.7	H_Off	/	/	/	M_ME_Test	0.202	< 1460	/
Test		0.227	730	6.7	ME_Test	0.025	6.7	H_ME_Test	0.202	< 730	/	M_Off	/	/	/
Test		0.606	2190	6.7	ME_Test	0.025	6.7	H_ME_Test	0.202	< 730	/	M_ME_Test	0.404	<1460	/

TAB. 3 VIRTIS Operative Modes

**NOTES to TAB. 3:**

- (1) Computed as: ME H/K Data Rate + V-H H/K Data Rate + V-M H/K Data Rate.  
The H/K period is assumed to be 10 s
- (2) In mode Test(ME\_Science, H\_Off, M\_Off), the ME can produce a worst case data rate 115.2 kb/s.  
In modes Test(ME\_Test, \*, \*), there is no data production, therefore the PEMS data rate is entirely from H/K.  
In all other modes, the overall data rate is computed as: V-H Science Data Rate + V-M Science Data Rate
- (3) Computed as: ME Power + V-H Power + V-M Power + 2.5 w auxiliary circuits
- (4) Cooler power is included depending on the mode (see TAB. 4, 5 and 6).
- (5) This degraded mode is used when HS link is not available; therefore, both HK and Science data are sent to the RTU link; the overall data rate on this link (HK+Science) is 1,9 Kbit/s
- (6) All the value are calculated with coolers in closed loop @75K in S/C hot condition
- (7) During M-Cover operation add 11W (30sec max peak), possible in all modes
- (8) During H-Cover operation add 6.5W (30sec max peak), possible in all modes
- (9) All modes with science acquisition are referred to cooler in steady state

Data specific to the ME, V-M and V-H subsystems, reported in **TAB. 3**, are collected from the following TAB. 4, 5 and 6.

Mode	Id	HK Data Rate [kbits/s]	Power [w] (1)
ME_Off	1	0	0
ME_Safe	2	0.025	6.1
ME_Safe (during service 6)	2	0.125	9.8
ME_Development	3	N/A (2)	N/A (2)
ME_Idle (only ME on)	4	0.025	6.4
ME_Idle (-H on)	4	0.025	6.5
ME_Idle (-M on)	4	0.025	6.6
ME_Idle (-H-M on)	4	0.025	6.7
ME_Science (-H science)	5	0.025	9.9
ME_Science(-M science)	5	0.025	10
ME_Science(-H-M science)	5	0.025	10.4
ME_Test	6	0.025	10.5

TAB. 4: ME Operative Modes

**NOTES to TAB. 4:**

- (1) Intended as power consumption on +28V bus.
- (2) Not used at experiment level



M-MODE		M_IFE_MODE	M_COOLER_MODE (commanded by TC)	M_PEM_VIS_MODE M_PEM_IR_MODE	M_DATA_PRODUCT_PARAM (MODE) (commanded by TC)	M_ACQ_MODE (commanded by TC)	M_COMP_MODE, M_ERT (commanded by TC)
1	M_OFF	M_IFE_OFF   M_IFE_ON	M_COOLER_OFF	M_PEM_VIS_OFF && M_PEM_IR_OFF	M_DATA_NO	-	-
2	M_COOL_DOWN	M_IFE_ON	M_COOLER_STAND_BY    M_COOLER_OPEN_LOOP    M_COOLER_CLOSED_LOOP	M_PEM_VIS_OFF && M_PEM_IR_OFF	M_DATA_NO	-	-
3	M_IDLE	M_IFE_ON	M_COOLER_STAND_BY    M_COOLER_OPEN_LOOP    M_COOLER_CLOSED_LOOP	M_PEM_VIS_ON    M_PEM_IR_IDLE	M_DATA_NO	-	-
4	M_ANNEALING	M_IFE_ON	M_COOLER_OFF	M_PEM_IR_ANNEALING	M_DATA_NO	-	-
5	M_PEM_ON	M_IFE_ON	M_COOLER_OFF	M_PEM_VIS_ON && M_PEM_IR_ON	M_DATA_NO	-	-
6	M_TEST	M_IFE_ON	M_COOLER_ANY_MODE	M_PEM_VIS_ON    M_PEM_IR_ON	M_DATA_TEST	-	-
7	M_CALIBRATION	M_IFE_ON	M_COOLER_OPEN_LOOP    M_COOLER_CLOSED_LOOP	M_PEM_VIS_ON    M_PEM_IR_FULL_WINDOW	M_DATA_CALIBRATION	M_ACQ_MODE_ ALL_PIX_FULL_WIN	M_NO_COMPRESSION
8	M_SCIENCE_ HIGH_SPECTRAL_1	M_IFE_ON	M_COOLER_OPEN_LOOP    M_COOLER_CLOSED_LOOP	M_PEM_VIS_ON    M_PEM_IR_FULL_WINDOW	M_DATA_SCIENCE	M_ACQ_MODE_HIGH_ SPECTRAL_1X4_FULL_WIN	M_LOSSLESS_COMPRESSION && M_ERT = 0 (5sec)
9	M_SCIENCE_ HIGH_SPECTRAL_2	M_IFE_ON	M_COOLER_OPEN_LOOP    M_COOLER_CLOSED_LOOP	M_PEM_VIS_ON    M_PEM_IR_FULL_WINDOW	M_DATA_SCIENCE	M_ACQ_MODE_HIGH_ SPECTRAL_1X4_FULL_WIN	M_LOSSLESS_COMPRESSION && M_ERT = 1 (20sec)
10	M_SCIENCE_ HIGH_SPECTRAL_3	M_IFE_ON	M_COOLER_OPEN_LOOP    M_COOLER_CLOSED_LOOP	M_PEM_VIS_ON    M_PEM_IR_FULL_WINDOW	M_DATA_SCIENCE	M_ACQ_MODE_HIGH_ SPECTRAL_1X4_FULL_WIN	M_LOSSLESS_COMPRESSION && M_ERT = 2 (60sec)
11	M_SCIENCE_ HIGH_SPATIAL_1	M_IFE_ON	M_COOLER_OPEN_LOOP    M_COOLER_CLOSED_LOOP	M_PEM_VIS_ON    M_PEM_IR_FULL_WINDOW	M_DATA_SCIENCE	M_ACQ_MODE_HIGH_ SPATIAL_3X1_FULL_WIN	M_LOSSLESS_COMPRESSION && M_ERT = 0 (5sec)
12	M_SCIENCE_ HIGH_SPATIAL_2	M_IFE_ON	M_COOLER_OPEN_LOOP    M_COOLER_CLOSED_LOOP	M_PEM_VIS_ON    M_PEM_IR_FULL_WINDOW	M_DATA_SCIENCE	M_ACQ_MODE_HIGH_ SPATIAL_3X1_FULL_WIN	M_LOSSLESS_COMPRESSION && M_ERT = 1 (20sec)
13	M_SCIENCE_ HIGH_SPATIAL_3	M_IFE_ON	M_COOLER_OPEN_LOOP    M_COOLER_CLOSED_LOOP	M_PEM_VIS_ON    M_PEM_IR_FULL_WINDOW	M_DATA_SCIENCE	M_ACQ_MODE_HIGH_ SPATIAL_3X1_FULL_WIN	M_LOSSLESS_COMPRESSION && M_ERT = 2 (60sec)
14	M_SCIENCE_ NOMINAL_1	M_IFE_ON	M_COOLER_OPEN_LOOP    M_COOLER_CLOSED_LOOP	M_PEM_VIS_ON    M_PEM_IR_FULL_WINDOW	M_DATA_SCIENCE	M_ACQ_MODE_NOMINAL_3X4_FULL_WIN    M_ACQ_MODE_VIS_ONLY_1X4	M_LOSSLESS_COMPRESSION && M_ERT = 0 (5sec)
15	M_SCIENCE_ NOMINAL_2	M_IFE_ON	M_COOLER_OPEN_LOOP    M_COOLER_CLOSED_LOOP	M_PEM_VIS_ON    M_PEM_IR_FULL_WINDOW	M_DATA_SCIENCE	M_ACQ_MODE_IR_ONLY_1X4    M_ACQ_MODE_ALTER_IR_ONLY_1X4	M_LOSSLESS_COMPRESSION && M_ERT = 1 (20sec)
16	M_SCIENCE_ NOMINAL_3	M_IFE_ON	M_COOLER_OPEN_LOOP    M_COOLER_CLOSED_LOOP	M_PEM_VIS_ON    M_PEM_IR_FULL_WINDOW	M_DATA_SCIENCE		M_LOSSLESS_COMPRESSION && M_ERT = 2 (60sec)
17	M_SCIENCE_ NOMINAL_COMPRESSED	M_IFE_ON	M_COOLER_OPEN_LOOP    M_COOLER_CLOSED_LOOP	M_PEM_VIS_ON    M_PEM_IR_FULL_WINDOW	M_DATA_SCIENCE	M_ACQ_MODE_ NOMINAL_3X4_FULL_WIN	M_WAVELET_F1_COMPRESSION    M_WAVELET_F2_COMPRESSION    M_WAVELET_F3_COMPRESSION
18	M_SCIENCE_ REDUCED_SLIT	M_IFE_ON	M_COOLER_OPEN_LOOP    M_COOLER_CLOSED_LOOP	M_PEM_VIS_ON    M_PEM_IR_FULL_WINDOW	M_DATA_SCIENCE	M_ACQ_MODE_ REDUCED_SLIT_3X1	M_LOSSLESS_COMPRESSION
19	M_USER_DEFINED	M_IFE_ON	Any other combinations except these which are applicable for mode 1...18 and 63				
20	M_DEGRADED	M_IFE_ON	M_COOLER_OPEN_LOOP    M_COOLER_CLOSED_LOOP	M_PEM_VIS_ON    M_PEM_IR_FULL_WINDOW	M_DATA_SCIENCE	-	-M data transfer via RTU link is active by TC_ENABLE_SCIENCE_RTU(M)
63	M_ME_TEST	M_IFE_ DIAGNOSE	M_COOLER_ANY_MODE	M_PEM_ANY_MODE	M_DATA_IFE_TEST_ PATTERN	-	-

TAB. 5 V-M Operative Modes (part 1)



M-MODE		M-Science TM Data Format (1)	Max. M-Science TM Data Rate (2)	M-HK TM format	Max. M-HK TM Data Rate (3)	Remark	
1	M_OFF	N/A	N/A	N/A	N/A	No science data transfer to S/C	
2	M_COOL_DOWN	N/A	N/A	MTM_ME_General_HK = 16words/10s	53bit/s		
3	M_IDLE	N/A	N/A	(MTM_PEM_IR_HK + MTM_PEM_VIS_HK) / 10s +	151bit/s		
4	M_ANNEALING	N/A	N/A	MTM_ME_General_HK / 10s = (29+34)words/10s +			
5	M_PEM_ON	N/A	N/A	16words/10s			
6	M_TEST	depends on -M operational parameter (max. 1 VIS + 1 IR Slice every M_ERT=2.5s, 5s, 20s, 60s or 300s not compressed, i.e. 12 VIS + 12 IR SSLs, 456 TM packets)	0,03 ... 1460Kbit/s	(MTM_PEM_IR_HK + MTM_PEM_VIS_HK) / M_ERT + (MTM_PEM_IR_HK + MTM_PEM_VIS_HK) / 10s + MTM_ME_General_HK / 10s = (29+34)words/2.5s...300s + (29+34)words/10s + 16words/10s	130...656Bit/s	Science data are transferred by HS link to S/C, TC_Enable_Science_HS_Link (-M) is commanded	
7	M_CALIBRATION	5 x (7 VIS + 7 IR) Slices only <u>once</u> (i.e. 5 x (84 VIS + 84 IR) SSLs or 15960 TM packets, <u>not</u> compressed)	< 169Kbit/s (131Mbit once within min. 775s)	7 * 5 * (29+34)words/775s + (29+34)words/10s + 16words/10s	172Bit/s		
8	M_SCIENCE_HIGH_SPECTRAL_1	1 VIS + 1 IR Slice every M_ERT=5s (i.e. 3 VIS + 3 IR SSLs or < 60 TM packets depends on lossless compression factor > 2)	< 89Kbit/s	(29+34)words/5s + (29+34)words/10s + 16words/10s	328Bit/s		
9	M_SCIENCE_HIGH_SPECTRAL_2	every M_ERT=20s	< 23Kbit/s	(29+34)words/20s + (29+34)words/10s + 16words/10s	177Bit/s		
10	M_SCIENCE_HIGH_SPECTRAL_3	every M_ERT=60s	< 8Kbit/s	(29+34)words/60s + (29+34)words/10s + 16words/10s	144Bit/s		
11	M_SCIENCE_HIGH_SPATIAL_1	1 VIS + 1 IR Slice every M_ERT=5s (i.e. 4 VIS + 4 IR SSLs or < 80 TM packets depends on lossless compression factor > 2)	< 118Kbit/s	(29+34)words/5s + (29+34)words/10s + 16words/10s	328Bit/s		
12	M_SCIENCE_HIGH_SPATIAL_2	every M_ERT=20s	< 30Kbit/s	(29+34)words/20s + (29+34)words/10s + 16words/10s	177Bit/s		
13	M_SCIENCE_HIGH_SPATIAL_3	every M_ERT=60s	< 10Kbit/s	(29+34)words/60s + (29+34)words/10s + 16words/10s	144Bit/s		
14	M_SCIENCE_NOMINAL_1	1 VIS + 1 IR Slice every M_ERT=5s (i.e. 1 VIS + 1 IR SSL or < 20 TM packets depends on lossless compression factor > 2)	< 30Kbit/s	(29+34)words/5s + (29+34)words/10s + 16words/10s	328Bit/s		
15	M_SCIENCE_NOMINAL_2	every M_ERT=20s	< 8Kbit/s	(29+34)words/20s + (29+34)words/10s + 16words/10s	177Bit/s		
16	M_SCIENCE_NOMINAL_3	every M_ERT=60s	< 3Kbit/s	(29+34)words/60s + (29+34)words/10s + 16words/10s	144Bit/s		
17	M_SCIENCE_NOMINAL_COMPRESSED	1 VIS + 1 IR Slice every M_ERT=5s, 20s, 60s or 300s (i.e. 1 VIS + 1 IR SSL or 4...6 TM packets depends on <u>lossy</u> compr. factor = 8...16)	3,6 Kbit/s (5s, F1 compr.) ... 0,03Kbit/s (300s, F3 compr.)	(29+34)words/5s...300s + (29+34)words/10s + 16words/10s	130...328Bit/s		
18	M_SCIENCE_REDUCED_SLIT	1 VIS + 1 IR Slice every M_ERT=5s (i.e. 1 VIS + 1 IR SSL or < 20 TM packets depends on lossless compression factor > 2)	30Kbit/s (5s) ... 8Kbit/s (20s) ... 3Kbit/s (60s) 0,5Kbit/s (300s)	(29+34)words/5s...300s + (29+34)words/10s + 16words/10s	130...328Bit/s		
19	M_USER_DEFINED	depends on -M operational parameter (see M_TEST)	0,03 ... 1460Kbit/s	(29+34)words/5s...300s + (29+34)words/10s + 16words/10s	130...656Bit/s		
20	M_DEGRADED	1 VIS + 1 IR Slice every M_ERT=5s, 20s, 60s, 300s (i.e. 1...12 VIS + 1...12 IR SSLs or < 4...240 TM packets depends on ERT, compr. factor 2...16)	< 30Kbit/s (calculated by S/W, if > 35Kbit/s TC_Enable_Science_RTU_link is not accepted)	(29+34)words/5s...300s + (29+34)words/10s + 16words/10s	130...328Bit/s		Science data are transferred by RTU link to S/C, TC_Enable_Science_RTU_Link
63	M_ME_TEST	depends on VTC_Enter_Test_Mode parameter	0,03 ... 1460Kbit/s	(29+34)words/2.5s...300s	3...404Bit/s		Science data are transferred by HS link to S/C

TAB. 5: V-M Operative Modes (part 2)

Note on **TAB. 5**(part 2)

- (1) Science data TM packet size = 512 words. TM SCET is the SCET of the first word acquired from M-PEM
- (2) Data rate for summing factor M\_SS=1
- (3) if HK are enabled

H_MODE (2)	H_IFE_MODE	H_COOLER_MODE (commanded by TC)	H_PEM_MODE	H_DATA_PRODUCT_MODE (commanded by TC)	H_SCIENCE_DATA_RATE (1)	Science data to RTU_Link
1 H_OFF	H_IFE_OFF   H_IFE_ON	H_COOLER_OFF	H_PEM_OFF	H_DATA_NO	-	-
2 H_COOL_DOWN	H_IFE_ON	H_COOLER_STAND_BY    H_COOLER_OPEN_LOOP    H_COOLER_CLOSED_LOOP	H_PEM_OFF	H_DATA_NO	-	-
3 H_IDLE	H_IFE_ON	H_COOLER_STAND_BY    H_COOLER_OPEN_LOOP    H_COOLER_CLOSED_LOOP	H_PEM_ON    H_PEM_IDLE	H_DATA_NO	-	-
4 H_ANNEALING	H_IFE_ON	H_COOLER_OFF	H_PEM_IR_ANNEALING	H_DATA_NO	-	-
5 H_PEM_ON	H_IFE_ON	H_COOLER_OFF	H_PEM_ON	H_DATA_NO	-	-
6 H_TEST	H_IFE_ON	H_COOLER_ANY_MODE	Not equal H_PEM_OFF	H_DATA_TEST	-	-
7 H_CALIBRATION	H_IFE_ON	H_COOLER_OPEN_LOOP    H_COOLER_CLOSED_LOOP	Not equal H_PEM_OFF	H_DATA_CALIBRATION	H_NO_COMPRESSION	NO
8 H_NOMINAL_SIMULATION	H_IFE_ON	H_COOLER_ANY_MODE	Not equal H_PEM_OFF	H_DATA_NOMINAL_SIMULATION	-	NO
9 H_SCIENCE_MAXIMUM_DATA_RATE	H_IFE_ON	H_COOLER_OPEN_LOOP    H_COOLER_CLOSED_LOOP	Not equal H_PEM_OFF	H_DATA_NOMINAL_OBSERVATION	28 ... 87KBit/s	NO
10 H_SCIENCE_NOMINAL_DATA_RATE	H_IFE_ON	H_COOLER_OPEN_LOOP    H_COOLER_CLOSED_LOOP	Not equal H_PEM_OFF	H_DATA_NOMINAL_OBSERVATION	3.5 ... 27KBit/s	NO
11 H_SCIENCE_MINIMUM_DATA_RATE	H_IFE_ON	H_COOLER_OPEN_LOOP    H_COOLER_CLOSED_LOOP	Not equal H_PEM_OFF	H_DATA_NOMINAL_OBSERVATION	< 3.4KBit/s	NO
13 H_SCIENCE_BACKUP	H_IFE_ON	H_COOLER_OPEN_LOOP    H_COOLER_CLOSED_LOOP	Not equal H_PEM_OFF	H_DATA_SCIENCE_BACKUP	-	NO
14 H_USER_DEFINED	H_IFE_ON	Any other combinations except these which are applicable for mode 1...13, 18, 19 and 63				
18 H_SPECTRAL_CALIBRATION_SIMULATION	H_IFE_ON	H_COOLER_ANY_MODE	H_PEM_SIMULATION_FULL_MATRIX	H_DATA_SPECTRAL_CALIBRATION_SIMULATION	-	NO
19 H_DEGRADED	H_IFE_ON	H_COOLER_OPEN_LOOP    H_COOLER_CLOSED_LOOP	H_PEM_OBSERVATION_8ORDERS	H_DATA_NOMINAL_OBSERVATION	-	YES
63 H_ME_TEST	H_IFE_DIAGNOSE	H_COOLER_ANY_MODE	H_PEM_ANY_MODE	H_DATA_IFE_TEST_PATTERN	-	-

(1) is calculated by software:  $H\_SCIENCE\_DATA\_RATE = (H\_NR\_PIXEL\_PER\_ORDER * H\_NR\_ORDER * 16bit) / (H\_IRT * H\_COMP\_FACTOR * H\_NR\_SUM\_FRAME * 1024bit/s)$

H\_NR\_PIXEL\_PER\_ORDER = 432pixel  
 H\_NR\_ORDER = 8pixel

if H\_Sum = No  
 ( H\_NR\_SUM\_FRAME = 1  
 H\_NR\_FRAME = H\_OPERAT\_PARAM.H\_N\_FRAME )

$H\_IRT = (H\_OPERAT\_PARAM.H\_INT\_SCIENCE + H\_8ORDERS\_READOUT\_TIME + H\_HK\_READ\_OUT\_TIME + H\_IDLE\_TIME) * H\_NR\_FRAME$

if H\_Sum = Yes  
 ( H\_NR\_SUM\_FRAME = H\_OPERAT\_PARAM.H\_N\_SUM\_FRAME  
 H\_NR\_FRAME = 1)

H\_8ORDERS\_READOUT\_TIME = 284,58ms  
 H\_HK\_READ\_OUT\_TIME = 2,304ms  
 H\_IDLE\_TIME = 79,872ms

Note: the H\_Dark\_Rate is not considered for H\_SCIENCE\_DATA\_RATE calculation by S/W. The H\_Dark\_Rate is assumed as negligible.

TAB. 6: V-H Operative Modes (Part 1)

H-MODE		H-Science TM Data Format (1)	Max. H-Science TM Data Rate (2)	H-HK TM format (2)	Max. H-HK TM Data Rate (2)	Remark
1	H_OFF	N/A	N/A	N/A	N/A	No science data transfer to S/C
2	H_COOL_DOWN	N/A	N/A	H_General_HK/10sec = 16words/10s	53bit/s	
3	H_IDLE	N/A	N/A	H_PEM_HK/10sec + H_General_HK/10sec =	101bit/s	
4	H_ANNEALING	N/A	N/A	=		
5	H_PEM_ON	N/A	N/A	47words/10s + 16words/10s		
6	H_TEST	depends on -H operational parameter, the max. data rate is generated if a Image Slice is produced every 5s, not compressed, (i.e. 1 H_Image_Slice = 12 SSLs = 228 TM packets)	< 354KBit/s (if data rate is greater 354Kbit/s, TC_Enable_Science is not accepted to be commanded)	HTM_PEM_HK/IRT + HTM_PEM_HK/10sec + HTM_ME_General_HK/10sec = 47words/5s (min.IRT) + 47words/10s + 16words/10s	< 252Bit/s	5000ms is the shortest allowed H_IRT in data production mode H_TEST
7	H_CALIBRATION (via HS link)	A data set is generated only once (within ca. 274 sec) with 7 H_Image_Slice's + 2 H_Spectra (i.e. 7 x 12 SSLs + 2 Spectra = 7 x 12 x 19 + 2 x 7 TM packets = 1610 TM packets, not compressed)	< 45,6 kbit/sec (12497Kbit / 274 sec)	7 x HTM_PEM_HK + 2 x HTM_PEM_HK + HTM_ME_General_HK/10sec =  9 x 47words/274sec + 47words/10s + 16words/10s within 274 sec	< 125 bit/sec	
	H_CALIBRATION (via RTU link)	A data set is generated only once (within ca. 448 sec) with 7 H_Image_Slice's + 2 H_Spectra (i.e. 7 x 12 SSLs + 2 Spectra = 7 x 12 x 19 + 2 x 7 TM packets = 1610 TM packets, not compressed)	< 29,9 kbit/sec (12497Kbit / 448 sec)	7 x HTM_PEM_HK + 2 x HTM_PEM_HK + HTM_ME_General_HK/10sec =  9 x 47words/448sec + 47words/10s + 16words/10s within 448 sec	< 116 bit/sec	
8	H_NOMINAL_SIMULATION	depends on -H operational parameter, the max. data rate is generated every 64 x 700ms a H_Spectra_Slice not compressed, (i.e. 1 H_Spectra_Slice = 24 SSLs = 456 TM packets)	< 83,4 kbit/s (3735552 bit/44,8sec)	47words / 0,7s + 47words/10s + 16words/10s	< 1175 bit/sec	700ms is the shortest allowed H_IRT in data production mode H_NOMINAL_OSERVATION
9	H_SCIENCE_MAXIMUM_DATA_RATE	depends on -H operational parameter, the max. data rate is generated every 64 x 700ms a H_Spectra_Slice compressed or not compressed, (i.e. 1 H_Spectra_Slice = 24 SSLs = 456 TM packets) H_Spectrum_Dark are considered as negligible)	28 ... 87KBit/s	47words / 0,7s + 47words/10s + 16words/10s	< 1175 bit/sec	
10	H_SCIENCE_NOMINAL_DATA_RATE		3.5 ... 27KBit/s	(< 1175 bit/sec) / 87/27Kbit/sec	< 365 bit/sec	
11	H_SCIENCE_MINIMUM_DATA_RATE		< 3.4KBit/s	47words/10s + 16words/10s	< 101bit/sec	
13	H_SCIENCE_BACKUP	depends on -H operational parameter, the max. data rate is generated if a Image Slice is produced every 5s, not compressed, (i.e. 1 H_Image_Slice = 12 SSLs = 228 TM packets)	< 354KBit/s (if data rate is greater 354Kbit/s, TC_Enable_Science is not accepted to be commanded)	HTM_PEM_HK/IRT + HTM_PEM_HK/10sec + HTM_ME_General_HK/10sec = 47words/5s (min.IRT) + 47words/10s + 16words/10s	< 252Bit/s	5000ms is the shortest allowed H_IRT in data production mode H_SCIENCE_BACKUP
14	H_USER_DEFINED	see H_NOMINAL_SIMULATION	< 83,4 kbit/s	47words / 0,7s + 47words/10s + 16words/10s	< 1175 bit/sec	
18	H_SPECTRAL_CALIBRATION_SIMULATION	only one H_IMAGE_SLICE (simulated data)	-	-	-	
19	H_DEGRADED	see H_SCIENCE_*_DATA_RATE	< 83,4 kbit/s			Data are transferred by RTU link to S/C,TC_Enable_Science_RTU_Link
63	H_ME_TEST	depends on VTC_Enter_Test_Mode param.	0,03 ... 730KBit/s	(29+34)words/5s...300s	3...202Bit/s	Science data transferred by HS link

TAB. 6: V-H Operative Modes (Part 2)

Note **TAB. 6**(part 2)

- (1) Science data TM packet size = 512 words
- (2) Including TM packet header

2.2 Mode transition Diagrams

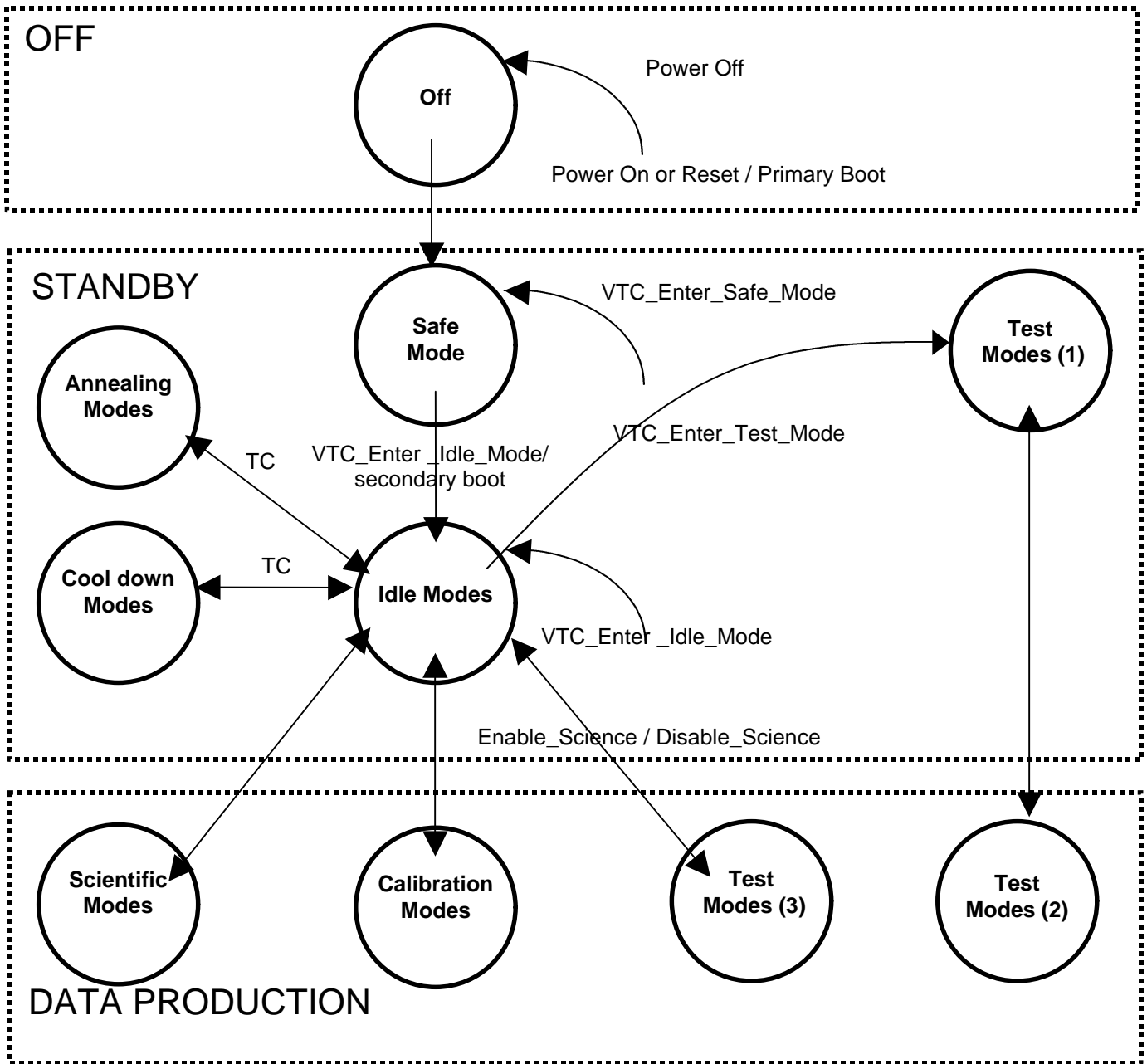
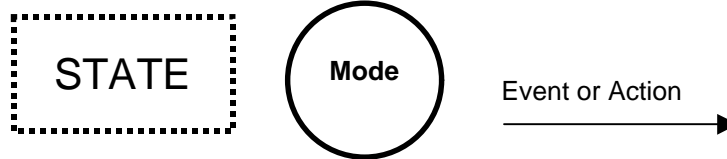

Fig. 2: VIRTIS Mode and State Transitions

**NOTES TO FIG. 2**

Graphic conventions:



- (1) This group contains only the ME test mode without data production:
  - Test(ME\_Test, H\_Off, M\_Off)
- (2) In this mode the ME produces test patterns on HS link with both PEMS off:
  - Test(ME\_Test, H\_ME\_Test, M\_ME\_Test)
- (3) This group contains V-H and V-M “transparent” modes with data production:
  - Test(ME\_Science, H\_Test, M\_Off)
  - Test(ME\_Science, H\_Off, M\_Test)
  - Test(ME\_Science, H\_Test, M\_Test)
- (4) If the Safe mode is active, the following TCs are accepted:

TC allowed in Safe mode	Function
TC_Enable_HK_Report_Generation (SID=1)	Enable generation of Default HK
TC_Disable_HK_Report_Generation (SID=1)	Disable generation of Default HK
TC_Load_Memory	Load patches/data in PM, DM, EEPROM or in Ports
TC_Dump_Memory	Dump memory patches/data from PM, DM, EEPROM or in Ports
TC_Check_Memory	Calculate checksum of memory areas in PM, DM, EEPROM
TC_Accept_Time_Update	Synchronize/set the ME internal timer by the S/C SCET
TC_Connection_Test_Request	Perform a MLC/SDT (TC/TM) connection test TM transfer
TC_Reset_TM_Output_Buffer	Reset (empty) the ME SDT and HW FIFO buffer
VTC_Enter_Safe_Mode	Reset of DPU after 30sec and perform Primary Boot as after power-on, enter Safe mode
VTC_Enter_Idle_Mode	Start secondary boot from EEPROM or from RAM
VTC_Failure_Override(CAT V)	Override of an internal software event/error recovery action
VTC_Failure_Deoverride(CAT V)	De-override of an internal software event/error recovery action
VTC_Confirm	Confirmation of critical TCs (only for VTC_Failure_Override)
VTC_Get_EEPROM_Status	Requests the EEPROM configuration status and sends an Event TM report to S/C

- (5) If the Idle mode is active, the following TCs are accepted:

TC allowed in ME Idle mode	Function
TC_Enable_HK_Report_Generation (SID=1,2,3,4,5,6 or ALL)	Enable generation of HK
TC_Disable_HK_Report_Generation (SID=1,2,3,4,5,6 or ALL)	Disable generation of HK
TC_Accept_Time_Update	Synchronize/set the ME internal timer by the S/C SCET
TC_Connection_Test_Request	Perform a MLC/SDT (TC/TM) connection test TM transfer
TC_Reset_TM_Output Buffer	Reset (empty) the ME SDT and HW FIFO buffer
VTC_Enter_Safe_Mode	Reset of DPU after 30sec, perform Primary Boot as after power-on
VTC_Enter_Idle_Mode	no action is performed, only a warning event 47510 is issued
VTC_Failure_Override	Override an internal software event/error recovery action
VTC_Failure_Deoverride	Restore of internal software event/error recovery action, which was overridden by the previous VTC_Failure_Override
VTC_Confirm	Confirmation of critical TCs
TC_Reset_SMCS_Chip	Reset the SMCS chip (1355 interfaces to S/C and test)
TC_Start_HS_link	Establishing/start of S/C 1355 HS link without reset
TC_Reset_And_Start_HS_Link	Reset the SMCS chip and start the HS link

TC allowed in ME Idle mode	Function
VTC_PEM(ON)	Switch-on the M-PEM and H-PEM
VTC_Cooler(ON, stand-by)	Switch-on the M-Cooler/CCE and H-Cooler/CCE
MTC_*	VIRTIS-M related TCs, Specific –M sub-system control function
HTC_*	VIRTIS-H related TCs, Specific –M sub-system control function

(6) If any data production mode is active, the following TCs are accepted:

TC allowed in a DP mode	Function
TC_Enable_HK_Report_Generation (SID=1,2,3,4,5,6 or ALL)	Enable generation of HK
TC_Disable_HK_Report_Generation (SID=1,2,3,4,5,6 or ALL)	Disable generation of HK
TC_Accept_Time_Update	Synchronize/set the ME internal timer by the S/C SCET
TC_Connection_Test_Request	Perform a MLC/SDT (TC/TM) connection test TM transfer
TC_Reset_TM_Output Buffer	Reset (empty) the ME SDT and HW FIFO buffer
VTC_Enter_Safe_Mode	Reset of DPU after 30sec, perform Primary Boot as after power-on
VTC_Enter_Idle_Mode	Switch-off of all –M and –H related hardware (e.g. coolers, PEMs, etc.), a warning event 47510 is issued
VTC_Failure_Override	Override of an internal software event/error recovery action
VTC_Failure_Deoverride	Deoverride of an internal software event/error recovery action
VTC_Confirm	Confirmation of critical TCs, (VTC_Failure_Override)
MTC_*	VIRTIS-M related TCs, Specific –M sub-system control function
HTC_*	VIRTIS-H related TCs, Specific –M sub-system control function



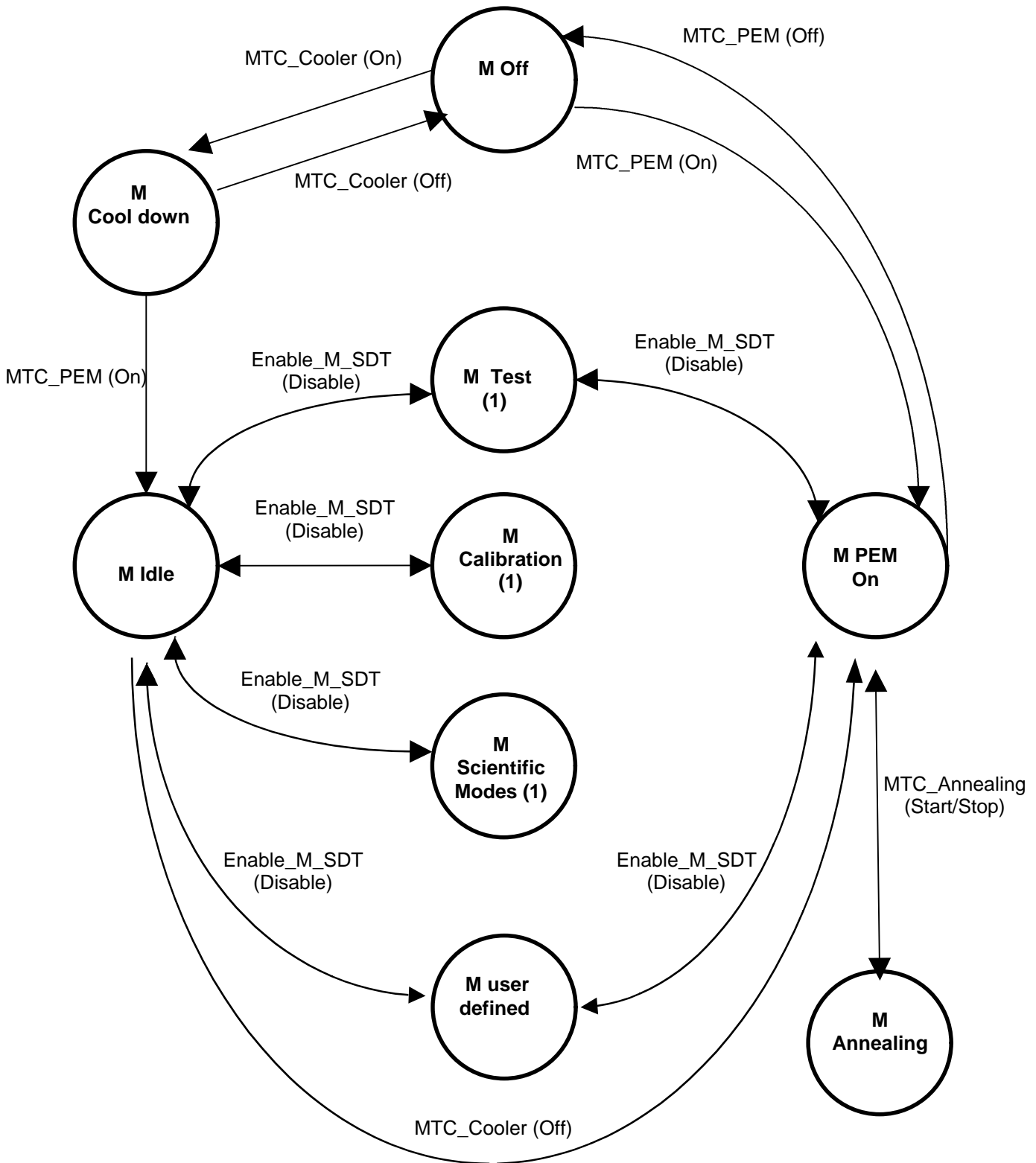

Fig. 3: V-M Mode Transitions



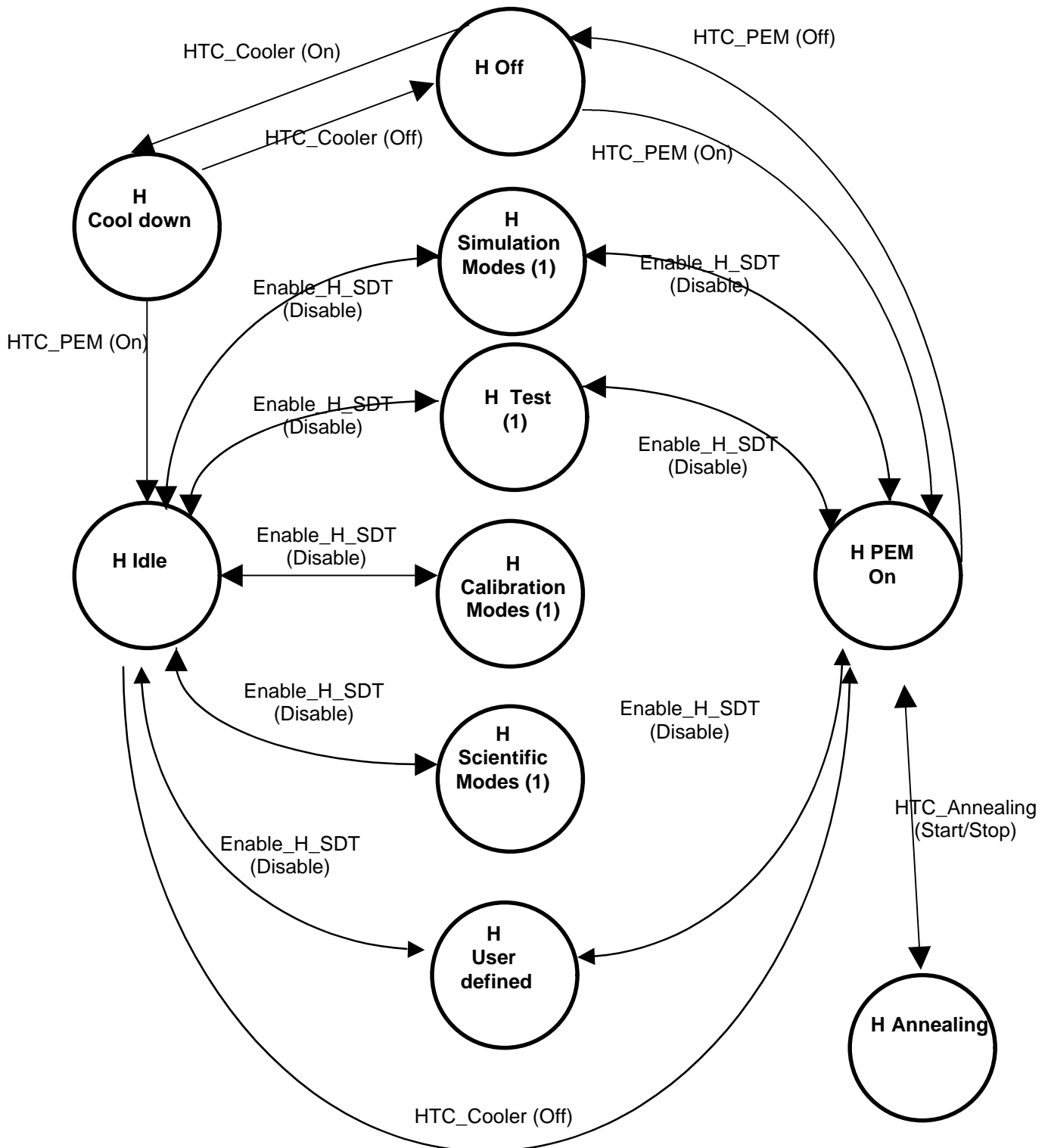

Fig. 4: V-H Mode Transitions



### 3 Packet Definitions

#### 3.1 Packet Service Compliance

The following packet services, as defined in EID-A 2.8, are supported by the VIRTIS instrument . TM reports which are solicited by a TC, are put on the left-hand column in the same row. Private TC packets are defined (according to the standard structure of the other TCs) only for functions that differ from the functions defined in the other services and contain one and only one TC function as defined in RD1.

Detailed information for each TC packet is reported in section 2.8.3.2.2.

Sub-type	Service Requests (TC)	Sub-type	Service Reports (TM)
<b>Service 1 - TC Acknowledge</b>			
		1	Acceptance Acknowledge-Success
		2	Acceptance Acknowledge-Failure
		7	Execution Acknowledge-Success
		8	Execution Acknowledge-Failure
<b>Service 3 - Housekeeping Reporting</b>			
5	Enable_HK_Report_Generation	25	H/K report for each SID
6	Disable_HK_Report_Generation		
<b>Service 5 - Event Reporting</b>			
		1	Normal progress report
		2	Anomalous Event Report
		3	Ground Action Event Report
		4	On -board Action Event Report
<b>Service 6 - Memory Management</b>			
2	Load_Memory		
5	Dump_Memory	6	Memory Dump Report
9	Check_Memory	10	Memory Check Report
<b>Service 9 -Time Management</b>			
1	Accept_Time_Update		
<b>Service 13 - Large Data Transfer</b>			
This service is not supported by the Instrument VIRTIS			
<b>Service 17 - Connection Test</b>			
1	Connection_Test_Request	2	Connection Test Report
<b>Service 18 - Context Transfer</b>			
This service is not supported by the Instrument VIRTIS			
<b>Service 19 - Information Distribution</b>			
This service is not supported by the Instrument VIRTIS			
<b>Service 20 - Science Reporting</b>			
1	Enable_Science_RTU_Link		
		3	Science Data (RTU link)
2	Disable_Science_RTU_Link		
10	Enable_Science_HS_Link		
		13	Science Data (HS link)
11	Disable_Science_HS_Link		
<b>Service 192 – VIRTIS Common Private TCs</b>			

Sub-type	Service Requests (TC)	Sub-type	Service Reports (TM)
1	VTC_Enter_Safe_Mode		
2	VTC_Enter_Idle_Mode		
3	VTC_Enter_Test_Mode		
4	VTC_PEMS		
5	VTC_Coolers		
10	VTC_Override		
11	VTC_Deoverride		
12	VTC_Confirm		
13	VTC_Get_EEPROM_Status		
<b>Service 193- VIRTIS-M Private TCs</b>			
1	MTC_PEM		
2	MTC_PEM_Command_Word		
3	MTC_Cover		
4	MTC_ECA		
5	MTC_Cooler		
6	MTC_Annealing		
10	MTC_Default_Configuration		
11	MTC_Change_Data_Product_Param_RAM		
12	MTC_Change_Data_Product_Param_RAM_EEPROM		
13	MTC_Change_Func_Param_RAM		
14	MTC_Change_Func_Param_RAM_EEPROM		
15	MTC_Change_Oper_Param_RAM		
16	MTC_Change_Oper_Param_RAM_EEPROM		
17	MTC_Change_Calibration_Param_RAM		
18	MTC_Change_Calibration_Param_RAM_EEPROM		
19	MTC_Change_Altern_Param_RAM		
20	MTC_Change_Altern_Param_RAM_EEPROM		
<b>Service 194 - VIRTIS-H Private TCs</b>			
1	HTC_PEM		
2	HTC_PEM_Command_Word		
3	HTC_Cover		
4	HTC_ECA		
5	HTC_Cooler		
6	HTC_Annealing		
10	HTC_Default_Configuration		
11	HTC_Change_Data_Product_Param_RAM		
12	HTC_Change_Data_Product_Param_RAM_EEPROM		
13	HTC_Change_Func_Param_RAM		
14	HTC_Change_Func_Param_RAM_EEPROM		
15	HTC_Change_Oper_Param_RAM		
16	HTC_Change_Oper_Param_RAM_EEPROM		

Sub-type	Service Requests (TC)	Sub-type	Service Reports (TM)
21	HTC_Change_Pixel_Map_Param_RAM		
22	HTC_Change_Pixel_Map_Param_RAM_EEP ROM		
26	HTC_Load_Pixel_Map		
27	HTC_Check_Pixel_Map		
<b>Service 255 – Common Payload Private TCs</b>			
1	Reset_Telemetry_Output Buffer		
2	Reset_SMCS_Chip		
3	Start_HS_Link		
4	Reset_And_Start_HS_Link		

TAB. 7: Packet Definitions

### 3.1.1 Telemetry Service Compliance

#### 3.1.1.1 Telemetry Concept

VIRTIS formats its output as TM source packets i.e. groups of 16 bit words serially transmitted by the instrument on the Serial 16 bit Digital channel and on the High Speed link (see Fig. 1). They are the Reports for the Services supported by the instrument (see RD1).

The main VIRTIS output are the scientific data from the three different data channels (M VIS, M IR and H). They are formatted in separate TM packets of the same Type and Sub-Type but with different Process IDs as different are the ground processing that are applied to Science Data. Other telemetry give the information about the operative status of the instrument in order to fully understand and characterize scientific data, as well as command the experiment correctly.

TM source packet format complies with par. 2.7.2.1 of RD1 and its main features are reported below in order to give the complete description of the structure.

#### 3.1.1.2 TM Packet Header

The Packet Header has the following structure (constant fields are shown shadowed):

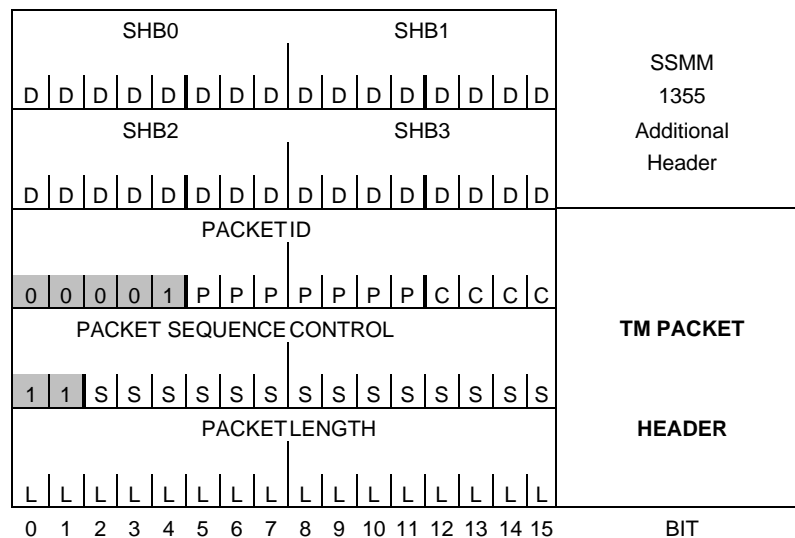

#### **DDDD DDDD DDDD DDDD**

The IEEE protocol between the Venus Express "High Speed" payloads and the SSMM requires the implementation of an additional header called "1C" before each TM from the High speed payloads to SSMM.

VIRTIS produce TM science both on high-speed link and Low speed link. This Additional header is present only for science packets produced to High speed link

For science TM on High speed link (service type 20 subtype 13):

SHB0=1C  
 SHB0=00  
 SHB0=00  
 SHB0=00

For science TM on RTU link (service type 20 subtype 3):

SHB0= not present  
 SHB0= not present  
 SHB0= not present  
 SHB0= not present



### PPP PPPP

Process ID:

- VIRTIS TM (all service except 20): 51;
- VIRTIS M science TM (service 20): 52;
- VIRTIS H scienceTM (service 20): 53.

It identifies in general terms the process generating the TM.

### CCCC

Packet Category (categories mapped to TM Service Types.

It identifies, for the same process, different categories of TM packets for which a different accounting is required to be kept.

NOTE: Process ID and Packet Category form the Application Process ID (APID) that uniquely identifies the on-board source of the packet (see [TAB. 1: VIRTIS Application Process Ids](#))

### SS SSSS SSSS SSSS

Source Sequence Count : a separate Source Sequence Counter is maintained for each different APID and is incremented by 1 whenever the source releases a packet; the counter starts at zero at power on and after a reset and wraps around from its maximum to zero.

### LLLL LLLL LLLL LLLL

Length of the packet (number of octets in the Packet Data Field minus one, i.e. 9 + number of octets in the Application Data Field); max = 1017 (Science data transfer on RTU link) ; for the Science Data transfer on the HS link, the value in this field complies with the requirements that the total Packet size shall consist of an even number of 16 bit words.

Due to the additional Header, the max value for science data transfer to HS link is lower (1013) than the max value for science data transfer on RTU link (1017).

### 3.1.1.3 TM Packet Data Field

Each Packet Data Field is composed of:

- Data Field Header
- Source Data

NOTE1: the PACKET ERROR CONTROL field is not used

The Data Field Header has the following structure (constant fields are shown shadowed) :

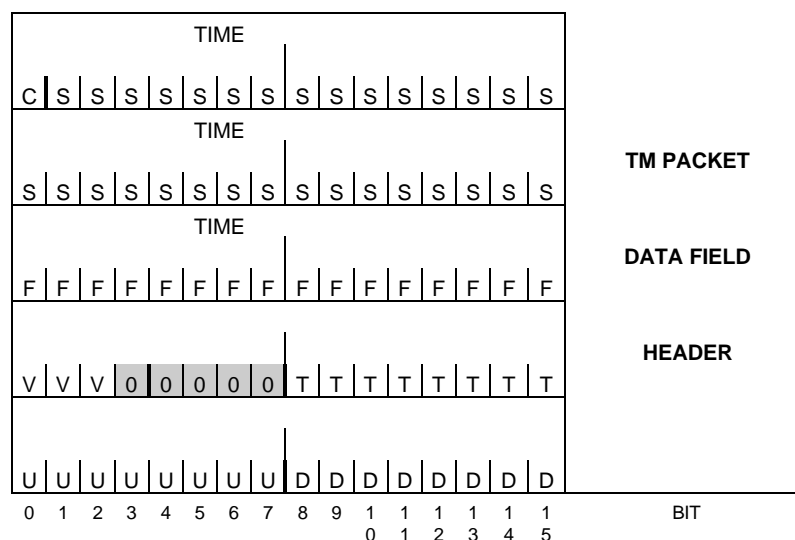

**C:**  
Synchronization flag:  
0=normal synchronization  
1=missing synchronization

**SSSS ..... SSSS**  
31 bits (unit Second) of the time the acquisition of the data in the packet was initiated

**FFFF FFFF**  
2 octets (unit Fractional second) of the time the acquisition of the data in the packet was initiated

**VVV**  
Packet Utilization Standard  
0=for Science TM services (20,3) and (20,13)  
1=for all other reports

**TTTT TTTT**  
Packet Service Type to which the TM source packet relates (see [TAB. 7: Packet Definitions](#))

**UUUU UUUU**  
Packet Service Sub-type to which the TM source packet relates(see [TAB. 7: Packet Definitions](#))

**DDDD DDDD**  
Pad field, always zero, unless the TM report is a solicited one (see Sect. 2.8.3.1). In this case it is a copy of the Pad field of the solicitant TC packet

The Source Data field structure is uniquely identified by the combination of APID, PACKET TYPE and PACKET SUB-TYPE and contains a whole number of 16-bit words

#### 3.1.1.4 TM Collection

TM packets are collected as follows:

- all data transfer to DMS are polled by the DMS
- DMS polls each unit at least once per 8 sec. but not more than once per 1 sec. (mean rate)
- each unit is polled at the max rate possible in a nominal 8 second cycle (within the above defined constraints)
- there is a minimum of 125 msec between the end of one block acquisition and the next poll
- the user formats TM data into source packets either to RTU or to SSMM
- RTU acquires TM sequentially from experiment to experiment on a single block basis (see below) : if the addressed experiment has packets available, they will be acquired, otherwise the acquisition proceeds to the next experiment
- the user complies with the TM Source Packet Acquisition protocol defined in 2.7.3.2. of RD1.
- as the RTU drives the acquisition, the user copes with a time interval between two consecutive 16 bit acquisition varying from 122  $\mu$ sec to 1 sec
- the user is able to buffer LS TM packets for 16 sec without data loss
- the S/C collects LS TM in blocks with the following features:
  - each block contains one or more whole packets
  - the max block length is 6144<sub>DEC</sub> word
  - the first word gives the number of 16 bit words following the block length (if no TM packets are available, the user puts zero in the first word of the block)
  - when polled, the user always returns at least the first word with the length of the available data block
  - at power on or reset the unit sets the TM block length to a zero value within 1 sec

- when the DMS detects an error in the TM packet structure it :
  - issues an Event Packet
  - stops acquisition from this terminal
  - discards the whole TM block or suspected data
  - issues the TC (255,1) “Reset TM Output buffer” (see 2.8.3.11.4 of RD1) to reset instrument TM at start of next block

High Rate Data are acquired as follows:

- the user complies with the Character Layer requirements defined in RD1
- the user complies with the Exchange Layer requirements defined in RD1 and in particular with the required bit and data rates
- the user complies with the Packet Layer requirements as defined in RD1; in particular :
  - the 1355 packet (see definition in IEEE 1355-1995 Standard, par.4.2.4.1) consists of one complete TM packet (as previously defined) delimited by the 1355 control character EPO1
  - the max 1355 packet length is 1024 bytes and is in any case multiple of 4
  - for the 16-bit words, the MOST significant byte is transmitted first while for each byte the LEAST significant bit is transmitted first
- the user complies with the Transaction Layer General Procedures defined in RD1; in particular:
  - upon reception of the RTU TC (255,2) the experiment resets its SMCS-HSL to SSMM
  - upon reception of the RTU TC (255,3) the experiment start/establish HSL to SSMM
  - upon reception of the RTU TC (255,4) the experiment resets SMCS and starts HSL to SSMM;
- the user complies with the High Rate Science Data Acquisition defined in RD1; the data transfer is performed under control of DMS via the RTU I/F using the packet services defined in RD1; in particular:
  - upon reception of the RTU TC (20,10) the experiment enables the Science Data transfer on the HS link
  - upon reception of the RTU TC (20,11) the experiment disables the Science Data transfer on the HS link
  - in case the transfer is stopped by the user, the experiment issues an Event TM “Science Data Transmission stopped at a packet boundary”

### 3.1.2 Telecommand Service Compliance

#### 3.1.2.1 Telecommand Concept

TC packets are groups of 16 bit words serially transmitted on the Memory Load Command channel (see

**Fig. 1:** ) according to the formats specified in the following sections. The specific instance of the TC packet is uniquely identified by the combination of the APID and sequence control fields, while the destination of the TC packet , i.e. the experiment, is indicated in its APID field and the functional meaning of the TC is given by the type and sub-type fields.

Each TC packet contains one and only operationally self-contained control action that may comprise or invoke one or more low-level control actions. Due to the influence on VIRTIS resources (power, data rate, SSMM usage), system requests (e.g. cover moving, mode change ...) will be initiated by the S/C. Operational sequences and time tagging are performed by the S/C and not by VIRTIS.

Each Service Request (TC packet from DMS to VIRTIS ) causes at least one Service Report (TM packet from VIRTIS to the S/C).

TC packet format complies with RD1 and its main features are reported below in order to give the complete description of the structure.

Each packet is composed of one Packet Header and one Packet Data Field .

### 3.1.2.2 TC Packet Header

Packet Header has the following structure (constant fields are shown shadowed):

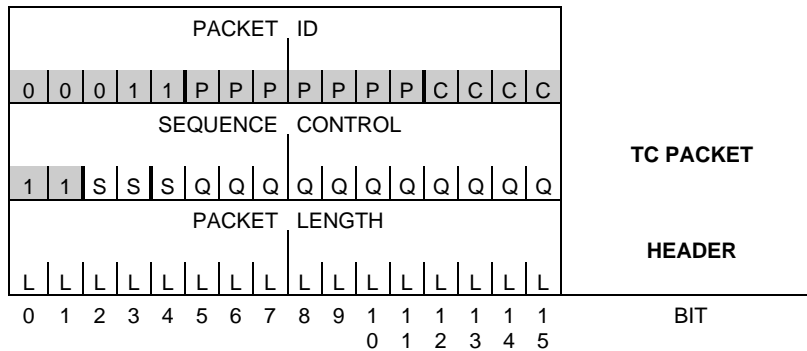

#### PPP PPPP

Process ID ; for VIRTIS TC : 51

#### CCCC

Packet Category; for TC : PRIVATE, i.e. "1100"

NOTE: the combination of Process ID and Packet Category forms the Application Process ID (APID) that uniquely identifies the destination of the TC packet (see [TAB. 1: VIRTIS Application Process Ids](#)).

#### SSS

Source Part of the Sequence Count field : identifies command source as follows :

- 000 = ground (all sources)
- 001 = Mission Time Line (DMS)
- 010 = DMS (all other sources)
- 011 = AOCS (N.A. for Payloads)
- 100 ... 111 = spare

#### QQQ QQQQ QQQQ

Sequence Part of the Sequence Count field : actual sequence number for that source

NOTE: the user is not required to check the Sequence Count field

#### LLLL LLLL LLLL LLLL

Length of the packet (number of octets in the Packet Data Field minus one, i.e. 5 + number of octets in the Application Data Field); max = (242-1)

NOTE: a specific instance of a TC packet is uniquely identified by the combination of the APID and Sequence Control field within the packet header.

### 3.1.2.3 TC Packet Data Field

Each Packet Data Field is composed of:

- Data Field Header (32 bits)
- Application Data
- Packet Error Control

The Data Field Header has the following structure (constant fields are shown shadowed) :

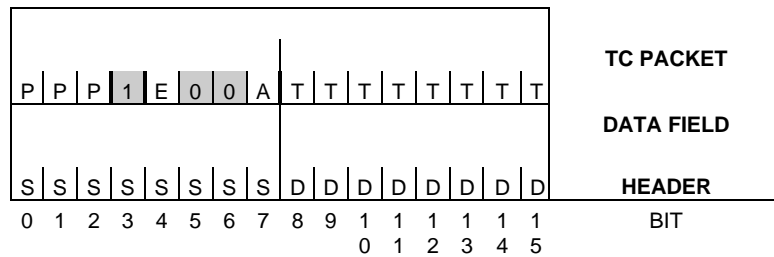

**PPP**

Packet Utilization Standard  
don't care for the experiment

**A**

Set to '1' to require acknowledgement of packet acceptance by application

**E**

Set to '1' to require acknowledgement of packet execution by application (valid only for XTC\_Cover, XTC\_ECA, XTC\_PEM and TC\_Disable\_Science\_HS\_Link)

**TTTT TTTT**

Packet Service Type

**SSSS SSSS**

Packet Service Sub-type

**DDDD DDDD**

Pad field that contains a routing token to be copied into the Pad field of solicited TM reports (see Sect. 2.8.3.1), otherwise to be ignored

NOTE: the functional meaning of the TC packet is identified by the Type and Sub-Type fields within the Data Field Header.

The Application Data field structure is uniquely identified by the combination of APID, PACKET TYPE and PACKET SUB-TYPE and is a multiple of 16-bit words.

The Packet Error Control field has the following structure :



NOTE: the user verifies the integrity of the TC packet using the error detection code in the PACKET ERROR CONTROL field; the specification of the checksum method selected (CRC checksum) is given in EID-C part 04.

**3.1.2.4 TC Distribution Protocol**

TC Packets are distributed as follows:

- all data transfer from DMS are polled by the DMS that will distribute TC packets via the Memory Load Command Channel
- the user receives TC formatted in packets from the RTU only
- the user decodes and checks each received TC packet
- the user copes with the maximum transfer rate defined in RD1 and buffers the packets accordingly
- if the user detects a time out or an error in the packet format, it :

- reflects this event in an Event Report TM packet (type=1)
- suspend TC processing for 16 sec (+10 %, -0%)
- flush its TC input buffer
- await next TC packet
- the user is able to receive TC packets sent as a number 'N' of non- contiguous interrogation blocks each containing 'n' MLC word (with  $1 \leq n \leq \text{TC packet length}$  and  $1 \leq N \leq \text{TC packet length}$ )
  - the user generates a time-out if the complete TC Packet is not transferred within 2 sec (+10 %, -0%)

## 3.2 Instrument Packet Definitions

### 3.2.1 Telemetry Packet Definitions

Detailed description of TM packets is given in this section. The information is formatted in compliance with RD8, part 4, section 2.8.3.2.1. The data types used for parameters are defined in RD8, part 4, section 3.

#### 3.2.1.1 Telecommand Verification Reporting TM

If an Acceptance Report is required by TC, the user generates it, indicating either success or failure of the checks performed prior to execute the TC, including verification of check of packet correctness (header, checksum, etc.) and consistency of the TC with the actual VIRTIS mode. The acknowledge is generated within 4 sec of receipt of the TC.

The TM acknowledge packet always includes both the TC Packet ID and the SEQUENCE CONTROL fields as identifier of the TC packet being acknowledged (see Appendix A).

TM- 1: (PID51, PC1, T1, ST1) Acceptance Success Report

Telemetry Packet Information (VIRTIS)			
Packet name	Acceptance Success Report	Instrument	VIRTIS
Packet Function	To acknowledge acceptance of aTC.		
Generation Rules	A TC has been received, checked and accepted.		
Header Information			
Process ID	51	Packet Category	1
Service Type	1	Service Subtype	1
Structure ID	N.A.	Packet Length	13
Data Field Information			
Data Field	Field Structure	Remarks	
TC Packet ID	Unsigned Integer 16 bits (PTC 3, PFC 12)	Packet ID of accepted TC	
TC Packet Sequence Control	Unsigned Integer 16 bits (PTC 3, PFC 12)	Packet Sequence Control of accepted TC	
<b>Notes:</b>			

TM- 2: (PID51, PC1, T1, ST7) Execution Success Report

Telemetry Packet Information (VIRTIS)			
Packet name	Execution Success Report	Instrument	VIRTIS
Packet Function	To acknowledge acceptance of aTC.		
Generation Rules	A TC (asking for such a report) has been successfully executed.		
Header Information			
Process ID	51	Packet Category	1
Service Type	1	Service Subtype	7
Structure ID	N.A.	Packet Length	13
Data Field Information			
Data Field	Field Structure	Remarks	
TC Packet ID	Unsigned Integer 16 bits (PTC 3, PFC 12)	Packet ID of accepted TC	
TC Packet Sequence Control	Unsigned Integer 16 bits (PTC 3, PFC 12)	Packet Sequence Control of accepted TC	
<b>Notes:</b> Foreseen only for the following commands: TC(20,11) Disable_Science_HS_Link TC(193,3) MTC_Cover TC(194,3) HTC_Cover TC(193,4) MTC_ECA TC(194,4) HTC_ECA TC (193,1) MTC_PEM TC (194,1) HTC_PEM TC (192, 4) VTC_PEMs			

## TM- 3: (PID51, PC1, T1, ST2) Acceptance Failure Report

Telemetry Packet Information (VIRTIS)						
Packet name	Acceptance Failure Report	Instrument	VIRTIS			
Packet Function	To inform that a TC has been rejected					
Generation Rules	A TC has been received, checked and rejected					
Header Information						
Process ID	51	Packet Category	1			
Service Type	1	Service Subtype	2			
Structure ID	N.A.	Packet Length	21 (or 17)			
Data Field Information						
Data Field	Field Structure	Remarks				
TC Packet ID	Unsigned Integer 16 bits (PTC 3, PFC 12)	Packet ID of rejected TC				
TC Packet Sequence Control	Unsigned Integer 16 bits (PTC 3, PFC 12)	Packet Sequence Control of rejected TC				
Failure Code	Enumerated Integer 16 bits (PTC 2, PFC 16)	see notes				
Packet Service Info	Unsigned Integer 16 bits (PTC 3, PFC 12)	Packet type (1 octet) and subtype (1 octet) of rejected TC				
Parameter 3	Unsigned Integer 16 bits (PTC 3, PFC 12)	see notes				
Parameter 4	Unsigned Integer 16 bits (PTC 3, PFC 12)	see notes				
Notes:						
Failure Code						
Failure Code	Parameter 1 8 bit	Parameter 2 8 bit	Parameter 3 16 bit	Parameter 4 16 bit		
1 (incomplete TC packet)	Packet type from received TC	Packet Subtype from received TC	Number of octets in the packet header * (1)	Number of octets actually received * (2)		
2 (Incorrect checksum)	Packet type from received TC	Packet Subtype from received TC	Received Checksum (from TC packet)	Expected Checksum (calculated)		
3 (Incorrect APID)	Packet type from received TC	Packet Subtype from received TC	not available in TM packet, i.e. in this case TM packet is shorter			
4 (Invalid TC code, Type/Subtype/TC length)	Packet type from received TC	Packet Subtype from received TC	0000hex	0000hex		
5 (TC cannot be accepted at this time)	Packet type from received TC	Packet Subtype from received TC	0000hex	0000hex		
6 (TC data field inconsistent)	Packet type from received TC	Packet Subtype from received TC	Word position (offset zero) of first field error	Erroneous Word Value Read		
7 (other Virtis specific failure)	Packet type from received TC	Packet Subtype from received TC		0000hex		
<p>* Note that number (1) and number (2) cannot be directly compared. (1) is a logical number of packet header and (2) is a physical number of octets which is really received when failure code is 7, parameter 3 has the following meaning:</p> <table style="width: 100%; border: none;"> <tr> <td style="width: 50%; vertical-align: top;">           0 = No additional information            1 = Unexpected value of acknowledgement field            2 = Invalid -M data rate            3 = Invalid mode transition            4 = -M External Repetition Time (M_ERT) too short (2)            5 = Invalid -M window size            6 = Confirmed a non critical TC         </td> <td style="width: 50%; vertical-align: top;">           7 = Confirmed a not received TC            8 = Cover TC after ECA actuation            9 = ME HS Link is not established            10 = M_ACQ_MODE not expected            11 = -H Internal Repetition Time (H-IRT) too short            12 = -H TM data rate too high         </td> </tr> </table>					0 = No additional information 1 = Unexpected value of acknowledgement field 2 = Invalid -M data rate 3 = Invalid mode transition 4 = -M External Repetition Time (M_ERT) too short (2) 5 = Invalid -M window size 6 = Confirmed a non critical TC	7 = Confirmed a not received TC 8 = Cover TC after ECA actuation 9 = ME HS Link is not established 10 = M_ACQ_MODE not expected 11 = -H Internal Repetition Time (H-IRT) too short 12 = -H TM data rate too high
0 = No additional information 1 = Unexpected value of acknowledgement field 2 = Invalid -M data rate 3 = Invalid mode transition 4 = -M External Repetition Time (M_ERT) too short (2) 5 = Invalid -M window size 6 = Confirmed a non critical TC	7 = Confirmed a not received TC 8 = Cover TC after ECA actuation 9 = ME HS Link is not established 10 = M_ACQ_MODE not expected 11 = -H Internal Repetition Time (H-IRT) too short 12 = -H TM data rate too high					



TM- 4: (PID51, PC1, T1, ST8) Execution Failure Report

Telemetry Packet Information (VIRTIS)			
Packet name	Execution Failure Report	Instrument	VIRTIS
Packet Function	To inform that a TC execution failed		
Generation Rules	A TC (asking for such a report) has been executed and failed.		
Header Information			
Process ID	51	Packet Category	1
Service Type	1	Service Subtype	8
Structure ID	N.A.	Packet Length	17
Data Field Information			
Data Field	Field Structure	Remarks	
TC Packet ID	Unsigned Integer 16 bits (PTC 3, PFC 12)	Packet ID of rejected TC	
TC Packet Sequence Control	Unsigned Integer 16 bits (PTC 3, PFC 12)	Packet Sequence Control of rejected TC	
Failure Code	Enumerated Integer 16 bits (PTC 2, PFC 16)	always 1 => the correct command status was not achieved	
Packet Service Info	Unsigned Integer 16 bits (PTC 3, PFC 12)	Packet type (1 octet) and subtype (1 octet) of rejected TC	
<b>Notes:</b> Foreseen only for the following commands:			
TC(20,11) Disable_Science_HS_Link			
TC(193,3) MTC_Cover			
TC(194,3) HTC_Cover			
TC(193,4) MTC_ECA			
TC(194,4) HTC_ECA			
TC (193,1) MTC_PEM			
TC (194,1) HTC_PEM			
TC (192, 4) VTC_PEMs			

### 3.2.1.2 H/K Data Reporting TMs

This service is used to transmit H/K data required both for monitoring the operational aspects of the instrument and for interpreting science data. The ME collects H/K data from the powered modules and generates HK Report TM packets at the rates indicated in **TAB. 8**.

Pre-defined sets of H/K parameters are transmitted according to the H/K Report Generation TCs in order to provide ground with all the required operational information. H/K parameters are self standing (i.e. not require data from other packets or TC history to be interpreted) and have the same structure and interpretation in all TM packets in which they appear.

H/K report types are defined according to the guidelines reported in RD 1 Specifically, each report type has its Structure Identification (SID) that is used on ground together with APID, Service Type and Sub-Type, to identify the report and its content. Reports can include:

- directly measured status information
- TC verification information other than that provided by the TC verification service
- unambiguous information as required for execution of configuration dependent TC
- a single parameter that unambiguously identifies the operating mode of the instrument

H/K reports are generated in a “periodic mode”. The “default” report is the “ME default H/K” report that contains the operating mode parameter. This report is enabled by default and therefore it is generated after power-on or reset, following the time synchronization or anyway after the 60 sec timeout if no time synchronization is received. After that, its generation can be disabled (and enabled again) using the commands sub-types T3,ST6 and T3,ST5 as for the other H/K reports

The ME generates two types of HK reports : beside the “default ” report (the only one transmitted during all modes including Safe) there a “ME/M general H/K” report (transmitted only when M-Cooler and/or M-ECA are ON) and a “ME/H general H/K” report (transmitted only when H-Cooler and/or H-ECA are ON).

Besides these, for each detector, one report containing all the H/K information generated by the PEM for that channel, is always transmitted when the PEM is powered, according to the period specified below.

NOTE : H/K data that are relevant to both the IR and VIS detector of VIRTIS-M are split on the two channels according to volume and mass optimization

The following table shows the H/K TM type definition on the VIRTIS instrument.

SID	H/K name	Generation rate	
		acquisition modes	other modes
1	ME Default H/K	periodically (10s) or (11s in Safe mode)	
2	ME/M general H/K	periodically (10s) (♣)	
3	ME/H general H/K	periodically (10s) (♠)	
4	M-VIS H/K	M-internal repetition rate	10 s (♦)
5	M-IR H/K	M-internal repetition rate	10 s (♦)
6	H-H/K	H-internal repetition rate	10 s (♥)

TAB. 8: H/K Report SID and Generation Definition

#### NOTES:

- (♣) only if M-Cooler and/or M-ECA are ON
- (♠) only if H-Cooler and/or H-ECA are ON
- (♦) only if M-PEM is ON
- (♥) only if H-PEM is ON

TM- 5: (PID51, PC4, T3, ST25, Sid1) ME Default H/K

Telemetry Packet Information (VIRTIS)			
Packet name	ME Default H/K	Instrument	VIRTIS
Packet Function	To provide Main Electronics housekeeping data		
Generation Rules	Periodic (every 10 s) when enabled		
Header Information			
Process ID	51	Packet Category	4
Service Type	3	Service Subtype	25
Structure ID	1	Packet Length	27
Data Field Information			
Data Field	Field Structure	Remarks	
SID	Enumerated Integer 16 bits (PTC 2, PFC 16)	value=1	
V_MODE	Unsigned Integer 16 bits (PTC 3, PFC 12)	VIRTIS Mode Id BIT 10..15 V-M Operative mode BIT 4..9 V-H Operative mode BIT 0..3 ME Operative mode (see NOTE for details)	
ME_PWR_STAT	Unsigned Integer 16 bits (PTC 3, PFC 12)	Power status word: BIT 15: -M power converter status (1/0 on/off) BIT 14: -H power converter status (1/0 on/off) BIT 13: -M IFE +5V power status (1/0 on/off) BIT 12: -H IFE +5V power status (1/0 on/off) BIT 11: ADC power status (1/0 on/off) BIT 10: EEPROM +5V power status (1/0 on/off) BIT 1..9: always 0 BIT 0: DPU_ID (1= redundant, 0= Main)	
ME_PS_TEMP	Unsigned Integer 16 bits (PTC 3, PFC 12)	BIT 4..15:Power Supply temperature (0.244K/bit) Operational limits: 233K-343K BIT 0..3 = always 0	
ME_DPU_TEMP	Unsigned Integer 16 bits (PTC 3, PFC 12)	BIT 4..15:DPU temperature (0.244K/bit) Operational limits: 233K-343K BIT 0..3 = always 0	
ME_DHSU_VOLT	Unsigned Integer 16 bits (PTC 3, PFC 12)	BIT 4..15:DHSU voltage (0.002442 V/bit) Operational limits: 4.75V-5.25V BIT 3..0 = always 0	
ME_DHSU_CURR	Unsigned Integer 16 bits (PTC 3, PFC 12)	BIT 4..15:DHSU current (0.002442 A/bit) Operational limits: 0.300A-1.2A BIT 0..3 = always 0	
IFE_ELECTR_VOLT	Unsigned Integer 16 bits (PTC 3, PFC 12)	BIT 4..15: - If Main DPU is actives=M-IFE voltage (0.002442 V/bit) - If Redundant DPU is actives=H-IFE voltage (0.002442 V/bit) Operational limits: <ul style="list-style-type: none"> <li>• -0.1V to +0.1V</li> <li>• if ME_PWR_STAT (M IFE +5V power status =1 ON) and (DPU_ID = Main) then 4.75V-5.25V</li> <li>• if ME_PWR_STAT (H IFE +5V power status =1 ON) and (DPU_ID = Redundant) then 4.75V-5.25V</li> </ul> BIT 0..3 = always 0	

EEPROM_VOLT	Unsigned Integer 16 bits (PTC 3, PFC 12)	BIT 4..15:EEprom voltage (0.002442 V/bit) Operational limits: <ul style="list-style-type: none"> <li>-0.1V to +0.1V</li> <li>if EEPROM +5V power status = 1 (ON) then 4.75V-5.25V</li> </ul> BIT 0..3 = always 0
-------------	--	---

**Notes:**

ME Operative Mode				V-H Operative Mode						V-M Operative Mode					
b <sub>0</sub>	b <sub>1</sub>	b <sub>2</sub>	b <sub>3</sub>	b <sub>4</sub>	b <sub>5</sub>	b <sub>6</sub>	b <sub>7</sub>	b <sub>8</sub>	b <sub>9</sub>	b <sub>10</sub>	b <sub>11</sub>	b <sub>12</sub>	b <sub>13</sub>	b <sub>14</sub>	b <sub>15</sub>
1 ME_Off				1 H_Off						1 M_Off					
2 ME_Safe				2 H_Cool_Down						2 M_Cool_Down					
3 ME_Development				3 H_Idle						3 M_Idle					
4 ME_Idle				4 H_Annealing						4 M_Annealing					
5 ME_Science				5 H_PEM_On						5 M_PEM_On					
6 ME_Test				6 H_Test						6 M_Test					
				7 H_Calibration						7 M_Calibration					
				8 H_Nominal_Simulation						8 M_Science_High_Spectral_1					
				9 H_Science_Maximum_Data_Rate						9 M_Science_High_Spectral_2					
				10 H_Science_Nominal_Data_Rate						10 M_Science_High_Spectral_3					
				11 H_Science_Minimum_Data_Rate						11 M_Science_High_Spatial_1					
				12 DELETED						12 M_Science_High_Spatial_2					
				13 H_Science_Backup						13 M_Science_High_Spatial_3					
				14 H_User_Defined						14 M_Science_Nominal_1					
				15 DELETED						15 M_Science_Nominal_2					
				16 DELETED						16 M_Science_Nominal_3					
				17 DELETED						17 M_Science_Nominal_Compressed					
				18 H_Spectral_Calibration_Simulation						18 M_Science_Reduced_Slit					
				19: H_Degraded (**)						19 M_User_Defined					
										20: M_Degraded (**)					
				63 H_ME_Test (*)						63 M_ME_Test (*)					

TM- 6: (PID51, PC4, T3, ST25, Sid2) ME/M General H/K

Telemetry Packet Information (VIRTIS)			
Packet name	ME/M General H/K	Instrument	VIRTIS
Packet Function	To provide general housekeeping data for M-Cooler and M-ECA		
Generation Rules	Periodic (every 10 s) when enabled		
Header Information			
Process ID	51	Packet Category	4
Service Type	3	Service Subtype	25
Structure ID	2	Packet Length	25
Data Field Information			
Data Field	Field Structure	Remarks	
SID	Enumerated Integer 16 bits (PTC 2, PFC 16)	value=2	
M_ECA_STAT	Unsigned Integer 16 bits (PTC 3, PFC 12)	BIT 15: -M ECA status (1/0 open/closed) BIT 8..14: always 0 BIT 7: -M ECA power (1/0 on/off) BIT 0..6: always 0	
M_COOL_STAT	Unsigned Integer 16 bits (PTC 3, PFC 12)	BIT 15: -M cooler mode (1=open loop, 0=closed loop) BIT 12..14: always 0 BIT 11: -M cooler motor drv status (1/0 on/off) BIT 8..10: always 0 BIT 7: -M CCE +28V power (1/0 on/off) BIT 0..6: always 0	
M_COOL_TIP_TEMP	Unsigned Integer 16 bits (PTC 3, PFC 12)	BIT 4..15: -M cooler cold tip temperature ( $9.768 \cdot 10^{-3}$ K/Bit +60K) Operational limits: 60K-100K BIT 0..3 = always 0	
M_COOL_MOT_VOLT	Unsigned Integer 16 bits (PTC 3, PFC 12)	BIT 4..15: -M cooler motor voltage (0.004884 V/Bit) Operational limits: <ul style="list-style-type: none"> <li>-0.1V to +0.1V</li> <li>if M_COOL_STAT bit 11 (motor driver status) = 1(ON) then 2V to 15V</li> </ul> BIT 0..3 = always 0	
M_COOL_MOT_CURR	Unsigned Integer 16 bits (PTC 3, PFC 12)	BIT 15..4: -M cooler motor current (0.0004884 A/Bit) operational limits: <ul style="list-style-type: none"> <li>-0.01A to +0.01A</li> <li>if M_COOL_STAT bit 11 (motor driver status) = 1(ON) then 0.3A to 1.1A</li> </ul> BIT 3..0 = always 0	
M_CCE_SEC_VOLT	Unsigned Integer 16 bits (PTC 3, PFC 12)	BIT 4..15: -M CCE secondary voltage (0.004884 V/Bit) operational limits: <ul style="list-style-type: none"> <li>-0.1V to +0.1V</li> <li>if M_COOL_STAT bit 7 (CCE power status) = 1(ON) then 14.25V to 15.75V</li> </ul> BIT 0..3 = always 0	
M_SCIENCE_TM_PACKET_COUNTER	Unsigned Integer 16 bits (PTC 3, PFC 12)	Number of Science TM packets generated (start at 0x0000 after each TC_Enable_Science)	
Notes:			

TM- 7: (PID51, PC4, T3, ST25, Sid3) ME/H General H/K

Telemetry Packet Information (VIRTIS)			
Packet name	ME/H General H/K	Instrument	VIRTIS
Packet Function	To provide general housekeeping data for H-Cooler and H-ECA		
Generation Rules	Periodic (every 10 s) when enabled		
Header Information			
Process ID	51	Packet Category	4
Service Type	3	Service Subtype	25
Structure ID	3	Packet Length	25
Data Field Information			
Data Field	Field Structure	Remarks	
SID	Enumerated Integer 16 bits (PTC 2, PFC 16)	value=3	
H_ECA_STAT	Unsigned Integer 16 bits (PTC 3, PFC 12)	BIT 15: -H ECA status (1/0 open/closed) BIT 8..14: always 0 BIT 7: -H ECA power (1/0 on/off) BIT 0..6: always 0	
H_COOL_STAT	Unsigned Integer 16 bits (PTC 3, PFC 12)	BIT 15: -H cooler mode (1=open loop, 0=closed loop) BIT 12..14: always 0 BIT 11: -H cooler motor drv status (1/0 on/off) BIT 8..10: always 0 BIT 7: -H CCE +28V power (1/0 on/off) BIT 0..6: always 0	
H_COOL_TIP_TEMP	Unsigned Integer 16 bits (PTC 3, PFC 12)	BIT 4..15: -H cooler cold tip temperature ( $9.768 \times 10^{-3}$ K/Bit +60K) Operational limits: 60K-100K BIT 0..3 = always 0	
H_COOL_MOT_VOLT	Unsigned Integer 16 bits (PTC 3, PFC 12)	BIT 4..15: -H cooler motor voltage (0.004884 V/Bit) Operational limits: <ul style="list-style-type: none"> <li>-0.1V to +0.1V</li> <li>if H_COOL_STAT bit 11 (motor driver status) = 1(ON) then 2V to 15V</li> </ul> BIT 0..3 = always 0	
H_COOL_MOT_CURR	Unsigned Integer 16 bits (PTC 3, PFC 12)	BIT 4..15: -H cooler motor current (0.0004884 A/Bit) operational limits: <ul style="list-style-type: none"> <li>-0.01A to +0.01A</li> <li>if H_COOL_STAT bit 11 (motor driver status) = 1(ON) then 0.3A to 1.1A</li> </ul> BIT 0..3 = always 0	
H_CCE_SEC_VOLT	Unsigned Integer 16 bits (PTC 3, PFC 12)	BIT 4..15: -H CCE secondary voltage (0.004884 V/Bit) operational limits: <ul style="list-style-type: none"> <li>-0.1V to +0.1V</li> <li>if H_COOL_STAT bit 7 (CCE power status) = 1(ON) then 14.25V to 15.75V</li> </ul> BIT 0..3 = always 0	
H_SCIENCE_TM_PACKET_COUNTER	Unsigned Integer 16 bits (PTC 3, PFC 12)	Number of Science TM packets generated (start at 0x0000 after each TC_Enable_Science)	
<b>Notes:</b>			

TM- 8: (PID51, PC4, T3, ST25, Sid4) M-VIS H/K

Telemetry Packet Information (VIRTIS)			
Packet name	M-VIS H/K	Instrument	VIRTIS
Packet Function	To provide housekeeping data for VIRTIS-M VIS channel		
Generation Rules	Periodic when enabled and PEM-M is on: - every 10 s when no science data production is performed - at internal PEM-M repetition rate during science data production		
Header Information			
Process ID	51	Packet Category	4
Service Type	3	Service Subtype	25
Structure ID	4	Packet Length	61
Data Field Information			
Data Field	Field Structure	Remarks	
SID	Enumerated Integer 16 bits (PTC 2, PFC 16)	BIT 13..15: value=4 BIT 0..12: always 0	
M_CCD_VDR_HK	Unsigned Integer 16 bits (PTC 3, PFC 12)	CCD Vdr bias voltage $a_d = 7.554E-04$ $b_d = -2.475E+01$ unit=Volt Operational limits: 12.6V to 13,2V	
M_CCD_VDD_HK	Unsigned Integer 16 bits (PTC 3, PFC 12)	CCD Vdd bias voltage $a_d = 1.231E-03$ $b_d = -4.032E+01$ unit=Volt Operational limits: 16.3V to 16.9V	
M_+5_VOLT	Unsigned Integer 16 bits (PTC 3, PFC 12)	+5 power supply voltage $a_d = 3.080E-04$ $b_d = -1.009E+01$ unit=Volt Operational limits: 4.75V to 5.25V	
M_+12_VOLT	Unsigned Integer 16 bits (PTC 3, PFC 12)	+12 power supply voltage $a_d = 6.165E-04$ $b_d = -2.020E+01$ unit=Volt Operational limits: 11.4V to 12.6V	
M_-12_VOLT	Unsigned Integer 16 bits (PTC 3, PFC 12)	-12 power supply voltage $a_d = 6.178E-04$ $b_d = -2.024E+01$ unit=Volt Operational limits: -12.6V to -11.4V	
M_+20_VOLT	Unsigned Integer 16 bits (PTC 3, PFC 12)	+20 power supply voltage $a_d = 1.231E-03$ $b_d = -4.032E+01$ unit=Volt Operational limits: 19V to 21V	
M_+21_VOLT	Unsigned Integer 16 bits (PTC 3, PFC 12)	+21 power supply voltage $a_d = 1.226E-03$ $b_d = -4.016E+01$ unit=Volt Operational limits: 20V to 24V	
M_CCD_LAMP_VOLT	Unsigned Integer 16 bits (PTC 3, PFC 12)	CCD Calibration lamp voltage $a_d = 7.668E-04$ $b_d = -2.513E+01$ unit=Volt Operational limits: <ul style="list-style-type: none"> <li>• -0.1V to +0.1V</li> <li>• if M_VIS_FLAG_ST bit 7 (last command to lamp) = 1(ON) then 11V to 16V</li> </ul>	
M_CCD_TEMP_OFFSET	Unsigned Integer 16 bits (PTC 3, PFC 12)	Voltage offset in CCD temperature measurement chain $a_d = 1.527E-04$ $b_d = -5.005E+00$ unit=Volt Operational limits : -0.01V to +0.01V	
M_CCD_TEMP	Unsigned Integer 16 bits (PTC 3, PFC 12)	CCD temperature $a_d = 3.052E-02$ $b_d = -1.000E+03$ unit=ohm (Kelvin nota 1) Operational limits: 140K to 190K	
M_CCD_TEMP_RES	Unsigned Integer 16 bits (PTC 3, PFC 12)	Current flow in CCD temperature sensor $a_d = 1.527E-06$ $b_d = -5.005E-02$ unit=A Operational limits: 0.004A to 0.006A	



M_RADIATOR_TEMP	Unsigned Integer 16 bits (PTC 3, PFC 12)	OM Radiator temperature $a_d= 3.052E-02$ $b_d=-1.000E+03$ unit= ohm (Kelvin nota 1) Operational limits: 120K to 160K
M_LEDGE_TEMP	Unsigned Integer 16 bits (PTC 3, PFC 12)	OM Ledge temperature $a_d= 3.052E-02$ $b_d=-1.000E+03$ unit= ohm (Kelvin nota 1) Operational limits: 130K to 160K
OM_BASE_TEMP	Unsigned Integer 16 bits (PTC 3, PFC 12)	OM Baseplate temperature $a_d= 3.052E-02$ $b_d=-1.000E+03$ unit= ohm (Kelvin nota 1) Operational limits: 233K to 333K
H_COOLER_TEMP	Unsigned Integer 16 bits (PTC 3, PFC 12)	H-Cooler temperature $a_d= 3.052E-02$ $b_d=-1.000E+03$ unit= ohm (Kelvin nota 1) Operational limits: 233K to 333K
M_COOLER_TEMP	Unsigned Integer 16 bits (PTC 3, PFC 12)	M-Cooler temperature $a_d= 3.052E-02$ $b_d=-1.000E+03$ unit= ohm (Kelvin nota 1) Operational limits: 233K to 333K
M_CCD_WIN_X1	Unsigned Integer 16 bits (PTC 3, PFC 12)	BIT 6..15: X coordinate of first pixel of CCD window $a_d= 1$ $b_d=0$ unit=pixel BIT 0..5 = always 0
M_CCD_WIN_Y1	Unsigned Integer 16 bits (PTC 3, PFC 12)	BIT 7..15: Y coordinate of first pixel of CCD window $a_d= 1$ $b_d=0$ unit=pixel BIT 0..6 = always 0
M_CCD_WIN_X2	Unsigned Integer 16 bits (PTC 3, PFC 12)	BIT 6..15: X coordinate of last pixel of CCD window $a_d= 1$ $b_d=0$ unit=pixel BIT 0..5 = always 0
M_CCD_WIN_Y2	Unsigned Integer 16 bits (PTC 3, PFC 12)	BIT 7..15: Y coordinate of last pixel of CCD window $a_d= 1$ $b_d=0$ unit=pixel BIT 0..6 = always 0
M_CCD_DELAY	Unsigned Integer 16 bits (PTC 3, PFC 12)	BIT 6..15: CCD integration delay (EM) $a_d= 1.0E-01$ $b_d=0$ unit=sec (FM) $a_d= 2.0E-02$ $b_d=0$ unit=sec BIT 0..5 = always 0
M_CCD_EXPO	Unsigned Integer 16 bits (PTC 3, PFC 12)	BIT 6..15: CCD integration time (EM) $a_d= 1.0E-01$ $b_d=0$ unit=sec (FM) $a_d= 2.0E-02$ $b_d=0$ unit=sec BIT 0..5 = always 0
M_MIRROR_SIN_HK	Unsigned Integer 16 bits (PTC 3, PFC 12)	BIT 4..15: Commanded sin of mirror electrical angle $a_d= 2.442E-04$ $b_d=0$ unit= BIT 3: sign (0=positive sin 1=negativ sin) BIT 0..2 = always 0
M_MIRROR_COS_HK	Unsigned Integer 16 bits (PTC 3, PFC 12)	BIT 4..15: Commanded cos of mirror electrical angle $a_d= 2.442E-04$ $b_d=0$ unit= BIT 0..3 = always 0
M_VIS_FLAG_ST	Unsigned Integer 16 bits (PTC 3, PFC 12)	VIS status and scan flags: BIT 15: CCD scan flag (0=not performed 1=performed) BIT 14: H/K acquisition flag (0=not performed 1=performed) BIT 13: time error flag (0=no-error 1=command received out of the idle time) BIT 12: word error flag (0=no-error 1=wrong command received) BIT 11: VIS checkout ADC latch-up status (0=no- latchup 1=latchup during acquisition) BIT 8..10: always 0 BIT 7: last command to CCD calibration lamp (0=off 1=on) BIT 0..6: always 0



**Notes:** The  $a_d$  and  $b_d$  coefficients are referred to the following transfer function

$$TF: Y = a_d * X_{ADU} + b_d$$

(Note 1): To convert the PT500 resistance value to Kelvin unit, refer to the following Rosemount resistance-temperature table.

Temperature (Kelvin)	Resistance (Ohm)	Temperature (Kelvin)	Resistance (Ohm)
673.15	1244.49	333.15	617.39
653.15	1209.37	313.15	578.49
633.15	1174.03	293.15	539.36
613.15	1138.47	273.15	500
593.15	1102.68	253.15	460.31
573.15	1066.68	233.15	420.33
553.15	1030.46	213.15	380.03
533.15	994.01	193.15	339.41
513.15	957.34	173.15	298.43
493.15	920.46	153.15	257.03
473.15	883.36	133.15	215.14
453.15	846.03	113.15	172.64
433.15	808.48	93.15	129.5
413.15	770.71	73.15	86.1
393.15	732.72	53.15	44.62
373.15	694.5	33.15	12.67
353.15	656.05	13.15	1.25

TM- 9: (PID51, PC4, T3, ST25, Sid5) M-IR H/K

Telemetry Packet Information (VIRTIS)			
Packet name	M-IR H/K	Instrument	VIRTIS
Packet Function	To provide housekeeping data for VIRTIS-M IR channel		
Generation Rules	Periodic when enabled and PEM-M is on: - every 10 s when no science data production is performed - at internal PEM-M repetition rate during science data production		
Header Information			
Process ID	51	Packet Category	4
Service Type	3	Service Subtype	25
Structure ID	5	Packet Length	51
Data Field Information			
Data Field	Field Structure	Remarks	
SID	Enumerated Integer 16 bits (PTC 2, PFC 16)	BIT 13..15 = value=5 BIT 0..12 = always 0	
M_IR_VDETCOM_HK	Unsigned Integer 16 bits (PTC 3, PFC 12)	IR VDETCOM bias voltage $a_d = 3.052E-04$ $b_d = -9.994$ unit=Volt Operational limits: <ul style="list-style-type: none"> <li>-0.01V to +0.01V</li> <li>if M_IR_FLAG_ST bit 10 (IR detector status) = 1(ON) then 3.18V to 3.22V</li> </ul>	
M_IR_VDETADJ_HK	Unsigned Integer 16 bits (PTC 3, PFC 12)	IR VDETADJ bias voltage $a_d = 3.061E-04$ $b_d = -1.003E+01$ unit=Volt Operational limits: <ul style="list-style-type: none"> <li>-0.01V to +0.01V</li> <li>if M_IR_FLAG_ST bit 10 (IR detector status) = 1(ON) then 2.67V to 2.73V</li> </ul>	
M_IR_VPOS	Unsigned Integer 16 bits (PTC 3, PFC 12)	IR VPOS supply voltage $a_d = 3.058E-04$ $b_d = -1.002E+01$ unit=Volt Operational limits: <ul style="list-style-type: none"> <li>-0.01V to +0.01V</li> <li>if M_IR_FLAG_ST bit 10 (IR detector status) = 1(ON) then 4.75V to 5.25V</li> </ul>	
M_IR_VDP	Unsigned Integer 16 bits (PTC 3, PFC 12)	IR VDP supply voltage $a_d = 3.058E-04$ $b_d = -1.002E+01$ unit=Volt Operational limits: <ul style="list-style-type: none"> <li>-0.01V to +0.01V</li> <li>if M_IR_FLAG_ST bit 10 (IR detector status) = 1(ON) then 4.75V to 5.25V</li> </ul>	
M_IR_TEMP_OFFSET	Unsigned Integer 16 bits (PTC 3, PFC 12)	Voltage offset in IR temperature measurement chain $a_d = 1.527E-04$ $b_d = -5.005E+00$ unit=Volt Operational limits : -0.01V to +0.01V	
M_IR_TEMP	Unsigned Integer 16 bits (PTC 3, PFC 12)	IRFPA temperature $a_d = 6.128E-05$ $b_d = -2.008E+00$ unit=Volt (Kelvin nota 1) Operational limits: <ul style="list-style-type: none"> <li>65K to +313K</li> <li>if M_IR_FLAG_ST bit 10 (IR detector status) = 1(ON) then 75K to 100K</li> </ul>	
M_IR_TEMP_RES	Unsigned Integer 16 bits (PTC 3, PFC 12)	Current flow in IR temperature sensor $a_d = 7.645E-07$ $b_d = -2.505E-02$ unit= A Operational limits : 0.004A to 0.006A	
M_SHUTTER_TEMP	Unsigned Integer 16 bits (PTC 3, PFC 12)	Shutter temperature $a_d = 3.055E-02$ $b_d = -1.001E+03$ unit=ohm (Kelvin nota 2) Operational limits :130K to 160K	

M_GRATING_TEMP	Unsigned Integer 16 bits (PTC 3, PFC 12)	Grating temperature $a_d = 3.055E-02$ $b_d = -1.001E+03$ unit=ohm (Kelvin nota 2) Operational limits :130K to 160K
M_SPECT_TEMP	Unsigned Integer 16 bits (PTC 3, PFC 12)	Spectrometer temperature $a_d = 3.055E-02$ $b_d = -1.001E+03$ unit=ohm (Kelvin nota 2) Operational limits :130K to 160K
M_TELE_TEMP	Unsigned Integer 16 bits (PTC 3, PFC 12)	Telescope temperature $a_d = 3.055E-02$ $b_d = -1.001E+03$ unit=ohm (Kelvin nota 2) Operational limits :130K to 160K
M_SU_MOTOR_TEMP	Unsigned Integer 16 bits (PTC 3, PFC 12)	Scan unit motor temperature $a_d = 3.055E-02$ $b_d = -1.001E+03$ unit=ohm (Kelvin nota 2) Operational limits :130K to 160K
M_IR_LAMP_VOLT	Unsigned Integer 16 bits (PTC 3, PFC 12)	IR Calibration lamp voltage $a_d = 7.649E-04$ $b_d = -2.506E+01$ unit=Volt Operational limits: <ul style="list-style-type: none"> <li>-0.1V to +0.1V</li> <li>if M_IR_LAMP_SHUTTER bit 11 (last CM to lamp) = 1(ON) then 2V to 2.6V</li> </ul>
M_SU_MOTOR_CURR	Unsigned Integer 16 bits (PTC 3, PFC 12)	Scan unit motor current (EM) $a_d = 1.5305E-06$ $b_d = -5.0151E-02$ unit=A (FM) $a_d = 6.113E-06$ $b_d = -2.003E-01$ unit=A Operational limits: -0.050A to +0.050A
M_IR_WIN_Y1	Unsigned Integer 16 bits (PTC 3, PFC 12)	BIT 7..15: Y coordinate of first pixel of IR window $a_d = 1$ $b_d = 0$ unit=pixel BIT 0..6 = always 0
M_IR_WIN_Y2	Unsigned Integer 16 bits (PTC 3, PFC 12)	BIT 7..15: Y coordinate of last pixel of IR window $a_d = 1$ $b_d = 0$ unit=pixel BIT 0..6 = always 0
M_IR_DELAY	Unsigned Integer 16 bits (PTC 3, PFC 12)	BIT 6..15: IR integration delay (EM) $a_d = 1.0E-01$ $b_d = 0$ unit=sec (FM) $a_d = 2.0E-02$ $b_d = 0$ unit=sec BIT 0..5 = always 0
M_IR_EXPO	Unsigned Integer 16 bits (PTC 3, PFC 12)	BIT 6..15: IR integration time (EM) $a_d = 1.0E-01$ $b_d = 0$ unit=sec (FM) $a_d = 2.0E-02$ $b_d = 0$ unit=sec BIT 0..5 = always 0
M_IR_LAMP_SHUTTER	Unsigned Integer 16 bits (PTC 3, PFC 12)	IR lamp shutter BIT 12..15: last current value of IR calib. lamp (EM) $a_d = 1$ $b_d = 1.94E+02$ unit=mA (FM) $a_d = 1$ $b_d = 9.4E+01$ unit=mA BIT 11: last command to IR calib. Lamp (0=off 1=on) BIT 8..10: always 0 BIT 4..7: last current value of shutter (EM) $a_d = 1$ $b_d = 4.1E+01$ unit=mA (FM) $a_d = 1$ $b_d = 4.5E+01$ unit=mA BIT 3: last command to shutter (0=off 1=on) BIT 0..2: always 0

M_IR_FLAG_ST	Unsigned Integer 16 bits (PTC 3, PFC 12)	IR status and scan flags BIT 15: IRFPA scan flag (0=not performed 1=performed) BIT 14: H/K acquisition flag (0=not performed 1=performed) BIT 13: time error flag (0=no-error 1=command received out of the idle time) BIT 12: IR word error flag (0=no-error 1=wrong command received) BIT 11: scan word error flag (0=no-error 1=wrong command received) BIT 10: IR detector status flag (0=off 1=on) BIT 9: IR detector ADC latch-up status (0=no-latchup 1=latchup during acquisition) BIT 8: always 0 BIT 7: always 0 BIT 6: annealing heater last received cmd (0=off 1=on) BIT 5: always 0 BIT 4: always 0 BIT 3: last cover command direction (0=Close 1=Open) BIT 2: close position HES1 (0=Closed 1=Not closed) BIT 1: open position HES2 (0=Open 1=Not open) BIT 0: always 0
--------------	--	---

**Notes** The  $a_d$  and  $b_d$  coefficients are referred to the following transfer function

$$TF: Y = a_d * X_{ADU} + b_d$$

(Note 1): To convert the DT470 voltage value to Kelvin unit, refer to the following LakeShore table:

Temperature (Kelvin)	Voltage (Volt)	Temperature (Kelvin)	Voltage (Volt)
330	0.44647	150	0.86873
320	0.47069	140	0.89072
310	0.49484	130	0.91243
305	0.50688	120	0.93383
300	0.51892	110	0.95487
290	0.54294	100	0.9755
280	0.5669	95	0.98564
273.15	0.58327	90	0.99565
270	0.5908	85	1.00552
260	0.61465	80	1.01525
250	0.63841	77.35	1.02032
240	0.66208	75	1.02482
230	0.68564	70	1.03425
220	0.70908	65	1.04353
210	0.73238	60	1.05267
200	0.75554	58	1.05629
190	0.77855	56	1.05988
180	0.80138	54	1.06346
170	0.82404	52	1.067
160	0.8465	50	1.07053

(Note 2): To convert the PT500 resistance value to Kelvin unit, refer to the following Rosemount resistance-temperature table.

Temperature (Kelvin)	Resistance (Ohm)	Temperature (Kelvin)	Resistance (Ohm)
673.15	1244.49	333.15	617.39
653.15	1209.37	313.15	578.49
633.15	1174.03	293.15	539.36
613.15	1138.47	273.15	500
593.15	1102.68	253.15	460.31
573.15	1066.68	233.15	420.33
553.15	1030.46	213.15	380.03
533.15	994.01	193.15	339.41
513.15	957.34	173.15	298.43
493.15	920.46	153.15	257.03
473.15	883.36	133.15	215.14
453.15	846.03	113.15	172.64
433.15	808.48	93.15	129.5
413.15	770.71	73.15	86.1
393.15	732.72	53.15	44.62
373.15	694.5	33.15	12.67
353.15	656.05	13.15	1.25

TM- 10: (PID51, PC4, T3, ST25, Sid6) H H/K

Telemetry Packet Information (VIRTIS)			
Packet name	H H/K	Instrument	VIRTIS
Packet Function	To provide housekeeping data of VIRTIS-H channel		
Generation Rules	Periodic when enabled and PEM-H is on: - every 10 s when no science data production is performed - at internal PEM-H repetition rate during science data production		
Header Information			
Process ID	51	Packet Category	4
Service Type	3	Service Subtype	25
Structure ID	6	Packet Length	87
Data Field Information			
Data Field	Field Structure	Remarks	
SID	Enumerated Integer 16 bits (PTC 2, PFC 16)	BIT 13..15 = value=6 BIT 0..12 = always 0	
HKRq_Int_Num2	Unsigned Integer (PTC 3, PFC 12)	BIT 8..15 = Integration time MSW BIT 0..7 = always 0	
HKRq_Int_Num1	Unsigned Integer (PTC 3, PFC 12)	BIT 6..15 = Integration time LSW BIT 0..5 = always 0 Integration time = Integration time LSW + Integration time MSW * 1024) * 512 10 <sup>-6</sup> unit=sec	
HKRq_Bias	Unsigned Integer (PTC 3, PFC 12)	BIT 8..15 = Detector required bias $V_{detadj} = K * HKRq\_Bias + C$ (V) $a_d = 0.0146$ $b_d = -0.001$ unit=Volt BIT 0..7 = always 0 valid only if detector is On , HKRq_Det/On=1 Operational limits: if HKRq_Det/On=1 then 2.67V to 2.735V	
HKRq_I_Lamp	Unsigned Integer (PTC 3, PFC 12)	BIT 8..15 = Calibration lamp required current $I_{Lamp} = K * HKRq\_I\_Lamp + C$ (mA) $K = 0.09046$ $C = +0.005$ unit=mA BIT 0..7 = always 0	
HKRq_I_Shutter	Unsigned Integer (PTC 3, PFC 12)	BIT 8..15 = Shutter required current $I_{Shutter} = K * HKRq\_I\_Shutter + C$ (mA) $K = 5.031E-01$ $C = 0$ unit=mA BIT 0..7 = always 0	
HKRq_PEM_Mode	Unsigned Integer (PTC 3, PFC 12)	BIT 14..15 = PEM-H mode (0=Observation_8orders 1=Observation_full_matrix 2=Simulation_8orders 3=Simulation_full_matrix) BIT 0..13 = always 0	
HKRq_Test_Init	Unsigned Integer (PTC 3, PFC 12)	BIT 6..15 =Requested initial data in test mode $a_d = 1$ $b_d = 0$ unit=ADU BIT 0..5 = always 0	

HK_Rq_Device/On	Unsigned Integer (PTC 3, PFC 12)	BIT15: HKRq_Det/On, Detector Power On/Off request received (0=commanded Off, 1=commanded On) BIT 14: HKRq_Shutter/On, Shutter On or Off request received (0=commanded Open, 1=commanded Close) BIT 13: HKRq_FPAHtr/On, Annealing On or Off request received (0=commanded Off, 1=commanded On) BIT 12: HKRq_Lamp_Spect_T/On, Spectral Calibration Lamp Telescope On/Off request received (0=all lamps commanded Off, 1=Spectral lamp commanded On) BIT 11: HKRq_Lamp_Spect_S/On, Spectral Calibration Lamp Slit On/Off request received (0=all lamps commanded Off, 1=Spectral lamp commanded On) BIT 10: HKRq_Lamp_Radio/On, Radiometric Calibration Lamp On/Off request received (0=all lamps commanded Off, 1=Radiometric lamp commanded On) BIT 9 HKRq_Temp_Det/On, Temp meas. by detector temp sensor On/Off request received (0=commanded Off, 1=commanded On) BIT 8: HKRq_Status_Shutter/On, Shutter Status device ON/OFF request received ((0=both leds commanded Off, 1=both leds commanded On) BIT 7:HKMs_Req_during_Acq (0= no error, 1=Request(s) have arrived during data acquisition) BIT 0..6 = always 0
HKRq_Cover	Unsigned Integer (PTC 3, PFC 12)	BIT 15: HKRq_Cover_Dir, V-H cover has been commanded open/ closed (0=Close, 1=Open) BIT 14: HKRq_Cover_Wave, V-H cover motor wave one/half (0=half wave, 1=one wave) BIT 13: HKRq_Cover_Status, V-H cover HALL sensors have been commanded On/Off (0=Off, 1=On) BIT 6..12: HKRq_Cover_Step, V-H cover motor commanded number of steps BIT 0..5 = always 0
HKMs_Status	Unsigned Integer (PTC 3, PFC 12)	BIT 15: HKMs_ADC_Latchup (0=no-latchup, 1=ADC Latch-up has occurred) BIT 14: HKMs_Shutter/Closed, Shutter Status: 0=Closed, 1=not closed, valid only if Shutter Status device ON HKRq_Status_Shutter/On=1 BIT 13: HKMs_Shutter/Open, Shutter Status: 0=Open, 1=not open, valid only if Shutter Status device ON HKRq_Status_Shutter/On=1 BIT 12: FPGA_HES_1_H, close position HES1 (0=Closed 1=Not closed) BIT 11: FPGA_HES_2_H, open position HES2 (0=Open 1=Not open) BIT 10: HKMs_Annealing_Limit_Flag, The annealing security is active (the FPA temp is above the safe annealing temperature) 1 = Annealing authorised 0 = Annealing NOT authorised BIT 0..9 = always 0



HKMs_V_Line_Ref	Signed integer 16 b (PTC4, PFC12)	V at beginning of last detector line $V\_Line\_Ref = K * HKMs\_V\_Line\_Ref + C (V)$ for EQM: $K = 3.058 e-4, C = 0$ for FM: $K = 3.09025 e-4, C = +0.0025$ valid only if detector is On , HKRq_Det/On=1 Operational limits: <ul style="list-style-type: none"> <li>if (HKRq_Det/On=1 and H_HK_Periodic=0 science) then 2.8V to 3.4V</li> </ul>
HKMs_Vdet_Dig	Signed integer 16 b (PTC4, PFC12)	V supply detector (digital) $VDET\_DIG = K * HKMs\_Vdet\_Dig + C (V)$ for EQM: $K = 3.059 e-4, C = 0$ for FM: $K = 3.795 e-4, C = -1.1134$ valid only if detector is On , HKRq_Det/On=1 Operational limits: <ul style="list-style-type: none"> <li>if HKRq_Det/On=1 then 4.75V to 5.25V</li> </ul>
HKMs_Vdet_Ana	Signed integer 16 b (PTC4, PFC12)	V supply detector (Analog) $VDET\_ANA = K * HKMs\_Vdet\_Ana + C (V)$ for EQM: $K = 3.057 e-4, C = 0$ for FM: $K = 1.321 e-2, C = -208.39$ valid only if detector is On , HKRq_Det/On=1 Operational limits: <ul style="list-style-type: none"> <li>if HKRq_Det/On=1 then 4.75V to 5.25V</li> </ul>
HKMs_V_Detcom	Signed integer 16 b (PTC4, PFC12)	V Bias Detector (fixed) $VDETCOM = K * HKMs\_V\_Detcom + C (V)$ for EQM: $K = 3.057 e-4, C = 0$ for FM: $K = 1e-3, C = -7.146$ valid only if detector is On , HKRq_Det/On=1 Operational limits: <ul style="list-style-type: none"> <li>if HKRq_Det/On=1 then 3.18V to 3.22V</li> </ul>
HKMs_V_Detadj	Signed integer 16 b (PTC4, PFC12)	V Bias Detector (commanded by HSET_Bias) $VDETADJ = K * HKMs\_V\_Detadj + C (V)$ for EQM: $K = 3.057 e-4, C = 0$ for FM: $K = 3.093 e-4, C = +5e-3$ valid only if detector is On , HKRq_Det/On=1 Operational limits: <ul style="list-style-type: none"> <li>if HKRq_Det/On=1 then 2.67V to 2.735V</li> </ul>
HKMs_V+5	Signed integer 16 b (PTC4, PFC12)	V Pwr +5v (Logic) $V+5V = K * HKMs\_V+5 + C (V)$ for EQM: $K = 3.025 e-4, C = 0$ for FM: $K = 3.11 e-4, C = +3 e-2$ Operational limits: 4.75V to 5.25V
HKMs_V+12	Signed integer 16 b (PTC4, PFC12)	V Pwr +12v (Analogic) $V+12V = K * HKMs\_V+12 + C (V)$ for EQM: $K = 8.202 e-4, C = 0$ for FM: $K = 7.8375 e-4, C = +0.111$ Operational limits: 11.4V to 12.6V
HKMs_V+21	Signed integer 16 b (PTC4, PFC12)	V Pwr +21v (Shutter, Heater) $V+21V = K * HKMs\_V+21 + C (V)$ for EQM: $K = 1.273 e-3, C = 0$ for FM: $K = 1.2512 e-3, C = +1.5 e-2$ Operational limits: 20V to 24V
HKMs_V-12	Signed integer 16 b (PTC4, PFC12)	V Pwr -12v (Analogic) $V-12V = K * HKMs\_V-12 + C (V)$ for EQM: $K = 8.109 e-4, C = 0$ for FM: $K = 7.82 e-4, C = +1e-3$ Operational limits: -12.6V to -11.4V



HKMs_Temp_Vref	Signed integer 16 b (PTC4, PFC12)	Vref Temp measurements Temp-Ref = $K * HKMs\_Temp\_Vref + C$ (V) for EQM: $K = 8.113 e-4, C = 0$ for FM: $K = 7.829 e-4, C = +0.106$ Operational limits: TBD
HKMs_Det_Temp	Signed integer 16 b (PTC4, PFC12)	FPA Temp by internal sensor Det_Temp = $a * HK^2 + b * HK + c$ (K) For EQM: Has not been determined For FM $a = 0 \quad b = -0.03495 \quad c = 546$ valid only if detector temp sensor On, HKRq_Temp_Det/On = 1 Operational limits: <ul style="list-style-type: none"> <li>if HKRq_Det/On (detector sensor status) = 1 (ON) then 75K to 190K</li> </ul>
HKMs_Gnd	Signed integer 16 b (PTC4, PFC12)	Ground reference Ground ref. = $HKMs\_Gnd - C$ (ADU) for EQM has not been determined for FM: $K=1 \quad C = 0$ Operational limits: -10 to +10
HKMs_I_Vdet_Ana	Signed integer 16 b (PTC4, PFC12)	I Detector (analog) $I\_VDET\_ANA = K * HKMs\_I\_Vdet\_Ana + C$ (mA) for EQM: $K = 6.643 e-3, C = 0$ for FM: $K = 6.64 e-3, C = +0.088$ valid only if detector is On , HKRq_Det/On=1 Operational limits: <ul style="list-style-type: none"> <li>if HKRq_Det/On=1 then 5mA to 20mA</li> </ul>
HKMs_I_Vdet_Dig	Signed integer 16 b (PTC4, PFC12)	I Detector (digital) $I\_VDET\_ANA = K * HKMs\_I\_Vdet\_Ana + C$ (mA) for EQM: $K = 3.119 e-3, C = 0$ for FM: $K = 3.11 e-3, C = +0.022$ valid only if detector is On , HKRq_Det/On=1 Operational limits: <ul style="list-style-type: none"> <li>if HKRq_Det/On=1 then 0.05mA to 2mA</li> </ul>
HKMs_I_+5	Signed integer 16 b (PTC4, PFC12)	I Pwr +5v (Logic) $I\_+5V = K * HKMs\_I\_+5 + C$ (mA) for EQM: $K = 3.216 e-1, C = 0$ for FM: $K = 0.307, C = +3.4$ Operational limits: 80mA to 200mA
HKMs_I_+12	Signed integer 16 b (PTC4, PFC12)	I Pwr +12v (Analog) $I\_+12V = K * HKMs\_I\_+12 + C$ (mA) for EQM: $K = 1.373 e-1, C = 0$ for FM: $K = 0.1554, C = -1.95$ Operational limits: 70mA to 150mA
HKMs_I_Lamp	Signed integer 16 b (PTC4, PFC12)	I of selected Calibration Lamp $I\_Lamps = K * HKMs\_I\_Lamp + C$ (mA) for EQM: $K = 3.265 e-2, C = 0$ for FM: $K = 0.03292, C = -1.73$ valid only if one lamp is On , HKRq_Lamp_Spect_T/On = 1 HKRq_Lamp_Spect_S/On = 1 HKRq_Lamp_Radio/On = 1 Operational limits: <ul style="list-style-type: none"> <li>if HKRq_Lamp_Spect_T/On = 1 then 10mA to 15mA</li> <li>if HKRq_Lamp_Spect_S/On = 1 then 10mA to 15mA</li> <li>if HKRq_Lamp_Radio/On = 1 then 10mA to 15mA</li> </ul>

HKMs_I_Shutter/Heater	Signed integer 16 b (PTC4, PFC12)	I of Shutter or Heater $I_{Shutter/heater} = K * HKMs\_I\_Shutter/Heater + C$ <b>(mA)</b> for EQM: $K = 1.41 \text{ e-4}$ , $C = 0$ for FM: $K = 0.1489$ , $C = -6.4$ valid only if device is On , $HKRq\_Shutter/On = 1$ or $HKRq\_FPAHtr/On = 1$ Operational limits: <ul style="list-style-type: none"> <li>-9mA to +6mA</li> <li>if <math>HKRq\_Shutter/On = 1</math> then 45mA to 62mA</li> <li>if <math>HKRq\_FPAHtr/On = 1</math> then 100mA to 200mA</li> </ul>
HKMs_Temp_Prism	Signed integer 16 b (PTC4, PFC12)	Prism temp Like in the following the value of the corresponding HK is "HK" and the value of the corresponding temperature is "T" $T = a * HK^2 + b * HK + c$ (°C for EQM, <b>K</b> for FM) for EQM: $a = -2 \text{ e-7}$ $b = 0.0246$ $c = -224.48$ For FM: $a = 1.97 \text{ e-7}$ $b = 0.0244$ $c = +49.3$ Operational limits : 130K to 160K
HKMs_Temp_Cal_S	Signed integer 16 b (PTC4, PFC12)	Slit (Spectral) Lamp temp $T = a * HK^2 + b * HK + c$ (°C for EQM, <b>K</b> for FM) for EQM $a = 2 \text{ e-7}$ $b = 0.0246$ $c = -224.34$ for FM $a = 2 \text{ e-7}$ $b = 0.0243$ $c = +49.3$ Operational limits : 130K to 160K
HKMs_Temp_Cal_T	Signed integer 16 b (PTC4, PFC12)	Tel. Spectral & Radio Lamps temp $T = a * HK^2 + b * HK + c$ (°C for EQM, <b>K</b> for FM) for EQM: $a = 2 \text{ e-7}$ $b = 0.0246$ $c = -224.89$ for EQM: $a = 2 \text{ e-7}$ $b = 0.0243$ $c = +49.1$ Operational limits : 130K to 160K
HKMs_Temp_Shut	Signed integer 16 b (PTC4, PFC12)	Shutter temp $T = a * HK^2 + b * HK + c$ (°C for EQM, <b>K</b> for FM) For EQM: $a = 2 \text{ e-7}$ $b = 0.0246$ $c = -275.24$ For FM: $a = 2 \text{ e-7}$ $b = 0.0237$ $c = +6.6$ Operational limits : 130K to 160K
HKMs_Temp_Grating	Signed integer 16 b (PTC4, PFC12)	Grating temp $T = a * HK^2 + b * HK + c$ (°C for EQM, <b>K</b> for FM) For EQM: $a = 2 \text{ e-7}$ $b = 0.0246$ $c = -224.53$ For FM: $a = 2 \text{ e-7}$ $b = 0.0243$ $c = +48.3$ Operational limits : 130K to 160K
HKMs_Temp_Objective	Signed integer 16 b (PTC4, PFC12)	Objective temp $T = a * HK^2 + b * HK + c$ (°C for EQM, <b>K</b> for FM) for EQM: $a = 2 \text{ e-7}$ $b = 0.0247$ $c = -223.94$ for FM: $a = 2 \text{ e-7}$ $b = 0.0243$ $c = +49.2$ Operational limits : 130K to 160K

HKMs_Temp_FPA	Signed integer 16 b (PTC4, PFC12)	FPA temp $T = a * HK^2 + b * HK + c$ (°C for EQM, K for FM) For EQM: $a = 2 \text{ e-}7$ $b = 0.0246$ $c = -224.03$ For FM: $a = 2 \text{ e-}7$ $b = 0.0244$ $c = +48.6$ Operational limits : 65K to 190K
HKMs_Temp_PEM	Signed integer 16 b (PTC4, PFC12)	PEM temperature $T = a * HK^2 + b * HK + c$ (°C) For EQM (estimated) $a = 2 \text{ e-}7$ $b = 0.0246$ $c = -224.49$ For FM $a = 3.364 \text{ e-}06$ $b = -2.9526 \text{ e-}02$ $c = 0$ Operational limits : -30°C to +60°C
HKDH_Last_Sent_Request	Unsigned Integer (PTC 3, PFC 12)	Last request sent to PEM-H, Sent only once. If no new request, send 0. Never send HSTART_S nor HSTART_HK!
H_HK_Periodic	Unsigned Integer (PTC 3, PFC 12)	BIT 15: description of HK acquisition type 1 $\Leftrightarrow$ periodic HKs acquisition 0 $\Leftrightarrow$ science HKs acquisition BIT 0..14 = always 0
<b>Notes:</b>		

### 3.2.1.3 Event Reporting TMs

This service provides for the reporting to ground or DMS of unambiguous operational information such as:

- failures and/or anomalies detected on-board
- autonomous on-board actions
- normal progress of payload operation/activities

Event reports:

- identifies uniquely the event, its occurrence time and related data
- are generated only once per event occurrence and are concise
- includes the nature/severity of the event
- are self standing (i.e. not require data from other packets or TC history to be interpreted)

**NOTE:** Event reports represent an higher level of information than H/K reports, therefore they are the preferred method to perform monitoring activities.

Each event report type has its Event Identifier (like H/K reports have their SID). Event reports have fixed structure per EID.

Following the general format of the four SubType of event packets is showed while the table (TAB. 9: List of Event report EIDs pag.105) shows all the complete list of Event Report types as defined for the VIRTIS instrument; their EIDs are derived from a selected list controlled by the project. For the VIRTIS instrument 500 EIDs values have been assigned in the following range (see RD1):

47501 – 48000

TM- 11: (PID51, PC7, T5, ST1, EID47501...48000) Normal\_Progress\_Event\_Report

Telemetry Packet Information (VIRTIS)			
Packet name	Nota 1	Instrument	VIRTIS
Packet Function	Nota 1		
Generation Rules	Nota 1		
Header Information			
Process ID	51	Packet Category	7
Service Type	5	Service Subtype	1
Structure ID	N.A.	Packet Length	19
Data Field Information			
Data Field	Field Structure	Remarks	
EID	Unsigned Integer 16 bits (PTC 3, PFC 12)	Event Report Id = 47501...48000	
Parameter 1	Unsigned Integer 16 bits (PTC 3, PFC 12)	Value depends on event (EID), see <b>TAB. 9: List of Event report EIDs</b>	
Parameter 2	Unsigned Integer 16 bits (PTC 3, PFC 12)	Value depends on event (EID), see <b>TAB. 9: List of Event report EIDs</b>	
Parameter 3	Unsigned Integer 16 bits (PTC 3, PFC 12)	Value depends on event (EID), see <b>TAB. 9: List of Event report EIDs</b>	
Parameter 4	Unsigned Integer 16 bits (PTC 3, PFC 12)	Value depends on event (EID), see <b>TAB. 9: List of Event report EIDs</b>	
<b>Notes:</b> This Event packet format is applicable to all events of category IX (See par. 1.2 Autonomy Concept for category description) (Nota 1) depends on event (EID), see <b>TAB. 9: List of Event report EIDs</b>			

TM- 12: (PID51, PC7, T5, ST2, EID47501...48000) Anomaly\_Warning\_Event\_Report

Telemetry Packet Information (VIRTIS)			
Packet name	Nota 1	Instrument	VIRTIS
Packet Function	Nota 1		
Generation Rules	Nota 1		
Header Information			
Process ID	51	Packet Category	7
Service Type	5	Service Subtype	2
Structure ID	N.A.	Packet Length	19
Data Field Information			
Data Field	Field Structure	Remarks	
EID	Unsigned Integer 16 bits (PTC 3, PFC 12)	Event Report Id = 47501...48000	
Parameter 1	Unsigned Integer 16 bits (PTC 3, PFC 12)	Value depends on event (EID), see <a href="#">TAB. 9: List of Event report EIDs</a>	
Parameter 2	Unsigned Integer 16 bits (PTC 3, PFC 12)	Value depends on event (EID), see <a href="#">TAB. 9: List of Event report EIDs</a>	
Parameter 3	Unsigned Integer 16 bits (PTC 3, PFC 12)	Value depends on event (EID), see <a href="#">TAB. 9: List of Event report EIDs</a>	
Parameter 4	Unsigned Integer 16 bits (PTC 3, PFC 12)	Value depends on event (EID), see <a href="#">TAB. 9: List of Event report EIDs</a>	
<b>Notes:</b> This Event packet format is applicable to all events of category I/1, I/2, II, III,IV/H and IV/M (See par. 1.2 Autonomy Concept for category description) (Nota 1) depends on event (EID), see <a href="#">TAB. 9: List of Event report EIDs</a>			

TM- 13: (PID51, PC7, T5, ST3, EID47501...48000) Ground\_Action\_Event\_Report

Telemetry Packet Information (VIRTIS)			
Packet name	Nota 1	Instrument	VIRTIS
Packet Function	Nota 1		
Generation Rules	Nota 1		
Header Information			
Process ID	51	Packet Category	7
Service Type	5	Service Subtype	3
Structure ID	N.A.	Packet Length	19
Data Field Information			
Data Field	Field Structure	Remarks	
EID	Unsigned Integer 16 bits (PTC 3, PFC 12)	Event Report Id = 47501...48000	
Parameter 1	Unsigned Integer 16 bits (PTC 3, PFC 12)	Value depends on event (EID), see <b>TAB. 9: List of Event report EIDs</b>	
Parameter 2	Unsigned Integer 16 bits (PTC 3, PFC 12)	Value depends on event (EID), see <b>TAB. 9: List of Event report EIDs</b>	
Parameter 3	Unsigned Integer 16 bits (PTC 3, PFC 12)	Value depends on event (EID), see <b>TAB. 9: List of Event report EIDs</b>	
Parameter 4	Unsigned Integer 16 bits (PTC 3, PFC 12)	Value depends on event (EID), see <b>TAB. 9: List of Event report EIDs</b>	
<b>Notes:</b> This Event packet format is applicable to all events of category VI (See par. 1.2 Autonomy Concept for category description) (Nota 1) depends on event (EID), see <b>TAB. 9: List of Event report EIDs</b>			

TM- 14: (PID51, PC7, T5, ST4, EID47501...48000) OnBoard\_Action\_Event\_Report

Telemetry Packet Information (VIRTIS)			
Packet name	Nota 1	Instrument	VIRTIS
Packet Function	Nota 1		
Generation Rules	Nota 1		
Header Information			
Process ID	51	Packet Category	7
Service Type	5	Service Subtype	4
Structure ID	N.A.	Packet Length	19
Data Field Information			
Data Field	Field Structure	Remarks	
EID	Unsigned Integer 16 bits (PTC 3, PFC 12)	Event Report Id = 47501...48000	
Parameter 1	Unsigned Integer 16 bits (PTC 3, PFC 12)	Value depends on event (EID), see <b>TAB. 9: List of Event report EIDs</b>	
Parameter 2	Unsigned Integer 16 bits (PTC 3, PFC 12)	Value depends on event (EID), see <b>TAB. 9: List of Event report EIDs</b>	
Parameter 3	Unsigned Integer 16 bits (PTC 3, PFC 12)	Value depends on event (EID), see <b>TAB. 9: List of Event report EIDs</b>	
Parameter 4	Unsigned Integer 16 bits (PTC 3, PFC 12)	Value depends on event (EID), see <b>TAB. 9: List of Event report EIDs</b>	
<b>Notes:</b> This Event packet format is applicable to all events of category V/1, V/2 and V/3, (See par. 1.2 Autonomy Concept for category description) (Nota 1) depends on event (EID), see <b>TAB. 9: List of Event report EIDs</b>			



Event ID	Cat.	Packet Name + Parameter (16bit)	Issued by	Packet function/Description	Recommended Action by User
<b>GENERAL EVENTS (47501 ... 47550)</b>					
47501	IX	EVENT_SECONDARY_BOOT_COMPLETE Parameter see TM- 14: (PID51, PC7, T5, ST4, EID47501...48000) OnBoard_Action_Event_Report	E	Secondary Boot S/W is successfully started	N/A
47502	IX	EVENT_EEPROM_STAT Parameter see TM- 16: (PID51, PC7, T5, ST1, EID47502) EVENT_EEPROM_STAT	P	Status report of EEPROM content	N/A
47503	I/1	EVENT_WRONG_EVENT_CAT Par1: Event ID (event code + wrong event category) Par2: empty (0x0000) Par3: empty (0x0000) Par4: empty (0x0000)	E	Wrong event category detected, must be in range CAT_O ... CAT_X in Event handler	No action by user possible (S/W re-design /re-coding needed)
47504	I/1	EVENT_SW_53_COMPR_BUFFER_OVERFLOW Par1: empty (0x0000) Par2: empty (0x0000) Par3: empty (0x0000) Par4: empty (0x0000)	E	Internal memory usage exceeded (buffer overflow) during compression	No action by user possible (S/W re-design /re-coding needed)
47505	I/1	EVENT_SW_53_COMPR_SIZE_WRONG Par1: XS size value of compression unit (SSL) Par2: YS size value of compression unit (SSL) Par3: empty (0x0000) Par4: empty (0x0000)	E	compression parameter unit size wrong (XS, YS not a multiple of 8)	No action by user possible (S/W re-design /re-coding needed)
47506	I/1	EVENT_SW_53_COMPR_IBR_WRONG Par1: Value compression parameter IBR Par2: empty (0x0000) Par3: empty (0x0000) Par4: empty (0x0000)	E	Compression parameter 'ibr' out of range (not in range of 0 ...63)	No action by user possible (S/W re-design /re-coding needed)
47507	I/1	EVENT_SW_53_COMPR_UNKNOWN_ERROR Par1: Returned error code by compression function Par2: empty (0x0000) Par3: empty (0x0000) Par4: empty (0x0000)	E	Compression function returns unknown error code, must be in range -1 ... -3	No action by user possible (S/W re-design /re-coding needed)

Event ID	Cat.	Packet Name + Parameter (16bit)	Issued by	Packet function/Description	Recommended Action by User
47508	I/1	EVENT_SW_CALL_NOT_ACTIVE_TASK Par1: Task ID (MSW) Par2: Task ID (LSW) Par3: Task name (MSW) Par4: Task name (LSW)	E	Attempt to call a not active VIRTUOSO task	No action by user possible (S/W re-design /re-coding needed)
47509	I/1	EVENT_ENTER_SAFE_MODE_CMDANDED	E	The TC_Enter_Safe_Mode was commanded possibly in Science mode which reset the DPU and therefore stops the data acquisition, switches-off the coolers, the PEMs and goes in ME_SAFE mode	Not nominal commanding should be avoided. Use of TC_Disable_Science_*, XTC_PEM(Off) or XTC_Cooler(Off) is recommended
47510	I/1	EVENT_ENTER_IDLE_MODE_CMDANDED	E	The TC_Enter_Idle_Mode was commanded possibly in Science mode which stops the data acquisition, switches-off the coolers and the PEMs and goes in ME_IDLE mode	Not nominal commanding should be avoided. Use of TC_Disable_Science_*, XTC_PEM(Off) or XTC_Cooler(Off) is recommended
47511	I/1	EVENT_SW_53_COMP_FACTOR_LESS_THAN_1	E	The Compression factor is less than 1, than means the data amount after compression is higher than before compression	This can happen mainly in ME test mode for compression pseudo random test pattern (very strong noise). Change the mode or no compression.
47522	I/1	EVENT_SW_212_NO_TC_PACKET_BLOCK_FREE Par1: empty (0x0000) Par2: empty (0x0000) Par3: empty (0x0000) Par4: empty (0x0000)	E	Out of high level TC memory pool	Send VTC_Enter_Idle_Mode or VTC_Enter_Safe_Mode for restart or reboot the Secondary Boot S/W (EEPROM-S/W)
47523	I/1	EVENT_SW_212_FIFO_OVERFLOW Par1: empty (0x0000) Par2: empty (0x0000) Par3: empty (0x0000) Par4: empty (0x0000)	E	S/W FIFO overflow	Try last action once more, if failed switch to redundant DPU
47524 ... 47525		FREE			
47526	I/1	EVENT_SW_26_LINK_NOT_ESTABLISHED Par1: empty (0x0000) Par2: empty (0x0000) Par3: empty (0x0000) Par4: empty (0x0000)	E	HRD Link is not established	Establish the HRD link by using TC_Reset_And_Start_HS_Link

Event ID	Cat.	Packet Name + Parameter (16bit)	Issue d by	Packet function/Description	Recommended Action by User
47527	I/1	EVENT_SW_237_HRD_TM_TRANSFER_TIME_OUT Par1: empty (0x0000) Par2: empty (0x0000) Par3: empty (0x0000) Par4: empty (0x0000)	E	HRD TM packet transfer time out. A TM packet took more than 500ms transfer time via HS link.	There is a bad peak HS link data acquisition performance. Disable Science data transfer, change the VIRTIS mode with lower data rate on the HS link.
47528	I/1	EVENT_SW_26_WRONG_HRD_PACKET_SIZE Par1: Wrong HRD packet size value Par2: empty (0x0000) Par3: empty (0x0000) Par4: empty (0x0000)	E	HRD packet size is wrong	Restart the Science data transfer possibly due to an SEU effect in DPU Data or Programm memory
47529		FREE			
47530	VII	EVENT_SW_23_TM_APID_WRONG Par1: Wrong APID value Par2: empty (0x0000) Par3: empty (0x0000) Par4: empty (0x0000)	B	TM packet ID is wrong, not a valid APID for Safe Mode (APID 51, PCAT 1,4, 7 or 9)	Restart the Science data transfer possibly due to an SEU effect in DPU Data or Programm memory
47531	V/2	EVENT_SW_233_HK_SID_WRONG Par1: Wrong SID value Par2: empty (0x0000) Par3: empty (0x0000) Par4: empty (0x0000)	B	SID of HK TM data block is wrong	No action by user possible (S/W re-design /re-coding needed)
47532	V/2	EVENT_SW_614_RAM_RD_ADDRESS_WRONG Par1: Wrong address MSW Par2: Wrong address LSW Par3: empty (0x0000) Par4: empty (0x0000)	B	RAM Read/Write address is wrong	No action by user possible (S/W re-design /re-coding needed)
47533	V/2	EVENT_SW_614_RAM_RD_BLOCK_SIZE_WRONG Par1: Wrong block size value Par2: empty (0x0000) Par3: empty (0x0000) Par4: empty (0x0000)	B	RAM Read/Write block size is wrong	No action by user possible (S/W re-design /re-coding needed)
47534	V/2	EVENT_SW_614_RAM_RD_WR_MODE_WRONG Par1: Wrong RAM read/write mode Par2: empty (0x0000) Par3: empty (0x0000) Par4: empty (0x0000)	B	RAM Read/Write mode is wrong	No action by user possible (S/W re-design /re-coding needed)

Event ID	Cat.	Packet Name + Parameter (16bit)	Issued by	Packet function/Description	Recommended Action by User
47535	V/3	EVENT_SW_612_EEPROM_NO_BOOT_DATA_FOUND Par1: EEPROM address MSW Par2: EEPROM address LSW Par3: empty (0x0000) Par4: empty (0x0000)	P	No secondary boot data found at given address	Check EEPROM address in Enter Idle Mode TC, Send VTC_Get_EEPROM_Status in order to get the right start address of the executable
47536	V/2	EVENT_SW_6_WATCH_MODE_WRONG Par1: Wrong watchdog mode parameter value Par2: empty (0x0000) Par3: empty (0x0000) Par4: empty (0x0000)	B	Watchdog mode is wrong, only INIT, TRIGGER or RESET allowed	No action by user possible (S/W re-design /re-coding needed)
47537	V/2	EVENT_SW_6_TIMER_WRONG Par1: Wrong timer name / number Par2: empty (0x0000) Par3: empty (0x0000) Par4: empty (0x0000)	P	Timer number is not valid, must be TIMER_1, TIMER_2 or TIMER_3	No action by user possible (S/W re-design /re-coding needed)
47538	V/2	EVENT_SW_6_TIMER_MODE_WRONG Par1: Wrong timer mode value Par2: empty (0x0000) Par3: empty (0x0000) Par4: empty (0x0000)	P	Timer mode is not valid, must be RD or WR	No action by user possible (S/W re-design /re-coding needed)
47539	V/2	EVENT_SW_25_SCET_TIMER_MODE_WRONG Par1: Wrong SCET timer mode value Par2: empty (0x0000) Par3: empty (0x0000) Par4: empty (0x0000)	B	Parameter mode (RD/WR) for SCET Timer driver is wrong	No action by user possible (S/W re-design /re-coding needed)
47540	O	EVENT_SW_24_SDT_BUFFER_COMPLETE Par1: empty (0x0000) Par2: empty (0x0000) Par3: empty (0x0000) Par4: empty (0x0000)	B	SDT buffer is completed now, ready for transfer	<b>nothing to do !!</b>
47541	V/2	EVENT_SW_24_SDT_BLOCK_STATUS_WRONG Par1: Current SDT buffer block size Par2: Current SDT buffer size Par3: empty (0x0000) Par4: empty (0x0000)	B	SDT-Block size is more than maximum block size (6144)	Try last action once more after reboot of the S/W, if failed switch to redundant DPU
47542	III	EVENT_SW_24_SDT_BUFFER_FULL Par1: empty (0x0000) Par2: empty (0x0000) Par3: empty (0x0000) Par4: empty (0x0000)	B	SDT TM packet buffer is full	check that SDT polling is enabled by S/C (SIS or EGSE), Reset DPU (VTC_Enter_Safe_Mode) or TM buffer (TC_Reset_TM_Output_Buffer)

Event ID	Cat.	Packet Name + Parameter (16bit)	Issued by	Packet function/Description	Recommended Action by User
47543	V/2	EVENT_SW_24_NO_SDT_BLOCK_IN_BUFFER Par1: empty (0x0000) Par2: empty (0x0000) Par3: empty (0x0000) Par4: empty (0x0000)	B	Buffer don't contain a complete SDT block for transfer	No action by user possible (S/W re-design /re-coding needed)
47544	V/2	EVENT_SW_613_EEPROM_SWITCH_VAL_WRONG Par1: Wrong EEPROM switch value Par2: empty (0x0000) Par3: empty (0x0000) Par4: empty (0x0000)	P	Parameter for switching EEPROM is not ON/OFF	No action by user possible (S/W re-design /re-coding needed)
47545	V/2	EVENT_SW_613_EEPROM_RD_WR_MODE_WRONG Par1: Wrong EEPROM read/write mode value Par2: empty (0x0000) Par3: empty (0x0000) Par4: empty (0x0000)	P	Read/Write mode for EEPROM is wrong	No action by user possible (S/W re-design /re-coding needed)
47546	V/2	EVENT_SW_613_EEPROM_NOT_ENOUGH_SPACE Par1: empty (0x0000) Par2: empty (0x0000) Par3: empty (0x0000) Par4: empty (0x0000)	P	Not enough space in EEPROM for reading/writing data block	Check EEPROM address and size in Load Memory TC, shall be in range of 0x20000000 ... 0x200fffff
47547	V/2	EVENT_SW_613_EEPROM_ADDRESS_WRONG Par1: Wrong EEPROM address MSW Par2: Wrong EEPROM address LSW Par3: empty (0x0000) Par4: empty (0x0000)	P	Address for writing into EEPROM is wrong	Check EEPROM address in TC_Load_Memory, shall be in range of 0x20000000 ... 0x200fffff
47548	V/2	EVENT_SW_613_EEPROM_BLOCK_SIZE_IS_ZERO Par1: empty (0x0000) Par2: empty (0x0000) Par3: empty (0x0000) Par4: empty (0x0000)	P	Data block size for read/write EEPROM is zero	No action by user possible (S/W re-design /re-coding needed)
47549	O	EVENT_SW_3_4_VIR_DATA_CHANNEL_WRONG Par1: empty (0x0000) Par2: empty (0x0000) Par3: empty (0x0000) Par4: empty (0x0000)	E	Selected VIRTIS data channel is wrong	No action by user possible (S/W re-design /re-coding needed)
47550	V/2	EVENT_SW_0_CRC_BLOCK_SIZE_IS_ZERO Par1: empty (0x0000) Par2: empty (0x0000) Par3: empty (0x0000) Par4: empty (0x0000)	B	Block size for CRC calculation is zero	No action by user possible (S/W re-design /re-coding needed)

Event ID	Cat.	Packet Name + Parameter (16bit)	Issued by	Packet function/Description	Recommended Action by User
<b>ME Unit Hardware related Events/Errors (47601 ... 47700)</b>					
47601	V/2	EVENT_ME_MLC_FIFO_FULL Par1: empty (0x0000) Par2: empty (0x0000) Par3: empty (0x0000) Par4: empty (0x0000)	B	MLC FIFO overflow, no more TC's can be received and executed	- reduce the TC data rate - reboot of ME
47602	V/2 in Safe mode I/1 in other modes	EVENT_ME_SCET_WRONG Par1: Read SCET timer value MSW Par2: Read SCET timer value MID Par3: Read SCET timer value LSW Par4: empty (0x0000)	B	SCET Timer value has a deviation to the received time (Service 9) more as allowed (+/- 20ms)	Take care for updating the proper consistent SCET by TC
47603	V/2	EVENT_ME_PS_DAT_ID_WRONG Par1: Sent PS command Par2: Received PS data word Par3: empty (0x0000) Par4: empty (0x0000)	B	Dat-ID received from power supply is not equal to Cmd-ID	Try last action once more after reboot, if failed switch to redundant DPU
47604	V/2	EVENT_ME_DPU_DM1_WRITE_WRONG Par1: address LSW Par2: empty (0x0000) Par3: empty (0x0000) Par4: empty (0x0000)	P	Write error occurred in DPU base data memory	Try last action once more, if failed switch to redundant DPU
47605	V/2*	EVENT_ME_EEPROM_WRITE_WRONG Par1: EEPROM address MSW Par2: EEPROM address LSW Par3: empty (0x0000) Par4: empty (0x0000)	P	Write error EEPROM	Try last action once more after reboot, if failed switch to redundant DPU
47606	V/2*	EVENT_SW_612_EEPROM_START_SEG_WRONG Par1: EEPROM address MSW Par2: EEPROM address LSW Par3: Segment ID MSW Par4: Segment ID LSW	P	No segment header found at EEPROM start address	Send VTC_Get_EEPROM_Status in order to get the current EEPROM status, if failed perform upload of executable into EEPROM once more

Event ID	Cat.	Packet Name + Parameter (16bit)	Issued by	Packet function/Description	Recommended Action by User
47607	V/2*	EVENT_SW_612_BOOT_END_SEG_FAILED Par1: empty (0x0000) Par2: empty (0x0000) Par3: empty (0x0000) Par4: empty (0x0000)	P	End segment in EEPROM is missing or wrong	Send VTC_Get_EEPROM_Status in order to get the current EEPROM status, if failed perform upload of executable into EEPROM once more
47608	V/2*	EVENT_SW_612_BOOT_SEG_CRC_WRONG Par1: Boot address MSW Par2: Boot address LSW Par3: CRC read from boot memory (EEPROM/RAM) Par4: CRC calculated	P	Segment checksum error in EEPROM	Perform upload of executable into EEPROM once more in order to overwrite the wrong version
47609	V/2	EVENT_ME_DPU_DM2_WRITE_WRONG Par1: Image RAM address LSW Par2: empty (0x0000) Par3: empty (0x0000) Par4: empty (0x0000)	P	Write error occurred in image data memory	Try last action once more after reboot, if failed switch to redundant DPU
47610	V/2	EVENT_ME_PS_NO_RESPONSE Par1: Sent PS command Par2: empty (0x0000) Par3: empty (0x0000) Par4: empty (0x0000)	B	No response from Power Supply after sending a command	Try last action once more after reboot, if failed switch to redundant DPU
47611	V/2	EVENT_ME_PS_ADC_DATA_WRONG Par1: Sent PS command Par2: empty (0x0000) Par3: empty (0x0000) Par4: empty (0x0000)	B	ADC data obtained from Power Supply are wrong	Check ADC power status (HK, Test Display) after reboot, if OK, switch to the redundant DPU
47612	I/1	EVENT_ME_SEU_DETECTED Par1: MSW of memory address Par2: LSW of memory address Par3: Memory ID (141, 142, 143, see TC_Upload_Memory) Par4: Failure mode 0=bit is flipped from 1 to 0 1=bit is flipped from 0 to 1	E	a Single Event Upset is detected in ME DPU Image memory RAM, Data Memory RAM or Program Memory RAM The check is done only in "free" (not used) memory areas. The checked memory size is 3kwords, that means less than 1% of the total DPU memory area.	The user should decide (depends on the event frequency) whether a VIRTIS operation is temporary useful or not because the science data could be corrupted or the software could crash due to memory flipping failure.
47613 .... 47628		FREE			



Event ID	Cat.	Packet Name + Parameter (16bit)	Issued by	Packet function/Description	Recommended Action by User
47629	I/1	EVENT_ME_PS_UNKNOWN_ERROR_CODE Par1: Received error code from PS Par2: empty (0x0000) Par3: empty (0x0000) Par4: empty (0x0000)	B	Error code received from Power Supply is unknown	Send VTC_Enter_Safe_Mode for reboot the Secondary Boot S/W (EEPROM-S/W), try the last action once more, if failed switch to the redundant DPU
47630	I/1	EVENT_SC_TC_CONFIRMATION_FAILED Par1: empty (0x0000) Par2: empty (0x0000) Par3: empty (0x0000) Par4: empty (0x0000)	E	Confirmation of last received TC failed	Send the confirmation TC as very next TC after sending of the TC to be confirmed
47631	I/1	EVENT_SCET_RUNS_UNSYNCHRONIZED Par1: Current SCET time MSW Par2: Current SCET time MID Par3: Current SCET time LSW Par4: empty (0x0000)	P	SCET timer runs unsynchronized, no time update execution is performed (only in Safe mode) but TC is accepted	In order to set SCET timer with synchronized time, send VTC_Enter_Safe_Mode and activate Time Update Service
47632 .... 47647		FREE			
47648	I/1	EVENT_ME_HK_DPU_VOLTAGE_OUT_OF_RANGE Par1: Received DPU voltage value (dig) Par2: empty (0x0000) Par3: empty (0x0000) Par4: empty (0x0000)	E	Expected DHSU voltage out of range (4.5...5.5V)	Switch to the redundant DPU
47649	I/1	EVENT_ME_HK_PS_TEMP_OUT_OF_RANGE Par1: Received PS temperature value (dig) Par2: empty (0x0000) Par3: empty (0x0000) Par4: empty (0x0000)	E	Expected Power Supply temperature out of range (-30°C...+80°C)	Switch of VIRTIS-H/M cooler/PEM (VTC_Enter_Idle_Mode), if temperature still out of range, switch to redundant DPU
47650	I/1	EVENT_ME_HK_DPU_TEMP_OUT_OF_RANGE Par1: Received DPU temperature value (dig) Par2: empty (0x0000) Par3: empty (0x0000) Par4: empty (0x0000)	E	Expected DPU temperature out of range (-30°C...+80°C)	Switch of the ME-Box and switch on again, if error occurs once more, switch to redundant DPU
47651		FREE			
47652	I/1	EVENT_IFE_INVALID_PORT_ADDRESS Par1: Wrong port address MSW Par2: Wrong port address LSW Par3: empty (0x0000) Par4: empty (0x0000)	E	M-IFE port address for commanding PEM's is wrong	No action by user possible (S/W re-design /re-coding needed)



Event ID	Cat.	Packet Name + Parameter (16bit)	Issue d by	Packet function/Description	Recommended Action by User
47653	V/2	EVENT_ME_HRD_PARITY_WRONG Par1: empty (0x0000) Par2: empty (0x0000) Par3: empty (0x0000) Par4: empty (0x0000)	E	HRD channel parity wrong	Re-establish the HRD link by using TC_Reset_And_Start_HS_Link
47654	V/2	EVENT_ME_HRD_DISCONNECT Par1: empty (0x0000) Par2: empty (0x0000) Par3: empty (0x0000) Par4: empty (0x0000)	E	HRD channel disconnection	Re-establish the HRD link by using TC_Reset_And_Start_HS_Link
47655	V/2	EVENT_SC_HS_LINK_COMMANDDED_TWICE Par1: empty (0x0000) Par2: empty (0x0000) Par3: empty (0x0000) Par4: empty (0x0000)	E	TC_Reset_And_Start_HS_Link was commanded twice which is danger, therefore CATV/2	ME Internally there is a problem of science data consistency if the HS link is tried to be established twice in ME_IDLE mode. The user should never do this otherwise the science data are corrupted. Start the HS link only once which should work normally, otherwise use the other DPU (main or redundant).
47656 .... 47657		FREE			
47658	V/2	EVENT_ME_PS_CMD_VIR_MONITOR_FAIL Par1: Sent PS command Par2: empty (0x0000) Par3: empty (0x0000) Par4: empty (0x0000)	B	PS detected VIRTIS monitor failure	Try commanding once more after reboot, if failed, switch to the redundant DPU
47659	V/2*	EVENT_ME_PS_CMD_VIR_UNDERVOLTAGE Par1: Sent PS command Par2: empty (0x0000) Par3: empty (0x0000) Par4: empty (0x0000)	B	PS detected VIRTIS under-voltage error	Try commanding once more after reboot, if failed, switch to the redundant DPU
47660	V/2*	EVENT_ME_PS_CMD_VIR_OVERVOLTAGE Par1: Sent PS command Par2: empty (0x0000) Par3: empty (0x0000) Par4: empty (0x0000)	B	PS detected VIRTIS over-voltage error	Try commanding once more after reboot, if failed, switch to the redundant DPU
47661	V/2	EVENT_ME_PS_CMD_EXECUTE_ERROR Par1: Sent PS command Par2: empty (0x0000) Par3: empty (0x0000) Par4: empty (0x0000)	B	PS detected an execution error	Try commanding once more after reboot, if failed, switch to the redundant DPU

Event ID	Cat.	Packet Name + Parameter (16bit)	Issued by	Packet function/Description	Recommended Action by User
47662	V/2	EVENT_ME_PS_CMD_UNKNOWN Par1: Sent PS command Par2: empty (0x0000) Par3: empty (0x0000) Par4: empty (0x0000)	B	PS received an unknown command	Try commanding once more after reboot, if failed, switch to the redundant DPU
47663	V/2	EVENT_ME_PS_CMD_SHADOW_WRONG Par1: Sent PS command Par2: empty (0x0000) Par3: empty (0x0000) Par4: empty (0x0000)	B	PS detected a shadow command error	Try commanding once more after reboot, if failed, switch to the redundant DPU
47664	V/2	EVENT_ME_PS_POW_STAT_WRONG Par1: Sent PS command, see RD(13) Par2: Received PS data word, see RD(13) Par3: empty (0x0000) Par4: empty (0x0000)	B	PS Status after commanding is wrong	Try commanding once more after reboot, if failed, switch to the redundant DPU
47665	V/2	EVENT_ME_PS_ADC_NOT_ON Par1: empty (0x0000) Par2: empty (0x0000) Par3: empty (0x0000) Par4: empty (0x0000)	B	ADC is not on before reading analogous HK	Try HK acquisition once more, if failed, switch to the redundant DPU
47666	O	EVENT_ME_EEPROM_NO_EXE_END_FOUND Par1: EEPROM address MSW Par2: EEPROM address LSW Par3: empty (0x0000) Par4: empty (0x0000)	P	No end segment for executable found in EEPROM	Check EEPROM status by VTC_Get_EEPROM_Status
47667	V/2	EVENT_ME_DPU_BBC_WRITE_WRONG Par1: BBC status LSW Par2: empty (0x0000) Par3: empty (0x0000) Par4: empty (0x0000)	P	BBC register initialization failed	Try initialization once more after reboot, else switch to redundant DPU
47668	V/2	EVENT_ME_DPU_REG_WRITE_WRONG Par1: Register address LSW Par2: empty (0x0000) Par3: empty (0x0000) Par4: empty (0x0000)	P	DPU register initialization failed	Try initialization once more after reboot, else switch to redundant DPU
47669	V/2	EVENT_ME_WATCHDOG_DISABLED Par1: empty (0x0000) Par2: empty (0x0000) Par3: empty (0x0000) Par4: empty (0x0000)	B	Watchdog is disabled, safety function not active !!	Try initialization once more after reboot, else switch to redundant DPU

Event ID	Cat.	Packet Name + Parameter (16bit)	Issue d by	Packet function/Description	Recommended Action by User
47670	V/2	EVENT_ME_TIMER_3_NOT_READABLE Par1: empty (0x0000) Par2: empty (0x0000) Par3: empty (0x0000) Par4: empty (0x0000)	P	TIMER_3 is write only, mode=RD is not valid for this timer	No action by user possible (S/W re-design /re-coding needed)
47671	V/2* PRO M  O EEP ROM	EVENT_ME_SCET_TIMER_NOT_RUNNING Par1: empty (0x0000) Par2: empty (0x0000) Par3: empty (0x0000) Par4: empty (0x0000)	B	SCET Timer is not running after setting or before reading	Try SCET time update once more after reboot, if failed switch to redundant DPU
47672	O	EVENT_ME_EEPROM_NO_EXE_VERSION_FOUND Par1: EEPROM address MSW Par2: EEPROM address LSW Par3: empty (0x0000) Par4: empty (0x0000)	P	No version number of executable found in EEPROM	The executable in EEPROM was possibly not built correct. As the S/W developer to provide proper executable to be uploaded.
47673	O	EVENT_ME_EEPROM_NO_EXE_FOUND Par1: EEPROM address MSW Par2: EEPROM address LSW Par3: empty (0x0000) Par4: empty (0x0000)	P	No valid executable found in EEPROM	The executable in EEPROM was possibly not built correct. As the S/W developer to provide proper executable to be uploaded.
47674	V/3	EVENT_ME_EEPROM_WRITE_ERROR Par1: EEPROM address MSW Par2: EEPROM address LSW Par3: empty (0x0000) Par4: empty (0x0000)	P	Data written into EEPROM are wrong	Try memory upload once more after reboot, if failed switch to the redundant DPU
47675	V/3	EVENT_ME_EEPROM_NOT_WRITEABLE Par1: EEPROM address MSW Par2: EEPROM address LSW Par3: empty (0x0000) Par4: empty (0x0000)	P	Writing of data into EEPROM failed	Try last action once more after reboot, if failed switch to redundant DPU
47676 .... 47679		FREE			
47680	I/1	EVENT_NO_VTC_CONFIRM_AFTER_CRITICAL_TC Par1: empty (0x0000) Par2: empty (0x0000) Par3: empty (0x0000) Par4: empty (0x0000)	E	No VTC_Confirm received after a critical TC	Send the critical TC once more with a following VTC_Confirm for this TC

Event ID	Cat.	Packet Name + Parameter (16bit)	Issued by	Packet function/Description	Recommended Action by User
47681	V/3	EVENT_ME_EEPROM_CURRENT_PARAMETER_UPDATE_WRONG Par1: empty (0x0000) Par2: empty (0x0000) Par3: empty (0x0000) Par4: empty (0x0000)	E	Update of current parameter in EEPROM failed	Try last action once more after reboot, if failed switch to redundant DPU
47682	V/2	EVENT_SC_TC_UPLOAD_MEM_ID_WRONG Par1: Wrong memory ID value Par2: empty (0x0000) Par3: empty (0x0000) Par4: empty (0x0000)	P	Memory ID for upload must be in range of 140 ... 145	Check 'Memory ID' in TC_Load_Memory
47683	V/2	EVENT_SC_TC_UPLOAD_FORMAT_WRONG Par1: Wrong number of blocks Par2: empty (0x0000) Par3: empty (0x0000) Par4: empty (0x0000)	P	Number of memory blocks to be uploaded must be "1"	Check 'blocks to be loaded' in TC_Load_Memory, must be 1
47684	V/2	EVENT_SC_TC_UPLOAD_SIZE_WRONG Par1: Wrong upload size value Par2: empty (0x0000) Par3: empty (0x0000) Par4: empty (0x0000)	P	Upload memory size is out of range	Check 'data block length' in TC_Load_Memory against 'Memory ID'
47685	V/2	EVENT_SC_TC_UPLOAD_ADDRESS_WRONG Par1: Wrong upload address MSW Par2: Wrong upload address LSW Par3: empty (0x0000) Par4: empty (0x0000)	P	Upload memory address is out of range	Check address in TC_Load_Memory
47686	V/2	EVENT_SC_TC_DUMP_FORMAT_WRONG Par1: Wrong number of blocks Par2: empty (0x0000) Par3: empty (0x0000) Par4: empty (0x0000)	P	Number of memory blocks to be dumped must be one	Check 'blocks to be loaded' in TC_Dump_Memory, must be 1
47687	V/2	EVENT_SC_TC_CHECK_FORMAT_WRONG Par1: Wrong number of blocks Par2: empty (0x0000) Par3: empty (0x0000) Par4: empty (0x0000)	P	Number of memory blocks to be checked must be one	Check 'blocks to be loaded' in TC_Check_Memory, must be 1

Event ID	Cat.	Packet Name + Parameter (16bit)	Issued by	Packet function/Description	Recommended Action by User
47688	O	EVENT_ME_MLC_FIFO_EMPTY Par1: empty (0x0000) Par2: empty (0x0000) Par3: empty (0x0000) Par4: empty (0x0000)	B	MLC FIFO is empty	N/A
47689	III	EVENT_SC_TC_WRONG_SAFE_MODE_TC Par1: empty (0x0000) Par2: empty (0x0000) Par3: empty (0x0000) Par4: empty (0x0000)	P	TC not allowed in Safe Mode	Check why the TC is not allowed, change the mode by VTC_Enter_Safe_Mode and try it again
47690	O	EVENT_ME_SDT_FIFO_HALF_FULL Par1: empty (0x0000) Par2: empty (0x0000) Par3: empty (0x0000) Par4: empty (0x0000)	B	SDT FIFO is more than half full, transfer to S/C not possible	N/A
47691	V/2*	EVENT_ME_SDT_FIFO_FULL Par1: empty (0x0000) Par2: empty (0x0000) Par3: empty (0x0000) Par4: empty (0x0000)	B	SDT FIFO overflow	No action by user possible (S/W re-design /re-coding needed), SDT-buffer is reset after reboot
47692	V/2	EVENT_ME_PS_EEPROM_NOT_OFF Par1: empty (0x0000) Par2: empty (0x0000) Par3: empty (0x0000) Par4: empty (0x0000)	P	Switching off the EEPROM power not successful	Try last action once more after reboot, if failed switch to redundant DPU
47693	V/2	EVENT_ME_PS_EEPROM_NOT_ON Par1: empty (0x0000) Par2: empty (0x0000) Par3: empty (0x0000) Par4: empty (0x0000)	P	Switching on the EEPROM power not successful	Try last action once more after reboot, if failed switch to redundant DPU
47694	V/2	EVENT_ME_PS_STAT_WRONG Par1: empty (0x0000) Par2: empty (0x0000) Par3: empty (0x0000) Par4: empty (0x0000)	B	PS_DATA_RDY of DPU extension status is not low	Try last action once more after reboot, if failed switch to redundant DPU
47695	V/2	EVENT_ME_DPU_NO_BBC_STATUS_AVAILABLE Par1: empty (0x0000) Par2: empty (0x0000) Par3: empty (0x0000) Par4: empty (0x0000)	B	Reading of BBC status failed	Try last action once more after reboot, if failed switch to redundant DPU

Event ID	Cat.	Packet Name + Parameter (16bit)	Issued by	Packet function/Description	Recommended Action by User
47696	V/2	EVENT_ME_DPU_REG_ISR_WRONG Par1: wrong ISR reset value Par2: empty (0x0000) Par3: empty (0x0000) Par4: empty (0x0000)	P	Reset value of register ISR is wrong	Try last action once more after reboot, if failed switch to redundant DPU
47697	V/2	EVENT_ME_DPU_REG_TRS_WRONG Par1: Wrong TRS reset value Par2: empty (0x0000) Par3: empty (0x0000) Par4: empty (0x0000)	P	Reset value of register TRS is wrong	Try last action once more after reboot, if failed switch to redundant DPU
47698	V/2	EVENT_ME_DPU_INIT_ERROR Par1: empty (0x0000) Par2: empty (0x0000) Par3: empty (0x0000) Par4: empty (0x0000)	P	DPU initialization error	Try last action once more after reboot, if failed switch to redundant DPU
47699	V/2*	EVENT_ME_DPU_PM_WRITE_WRONG Par1: address LSW Par1: empty (0x0000) Par2: empty (0x0000) Par3: empty (0x0000) Par4: empty (0x0000)	B	Write error occurred in DPU program memory	Try last action once more after reboot, if failed switch to redundant DPU
47700	V/2	EVENT_ME_DISP_DRV_STAT_WRONG_LOW Par1: empty (0x0000) Par2: empty (0x0000) Par3: empty (0x0000) Par4: empty (0x0000)	B	Frame-Signal of Test-IF becomes not low	Try last action once more after reboot, if failed switch to redundant DPU
<b>VIRTIS-M CONTROL SOFTWARE EVENTS (47701 ... 47740)</b>					
47701	IX	EVENT_M_DUMP_DATA_PRODUCTION_PARAMETER Parameter see <b>TM- 17: (PID51, PC7, T5, ST1, EID47701)</b> <b>EVENT_M_DUMP_DATA_PRODUCTION_PARAMETER</b>	E	Dump of actual Data Production Parameter	N/A
47702	IX	EVENT_M_DUMP_FUNCTIONAL_PARAMETER Parameter see <b>TM- 18: (PID51, PC7, T5, ST1, EID47702)</b> <b>EVENT_M_DUMP_FUNCTIONAL_PARAMETER</b>	E	Dump of actual Functional Parameter	N/A
47703	IX	EVENT_M_DUMP_OPERATIONAL_PARAMETER Parameter see <b>TM- 19: (PID51, PC7, T5, ST1, EID47703)</b> <b>EVENT_M_DUMP_OPERATIONAL_PARAMETER</b>	E	Dump of actual Operational Parameter	N/A
47704	IX	EVENT_M_DUMP_ALTERNATE_PARAMETER Parameter see <b>TM- 20: (PID51, PC7, T5, ST1, EID47704)</b> <b>EVENT_M_DUMP_ALTERNATE_PARAMETER</b>	E	Dump of actual Alternate Parameter	N/A

Event ID	Cat.	Packet Name + Parameter (16bit)	Issued by	Packet function/Description	Recommended Action by User
47705	IX	EVENT_M_DUMP_CALIBRATION_PARAMETER Parameter see TM- 21: (PID51, PC7, T5, ST1, EID47705) EVENT_M_DUMP_CALIBRATION_PARAMETER	E	Dump of actual Calibration Parameter	N/A
47706	IX	EVENT_M_COOL_DOWN_END_SUCCESS Par1: empty (0x0000) Par2: empty (0x0000) Par3: empty (0x0000) Par4: empty (0x0000)	E	Cool down successful finished	N/A
47707	I/1	EVENT_M_SU_ANGLE_STEP_SIZE_NOT_INT_OF_ANGLE_RANGE Par1: empty (0x0000) Par2: empty (0x0000) Par3: empty (0x0000) Par4: empty (0x0000)	E	M SU movement angle range is not a multiple of step size	Change M functional parameter M_SU_ANGLE_STEP_SIZE or M_SU_ANGLE_FIRST/ M_SU_ANGLE_LAST
47708	I/1	EVENT_M_SU_FIRST_ANGLE_GREATER_LAST_ANGLE Par1: empty (0x0000) Par2: empty (0x0000) Par3: empty (0x0000) Par4: empty (0x0000)	E	M SU first angle is greater than last angle	Change M functional parameter M_SU_ANGLE_FIRST or M_SU_ANGLE_LAST
47709 ... 47734		FREE			
47735	I/1	EVENT_SW_342_MODE_USER_DEFINED_STARTED Par1: empty (0x0000) Par2: empty (0x0000) Par3: empty (0x0000) Par4: empty (0x0000)	E	-M user defined mode started	N/A
47736		FREE			
47737	I/1	EVENT_SW_31_M_PEM_CMD_FIFO_OVERFLOW Par1: empty (0x0000) Par2: empty (0x0000) Par3: empty (0x0000) Par4: empty (0x0000)	E	VIRTIS-M PEM command S/W FIFO overflow	Try last action once more, if failed switch to redundant DPU
47738	I/1	EVENT_M_VIS_DATA_SLICE_LOST Par1: empty (0x0000) Par2: empty (0x0000) Par3: empty (0x0000) Par4: empty (0x0000)	E	VIRTIS-M VIS data slice is lost during VIS slice (frame) acquisition by ME from M-PEM	1. use an other M-Mode where the M_ERT is longer or 2. increase the S/C (EGSE) data acquisition performance or 3. decrease M_SS in case of slice summing (i.e. M_SS>1)



Event ID	Cat.	Packet Name + Parameter (16bit)	Issued by	Packet function/Description	Recommended Action by User
47739	I/1	EVENT_M_IR_DATA_SLICE_LOST Par1: empty (0x0000) Par2: empty (0x0000) Par3: empty (0x0000) Par4: empty (0x0000)	E	VIRTIS-M IR data slice is lost during IR slice (frame) acquisition by ME from M-PEM	1. use an other M-Mode where the M_ERT is longer or 2. increase the S/C (EGSE) data acquisition performance or 3. decrease M_SS in case of slice summing (i.e. M_SS>1)
47740	I/1	EVENT_SW_34_M_MODE_UNVALID Par1: Wrong -M mode value Par2: empty (0x0000) Par3: empty (0x0000) Par4: empty (0x0000)	E	VIRTIS-M Mode is unvalid	Switch off VIRTIS-M and start session once more,
<b>VIRTIS-M TERMINATOR HARDWARE EVENTS (47741 ... 47800)</b>					
47741	I/1	EVENT_M_COOLER_STEADY_NOT_REACHED Par1: empty (0x0000) Par2: empty (0x0000) Par3: empty (0x0000) Par4: empty (0x0000)	E	-M steady state not reached, temperature too high	Command a higher temperature and start cool down once more by MTC_Cooler
47742	I/1	EVENT_M_COOLER_CMD_OFF_DURING_OPERATION Par1: empty (0x0000) Par2: empty (0x0000) Par3: empty (0x0000) Par4: empty (0x0000)	E	Attempt to switch-off the -M cooler during operation	No action by user needed
47743	I/1	EVENT_M_COOLER_CMD_OPEN_LOOP Par1: empty (0x0000) Par2: empty (0x0000) Par3: empty (0x0000) Par4: empty (0x0000)	E	Attempt to command the -M cooler during open loop mode	No action by user needed
47744	I/1	EVENT_M_COOLER_CMD_DURING_STEADY_STATE Par1: empty (0x0000) Par2: empty (0x0000) Par3: empty (0x0000) Par4: empty (0x0000)	E	Attempt to command the -M cooler during steady state	No action by user needed
47745	I/1	EVENT_M_COOLER_CMD_DURING_COOL_DOWN Par1: empty (0x0000) Par2: empty (0x0000) Par3: empty (0x0000) Par4: empty (0x0000)	E	Attempt to command the -M cooler during cool down	No action by user needed



Event ID	Cat.	Packet Name + Parameter (16bit)	Issued by	Packet function/Description	Recommended Action by User
47746	I/1	EVENT_M_ECA_ALREADY_MOVED Par1: empty (0x0000) Par2: empty (0x0000) Par3: empty (0x0000) Par4: empty (0x0000)	E	-M ECA is already moved, only one time possible	No action by user needed
47747	I/1	EVENT_M_ECA_NOT_MOVED Par1: empty (0x0000) Par2: empty (0x0000) Par3: empty (0x0000) Par4: empty (0x0000)	E	-M ECA not moved	Try once more to move the ECA
47748	II	EVENT_M_IR_DETECTOR_NOT_OFF Par1: empty (0x0000) Par2: empty (0x0000) Par3: empty (0x0000) Par4: empty (0x0000)	E	-M IR detector is not off	Try once more to switch off the detector
47749	I/1	EVENT_M_ANNEAL_NOT_POSSIBLE Par1: empty (0x0000) Par2: empty (0x0000) Par3: empty (0x0000) Par4: empty (0x0000)	E	-M annealing is not possible because detector could not be switched off	Try once more to start annealing and switching off the detector
47750	I/1	EVENT_M_ANNEAL_STOPPED_AFTER_EXCEED_TEMP Par1: commanded M_ANNEAL_LIMITS Par2: empty (0x0000) Par3: empty (0x0000) Par4: empty (0x0000)	E	-M annealing is stopped after exceeding temperature	No action by user needed
47751	I/1	EVENT_M_ANNEAL_STOPPED_AFTER_TIME_OUT Par1: commanded -M_ANNEAL_TIME_OUT Par2: empty (0x0000) Par3: empty (0x0000) Par4: empty (0x0000)	E	-M annealing is stopped after time out	Start annealing once more with lower M_ANNEAL_LIMITS (changed by MTC_Change_Func_Param_RAM)
47752	I/1	EVENT_M_COVER_CTRL_IN_M_MODE_X Par1: Current active -M mode Par2: empty (0x0000) Par3: empty (0x0000) Par4: empty (0x0000)	E	Attempt to control -M cover in mode x	Check the current -M mode and try action once more
47753	I/1	EVENT_M_COVER_ALREADY_CLOSED Par1: empty (0x0000) Par2: empty (0x0000) Par3: empty (0x0000) Par4: empty (0x0000)	E	-M cover is already closed	No action by user needed

Event ID	Cat.	Packet Name + Parameter (16bit)	Issued by	Packet function/Description	Recommended Action by User
47754	I/1	EVENT_M_COVER_ALREADY_OPEN Par1: empty (0x0000) Par2: empty (0x0000) Par3: empty (0x0000) Par4: empty (0x0000)	E	-M cover is already open	No action by user needed
47755	I/1	EVENT_M_COVER_OPEN Par1: empty (0x0000) Par2: empty (0x0000) Par3: empty (0x0000) Par4: empty (0x0000)	E	-M cover is open	No action by user needed
47756	I/1	EVENT_M_COVER_NOT_OPEN Par1: empty (0x0000) Par2: empty (0x0000) Par3: empty (0x0000) Par4: empty (0x0000)	E	-M cover is not open	Try last action once more (restart sequence)
47757	I/1	EVENT_M_COVER_CLOSED Par1: empty (0x0000) Par2: empty (0x0000) Par3: empty (0x0000) Par4: empty (0x0000)	E	-M cover is closed	No action by user needed
47758	I/1	EVENT_M_COVER_NOT_CLOSED Par1: empty (0x0000) Par2: empty (0x0000) Par3: empty (0x0000) Par4: empty (0x0000)	E	-M cover is not closed	Try last action once more (restart sequence)
47759	I/1	EVENT_M_SCIENCE_DATA_GENERATION_STOPPED Par1: EVENT_ID of Cat III error Par2: empty (0x0000) Par3: empty (0x0000) Par4: empty (0x0000)	E	-M science data generation is stopped	Check the occurred event and if possible try to restart the sequence once more
47760	I/1	EVENT_M_MODE_USER_DEFINED_STARTED Par1: empty (0x0000) Par2: empty (0x0000) Par3: empty (0x0000) Par4: empty (0x0000)	E	-M user defined mode started, no predefined mode reached	No action by user needed
47761	I/1	EVENT_M_IR_DATA_OUTSIDE_OF_RANGE Par1: empty (0x0000) Par2: empty (0x0000) Par3: empty (0x0000) Par4: empty (0x0000)	E	-M IR raw data outside of nominal range (61000...7500 DN)	No action possible

Event ID	Cat.	Packet Name + Parameter (16bit)	Issued by	Packet function/Description	Recommended Action by User
47762	I/1	EVENT_M_VIS_DATA_OUTSIDE_OF_RANGE Par1: VIS data range Par2: empty (0x0000) Par3: empty (0x0000) Par4: empty (0x0000)	E	-M VIS raw data outside of nominal range (16384...65535 DN)	No action possible
47763	III	EVENT_M_IR_LESS_DATA_THAN_EXPECTED Par1:Expected Nr of M-VIS words(MSW) Par2:Expected Nr of M-VIS words(LSW) Par3:Received Nr of M-VIS words(MSW) Par4:Received Nr of M-VIS words(LSW)	E	-M IR less data received than expected	Stop and restart sequence
47764	III	EVENT_M_IR_DATA_ACQ_TIME_OUT Par1: empty (0x0000) Par2: empty (0x0000) Par3: empty (0x0000) Par4: empty (0x0000)	E	-M IR data acquisition time out	Stop and restart sequence
47765	III	EVENT_M_VIS_DATA_ACQ_TIME_OUT Par1: empty (0x0000) Par2: empty (0x0000) Par3: empty (0x0000) Par4: empty (0x0000)	E	-M VIS data acquisition time out	Stop and restart sequence
47766	I/1	EVENT_M_COOL_STEADY_STATE_FAILURE Par1: cooler mode Par2: Cold tip temperature to be achieved Par3: empty (0x0000) Par4: empty (0x0000)	E	Commanded -M cooler temperature is not equal to the current cold tip temperature in steady state	Stop sequence, start cooling by MTC_Cooler once more, After reaching the steady state start sequence once more
47767	IX	EVENT_M_CALIBR_SEQ_PHASE_FINALIZED Par1: calibration phase number (1..6) Par2: empty (0x0000) Par3: empty (0x0000) Par4: empty (0x0000)	E	-M calibration sequence phase (1..6) is finalized	No action by user needed
47768	I/1	EVENT_M_SU_HK_WRONG Par1: M_MIRROR_SIN_HK Par2: empty (0x0000) Par3: empty (0x0000) Par4: empty (0x0000)	E	-M scan unit HK wrong (M_MIRROR_SIN_HK)	Stop and restart sequence
47769	I/1	EVENT_M_SHUTTER_NOT_OPEN Par1: empty (0x0000) Par2: empty (0x0000) Par3: empty (0x0000) Par4: empty (0x0000)	E	-M shutter not open	Stop and restart sequence

Event ID	Cat.	Packet Name + Parameter (16bit)	Issued by	Packet function/Description	Recommended Action by User
47770	I/1	EVENT_M_MODE_WRONG Par1: mode number Par2: empty (0x0000) Par3: empty (0x0000) Par4: empty (0x0000)	E	Wrong -M mode number	No action by user possible (S/W re-design /re-coding needed)
47771	I/2	EVENT_M_IR_ADC_LATCH_UP Par1: empty (0x0000) Par2: empty (0x0000) Par3: empty (0x0000) Par4: empty (0x0000)	E	IR channel ADC latch-up	Stop and restart sequence Due to CAT I/2, switch-off and on the M-PEM and M-Cooler again in order to probably see the event again.
47772	III	EVENT_M_IR_CMD_TIME_ERROR Par1: empty (0x0000) Par2: empty (0x0000) Par3: empty (0x0000) Par4: empty (0x0000)	E	IR channel command received out of idle time	Stop and restart sequence
47773	III	EVENT_M_IR_CMD_WORD_ERROR Par1: empty (0x0000) Par2: empty (0x0000) Par3: empty (0x0000) Par4: empty (0x0000)	E	IR channel bad command id or command value out of range	Stop and restart sequence
47774	I/2	EVENT_M_VIS_ADC_LATCH_UP Par1: empty (0x0000) Par2: empty (0x0000) Par3: empty (0x0000) Par4: empty (0x0000)	E	VIS channel ADC latch-up	Stop and restart sequence Due to CAT I/2, switch-off and on the M-PEM and M-Cooler again in order to probably see the event again.
47775	III	EVENT_M_VIS_CMD_TIME_ERROR Par1: empty (0x0000) Par2: empty (0x0000) Par3: empty (0x0000) Par4: empty (0x0000)	E	VIS channel command received out of idle time	Stop and restart sequence
47776	III	EVENT_M_VIS_CMD_WORD_ERROR Par1: empty (0x0000) Par2: empty (0x0000) Par3: empty (0x0000) Par4: empty (0x0000)	E	VIS channel bad command id or command value out of range	Stop and restart sequence
47777	I/2	EVENT_M_COOL_DOWN_END_FAILURE Par1: commanded temperature Par2: empty (0x0000) Par3: empty (0x0000) Par4: empty (0x0000)	E	Cool down not successful, expected temperature not reached	Start cool down once more by MTC_Cooler with a higher commanded temperature Due to CAT I/2, switch-off and on the M-PEM and M-Cooler again in order to probably see the event again.

Event ID	Cat.	Packet Name + Parameter (16bit)	Issue d by	Packet function/Description	Recommended Action by User
47778	I/1	EVENT_M_PEM_CCD_NOT_FULL_WIN_SIZE Par1:Commanded M_CCD_WIN_SIZE (MSW) Par2:Commanded M_CCD_WIN_SIZE (LSW) Par3: empty (0x0000) Par4: empty (0x0000)	E	-M VIS window size not nominal (876x512 CCD elements)	Change the window size by MTC_PEM_Command_Word in M_MODE_TEST
47779	I/2	EVENT_M_VIS_IFE_FIFO_CLK_NUMBER_WRONG Par1: empty (0x0000) Par2: empty (0x0000) Par3: empty (0x0000) Par4: empty (0x0000)	E	FIFO VIRTIS-M VIS channel clock number wrong	Stop and restart sequence Due to CAT I/2, switch-off and on the M-PEM and M-Cooler again in order to probably see the event again. A SEU on interface level could be detected.
47780	I/2	EVENT_M_IR_IFE_FIFO_CLK_NUMBER_WRONG Par1: empty (0x0000) Par2: empty (0x0000) Par3: empty (0x0000) Par4: empty (0x0000)	E	FIFO VIRTIS-M IR channel clock number wrong	Stop and restart sequence Due to CAT I/2, switch-off and on the M-PEM and M-Cooler again in order to probably see the event again. A SEU on interface level could be detected.
47781	I/1	EVENT_M_VIS_IFE_FIFO_EMPTY_FIFO_READ Par1: empty (0x0000) Par2: empty (0x0000) Par3: empty (0x0000) Par4: empty (0x0000)	E	FIFO VIRTIS-M VIS empty FIFO read	Stop and restart sequence
47782	I/1	EVENT_M_IR_IFE_FIFO_EMPTY_FIFO_READ Par1: empty (0x0000) Par2: empty (0x0000) Par3: empty (0x0000) Par4: empty (0x0000)	E	FIFO VIRTIS-M IR empty FIFO read	Stop and restart sequence
47783	I/1	EVENT_M_VIS_IFE_FIFO_RD_ORDER_WRONG Par1: empty (0x0000) Par2: empty (0x0000) Par3: empty (0x0000) Par4: empty (0x0000)	E	FIFO VIRTIS-M VIS read order wrong (MSB and LSB)	Stop and restart sequence
47784	I/1	EVENT_M_IR_IFE_FIFO_RD_ORDER_WRONG Par1: empty (0x0000) Par2: empty (0x0000) Par3: empty (0x0000) Par4: empty (0x0000)	E	FIFO VIRTIS-M IR read order wrong (MSB and LSB)	Stop and restart sequence
47785	III	EVENT_M_VIS_LESS_DATA_THAN_EXPECTED Par1:Expected Nr of M-VIS words(MSW) Par2:Expected Nr of M-VIS words(LSW) Par3:Received Nr of M-VIS words(MSW) Par4:Received Nr of M-VIS words(LSW)	E	-M VIS less data received than expected	Stop and restart sequence

Event ID	Cat.	Packet Name + Parameter (16bit)	Issue d by	Packet function/Description	Recommended Action by User
47786	I/1	EVENT_M_IR_DATA_SIZE_TOO_LARGE Par1:Expected Nr of M-IR words(MSW) Par2:Expected Nr of M-IR words(LSW) Par3:Received Nr of M-IR words(MSW) Par4:Received Nr of M-IR words(LSW)	E	VIRTIS-M IR more data received than expected	Send VTC_Enter_Idle_Mode (FIFO reset) and start data acquisition once more
47787	IV_M	EVENT_M_PEM_IR_CONNECTION_WRONG Par1: empty (0x0000) Par2: empty (0x0000) Par3: empty (0x0000) Par4: empty (0x0000)	E	VIRTIS-M IR channel PEM connection wrong	Switch off and once more on the PEM, if failed switch off VIRTIS-M
47788	III	EVENT_M_VIS_IFE_FIFO_NOT_EMPTY Par1: empty (0x0000) Par2: empty (0x0000) Par3: empty (0x0000) Par4: empty (0x0000)	E	VIRTIS-M IFE VIS FIFO not empty, more data than expected	Send VTC_Enter_Idle_Mode (FIFO reset) and start data acquisition once more
47789	III	EVENT_M_IR_IFE_FIFO_NOT_EMPTY Par1: empty (0x0000) Par2: empty (0x0000) Par3: empty (0x0000) Par4: empty (0x0000)	E	VIRTIS-M IFE IR FIFO not empty, more data than expected	Send VTC_Enter_Idle_Mode (FIFO reset) and start data acquisition once more
47790	I/1	EVENT_M_VIS_DATA_SIZE_TOO_LARGE Par1:Expected Nr of M-VIS words(MSW) Par2:Expected Nr of M-VIS words(LSW) Par3:Received Nr of M-VIS words(MSW) Par4:Received Nr of M-VIS words(LSW)	E	VIRTIS-M VIS more data received than expected	Send VTC_Enter_Idle_Mode (FIFO reset) and start data acquisition once more
47791	I/1	EVENT_M_PEM_IR_NOT_FULL_WIN_SIZE Par1:Commanded M_IR_WIN_SIZE (MSW) Par2:Commanded M_IR_WIN_SIZE (LSW) Par3: empty (0x0000) Par4: empty (0x0000)	E	-M IR window size is not nominal (432x256 pixel)	Change the window size by MTC_Change_Func_Param_RAM or MTC_PEM_Command_Word in M_MODE_TEST
47792	IV/M	EVENT_M_IFE_ACCESS_WRONG Par1: empty (0x0000) Par2: empty (0x0000) Par3: empty (0x0000) Par4: empty (0x0000)	E	VIRTIS-M IFE register access failed	Switch off IFE and on once more, if failed switch off VIRTIS-M
47793	IV_M	EVENT_M_PEM_VIS_CONNECTION_WRONG Par1: empty (0x0000) Par2: empty (0x0000) Par3: empty (0x0000) Par4: empty (0x0000)	E	VIRTIS-M VIS channel PEM connection wrong	Switch off and once more on the PEM, if failed switch off VIRTIS-M

Event ID	Cat.	Packet Name + Parameter (16bit)	Issued by	Packet function/Description	Recommended Action by User
47794	IV/M	EVENT_M_IFE_COMMAND_WRONG Par1: address register Par2: wrong command Par3: empty (0x0000) Par4: empty (0x0000)	E	Command transfer to VIRTIS-M failed	Try last action once more, if failed switch off VIRTIS-M
47795	I/1	EVENT_M_VIS_IFE_TEST_PATTERN_WRONG Par1: position wrong pattern LSW Par2: wrong pattern word Par3: empty (0x0000) Par4: empty (0x0000)	E	VIRTIS-M VIS IFE test pattern wrong	Try test pattern check once more, if failed switch off VIRTIS-M VIS channel
47796	I/1	EVENT_M_IR_IFE_TEST_PATTERN_WRONG Par1: position wrong pattern LSW Par2: wrong pattern word Par3: empty (0x0000) Par4: empty (0x0000)	E	VIRTIS-M IR IFE test pattern wrong	Try test pattern check once more, if failed switch off VIRTIS-M IR channel
47797	III	EVENT_M_VIS_IFE_FIFO_FULL Par1: empty (0x0000) Par2: empty (0x0000) Par3: empty (0x0000) Par4: empty (0x0000)	E	FIFO VIRTIS-M VIS overflow	Send VTC_Enter_Idle_Mode (FIFO reset) and start data acquisition once more
47798	III	EVENT_M_IR_IFE_FIFO_FULL Par1: empty (0x0000) Par2: empty (0x0000) Par3: empty (0x0000) Par4: empty (0x0000)	E	FIFO VIRTIS-M IR overflow	Send VTC_Enter_Idle_Mode (FIFO reset) and start data acquisition once more
47799	I/1	EVENT_M_VIS_IFE_FIFO_EMPTY Par1: expected number of words Par2: received number of words Par3: empty (0x0000) Par4: empty (0x0000)	E	FIFO VIRTIS-M VIS channel empty	Switch PEM off and on, start data acquisition once more
47800	I/1	EVENT_M_IR_IFE_FIFO_EMPTY Par1: expected number of words Par2: received number of words Par3: empty (0x0000) Par4: empty (0x0000)	E	FIFO VIRTIS-M IR channel empty	Switch PEM off and on, start data acquisition once more



Event ID	Cat.	Packet Name + Parameter (16bit)	Issued by	Packet function/Description	Recommended Action by User
47801	I/1	EVENT_M_SHUTTER_NOT_CLOSED Par1: empty (0x0000) Par2: empty (0x0000) Par3: empty (0x0000) Par4: empty (0x0000)	E	Attempt to close -M Shutter has failed	The event is issued due to a shutter status/HK hardware problem. Check that only the Shutter HK are wrong or the shutter doesn't work correctly. If the shutter doesn't work correctly the user is not able to do something.
47802	I/1	EVENT_M_PEM_HK_ACQUISITION_TIME_OUT Par1: empty (0x0000) Par2: empty (0x0000) Par3: empty (0x0000) Par4: empty (0x0000)	E	M-PEM HK acquisition time-out occurred	The -H housekeeping are not received from H-PEM. The user may try to reset of power-off/on the H-PEM. If the event is still received there is a hardware problem.
47803	I/1	EVENT_M_COVER_INIT_HES1_FAILED Par1: empty (0x0000) Par2: empty (0x0000) Par3: empty (0x0000) Par4: empty (0x0000)	E	HES1 (closed position) failed while M-Cover initialization	Check the M_Cover housekeeping where only the HES or the cover motor has a problem. If the cover motor is not working anymore use the M_ECA
47804	I/1	EVENT_M_COVER_NOT_OPEN_NOT_CLOSED Par1: empty (0x0000) Par2: empty (0x0000) Par3: empty (0x0000) Par4: empty (0x0000)	E	M-Cover is not open and not closed before initialization	check the M_Cover housekeeping, switch-off/on the M-PEM in order to re-initialize the M_Cover
47805	I/1	EVENT_M_COVER_CLOSING_FAILED Par1: empty (0x0000) Par2: empty (0x0000) Par3: empty (0x0000) Par4: empty (0x0000)	E	Closing of M-Cover failed	check the M_Cover housekeeping
47806	I/1	EVENT_M_IR_DET_IS_NOT_SWITCHED_ON	E	the M-IR detector is not switched on in any Science or Calibration modes	the user gets only simulated (by M-PEM) science data from the IR channel, not real science data If the user wants to have real science data the -M functional parameter M_IR_DET_OFF must be set not equal to 0x00FF.
<b>VIRTIS-H CONTROL SOFTWARE EVENTS (47901 ... 47930)</b>					
47901	IX	EVENT_H_DUMP_DATA_PRODUCTION_PARAMETER Parameter see TM- 22: (PID51, PC7, T5, ST1, EID47901) H_Dump_Data_Production_Parameter	E	Dump of actual Data Production Parameter	the user know that now H_Science data are produced
47902	IX	EVENT_H_DUMP_FUNCTIONAL_PARAMETER Parameter see TM- 23: (PID51, PC7, T5, ST1, EID47902) H_Dump_Functional_Parameter	E	Dump of actual Functional Parameter	the user know that now H_Science data are produced



Event ID	Cat.	Packet Name + Parameter (16bit)	Issued by	Packet function/Description	Recommended Action by User
47903	IX	EVENT_H_DUMP_OPERATIONAL_PARAMETER Parameter see <b>TM- 24: (PID51, PC7, T5, ST1, EID47903)</b> <b>H_Dump_Operational_Parameter</b>	E	Dump of actual Operational Parameter	the user know that now H_Science data are produced
47904	IX	EVENT_H_DUMP_PIXEL_MAP_PARAMETER Parameter see <b>TM- 25: (PID51, PC7, T5, ST1, EID47906)</b> <b>H_Dump_Pixel_Map_Parameter</b>	E	Dump of actual Pixel Map Parameter	the user know that now H_Science data are produced
47905	IX	EVENT_H_ANNEALING_FLAG Par1: empty (0x0000) Par2: empty (0x0000) Par3: empty (0x0000) Par4: empty (0x0000)	E	Annealing limit flag in PEM-HK is set	The annealing limit flag is set unexpected. There could be a hardware problem. May be switching off/on the H-PEM could help to recover the problem.
47906	IX	EVENT_H_COOL_DOWN_END_SUCCESS Par1: empty (0x0000) Par2: empty (0x0000) Par3: empty (0x0000) Par4: empty (0x0000)	E	Cool down successful finished	N/A
47907	I/1	EVENT_H_PIX_MAP_NOT_UPLOADED Par1: empty (0x0000) Par2: empty (0x0000) Par3: empty (0x0000) Par4: empty (0x0000)	E	H-Pixel Map is not uploaded yet	The upload of H pixel map was not successful. May be switching off/on the H-PEM and tray uploading again could help to recover the problem.
47908	I/1	EVENT_H_PIX_MAP_NR_OF_BITS_WRONG Par1: Number of pixels set to '1' in pixel map Par2: Expected number of pixel set to '1' (always = 17280) Par3: empty (0x0000) Par4: empty (0x0000)	E	Number of bits in H-Pixel Map is wrong	Check the H-Pixel Map coefficients especially related to order overlapping
47909	I/1	EVENT_H_PIX_MAP_WRONG Par1: Position of wrong pixel map byte (1... 14783) Par2: Value of wrong pixel map byte Par3: Value of expected pixel map byte Par4: empty (0x0000)	E	Downloaded H-Pixel Map is not equal to the uploaded one	Change of Pixel Map coefficients is needed commanding by TC.
47910	IX	EVENT_H_PIX_MAP_CHECK_SUCCESS Parameter see <b>TM- 26: (PID51, PC7, T5, ST1, EID47903)</b> <b>EVENT_H_PIX_MAP_CHECK_SUCCESS</b>	E	Check of H-Pixel Map was successful	N/A
47911 ... 47927		FREE			

Event ID	Cat.	Packet Name + Parameter (16bit)	Issue d by	Packet function/Description	Recommended Action by User
47928	I/1	EVENT_H_DATA_SLICE_LOST Par1: empty (0x0000) Par2: empty (0x0000) Par3: empty (0x0000) Par4: empty (0x0000)	E	VIRTIS-H data slice is lost due to a slow S/C data rate or high amount of data volume	change mode or lower data repetition rate
47929	I/1	EVENT_M_SUMMING_NOT_PERFORMED_WITH_FULL_WIN	E	Slice summing is not performed with full IR and VIS window size The processing time would be too high related to the DPU duty cycle	Change the M_ACQ_MODE or set M_SS=1, Use never M_SS>1 together with M_ACQ_MODE_FULL_WIN
47930	I/1	EVENT_SW_44_H_MODE_UNVALID Par1: -H mode number Par2: empty (0x0000) Par3: empty (0x0000) Par4: empty (0x0000)	E	VIRTIS-H Mode is invalid	Switch off VIRTIS-H and start session once more,
<b>VIRTIS-H TERMINATOR HARDWARE EVENTS (47931 ... 47980)</b>					
47931	I/1	EVENT_H_ADC_LATCH_UP Par1: empty (0x0000) Par2: empty (0x0000) Par3: empty (0x0000) Par4: empty (0x0000)	E	ADC latch up error detected in H-PEM HK	May be switching off/on the H-PEM could help to recover the problem.
47932	I/1	EVENT_H_HKMS_SHUTTER_STAT_WRONG Par1: empty (0x0000) Par2: empty (0x0000) Par3: empty (0x0000) Par4: empty (0x0000)	E	H-Shutter open and closed status bit values in H-PEM HK are not reverse to each other	May be switching off/on the H-PEM could help to recover the problem.
47933	I/1	EVENT_H_COVER_INIT_HES1_FAILED Par1: empty (0x0000) Par2: empty (0x0000) Par3: empty (0x0000) Par4: empty (0x0000)	E	HES1 (closed position) failed while H-Cover initialization	May be switching off/on the H-PEM could help to recover the problem.
47934	I/1	EVENT_H_COVER_NOT_OPEN_NOT_CLOSED Par1: empty (0x0000) Par2: empty (0x0000) Par3: empty (0x0000) Par4: empty (0x0000)	E	H-Cover is not open and not closed before initialization	May be switching off/on the H-PEM could help to recover the problem.

Event ID	Cat.	Packet Name + Parameter (16bit)	Issued by	Packet function/Description	Recommended Action by User
47935	I/1	EVENT_H_COVER_CLOSING_FAILED Par1: empty (0x0000) Par2: empty (0x0000) Par3: empty (0x0000) Par4: empty (0x0000)	E	Closing of H-Cover failed	May be switching off/on the H-PEM could help to recover the problem.
47936	I/1	EVENT_H_ANNEAL_NOT_STARTED_HK_WRONG Par1: H_HKMS_I_SHUTTER_HEATER Par2: H_HKRQ_DEVICE_ON Par3: H_HKMS_STATUS Par4: empty (0x0000)	E	Annealing is not started because HK are wrong	May be switching off/on the H-PEM could help to recover the problem.
47937	I/1	EVENT_H_ANNEAL_PEM_LIMIT_DETECT Par1: H_DET_TEMP (detector temperature) Par2: empty (0x0000) Par3: empty (0x0000) Par4: empty (0x0000)	E	Annealing limit exceeded	May be switching off/on the H-PEM could help to recover the problem.
47938	I/1	EVENT_H_PEM_HK_WRONG_DURING_ANNEAL Par1: HKMS_I_SHUTTER_HEATER Par2: H_HKRQ_DEVICE_ON Par3: H_HKMS_STATUS Par4: empty (0x0000)	E	HK are wrong during annealing process	May be switching off/on the H-PEM could help to recover the problem.
47939	I/1	EVENT_H_PEM_HK_OUT_OF_RANGE_AFTER_RESET Par1: empty (0x0000) Par2: empty (0x0000) Par3: empty (0x0000) Par4: empty (0x0000)	E	HK are out of range after PEM reset	May be switching off/on the H-PEM could help to recover the problem.
47940	I/1	EVENT_H_COVER_CTRL_IN_MODE_X Par1: Current active -H mode Par2: empty (0x0000) Par3: empty (0x0000) Par4: empty (0x0000)	E	Attempt to control -H cover in mode x	Check the current -H mode and try action once more
47941	I/1	EVENT_H_MODE_USER_DEFINED_STARTED Par1: empty (0x0000) Par2: empty (0x0000) Par3: empty (0x0000) Par4: empty (0x0000)	E	-H user defined mode started, no predefined mode reached	No action by user needed
47942	I/1	EVENT_H_WIN_SIZE_NOT_NOMINAL Par1: H_WIN_SIZE (MSW) Par2: H_WIN_SIZE (LSW) Par3: empty (0x0000) Par4: empty (0x0000)	E	-H window size not nominal (432x256)	No action by user needed

Event ID	Cat.	Packet Name + Parameter (16bit)	Issued by	Packet function/Description	Recommended Action by User
47943	I/1	EVENT_H_COOLER_STEADY_NOT_REACHED Par1: empty (0x0000) Par2: empty (0x0000) Par3: empty (0x0000) Par4: empty (0x0000)	E	-H steady state not reached, temperature too high	Command a higher temperature and start cool down once more by HTC_Cooler
47944	I/1	EVENT_H_COOLER_CMD_OFF_DURING_OPERATION Par1: empty (0x0000) Par2: empty (0x0000) Par3: empty (0x0000) Par4: empty (0x0000)	E	Attempt to switch-off the -H cooler during operation	No action by user needed
47945	I/1	EVENT_H_COOLER_CMD_OPEN_LOOP Par1: empty (0x0000) Par2: empty (0x0000) Par3: empty (0x0000) Par4: empty (0x0000)	E	Attempt to command the -H cooler during open loop mode	No action by user needed
47946	I/1	EVENT_H_COOLER_CMD_DURING_STEADY_STATE Par1: empty (0x0000) Par2: empty (0x0000) Par3: empty (0x0000) Par4: empty (0x0000)	E	Attempt to command the -H cooler during steady state	No action by user needed
47947	I/1	EVENT_H_COOLER_CMD_DURING_COOL_DOWN Par1: empty (0x0000) Par2: empty (0x0000) Par3: empty (0x0000) Par4: empty (0x0000)	E	Attempt to command the -H cooler during cool down	No action by user needed
47948	I/1	EVENT_H_ECA_ALREADY_MOVED Par1: empty (0x0000) Par2: empty (0x0000) Par3: empty (0x0000) Par4: empty (0x0000)	E	-H ECA is already moved, only one time possible	No action by user needed
47949	I/1	EVENT_H_ECA_NOT_MOVED Par1: empty (0x0000) Par2: empty (0x0000) Par3: empty (0x0000) Par4: empty (0x0000)	E	-H ECA not moved	Try once more to move the ECA
47950	II	EVENT_H_DETECTOR_NOT_OFF Par1: empty (0x0000) Par2: empty (0x0000) Par3: empty (0x0000) Par4: empty (0x0000)	E	-H detector is not off	Try once more to switch off the detector

Event ID	Cat.	Packet Name + Parameter (16bit)	Issued by	Packet function/Description	Recommended Action by User
47951	I/1	EVENT_H_ANNEAL_NOT_POSSIBLE Par1: empty (0x0000) Par2: empty (0x0000) Par3: empty (0x0000) Par4: empty (0x0000)	E	-H annealing is not possible because detector could not be switched off	Try once more to start annealing and switching off the detector
47952	I/1	EVENT_H_ANNEAL_STOPPED_AFTER_EXCEED_TEMP Par1: empty (0x0000) Par2: empty (0x0000) Par3: empty (0x0000) Par4: empty (0x0000)	E	-H annealing is stopped after exceeding temperature	No action by user needed
47953	I/1	EVENT_H_ANNEAL_STOPPED_AFTER_TIME_OUT Par1: empty (0x0000) Par2: empty (0x0000) Par3: empty (0x0000) Par4: empty (0x0000)	E	-H annealing is stopped after time out	Start annealing once more with lower M_ANNEAL_LIMITS (changed by MTC_Change_Func_Param_RAM)
47954	I/2	EVENT_ID_H_COOL_DOWN_END_FAILURE Par1: Commanded temperature Par2: empty (0x0000) Par3: empty (0x0000) Par4: empty (0x0000)	E	Cool down not successful, expected temperature not reached	command the cooler again Due to CAT I/2, switch-off and on the H-PEM and H-Cooler again in order to probably see the event again.
47955	I/1	EVENT_H_COVER_ALREADY_CLOSED Par1: empty (0x0000) Par2: empty (0x0000) Par3: empty (0x0000) Par4: empty (0x0000)	E	-H cover is already closed	No action by user needed
47956	I/1	EVENT_H_COVER_ALREADY_OPEN Par1: empty (0x0000) Par2: empty (0x0000) Par3: empty (0x0000) Par4: empty (0x0000)	E	-H cover is already open	No action by user needed
47957	I/1	EVENT_H_COVER_OPEN Par1: empty (0x0000) Par2: empty (0x0000) Par3: empty (0x0000) Par4: empty (0x0000)	E	-H cover is open	No action by user needed
47958	I/1	EVENT_H_COVER_NOT_OPEN Par1: empty (0x0000) Par2: empty (0x0000) Par3: empty (0x0000) Par4: empty (0x0000)	E	-H cover is not open	Try last action once more (restart sequence)

Event ID	Cat.	Packet Name + Parameter (16bit)	Issued by	Packet function/Description	Recommended Action by User
47959	I/1	EVENT_H_COVER_CLOSED Par1: empty (0x0000) Par2: empty (0x0000) Par3: empty (0x0000) Par4: empty (0x0000)	E	-H cover is closed	No action by user needed
47960	I/1	EVENT_H_COVER_NOT_CLOSED Par1: empty (0x0000) Par2: empty (0x0000) Par3: empty (0x0000) Par4: empty (0x0000)	E	-H cover is not closed	Try last action once more (restart sequence)
47961	I/1	EVENT_H_SCIENCE_DATA_GENERATION_STOPPED Par1: EVENT_ID of Cat III error Par2: empty (0x0000) Par3: empty (0x0000) Par4: empty (0x0000)	E	-H science data generation is stopped	Check the occurred event and if possible try to restart the sequence once more
47962	I/1	EVENT_H_DATA_OUTSIDE_OF_RANGE Par1: empty (0x0000) Par2: empty (0x0000) Par3: empty (0x0000) Par4: empty (0x0000)	E	-H raw data outside of nominal range (0...32767 DN)	No action possible
47963	III	EVENT_H_LESS_DATA_THAN_EXPECTED Par1:Expected Nr of H words(MSW) Par2:Expected Nr of H words(LSW) Par3:Received Nr of H words(MSW) Par4:Received Nr of H words(LSW)	E	-H less data received than expected	Stop and restart sequence
47964	III	EVENT_H_DATA_ACQ_TIME_OUT Par1: empty (0x0000) Par2: empty (0x0000) Par3: empty (0x0000) Par4: empty (0x0000)	E	-H data acquisition time out	Stop and restart sequence
47965	I/1	EVENT_H_COOL_STEADY_STATE_FAILURE Par1: cooler mode Par2: Cold tip temperature to be achieved Par3: empty (0x0000) Par4: empty (0x0000)	E	Commanded -H cooler temperature is not equal to the current cold tip temperature in steady state	Stop sequence, start cooling by MTC_Cooler once more, After reaching the steady state start sequence once more
47966	I/1	EVENT_H_CALIBR_SEQ_FINALIZED Par1: empty (0x0000) Par2: empty (0x0000) Par3: empty (0x0000) Par4: empty (0x0000)	E	-H calibration sequence phase (1..6) is finalized	No action by user needed

Event ID	Cat.	Packet Name + Parameter (16bit)	Issue d by	Packet function/Description	Recommended Action by User
47967	I/1	EVENT_H_MODE_NOT_EXPECTED Par1: H-Mode number Par2: empty (0x0000) Par3: empty (0x0000) Par4: empty (0x0000)	E	-H mode number is not expected	TBD
47968	I/2	EVENT_H_IFE_FIFO_CLK_NUMBER_WRONG Par1: empty (0x0000) Par2: empty (0x0000) Par3: empty (0x0000) Par4: empty (0x0000)	E	FIFO VIRTIS-H channel clock number wrong	Stop and restart sequence Due to CAT I/2, switch-off and on the H-PEM and H-Cooler again in order to probably see the event again.
47969	I/1	EVENT_H_IFE_FIFO_EMPTY_FIFO_READ Par1: empty (0x0000) Par2: empty (0x0000) Par3: empty (0x0000) Par4: empty (0x0000)	E	FIFO VIRTIS-H empty FIFO read	Stop and restart sequence
47970	I/1	EVENT_H_IFE_FIFO_RD_ORDER_WRONG Par1: empty (0x0000) Par2: empty (0x0000) Par3: empty (0x0000) Par4: empty (0x0000)	E	FIFO VIRTIS-H read order wrong (MSB and LSB)	Stop and restart sequence
47971	I/1	EVENT_H_ECA_28V_SWITCH_CMD_WRONG Par1: empty (0x0000) Par2: empty (0x0000) Par3: empty (0x0000) Par4: empty (0x0000)	E	VIRTIS-H ECA +28V Switch driver command execution failed	Stop and restart sequence
47972	I/1	EVENT_H_IFE_COMMAND_WRONG Par1: IFE command word to be issued Par2: empty (0x0000) Par3: empty (0x0000) Par4: empty (0x0000)	E	Command transfer to VIRTIS-H failed	Try last action once more, if failed switch off VIRTIS-H
47973	III	EVENT_H_IFE_FIFO_NOT_EMPTY Par1: empty (0x0000) Par2: empty (0x0000) Par3: empty (0x0000) Par4: empty (0x0000)	E	VIRTIS-H IFE FIFO not empty, more data than expected	Send VTC_Enter_Idle_Mode (FIFO reset) and start data acquisition once more
47974	I/1	EVENT_H_DATA_SIZE_TOO_LARGE Par1:Expected Nr of H words(MSW) Par2:Expected Nr of H words(LSW) Par3:Received Nr of H words(MSW) Par4:Received Nr of H words(LSW)	E	VIRTIS-H more data received than expected	Send VTC_Enter_Idle_Mode (FIFO reset) and start data acquisition once more



Event ID	Cat.	Packet Name + Parameter (16bit)	Issue d by	Packet function/Description	Recommended Action by User
47975	I/1	EVENT_H_CCE_28V_SWITCH_CMD_WRONG Par1: empty (0x0000) Par2: empty (0x0000) Par3: empty (0x0000) Par4: empty (0x0000)	E	VIRTIS-H CCE +28V Switch driver command execution failed	Stop and restart sequence
47976	I/1	EVENT_H_IFE_ACCESS_WRONG Par1: empty (0x0000) Par2: empty (0x0000) Par3: empty (0x0000) Par4: empty (0x0000)	E	VIRTIS-H IFE register access failed	Switch off IFE and on once more, if failed switch off VIRTIS-H
47977	IV_H	EVENT_H_PEM_CONNECTION_WRONG Par1: empty (0x0000) Par2: empty (0x0000) Par3: empty (0x0000) Par4: empty (0x0000)	E	VIRTIS-H channel PEM connection wrong	Switch off and once more on the PEM, if failed switch off VIRTIS-H
47978	I/1	EVENT_H_IFE_TEST_PATTERN_WRONG Par1: position wrong pattern LSW Par2: wrong pattern word Par3: empty (0x0000) Par4: empty (0x0000)	E	VIRTIS-H IFE test pattern wrong	Try test pattern check once more, if failed switch off VIRTIS-H channel
47979	III	EVENT_H_IFE_FIFO_FULL Par1: empty (0x0000) Par2: empty (0x0000) Par3: empty (0x0000) Par4: empty (0x0000)	E	FIFO VIRTIS-H overflow	Send VTC_Enter_Idle_Mode (FIFO reset) and start data acquisition once more
47980	III	EVENT_H_IFE_FIFO_EMPTY Par1: empty (0x0000) Par2: empty (0x0000) Par3: empty (0x0000) Par4: empty (0x0000)	E	FIFO VIRTIS-H channel empty	Switch PEM off and on, start data acquisition once more
47981	I/1	EVENT_H_PEM_SHUTTER_OPEN_HK_WRONG Par1: H-HK word 3 (HKRQ_DEVICE_ON) Par2: H-HK word 5 (HKMS_STATUS) Par3: H-HK word25 (HKMS_I_SHUTTER_HEATER) Par4: empty (0x0000)	E	-H shutter open HK are wrong	the H-PEM hardware has to be check
47982	I/1	EVENT_H_PEM_SHUTTER_CLOSE_HK_WRONG Par1: H-HK word 3 (HKRQ_DEVICE_ON) Par2: H-HK word 5 (HKMS_STATUS) Par3: H-HK word25 (HKMS_I_SHUTTER_HEATER) Par4: empty (0x0000)	E	-H shutter close HK are wrong	the H-PEM hardware has to be check



Event ID	Cat.	Packet Name + Parameter (16bit)	Issued by	Packet function/Description	Recommended Action by User
47983	I/1	EVENT_H_SHUTTER_CTRL_TIME_EXCEEDED Par1: H Shutter control time (ms) Par2: empty (0x0000) Par3: empty (0x0000) Par4: empty (0x0000)	E	-H shutter control time exceeded	the H-PEM hardware has to be check
47984	I/1	EVENT_H_CMD_WORD_ERROR Par1: empty (0x0000) Par2: empty (0x0000) Par3: empty (0x0000) Par4: empty (0x0000)	E	VITIS-H channel bad command id or command value out of range	the H-PEM hardware has to be check
47985	I/1	EVENT_H_SHUTTER_NOT_OPEN Par1: empty (0x0000) Par2: empty (0x0000) Par3: empty (0x0000) Par4: empty (0x0000)	E	-H shutter not open	the H-PEM hardware has to be check
47986	I/1	EVENT_H_PEM_HK_OUT_OF_RANGE_IN_CALIBR Par1: Position of wrong H-PEM HK word Par2: empty (0x0000) Par3: empty (0x0000) Par4: empty (0x0000)	E	-H PEM-HK out of range in calibration	the H-PEM hardware has to be check
47987	I/1	EVENT_H_PEM_HK_OUT_OF_RANGE_IN_SCIENCE Par1: Position of wrong H-PEM HK word Par2: empty (0x0000) Par3: empty (0x0000) Par4: empty (0x0000)	E	-H PEM-HK out of range in science mode	the H-PEM hardware has to be check
47988	IX	EVENT_H_CALIBR_SEQ_PHASE_FINALIZED Par1: Number of Phase Par2: empty (0x0000) Par3: empty (0x0000) Par4: empty (0x0000)	E	A -H calibration phase 1, 2, 3 or 4 is finalized 1=Slit_Spectral_Calibration (3 H_IMAGES are transferred) 2=Telescop_Spectral_Calibration (2 H_IMAGES are transferred) 3=Image_Slice_Rad_Calibration (2 H_IMAGES are transferred) 4=Spectrum_Rad_Calibration (2 H_SPECTRA are transferred) 5=H_Simulation_Calibration	

TAB. 9: List of Event report EIDs

TM- 15: (PID51, PC7, T5, ST1, EID47501) Secondary\_Boot\_Completed

Telemetry Packet Information (VIRTIS)			
Packet name	EVENT_SECONDARY_BOOT_COMPLETE	Instrument	VIRTIS
Packet Function	Secondary Boot S/W is successfully started		
Generation Rules	Successful completion of secondary boot		
Header Information			
Process ID	51	Packet Category	7
Service Type	5	Service Subtype	1
Structure ID	N.A.	Packet Length	65
Data Field Information			
Data Field	Field Structure	Remarks	
EID	Unsigned Integer 16 bits (PTC 3, PFC 12)	Event Report Id = 47501	
SW_Version_01	Unsigned Integer 16 bits (PTC 3, PFC 12)	Char 1, 2 of EEPROM S/W version string: "S", "/"	
SW_Version_02	Unsigned Integer 16 bits (PTC 3, PFC 12)	Char 3, 4: "W", "..."	
SW_Version_03	Unsigned Integer 16 bits (PTC 3, PFC 12)	Char 5, 6: "V", "..."	
SW_Version_04	Unsigned Integer 16 bits (PTC 3, PFC 12)	Char 7, 8: "...", "..."	
SW_Version_05	Unsigned Integer 16 bits (PTC 3, PFC 12)	Char 9, 10: "...", "..."	
SW_Version_06	Unsigned Integer 16 bits (PTC 3, PFC 12)	Char 11, 12: "...", "..."	
SW_Version_07	Unsigned Integer 16 bits (PTC 3, PFC 12)	Char 13, 14: "...", "..."	
SW_Version_08	Unsigned Integer 16 bits (PTC 3, PFC 12)	Char 15, 16: "...", "..."	
SW_Version_09	Unsigned Integer 16 bits (PTC 3, PFC 12)	Char 17, 18: "...", "..."	
SW_Version_10	Unsigned Integer 16 bits (PTC 3, PFC 12)	Char 19, 20: "...", "..."	
SW_Version_11	Unsigned Integer 16 bits (PTC 3, PFC 12)	Char 21, 22: "...", "..."	
SW_Version_12	Unsigned Integer 16 bits (PTC 3, PFC 12)	Char 23, 24: "...", "..."	
SW_Version_13	Unsigned Integer 16 bits (PTC 3, PFC 12)	Char 25, 26: "...", "..."	
SW_Version_14	Unsigned Integer 16 bits (PTC 3, PFC 12)	Char 27, 28: "...", "..."	

SW_Version_15	Unsigned Integer 16 bits (PTC 3, PFC 12)	Char 29, 30: “...”, “...”
EEPROM_Start_M	Unsigned Integer 16 bits (PTC 3, PFC 12)	MSW of EEPROM start address
EEPROM_Start_L	Unsigned Integer 16 bits (PTC 3, PFC 12)	LSW of EEPROM start address
EEPROM_End_M	Unsigned Integer 16 bits (PTC 3, PFC 12)	MSW of EEPROM end address
EEPROM_End_L	Unsigned Integer 16 bits (PTC 3, PFC 12)	LSW of EEPROM end address
Enable_HK_Status	Unsigned Integer 16 bits (PTC 3, PFC 12)	BIT 15: Enable HK status (SID1) (0=disabled, 1=enabled) BIT 0..14: always=0
TM_SEQ_COUNTER_PID51_PCAT1	Unsigned Integer 16 bits (PTC 3, PFC 12)	BIT 2..15: sequence counter for PID51, Packet Category1 BIT 0..1: always=0
TM_SEQ_COUNTER_PID51_PCAT4	Unsigned Integer 16 bits (PTC 3, PFC 12)	BIT 2..15: sequence counter for PID51, Packet Category4 BIT 0..1: always=0
TM_SEQ_COUNTER_PID51_PCAT7	Unsigned Integer 16 bits (PTC 3, PFC 12)	BIT 2..15: sequence counter for PID51, Packet Category7 BIT 0..1: always=0
TM_SEQ_COUNTER_PID51_PCAT9	Unsigned Integer 16 bits (PTC 3, PFC 12)	BIT 2..15: sequence counter for PID51, Packet Category9 BIT 0..1: always=0
FAIL_OVER_CAT5	Unsigned Integer 16 bits (PTC 3, PFC 12)	BIT 15: (0=No, 1=Yes) BIT 0..14: always=0
ME_DPU_RESET_CAUSE	Unsigned Integer 16 bits (PTC 3, PFC 12)	BIT 13..15: ME_DPU_RESET_CAUSE due to (0=N/A, 1=ME/DPU +28V (+5V) Power OFF/ON, 2=VIRTUOSO dead lock or Test Display reset, 3=VTC_Enter_Safe_Mode given within a mode, 4=Event generated in a mode, 5=Watch-dog activated in a mode.) BIT 0..12: always=0
ME_DPU_RESET_CAUSE_PARAM	Unsigned Integer 16 bits (PTC 3, PFC 12)	It depends on Reset cause. Cause 0 = N/A value always 0x0000 Cause 1 = N/A value always 0x0000 Cause 2 = N/A; 0x0000 Cause 3 = Active VIRTIS Mode when VTC_Enter_Safe_Mode was commanded Cause 4 = Event ID which caused the reset (i.e. Event CAT V/*) Cause 5 = 1 if TC/MLC acquisition process is blocked, or 2 if TM/SDT transfer process is blocked, or 3=Both, MLC and SDT are blocked

**Notes:**

TM- 16: (PID51, PC7, T5, ST1, EID47502) EVENT\_EEPROM\_STAT

Telemetry Packet Definition (VIRTIS)			
Packet name	EVENT_EEPROM_STAT	Instrument	VIRTIS
Packet Function	Status report of EEPROM content		
Generation Rules	Generated at reception of VTC_Get_EEPROM_Status (192,13)		
Header Information			
Process ID	51	Packet Category	7
Service Type	5	Service Subtype	1
Structure ID	N/A	Packet Length	315
Data Field Information			
Data Field	Field Structure	Remarks	
EID	unsigned (16 bits) (PTC 3, PFC 12)	Value= 47502	
S/W version string 1-2	unsigned (32 bits) (PTC 3, PFC 14)	1 <sup>st</sup> executable S/W version string "S", "/"	
S/W version string 3-4	unsigned (32 bits) (PTC 3, PFC 14)	1 <sup>st</sup> executable S/W version string "W", "..."	
S/W version string 5-6	unsigned (32 bits) (PTC 3, PFC 14)	1 <sup>st</sup> executable S/W version string "V", "..."	
S/W version string 7-8	unsigned (32 bits) (PTC 3, PFC 14)	1 <sup>st</sup> executable S/W version string "...", "..."	
S/W version string 9-10	unsigned (32 bits) (PTC 3, PFC 14)	1 <sup>st</sup> executable S/W version string "...", "..."	
S/W version string 11-12	unsigned (32 bits) (PTC 3, PFC 14)	1 <sup>st</sup> executable S/W version string "...", "..."	
S/W version string 13-14	unsigned (32 bits) (PTC 3, PFC 14)	1 <sup>st</sup> executable S/W version string "...", "..."	
S/W version string 15-16	unsigned (32 bits) (PTC 3, PFC 14)	1 <sup>st</sup> executable S/W version string "...", "..."	
S/W version string 17-18	unsigned (32 bits) (PTC 3, PFC 14)	1 <sup>st</sup> executable S/W version string "...", "..."	
S/W version string 19-20	unsigned (32 bits) (PTC 3, PFC 14)	1 <sup>st</sup> executable S/W version string "...", "..."	
S/W version string 21-22	unsigned (32 bits) (PTC 3, PFC 14)	1 <sup>st</sup> executable S/W version string "...", "..."	
S/W version string 23-24	unsigned (32 bits) (PTC 3, PFC 14)	1 <sup>st</sup> executable S/W version string "...", "..."	
S/W version string 25-26	unsigned (32 bits) (PTC 3, PFC 14)	1 <sup>st</sup> executable S/W version string "...", "..."	
S/W version string 27-28	unsigned (32 bits) (PTC 3, PFC 14)	1 <sup>st</sup> executable S/W version string "...", "..."	
S/W version string 28-29	unsigned (32 bits) (PTC 3, PFC 14)	1 <sup>st</sup> executable S/W version string "...", "\0"	
EEPROM_START_ADDR ESS MSW	unsigned (32 bits) (PTC 3, PFC 14)	1 <sup>st</sup> executable MSW of EEPROM Start address	
EEPROM_START_ADDR ESS LSW	unsigned (32 bits) (PTC 3, PFC 14)	1 <sup>st</sup> executable LSW of EEPROM Start address	
EEPROM_END_ADDR S MSW	unsigned (32 bits) (PTC 3, PFC 14)	1 <sup>st</sup> executable MSW of EEPROM End address	
EEPROM_END_ADDR S LSW	unsigned (32 bits) (PTC 3, PFC 14)	1 <sup>st</sup> executable LSW of EEPROM End address	
S/W version string 1-2	unsigned (32 bits) (PTC 3, PFC 14)	2 <sup>st</sup> executable S/W version string "S", "/"	
S/W version string 3-4	unsigned (32 bits) (PTC 3, PFC 14)	2 <sup>st</sup> executable S/W version string "W", "..."	
S/W version string 5-6	unsigned (32 bits) (PTC 3, PFC 14)	2 <sup>st</sup> executable S/W version string "V", "..."	
S/W version string 7-8	unsigned (32 bits) (PTC 3, PFC 14)	2 <sup>st</sup> executable S/W version string "...", "..."	
S/W version string 9-10	unsigned (32 bits) (PTC 3, PFC 14)	2 <sup>st</sup> executable S/W version string "...", "..."	
S/W version string 11-12	unsigned (32 bits) (PTC 3, PFC 14)	2 <sup>st</sup> executable S/W version string "...", "..."	
S/W version string 13-14	unsigned (32 bits) (PTC 3, PFC 14)	2 <sup>st</sup> executable S/W version string "...", "..."	
S/W version string 15-16	unsigned (32 bits) (PTC 3, PFC 14)	2 <sup>st</sup> executable S/W version string "...", "..."	
S/W version string 17-18	unsigned (32 bits) (PTC 3, PFC 14)	2 <sup>st</sup> executable S/W version string "...", "..."	
S/W version string 19-20	unsigned (32 bits) (PTC 3, PFC 14)	2 <sup>st</sup> executable S/W version string "...", "..."	
S/W version string 21-22	unsigned (32 bits) (PTC 3, PFC 14)	2 <sup>st</sup> executable S/W version string "...", "..."	
S/W version string 23-24	unsigned (32 bits) (PTC 3, PFC 14)	2 <sup>st</sup> executable S/W version string "...", "..."	
S/W version string 25-26	unsigned (32 bits) (PTC 3, PFC 14)	2 <sup>st</sup> executable S/W version string "...", "..."	
S/W version string 27-28	unsigned (32 bits) (PTC 3, PFC 14)	2 <sup>st</sup> executable S/W version string "...", "..."	
S/W version string 28-29	unsigned (32 bits) (PTC 3, PFC 14)	2 <sup>st</sup> executable S/W version string "...", "\0"	
EEPROM_START_ADDR ESS MSW	unsigned (32 bits) (PTC 3, PFC 14)	2 <sup>st</sup> executable MSW of EEPROM Start address	
EEPROM_START_ADDR ESS LSW	unsigned (32 bits) (PTC 3, PFC 14)	2 <sup>st</sup> executable LSW of EEPROM Start address	

EEPROM_END_ADDRESS MSW	unsigned (32 bits) (PTC 3, PFC 14)	2 <sup>st</sup> executable MSW of EEPROM End address
EEPROM_END_ADDRESS LSW	unsigned (32 bits) (PTC 3, PFC 14)	2 <sup>st</sup> executable LSW of EEPROM End address
S/W version string 1-2	unsigned (32 bits) (PTC 3, PFC 14)	3 <sup>st</sup> executable S/W version string "S", "/"
S/W version string 3-4	unsigned (32 bits) (PTC 3, PFC 14)	3 <sup>st</sup> executable S/W version string "W", "..."
S/W version string 5-6	unsigned (32 bits) (PTC 3, PFC 14)	3 <sup>st</sup> executable S/W version string "V", "..."
S/W version string 7-8	unsigned (32 bits) (PTC 3, PFC 14)	3 <sup>st</sup> executable S/W version string "...", "..."
S/W version string 9-10	unsigned (32 bits) (PTC 3, PFC 14)	3 <sup>st</sup> executable S/W version string "...", "..."
S/W version string 11-12	unsigned (32 bits) (PTC 3, PFC 14)	3 <sup>st</sup> executable S/W version string "...", "..."
S/W version string 13-14	unsigned (32 bits) (PTC 3, PFC 14)	3 <sup>st</sup> executable S/W version string "...", "..."
S/W version string 15-16	unsigned (32 bits) (PTC 3, PFC 14)	3 <sup>st</sup> executable S/W version string "...", "..."
S/W version string 17-18	unsigned (32 bits) (PTC 3, PFC 14)	3 <sup>st</sup> executable S/W version string "...", "..."
S/W version string 19-20	unsigned (32 bits) (PTC 3, PFC 14)	3 <sup>st</sup> executable S/W version string "...", "..."
S/W version string 21-22	unsigned (32 bits) (PTC 3, PFC 14)	3 <sup>st</sup> executable S/W version string "...", "..."
S/W version string 23-24	unsigned (32 bits) (PTC 3, PFC 14)	3 <sup>st</sup> executable S/W version string "...", "..."
S/W version string 25-26	unsigned (32 bits) (PTC 3, PFC 14)	3 <sup>st</sup> executable S/W version string "...", "..."
S/W version string 27-28	unsigned (32 bits) (PTC 3, PFC 14)	3 <sup>st</sup> executable S/W version string "...", "..."
S/W version string 28-29	unsigned (32 bits) (PTC 3, PFC 14)	3 <sup>st</sup> executable S/W version string "...", "\0"
EEPROM_START_ADDRESS MSW	unsigned (32 bits) (PTC 3, PFC 14)	3 <sup>st</sup> executable MSW of EEPROM Start address
EEPROM_START_ADDRESS LSW	unsigned (32 bits) (PTC 3, PFC 14)	3 <sup>st</sup> executable LSW of EEPROM Start address
EEPROM_END_ADDRESS MSW	unsigned (32 bits) (PTC 3, PFC 14)	3 <sup>st</sup> executable MSW of EEPROM End address
EEPROM_END_ADDRESS LSW	unsigned (32 bits) (PTC 3, PFC 14)	3 <sup>st</sup> executable LSW of EEPROM End address
S/W version string 1-2	unsigned (32 bits) (PTC 3, PFC 14)	4 <sup>st</sup> executable S/W version string "S", "/"
S/W version string 3-4	unsigned (32 bits) (PTC 3, PFC 14)	4 <sup>st</sup> executable S/W version string "W", "..."
S/W version string 5-6	unsigned (32 bits) (PTC 3, PFC 14)	4 <sup>st</sup> executable S/W version string "V", "..."
S/W version string 7-8	unsigned (32 bits) (PTC 3, PFC 14)	4 <sup>st</sup> executable S/W version string "...", "..."
S/W version string 9-10	unsigned (32 bits) (PTC 3, PFC 14)	4 <sup>st</sup> executable S/W version string "...", "..."
S/W version string 11-12	unsigned (32 bits) (PTC 3, PFC 14)	4 <sup>st</sup> executable S/W version string "...", "..."
S/W version string 13-14	unsigned (32 bits) (PTC 3, PFC 14)	4 <sup>st</sup> executable S/W version string "...", "..."
S/W version string 15-16	unsigned (32 bits) (PTC 3, PFC 14)	4 <sup>st</sup> executable S/W version string "...", "..."
S/W version string 17-18	unsigned (32 bits) (PTC 3, PFC 14)	4 <sup>st</sup> executable S/W version string "...", "..."
S/W version string 19-20	unsigned (32 bits) (PTC 3, PFC 14)	4 <sup>st</sup> executable S/W version string "...", "..."
S/W version string 21-22	unsigned (32 bits) (PTC 3, PFC 14)	4 <sup>st</sup> executable S/W version string "...", "..."
S/W version string 23-24	unsigned (32 bits) (PTC 3, PFC 14)	4 <sup>st</sup> executable S/W version string "...", "..."
S/W version string 25-26	unsigned (32 bits) (PTC 3, PFC 14)	4 <sup>st</sup> executable S/W version string "...", "..."
S/W version string 27-28	unsigned (32 bits) (PTC 3, PFC 14)	4 <sup>st</sup> executable S/W version string "...", "..."
S/W version string 28-29	unsigned (32 bits) (PTC 3, PFC 14)	4 <sup>st</sup> executable S/W version string "...", "\0"
EEPROM_START_ADDRESS MSW	unsigned (32 bits) (PTC 3, PFC 14)	4 <sup>st</sup> executable MSW of EEPROM Start address
EEPROM_START_ADDRESS LSW	unsigned (32 bits) (PTC 3, PFC 14)	4 <sup>st</sup> executable LSW of EEPROM Start address
EEPROM_END_ADDRESS MSW	unsigned (32 bits) (PTC 3, PFC 14)	4 <sup>st</sup> executable MSW of EEPROM End address
EEPROM_END_ADDRESS LSW	unsigned (32 bits) (PTC 3, PFC 14)	4 <sup>st</sup> executable LSW of EEPROM End address
S/W version string 1-2	unsigned (32 bits) (PTC 3, PFC 14)	5 <sup>st</sup> executable S/W version string "S", "/"
S/W version string 3-4	unsigned (32 bits) (PTC 3, PFC 14)	5 <sup>st</sup> executable S/W version string "W", "..."
S/W version string 5-6	unsigned (32 bits) (PTC 3, PFC 14)	5 <sup>st</sup> executable S/W version string "V", "..."
S/W version string 7-8	unsigned (32 bits) (PTC 3, PFC 14)	5 <sup>st</sup> executable S/W version string "...", "..."
S/W version string 9-10	unsigned (32 bits) (PTC 3, PFC 14)	5 <sup>st</sup> executable S/W version string "...", "..."
S/W version string 11-12	unsigned (32 bits) (PTC 3, PFC 14)	5 <sup>st</sup> executable S/W version string "...", "..."
S/W version string 13-14	unsigned (32 bits) (PTC 3, PFC 14)	5 <sup>st</sup> executable S/W version string "...", "..."
S/W version string 15-16	unsigned (32 bits) (PTC 3, PFC 14)	5 <sup>st</sup> executable S/W version string "...", "..."



S/W version string 17-18	unsigned (32 bits) (PTC 3, PFC 14)	5 <sup>st</sup> executable S/W version string "...", "..."
S/W version string 19-20	unsigned (32 bits) (PTC 3, PFC 14)	5 <sup>st</sup> executable S/W version string "...", "..."
S/W version string 21-22	unsigned (32 bits) (PTC 3, PFC 14)	5 <sup>st</sup> executable S/W version string "...", "..."
S/W version string 23-24	unsigned (32 bits) (PTC 3, PFC 14)	5 <sup>st</sup> executable S/W version string "...", "..."
S/W version string 25-26	unsigned (32 bits) (PTC 3, PFC 14)	5 <sup>st</sup> executable S/W version string "...", "..."
S/W version string 27-28	unsigned (32 bits) (PTC 3, PFC 14)	5 <sup>st</sup> executable S/W version string "...", "..."
S/W version string 28-29	unsigned (32 bits) (PTC 3, PFC 14)	5 <sup>st</sup> executable S/W version string "...", "\0"
EEPROM_START_ADDR ESS MSW	unsigned (32 bits) (PTC 3, PFC 14)	5 <sup>st</sup> executable MSW of EEPROM Start address
EEPROM_START_ADDR ESS LSW	unsigned (32 bits) (PTC 3, PFC 14)	5 <sup>st</sup> executable LSW of EEPROM Start address
EEPROM_END_ADDRES S MSW	unsigned (32 bits) (PTC 3, PFC 14)	5 <sup>st</sup> executable MSW of EEPROM End address
EEPROM_END_ADDRES S LSW	unsigned (32 bits) (PTC 3, PFC 14)	5 <sup>st</sup> executable LSW of EEPROM End address
S/W version string 1-2	unsigned (32 bits) (PTC 3, PFC 14)	6 <sup>st</sup> executable S/W version string "S", "/"
S/W version string 3-4	unsigned (32 bits) (PTC 3, PFC 14)	6 <sup>st</sup> executable S/W version string "W", "..."
S/W version string 5-6	unsigned (32 bits) (PTC 3, PFC 14)	6 <sup>st</sup> executable S/W version string "V", "..."
S/W version string 7-8	unsigned (32 bits) (PTC 3, PFC 14)	6 <sup>st</sup> executable S/W version string "...", "..."
S/W version string 9-10	unsigned (32 bits) (PTC 3, PFC 14)	6 <sup>st</sup> executable S/W version string "...", "..."
S/W version string 11-12	unsigned (32 bits) (PTC 3, PFC 14)	6 <sup>st</sup> executable S/W version string "...", "..."
S/W version string 13-14	unsigned (32 bits) (PTC 3, PFC 14)	6 <sup>st</sup> executable S/W version string "...", "..."
S/W version string 15-16	unsigned (32 bits) (PTC 3, PFC 14)	6 <sup>st</sup> executable S/W version string "...", "..."
S/W version string 17-18	unsigned (32 bits) (PTC 3, PFC 14)	6 <sup>st</sup> executable S/W version string "...", "..."
S/W version string 19-20	unsigned (32 bits) (PTC 3, PFC 14)	6 <sup>st</sup> executable S/W version string "...", "..."
S/W version string 21-22	unsigned (32 bits) (PTC 3, PFC 14)	6 <sup>st</sup> executable S/W version string "...", "..."
S/W version string 23-24	unsigned (32 bits) (PTC 3, PFC 14)	6 <sup>st</sup> executable S/W version string "...", "..."
S/W version string 25-26	unsigned (32 bits) (PTC 3, PFC 14)	6 <sup>st</sup> executable S/W version string "...", "..."
S/W version string 27-28	unsigned (32 bits) (PTC 3, PFC 14)	6 <sup>st</sup> executable S/W version string "...", "..."
S/W version string 28-29	unsigned (32 bits) (PTC 3, PFC 14)	6 <sup>st</sup> executable S/W version string "...", "\0"
EEPROM_START_ADDR ESS MSW	unsigned (32 bits) (PTC 3, PFC 14)	6 <sup>st</sup> executable MSW of EEPROM Start address
EEPROM_START_ADDR ESS LSW	unsigned (32 bits) (PTC 3, PFC 14)	6 <sup>st</sup> executable LSW of EEPROM Start address
EEPROM_END_ADDRES S MSW	unsigned (32 bits) (PTC 3, PFC 14)	6 <sup>st</sup> executable MSW of EEPROM End address
EEPROM_END_ADDRES S LSW	unsigned (32 bits) (PTC 3, PFC 14)	6 <sup>st</sup> executable LSW of EEPROM End address
S/W version string 1-2	unsigned (32 bits) (PTC 3, PFC 14)	7 <sup>st</sup> executable S/W version string "S", "/"
S/W version string 3-4	unsigned (32 bits) (PTC 3, PFC 14)	7 <sup>st</sup> executable S/W version string "W", "..."
S/W version string 5-6	unsigned (32 bits) (PTC 3, PFC 14)	7 <sup>st</sup> executable S/W version string "V", "..."
S/W version string 7-8	unsigned (32 bits) (PTC 3, PFC 14)	7 <sup>st</sup> executable S/W version string "...", "..."
S/W version string 9-10	unsigned (32 bits) (PTC 3, PFC 14)	7 <sup>st</sup> executable S/W version string "...", "..."
S/W version string 11-12	unsigned (32 bits) (PTC 3, PFC 14)	7 <sup>st</sup> executable S/W version string "...", "..."
S/W version string 13-14	unsigned (32 bits) (PTC 3, PFC 14)	7 <sup>st</sup> executable S/W version string "...", "..."
S/W version string 15-16	unsigned (32 bits) (PTC 3, PFC 14)	7 <sup>st</sup> executable S/W version string "...", "..."
S/W version string 17-18	unsigned (32 bits) (PTC 3, PFC 14)	7 <sup>st</sup> executable S/W version string "...", "..."
S/W version string 19-20	unsigned (32 bits) (PTC 3, PFC 14)	7 <sup>st</sup> executable S/W version string "...", "..."
S/W version string 21-22	unsigned (32 bits) (PTC 3, PFC 14)	7 <sup>st</sup> executable S/W version string "...", "..."
S/W version string 23-24	unsigned (32 bits) (PTC 3, PFC 14)	7 <sup>st</sup> executable S/W version string "...", "..."
S/W version string 25-26	unsigned (32 bits) (PTC 3, PFC 14)	7 <sup>st</sup> executable S/W version string "...", "..."
S/W version string 27-28	unsigned (32 bits) (PTC 3, PFC 14)	7 <sup>st</sup> executable S/W version string "...", "..."
S/W version string 28-29	unsigned (32 bits) (PTC 3, PFC 14)	7 <sup>st</sup> executable S/W version string "...", "\0"
EEPROM_START_ADDR ESS MSW	unsigned (32 bits) (PTC 3, PFC 14)	7 <sup>st</sup> executable MSW of EEPROM Start address
EEPROM_START_ADDR ESS LSW	unsigned (32 bits) (PTC 3, PFC 14)	7 <sup>st</sup> executable LSW of EEPROM Start address

EEPROM_END_ADDRESS MSW	unsigned (32 bits) (PTC 3, PFC 14)	7 <sup>st</sup> executable MSW of EEPROM End address
EEPROM_END_ADDRESS LSW	unsigned (32 bits) (PTC 3, PFC 14)	7 <sup>st</sup> executable LSW of EEPROM End address
S/W version string 1-2	unsigned (32 bits) (PTC 3, PFC 14)	8 <sup>st</sup> executable S/W version string "S", "/"
S/W version string 3-4	unsigned (32 bits) (PTC 3, PFC 14)	8 <sup>st</sup> executable S/W version string "W", "..."
S/W version string 5-6	unsigned (32 bits) (PTC 3, PFC 14)	8 <sup>st</sup> executable S/W version string "V", "..."
S/W version string 7-8	unsigned (32 bits) (PTC 3, PFC 14)	8 <sup>st</sup> executable S/W version string "...", "..."
S/W version string 9-10	unsigned (32 bits) (PTC 3, PFC 14)	8 <sup>st</sup> executable S/W version string "...", "..."
S/W version string 11-12	unsigned (32 bits) (PTC 3, PFC 14)	8 <sup>st</sup> executable S/W version string "...", "..."
S/W version string 13-14	unsigned (32 bits) (PTC 3, PFC 14)	8 <sup>st</sup> executable S/W version string "...", "..."
S/W version string 15-16	unsigned (32 bits) (PTC 3, PFC 14)	8 <sup>st</sup> executable S/W version string "...", "..."
S/W version string 17-18	unsigned (32 bits) (PTC 3, PFC 14)	8 <sup>st</sup> executable S/W version string "...", "..."
S/W version string 19-20	unsigned (32 bits) (PTC 3, PFC 14)	8 <sup>st</sup> executable S/W version string "...", "..."
S/W version string 21-22	unsigned (32 bits) (PTC 3, PFC 14)	8 <sup>st</sup> executable S/W version string "...", "..."
S/W version string 23-24	unsigned (32 bits) (PTC 3, PFC 14)	8 <sup>st</sup> executable S/W version string "...", "..."
S/W version string 25-26	unsigned (32 bits) (PTC 3, PFC 14)	8 <sup>st</sup> executable S/W version string "...", "..."
S/W version string 27-28	unsigned (32 bits) (PTC 3, PFC 14)	8 <sup>st</sup> executable S/W version string "...", "..."
S/W version string 28-29	unsigned (32 bits) (PTC 3, PFC 14)	8 <sup>st</sup> executable S/W version string "...", "\0"
EEPROM_START_ADDRESS MSW	unsigned (32 bits) (PTC 3, PFC 14)	8 <sup>st</sup> executable MSW of EEPROM Start address
EEPROM_START_ADDRESS LSW	unsigned (32 bits) (PTC 3, PFC 14)	8 <sup>st</sup> executable LSW of EEPROM Start address
EEPROM_END_ADDRESS MSW	unsigned (32 bits) (PTC 3, PFC 14)	8 <sup>st</sup> executable MSW of EEPROM End address
EEPROM_END_ADDRESS LSW	unsigned (32 bits) (PTC 3, PFC 14)	8 <sup>st</sup> executable LSW of EEPROM End address
<b>Notes:</b>		

TM- 17: (PID51, PC7, T5, ST1, EID47701) EVENT\_M\_DUMP\_DATA\_PRODUCTION\_PARAMETER

Telemetry Packet Information (VIRTIS)			
Packet name	EVENT_M_DUMP_DATA_PRODUCTION_PARAMETER	Instrument	VIRTIS
Packet Function	Dump the V-M Data Production Parameter Set		
Generation Rules	Upon reception of Enable_Science_HS_Link		
Header Information			
Process ID	51	Packet Category	7
Service Type	5	Service Subtype	1
Structure ID	N.A.	Packet Length	13
Data Field Information			
Data Field	Field Structure	Remarks	
EID	Unsigned Integer 16 bits (PTC 3, PFC 12)	Event Report Id = 47701	
M_DPT	Enumerated Parameter 16 bits (PTC 2, PFC 16)	BIT 14..15: Data Production Type: specifies the type of M session to be performed after the start given with the Enable Science 0=M_Data_Science 1=M_Data_Calibration 2=M_Data_Test BIT 0..13: Always 0	
<b>Notes:</b>			



TM- 18: (PID51, PC7, T5, ST1, EID47702) EVENT\_M\_DUMP\_FUNCTIONAL\_PARAMETER

Telemetry Packet Information (VIRTIS)			
Packet name	EVENT_M_DUMP_FUNCTIONAL_PARAMETER		Instrument   VIRTIS
Packet Function	Dump the V-M Functional Parameter Set		
Generation Rules	Upon reception of Enable_Science_HS_Link		
Header Information			
Process ID	51	Packet Category	7
Service Type	5	Service Subtype	1
Structure ID	N.A.	Packet Length	69
Data Field Information			
Data Field	Field Structure	Remarks	
EID	Unsigned Integer 16 bits (PTC 3, PFC 12)	Event Report Id = 47702	
M_IR_WIN_X1	Unsigned Integer 16 bits (PTC 3, PFC 12)	BIT 7..15: X-coordinate of the IR first pixel $a_d=1$ $b_d=0$ unit=pixel BIT 0..6: always 0	
M_IR_WIN_X2	Unsigned Integer 16 bits (PTC 3, PFC 12)	BIT 7..15: X-coordinate of the IR last pixel $a_d=1$ $b_d=0$ unit=pixel BIT 0..6: always 0	
M_IR_WIN_Y1	Unsigned Integer 16 bits (PTC 3, PFC 12)	BIT 7..15: Y-coordinate of the IR first pixel $a_d=1$ $b_d=0$ unit=pixel BIT 0..6: always 0	
M_IR_WIN_Y2	Unsigned Integer 16 bits (PTC 3, PFC 12)	BIT 7..15: Y-coordinate of the IR last pixel $a_d=1$ $b_d=0$ unit=pixel BIT 0..6: always 0	
M_IR_VDETCOM	Unsigned Integer 16 bits (PTC 3, PFC 12)	BIT 4..15: VDETCOM bias voltage $a_d=4.875E-04$ $b_d=2.0119E+00$ unit=Volt BIT 0..3: always 0	
M_IR_VDETADJ	Unsigned Integer 16 bits (PTC 3, PFC 12)	BIT 4..15: VDETADJ bias voltage $a_d=1.22E-03$ $b_d=3E-04$ unit= Volt BIT 0..3: always 0	
M_IR_DELAY	Unsigned Integer 16 bits (PTC 3, PFC 12)	BIT 6..15: IR delay time (EM) $a_d=1.0E-01$ $b_d=0$ unit=sec (FM) $a_d=2.0E-02$ $b_d=0$ unit=sec BIT 0..5: always 0	
M_IR_EXPO	Unsigned Integer 16 bits (PTC 3, PFC 12)	BIT 6..15: IR exposure time (EM) $a_d=1.0E-01$ $b_d=0$ unit=sec (FM) $a_d=2.0E-02$ $b_d=0$ unit=sec BIT 0..5: always 0	
M_CCD_WIN_X1	Unsigned Integer 16 bits (PTC 3, PFC 12)	BIT 7..15: X-coordinate of CCD first pixel $a_d=1$ $b_d=0$ unit=pixel BIT 0..6: always 0	
M_CCD_WIN_X2	Unsigned Integer 16 bits (PTC 3, PFC 12)	BIT 7..15: X-coordinate of CCD last pixel $a_d=1$ $b_d=0$ unit=pixel BIT 0..6: always 0	
M_CCD_WIN_Y1	Unsigned Integer 16 bits (PTC 3, PFC 12)	BIT 8..15: Y-coordinate of CCD first pixel $a_d=1$ $b_d=0$ unit=pixel BIT 0..7: always 0	
M_CCD_WIN_Y2	Unsigned Integer 16 bits (PTC 3, PFC 12)	BIT 8..15: Y-coordinate of CDD last pixel $a_d=1$ $b_d=0$ unit=pixel BIT 0..7: always 0	
M_CCD_DELAY	Unsigned Integer 16 bits (PTC 3, PFC 12)	BIT 6..15: CCD delay time (EM) $a_d=1.0E-01$ $b_d=0$ unit=sec (FM) $a_d=2.0E-02$ $b_d=0$ unit=sec BIT 0..5: always 0	

M_CCD_EXPO	Unsigned Integer 16 bits (PTC 3, PFC 12)	BIT 6..15: CCD exposure time (EM) $a_d=1.0E-01$ $b_d=0$ unit=sec (FM) $a_d=2.0E-02$ $b_d=0$ unit=sec BIT 0..5: always 0
M_SU	Enumerated Parameter 16 bits (PTC 2, PFC 16)	<b>For FM:</b> BIT 14..15: scan mirror mode 0=Point 1=Scan 2=Off BIT 0..13: always 0 <b>For EM:</b> BIT 14..15: scan mirror mode 0=Point 1=Scan 2=Off BIT 0..13: always 0
M_α <sub>first</sub>	Unsigned Integer 16 bits (PTC 3, PFC 12)	BIT 0..15: if SU mode = scan, first angle $a_d=1.0986E-03$ $b_d=-3.60E+01$ unit=deg (el angle) if SU mode = point, pointed angle $a_d=1.0986E-03$ $b_d=-3.60E+01$ unit=deg (el angle)
M_α <sub>last</sub>	Unsigned Integer 16 bits (PTC 3, PFC 12)	BIT 0..15: if SU mode = point, don't care if SU mode = scan, last angle $a_d=1.0986E-03$ $b_d=-3.60E+01$ unit=deg (el angle)
M_Δα	Unsigned Integer 16 bits (PTC 3, PFC 12)	BIT 0..15: if SU mode = point, don't care if SU mode = scan, scan step size, $a_d=1.0986E-03$ $b_d=0$ unit=deg (el angle)
M_Nα <sub>IRT</sub>	Unsigned Integer 16 bits (PTC 3, PFC 12)	BIT 0..15: if SU mode = point, don't care if SU mode =scan,# of IRT with the same angle, $a_d=1$ $b_d=0$ unit= frame
M_D/BCK_RATE	Unsigned Integer 16 bits (PTC 3, PFC 12)	BIT 0..15: dark acquisition rate number $a_d=1$ $b_d=0$ unit=frame
M_SHUTT_CURR	Unsigned Integer 16 bits (PTC 3, PFC 12)	BIT 12..15: shutter current (FM) $a_d=1$ $b_d=45$ unit=mA (EM) $a_d=1$ $b_d=41$ unit=mA BIT 0..11: always 0
M_SHUTT_STAB	Unsigned Integer 16 bits (PTC 3, PFC 12)	BIT 8..15: shutter stab time $a_d=1$ $b_d=0$ unit=ms BIT 0..7: always 0
M_ANN_LIMITS	Unsigned Integer 16 bits (PTC 3, PFC 12)	BIT 10..15: Annealing temperature limits $a_d=-8.10E-01$ $b_d=3.80E+01$ unit=°C BIT 0..9: always 0
M_ANN_T_OUT	Unsigned Integer 16 bits (PTC 3, PFC 12)	BIT 6..15: Annealing timeout $a_d=1$ $b_d=0$ unit=min BIT 0..5: always 0
M_ECA_ACT	Unsigned Integer 16 bits (PTC 3, PFC 12)	BIT 8..15: ECA actuation time $a_d=1$ $b_d=0$ unit=min BIT 0..7: always 0

OPEN_COVER_STEPS	Unsigned Integer 16 bits (PTC 3, PFC 12)	BIT 9..15: # steps for cover open $a_d=1$ $b_d=0$ unit=step BIT 0..8: always 0
M_IR_DET_OFF	Unsigned Integer 16 bits (PTC 3, PFC 12)	BIT 0..15: IR detector On/Off modality 0x00FF means the M-IR detector is <u>not</u> switch-on (in – M data acquisition modes) otherwise it is switched-on
CLOSE_COVER_STEPS	Unsigned Integer 16 bits (PTC 3, PFC 12)	BIT 9..15: # steps for cover close $a_d=1$ $b_d=0$ unit=step BIT 0..8: always 0
INIT_COVER_STEPS	Unsigned Integer 16 bits (PTC 3, PFC 12)	BIT 9..15: # steps for cover init $a_d=$ $b_d=$ unit= BIT 0..8: always 0

**Notes:**

The  $a_d$  and  $b_d$  coefficients are referred to the following transfer function

TF:  $Y = a_d * X_{ADU} + b_d$

TM- 19: (PID51, PC7, T5, ST1, EID47703) EVENT\_M\_DUMP\_OPERATIONAL\_PARAMETER

Telemetry Packet Information (VIRTIS)		
Packet name	EVENT_M_DUMP_OPERATIONAL_PARAMETER	Instrument VIRTIS
Packet Function	Dump the V-M Operative Parameter Set	
Generation Rules	Upon reception of Enable_Science_HS_Link	
Header Information		
Process ID	51	Packet Category 7
Service Type	5	Service Subtype 1
Structure ID	N.A.	Packet Length 19
Data Field Information		
Data Field	Field Structure	Remarks
EID	Unsigned Integer 16 bits (PTC 3, PFC 12)	Event Report Id = 47703
M_ERT	Enumerated Parameter 16 bits (PTC 2, PFC 16)	<p><b>For FM :</b>            BIT 13..15 : External Repetition Time i.e. the repetition time of a Composite Acquisition Cycle            0=5sec            1=20sec            2=60sec            3=300sec            4=2.5sec            5=10sec            BIT 0..12= always 0</p> <p><b>For EM :</b>            BIT 12..15 : External Repetition Time i.e. the repetition time of a Composite Acquisition Cycle            0=5sec            1=20sec            2=60sec            3=300sec            BIT 0..13= always 0</p>
M_SS	Unsigned Integer 16 bits (PTC 3, PFC 12)	BIT 14..15 : Slice Summing $a_d=1$ $b_d=0$ unit=slice BIT 0..13= always 0
M_ACQ_MODE	Enumerated Parameter 16 bits (PTC 2, PFC 16)	BIT 13..15: Acquisition Mode 0=nominal (3x4, full window) 1=VIS only (1x4) 2=IR only (1x4) 3=high spectral (1x4, full window) 4=high spatial (3x1, full window) 5=all_pix (no binning, full window) 6=Reduced Slit (3x1) 7=Alternate (IR only, 1x4) BIT 0..12= always 0
M_COMPR	Enumerated Parameter 16 bits (PTC 2, PFC 16)	BIT 13..15 0=no compression 1=lossless 2=wavelet 2 bit/datum 3 =wavelet 1.5 bit/datum 4=wavelet 1 bit/datum BIT 0..12= always 0
<b>Notes:</b>		

TM- 20: (PID51, PC7, T5, ST1, EID47704) EVENT\_M\_DUMP\_ALTERNATE\_PARAMETER

Telemetry Packet Information (VIRTIS)			
Packet name	EVENT_M_DUMP_ALTERNATE_PARAMETER	Instrument	VIRTIS
Packet Function	Dump the V-M Alternate Parameter Set		
Generation Rules	Upon reception of Enable_Science_HS_Link		
Header Information			
Process ID	51	Packet Category	7
Service Type	5	Service Subtype	1
Structure ID	N.A.	Packet Length	23
Data Field Information			
Data Field	Field Structure	Remarks	
EID	Unsigned Integer 16 bits (PTC 3, PFC 12)	Event Report Id = 47704	
M_IR_WIN_X1	Unsigned Integer 16 bits (PTC 3, PFC 12)	BIT 7..15: X-coordinate of the IR first pixel $a_d=1$ $b_d=0$ unit=pixel BIT 0..6: always 0	
M_IR_WIN_X2	Unsigned Integer 16 bits (PTC 3, PFC 12)	BIT 7..15: X-coordinate of the IR first pixel $a_d=1$ $b_d=0$ unit=pixel BIT 0..6: always 0	
M_IR_WIN_Y1	Unsigned Integer 16 bits (PTC 3, PFC 12)	BIT 7..15: X-coordinate of the IR first pixel $a_d=1$ $b_d=0$ unit=pixel BIT 0..6: always 0	
M_IR_WIN_Y2	Unsigned Integer 16 bits (PTC 3, PFC 12)	BIT 7..15: X-coordinate of the IR first pixel $a_d=1$ $b_d=0$ unit=pixel BIT 0..6: always 0	
M_IR_DELAY	Unsigned Integer 16 bits (PTC 3, PFC 12)	BIT 6..15: IR delay time (EM) $a_d=1.0E-01$ $b_d=0$ unit=sec (FM) $a_d=2.0E-02$ $b_d=0$ unit=sec BIT 0..5: always 0	
M_IR_EXPO	Unsigned Integer 16 bits (PTC 3, PFC 12)	BIT 6..15: IR exposure time (EM) $a_d=1.0E-01$ $b_d=0$ unit=sec (FM) $a_d=2.0E-02$ $b_d=0$ unit=sec BIT 0..5: always 0	
<b>Notes:</b>			
The $a_d$ and $b_d$ coefficients are referred to the following transfer function			
TF: $Y = a_d * X_{ADU} + b_d$			

TM- 21: (PID51, PC7, T5, ST1, EID47705) EVENT\_M\_DUMP\_CALIBRATION\_PARAMETER

Telemetry Packet Information (VIRTIS)			
Packet name	EVENT_M_DUMP_CALIBRATION_PARAMETER		Instrument VIRTIS
Packet Function	Dump the V-M Calibration Parameter Set		
Generation Rules	Upon reception of Enable_Science_HS_Link		
Header Information			
Process ID	51	Packet Category	7
Service Type	5	Service Subtype	1
Structure ID	N.A.	Packet Length	67
Data Field Information			
Data Field	Field Structure	Remarks	
EID	Unsigned Integer 16 bits (PTC 3, PFC 12)	Event Report Id = 47705	
M_IR_DELAY1	Unsigned Integer 16 bits (PTC 3, PFC 12)	BIT 6..15: IR delay time phase 1 (EM) $a_d= 1.0E-01$ $b_d=0$ unit=sec (FM) $a_d= 2.0E-02$ $b_d=0$ unit=sec BIT 0..5: always 0	
M_IR_DELAY2	Unsigned Integer 16 bits (PTC 3, PFC 12)	BIT 6..15: IR delay time phase 2 (EM) $a_d= 1.0E-01$ $b_d=0$ unit=sec (FM) $a_d= 2.0E-02$ $b_d=0$ unit=sec BIT 0..5: always 0	
M_IR_DELAY3	Unsigned Integer 16 bits (PTC 3, PFC 12)	BIT 6..15: IR delay time phase 3 (EM) $a_d= 1.0E-01$ $b_d=0$ unit=sec (FM) $a_d= 2.0E-02$ $b_d=0$ unit=sec BIT 0..5: always 0	
M_IR_DELAY4	Unsigned Integer 16 bits (PTC 3, PFC 12)	BIT 6..15: IR delay time phase 4 (EM) $a_d= 1.0E-01$ $b_d=0$ unit=sec (FM) $a_d= 2.0E-02$ $b_d=0$ unit=sec BIT 0..5: always 0	
M_IR_DELAY5	Unsigned Integer 16 bits (PTC 3, PFC 12)	BIT 6..15: IR delay time phase 5 (EM) $a_d= 1.0E-01$ $b_d=0$ unit=sec (FM) $a_d= 2.0E-02$ $b_d=0$ unit=sec BIT 0..5: always 0	
M_IR_DELAY6	Unsigned Integer 16 bits (PTC 3, PFC 12)	BIT 6..15: IR delay time phase 6 (EM) $a_d= 1.0E-01$ $b_d=0$ unit=sec (FM) $a_d= 2.0E-02$ $b_d=0$ unit=sec BIT 0..5: always 0	
M_IR_EXPO1	Unsigned Integer 16 bits (PTC 3, PFC 12)	BIT 6..15: IR exposure time phase 1 (EM) $a_d= 1.0E-01$ $b_d=0$ unit=sec (FM) $a_d= 2.0E-02$ $b_d=0$ unit=sec BIT 0..5: always 0	
M_IR_EXPO2	Unsigned Integer 16 bits (PTC 3, PFC 12)	BIT 6..15: IR exposure time phase 2 (EM) $a_d= 1.0E-01$ $b_d=0$ unit=sec (FM) $a_d= 2.0E-02$ $b_d=0$ unit=sec BIT 0..5: always 0	
M_IR_EXPO3	Unsigned Integer 16 bits (PTC 3, PFC 12)	BIT 6..15: IR exposure time phase 3 (EM) $a_d= 1.0E-01$ $b_d=0$ unit=sec (FM) $a_d= 2.0E-02$ $b_d=0$ unit=sec BIT 0..5: always 0	
M_IR_EXPO4	Unsigned Integer 16 bits (PTC 3, PFC 12)	BIT 6..15: IR exposure time phase 4 (EM) $a_d= 1.0E-01$ $b_d=0$ unit=sec (FM) $a_d= 2.0E-02$ $b_d=0$ unit=sec BIT 0..5: always 0	

M_IR_EXPO5	Unsigned Integer 16 bits (PTC 3, PFC 12)	BIT 6..15: IR exposure time phase 5 (EM) $a_d= 1.0E-01$ $b_d=0$ unit=sec (FM) $a_d= 2.0E-02$ $b_d=0$ unit=sec BIT 0..5: always 0
M_IR_EXPO6	Unsigned Integer 16 bits (PTC 3, PFC 12)	BIT 6..15: IR exposure time phase 5 (EM) $a_d= 1.0E-01$ $b_d=0$ unit=sec (FM) $a_d= 2.0E-02$ $b_d=0$ unit=sec BIT 0..5: always 0
M_IR_L_STAB	Unsigned Integer 16 bits (PTC 3, PFC 12)	BIT 8..15: IR lamp stabilization time $a_d= 1.00E-01$ $b_d=0$ unit= sec BIT 0..7: always 0
M_IR_L_CURR	Enumerated Parameter 16 bits (PTC 2, PFC 16)	BIT 12..15: IR lamp current (FM) $a_d= 1.00E-01$ $b_d=94$ unit= mA (EM) $a_d= 1.00E-01$ $b_d=194$ unit= mA BIT 0..11: always 0
M_CCD_DELAY1	Unsigned Integer 16 bits (PTC 3, PFC 12)	BIT 6..15: CCD delay time phase 1 (EM) $a_d= 1.0E-01$ $b_d=0$ unit=sec (FM) $a_d= 2.0E-02$ $b_d=0$ unit=sec BIT 0..5: always 0
M_CCD_DELAY2	Unsigned Integer 16 bits (PTC 3, PFC 12)	BIT 6..15: CCD delay time phase 2 (EM) $a_d= 1.0E-01$ $b_d=0$ unit=sec (FM) $a_d= 2.0E-02$ $b_d=0$ unit=sec BIT 0..5: always 0
M_CCD_DELAY3	Unsigned Integer 16 bits (PTC 3, PFC 12)	BIT 6..15: CCD delay time phase 3 (EM) $a_d= 1.0E-01$ $b_d=0$ unit=sec (FM) $a_d= 2.0E-02$ $b_d=0$ unit=sec BIT 0..5: always 0
M_CCD_DELAY4	Unsigned Integer 16 bits (PTC 3, PFC 12)	BIT 6..15: CCD delay time phase 4 (EM) $a_d= 1.0E-01$ $b_d=0$ unit=sec (FM) $a_d= 2.0E-02$ $b_d=0$ unit=sec BIT 0..5: always 0
M_CCD_DELAY5	Unsigned Integer 16 bits (PTC 3, PFC 12)	BIT 6..15: CCD delay time phase 5 (EM) $a_d= 1.0E-01$ $b_d=0$ unit=sec (FM) $a_d= 2.0E-02$ $b_d=0$ unit=sec BIT 0..5: always 0
M_CCD_DELAY6	Unsigned Integer 16 bits (PTC 3, PFC 12)	BIT 6..15: CCD delay time phase 6 (EM) $a_d= 1.0E-01$ $b_d=0$ unit=sec (FM) $a_d= 2.0E-02$ $b_d=0$ unit=sec BIT 0..5: always 0
M_CCD_EXPO1	Unsigned Integer 16 bits (PTC 3, PFC 12)	BIT 6..15: CCD exposure time phase 1 (EM) $a_d= 1.0E-01$ $b_d=0$ unit=sec (FM) $a_d= 2.0E-02$ $b_d=0$ unit=sec BIT 0..5: always 0
M_CCD_EXPO2	Unsigned Integer 16 bits (PTC 3, PFC 12)	BIT 6..15: CCD exposure time phase 2 (EM) $a_d= 1.0E-01$ $b_d=0$ unit=sec (FM) $a_d= 2.0E-02$ $b_d=0$ unit=sec BIT 0..5: always 0
M_CCD_EXPO3	Unsigned Integer 16 bits (PTC 3, PFC 12)	BIT 6..15: CCD exposure time phase 3 (EM) $a_d= 1.0E-01$ $b_d=0$ unit=sec (FM) $a_d= 2.0E-02$ $b_d=0$ unit=sec BIT 0..5: always 0
M_CCD_EXPO4	Unsigned Integer 16 bits (PTC 3, PFC 12)	BIT 6..15: CCD exposure time phase 4 (EM) $a_d= 1.0E-01$ $b_d=0$ unit=sec (FM) $a_d= 2.0E-02$ $b_d=0$ unit=sec BIT 0..5: always 0
M_CCD_EXPO5	Unsigned Integer 16 bits (PTC 3, PFC 12)	BIT 6..15: CCD exposure time phase 5 (EM) $a_d= 1.0E-01$ $b_d=0$ unit=sec (FM) $a_d= 2.0E-02$ $b_d=0$ unit=sec BIT 0..5: always 0

M_CCD_EXPO6	Unsigned Integer 16 bits (PTC 3, PFC 12)	BIT 6..15: CCD exposure time phase 5 (EM) $a_d= 1.0E-01$ $b_d=0$ unit=sec (FM) $a_d= 2.0E-02$ $b_d=0$ unit=sec BIT 0..5: always 0
M_CCD_L_STAB	Unsigned Integer 16 bits (PTC 3, PFC 12)	BIT 8..15: CCD lamp stabilization time $a_d= 1.00E-01$ $b_d=0$ unit= sec BIT 0..7: always 0
M_CCD_L_CURR	Enumerated Parameter 16 bits (PTC 2, PFC 16)	BIT 12..15: CCD lamp current 0=240mA 1=244mA 2=250mA 3=255mA BIT 0..11: always 0

**Notes:**

The  $a_d$  and  $b_d$  coefficients are referred to the following transfer function

TF:  $Y = a_d * X_{ADU} + b_d$



TM- 22: (PID51, PC7, T5, ST1, EID47901) H\_Dump\_Data\_Production\_Parameter

<b>Telecommand Packet Information (VIRTIS)</b>			
Packet name	H_Dump_Data_Production_Parameter	Instrument	VIRTIS
Packet Function	Dump the H_Data_Production_Mode		
Generation Rules	Upon reception of HTC_Change_Data_Product_Param_RAM or HTC_Change_Data_Product_Param_RAM_EEPROM		
<b>Header Information</b>			
Process ID	51	Packet Category	7
Service Type	5	Service Subtype	1
Structure ID	N.A.	Packet Length	13
<b>Data Field Information</b>			
Data Field	Field Structure	Remarks	
EID	Unsigned Integer 16 bits (PTC 3, PFC 12)	Event Report Id = 47901	
H_Data_Production Mode (for calibration modes only)	Unsigned Integer 16 bits (PTC 3, PFC 12)	BIT 12..15 Data Production Type: specifies the type of H session to be performed after the start given with the Enable Science 0 = H_Nominal_Observation 1 = DELETED 2 = H_Calibration 3 = H_Nominal_Simulation 4 = DELETED 5 = DELETED 6 = DELETED 7 = H_Spectral_Calibration_Simulation 8 = H_Science_Backup 9 = H_Test BIT 0..5: always 0	
Notes:			

TM- 23: (PID51, PC7, T5, ST1, EID47902) H\_Dump\_Functional\_Parameter

Telecommand Packet Information (VIRTIS)			
Packet name	H_Dump_Functional_Parameter	Instrument	VIRTIS
Packet Function	Dump the H Functional Parameter Set		
Generation Rules	Upon reception of HTC_Change_Func_Param_RAM or HTC_Change_Func_Param_RAM_EEPROM		
Header Information			
Process ID	51	Packet Category	7
Service Type	5	Service Subtype	1
Structure ID	N.A.	Packet Length	61
Data Field Information			
Data Field	Field Structure	Remarks	
EID	Unsigned Integer 16 bits (PTC 3, PFC 12)	Event Report Id = 47902	
H_Int_Spect_T_Num1	Unsigned Integer 16 bits (PTC 3, PFC 12)	BIT 6..15 = LSB of integration time for Telescope Spectral Calibration BIT 0..5 = always 0 Integration time = Integration time LSW + Integration time MSW * 1024) * 512 10 <sup>-6</sup> unit=sec	
H_Int_Spect_T_Num2	Unsigned Integer 16 bits (PTC 3, PFC 12)	BIT 8..15 = MSB of integration time for Telescope Spectral Calibration BIT 0..7 = always 0	
H_Int_Spect_S_Num1	Unsigned Integer 16 bits (PTC 3, PFC 12)	BIT 6..15 = LSB of integration time for Slit Spectral Calibration BIT 0..5 = always 0 Integration time = Integration time LSW + Integration time MSW * 1024) * 512 10 <sup>-6</sup> unit=sec	
H_Int_Spect_S_Num2	Unsigned Integer 16 bits (PTC 3, PFC 12)	BIT 8..15 = MSB of integration time for Slit Spectral Calibration BIT 0..7 = always 0	
H_Int_Rad_Num1	Unsigned Integer 16 bits (PTC 3, PFC 12)	BIT 6..15 = LSB of integration time for radiometric Calibration BIT 0..5 = always 0 Integration time = Integration time LSW + Integration time MSW * 1024) * 512 10 <sup>-6</sup> unit=sec	
H_Int_Rad_Num2	Unsigned Integer 16 bits (PTC 3, PFC 12)	BIT 8..15 = MSB of integration time for radiometric Calibration BIT 0..7 = always 0	
H_V_Bias	Unsigned Integer 16 bits (PTC 3, PFC 12)	BIT 8..15 = Detector bias a <sub>d</sub> = 0.0146      b <sub>d</sub> =-0.001      unit=Volt BIT 0..7 = always 0	
H_I_Lamp_Spect_T	Unsigned Integer 16 bits (PTC 3, PFC 12)	BIT 8..15 = Telescope Spectral Calibration lamp required current a <sub>d</sub> = 0.09046      b <sub>d</sub> =+0.005      unit=mA BIT 0..7 = always 0	
H_I_Lamp_Spect_S	Unsigned Integer 16 bits (PTC 3, PFC 12)	BIT 8..15 = Slit Spectral Calibration lamp required current a <sub>d</sub> = 0.09046      b <sub>d</sub> =+0.005      unit=mA BIT 0..7 = always 0	
H_I_Lamp_Radio	Unsigned Integer 16 bits (PTC 3, PFC 12)	BIT 8..15 = radiometric Calibration lamp required current a <sub>d</sub> = 0.09046      b <sub>d</sub> =+0.005      unit=mA BIT 0..7 = always 0	

H_I_Shutter	Unsigned Integer 16 bits (PTC 3, PFC 12)	BIT 8..15 = Shutter required current $a_d= 5.031E-01$ $b_d=0$ unit=mA BIT 0..7 = always 0
H_Stab_Lamp_Time	Unsigned Integer 16 bits (PTC 3, PFC 12)	BIT 8..15 = Time needed to stabilize the lamps $a_d= 10$ $b_d=0$ unit=ms BIT 0..7 = always 0
H_Stab_Det_Time	Unsigned Integer 16 bits (PTC 3, PFC 12)	BIT 9..15 = Time needed to stabilize the detector $ad= 1$ $bd=0$ unit=s BIT 0..8 = always 0
H_Shutter_Time	Unsigned Integer 16 bits (PTC 3, PFC 12)	BIT 12..15 = Time needed to stabilize the shutter for closing or opening $ad= 2$ $bd=0$ unit=ms BIT 0..11 = always 0
H_Open_Cover_Step	Unsigned Integer 16 bits (PTC 3, PFC 12)	BIT 8..15 = Number of steps to do in one wave mode cover $ad= 1$ $bd=0$ unit=step BIT 0..7 = always 0
H_Spare	Unsigned Integer 16 bits (PTC 3, PFC 12)	
H_Close_Cover_Step	Unsigned Integer 16 bits (PTC 3, PFC 12)	BIT 8..15 = Number of steps to shut the Cover $ad= 1$ $bd=0$ unit=step BIT 0..7 = always 0
H_Init_Cover_Step	Unsigned Integer 16 bits (PTC 3, PFC 12)	BIT 8..15 = Number of steps to Initialize the Cover $ad= 1$ $bd=0$ unit=step BIT 0..7 = always 0
H_ECA_ACT	Unsigned Integer 16 bits (PTC 3, PFC 12)	BIT 8..15 = ECA actuation time $ad= 1$ $bd=0$ unit=min BIT 0..7 = always 0
H_Annealing_Check_Period	Unsigned Integer 16 bits (PTC 3, PFC 12)	BIT 8..15 = Time between two temperature checks while annealing $a_d= 1$ $b_d=0$ unit=step BIT 0..7 = always 0
H_Annealing_Temp	Unsigned Integer 16 bits (PTC 3, PFC 12)	BIT 7..15 = Requested annealing temperature $a_d= 1$ $b_d=0$ unit=Kelvin BIT 0..6 = always 0
H_Annealing_Time	Unsigned Integer 16 bits (PTC 3, PFC 12)	BIT 8..15 = Duration of annealing $a_d= 1$ $b_d=0$ unit=min BIT 0..7 = always 0
H_Xwin	Unsigned Integer 16 bits (PTC 3, PFC 12)	BIT 13..15 = X coordinate of the first pixel of the calibration window $a_d= 1$ $b_d=0$ unit=pixel BIT 0..12 = always 0
H_Ywin	Unsigned Integer 16 bits (PTC 3, PFC 12)	BIT 12..15 = Y coordinate of the first pixel of the calibration window $a_d= 1$ $b_d=0$ unit=pixel BIT 0..11 = always 0
H_Test_Init	Unsigned Integer 16 bits (PTC 3, PFC 12)	BIT 0..15 = First value of the test pattern $a_d= 1$ $b_d=0$ unit=

## Notes:

 The  $a_d$  and  $b_d$  coefficients are referred to the following transfer function

$$TF: Y = a_d * X_{ADU} + b_d$$

TM- 24: (PID51, PC7, T5, ST1, EID47903) H\_Dump\_Operational\_Parameter

Telecommand Packet Information (VIRTIS)			
Packet name	H_Dump_Operational_Parameter	Instrument	VIRTIS
Packet Function	Dump the Operational Parameter Set		
Generation Rules	Upon reception of HTC_Change_Oper_Param_RAM or HTC_Change_Oper_Param_RAM_EEPROM		
Header Information			
Process ID	51	Packet Category	7
Service Type	5	Service Subtype	1
Structure ID	N.A.	Packet Length	27
Data Field Information			
Data Field	Field Structure	Remarks	
EID	Unsigned Integer 16 bits (PTC 3, PFC 12)	Event Report Id = 47903	
H_Int_Science_Num1	Unsigned Integer 16 bits (PTC 3, PFC 12)	BIT 6..15 = LSB of integration time for science mode BIT 0..5 = always 0  Integration time = Integration time LSW + Integration time MSW * 1024) * 512 10 <sup>-6</sup> unit=sec	
H_Int_Science_Num2	Unsigned Integer 16 bits (PTC 3, PFC 12)	BIT 8..15 = MSB of integration time for science mode BIT 0..7 = always 0	
H_SPARE	Unsigned Integer 16 bits (PTC 3, PFC 12)		
H_Sum	Unsigned Integer 16 bits (PTC 3, PFC 12)	BIT 8..15 = Flag indicating if the spectra have to be summed 0=no summing 1=summing BIT 0..7 = always 0	
H_N_Frame	Unsigned Integer 16 bits (PTC 3, PFC 12)	BIT 5..15 = Repetition rate when no summing $a_d=1$ $b_d=0$ unit=frame BIT 0..4 = always 0	
H_N_Sum_Frame	Unsigned Integer 16 bits (PTC 3, PFC 12)	BIT 8..15 = Number of successive summed frames when H_Sum is set $a_d=1$ $b_d=0$ unit=frame BIT 0..7 = always 0	
H_Dark_Rate	Unsigned Integer 16 bits (PTC 3, PFC 12)	BIT 8..15 = Number of successive frames between 2 dark measurements $a_d=1$ $b_d=0$ unit=frame BIT 0..7 = always 0	
H_Comp	Enumerated parameter 16 bits (PTC 2, PFC 16)	BIT 8..15 = Compression mode 0= No compression 1=Lossless, 2D 2=Wavelet_F1 2bits/datum 3=Wavelet_F2 1.5 bit/datum 4=Wavelet_F3 1 bit/datum summing BIT 0..7 = always 0	
Notes: The $a_d$ and $b_d$ coefficients are referred to the following transfer function TF: $Y = a_d * X_{ADU} + b_d$			

TM- 25: (PID51, PC7, T5, ST1, EID47906) H\_Dump\_Pixel\_Map\_Parameter

Telecommand Packet Information (VIRTIS)			
Packet name	H_Dump_Pixel_Map_Parameter	Instrument	VIRTIS
Packet Function	Dump the Pixel Map Parameter Set		
Generation Rules	Upon reception of HTC_Change_Pixel_Map_Param_RAM or HTC_Change_Pixel_Map_Param_RAM_EEPROM		
Header Information			
Process ID	51	Packet Category	7
Service Type	5	Service Subtype	1
Structure ID	N.A.	Packet Length	107
Data Field Information			
Data Field	Field Structure	Remarks	
EID	Unsigned Integer 16 bits (PTC 3, PFC 12)	Event Report Id = 47906	
H_Pix_Map_C11	Real ((PTC 5, PFC 1)	Each parameter is a real 32bit BIT 9..31=Fraction BIT 1..8=Exponent BIT 0=Sign	
H_Pix_Map_C12	Real ((PTC 5, PFC 1)		
H_Pix_Map_C13	Real ((PTC 5, PFC 1)		
H_Pix_Map_C21	Real ((PTC 5, PFC 1)		
H_Pix_Map_C22	Real ((PTC 5, PFC 1)		
H_Pix_Map_C23	Real ((PTC 5, PFC 1)		
H_Pix_Map_C31	Real ((PTC 5, PFC 1)		
H_Pix_Map_C32	Real ((PTC 5, PFC 1)		
H_Pix_Map_C33	Real ((PTC 5, PFC 1)		
H_Pix_Map_C41	Real ((PTC 5, PFC 1)		
H_Pix_Map_C42	Real ((PTC 5, PFC 1)		
H_Pix_Map_C43	Real ((PTC 5, PFC 1)		
H_Pix_Map_C51	Real ((PTC 5, PFC 1)		
H_Pix_Map_C52	Real ((PTC 5, PFC 1)		
H_Pix_Map_C53	Real ((PTC 5, PFC 1)		
H_Pix_Map_C61	Real ((PTC 5, PFC 1)		
H_Pix_Map_C62	Real ((PTC 5, PFC 1)		
H_Pix_Map_C63	Real ((PTC 5, PFC 1)		
H_Pix_Map_C71	Real ((PTC 5, PFC 1)		
H_Pix_Map_C72	Real ((PTC 5, PFC 1)		
H_Pix_Map_C73	Real ((PTC 5, PFC 1)		
H_Pix_Map_C81	Real ((PTC 5, PFC 1)		
H_Pix_Map_C82	Real ((PTC 5, PFC 1)		
H_Pix_Map_C83	Real ((PTC 5, PFC 1)		
Notes:			

TM- 26: (PID51, PC7, T5, ST1, EID47903) EVENT\_H\_PIX\_MAP\_CHECK\_SUCCESS

Telecommand Packet Information (VIRTIS)			
Packet name	EVENT_H_PIX_MAP_CHECK_SUCCESS	Instrument	VIRTIS
Packet Function	Check of H-Pixel Map was successful		
Generation Rules	Upon upload of the pixel map to PEM-H		
Header Information			
Process ID	51	Packet Category	7
Service Type	5	Service Subtype	1
Structure ID	N.A.	Packet Length	1017
Data Field Information			
Data Field	Field Structure	Remarks	
EID	Unsigned Integer 16 bits (PTC 3, PFC 12)	Event Report Id = 47910	
DEAD_PIX_NUM	Unsigned Integer 16 bits (PTC 3, PFC 12)	total number of dead pixels detected within the spectrum	
DEAD_PIX_X_POS1	Unsigned Integer 16 bits (PTC 3, PFC 12)		
DEAD_PIX_Y_POS1	Unsigned Integer 16 bits (PTC 3, PFC 12)		
DEAD_PIX_SPEC_POS1	Unsigned Integer 16 bits (PTC 3, PFC 12)		
DEAD_PIX_X_POS2			
DEAD_PIX_Y_POS2			
DEAD_PIX_SPEC_POS2			
-----	-----	-----	
DEAD_PIX_X_POS167	Unsigned Integer 16 bits (PTC 3, PFC 12)		
DEAD_PIX_Y_POS167	Unsigned Integer 16 bits (PTC 3, PFC 12)		
DEAD_PIX_SPEC_POS167	Unsigned Integer 16 bits (PTC 3, PFC 12)		
SPARE	Unsigned Integer 16 bits (PTC 3, PFC 12)		
Notes: The $a_d$ and $b_d$ coefficients are referred to the following transfer function TF: $Y = a_d * X_{ADU} + b_d$			

### 3.2.1.4 Test TMs

The user responds to the Connection Test Request TC with a predefined test information report within 10 sec.

TM- 27: (PID51, PC7, T17, ST2): Connection Test Report

<b>Telemetry Packet Information (VIRTIS)</b>			
Packet name	Connection Test Report	Instrument	VIRTIS
Packet Function	To show that instrument is able to communicate.		
Generation Rules	Solicited by Connection Test Request TC (17,1).		
<b>Header Information</b>			
Process ID	51	Packet Category	7
Service Type	17	Service Subtype	2
Structure ID	N.A.	Packet Length	9
<b>Data Field Information</b>			
Data Field	Field Structure	Remarks	
<b>Notes:</b>			
No data field			

### 3.2.1.5 Science Data Transfer TMs - HS link

VIRTIS transfers Science Data to the SSMM via the HS link according to the Science Data Packet Generation TCs. Science Data transmission to RTU via the Serial 16 bit Digital channel is described below.

Scientific data are transmitted in groups according to the mechanism hereafter described (see Fig. 5 and Fig. 6). Each group is composed of data relative to the same (composite) acquisition from one of the three VIRTIS detectors.

Scientific data are generated from the three VIRTIS data channels (i.e. M VIS, M IR and H). They are formatted in separate TM packets of the same Type and Sub-Type whose Process IDs are listed in the following table.

Detector	PID
M-VIS	52
M-IR	52
H-IR	53

TAB. 10: Science TM PIDs

Data for both M detectors are transmitted on a (composite) acquisition unit basis: each composite slice acquired according to the active M-mode is broken down in sub-slices (size spatial\*spectral=64\*144). The number of sub-slices ( $N_{sbs}$ ) depends on the detector size and on the active mode and can vary from a minimum of 1 to a maximum of 12 (in case of detector calibration). Each of the  $N_{sbs}$  sub-slices is compressed (default: lossless i.e. reversible compression) obtaining  $N_{sbs}$  compressed sub-slice whose max size is 9216 word (when compression type = no compression); they can required up to a maximum of 19 packets each to be transmitted.

The order of sub-slices transmission is in spectral direction, both for M and H; the number of sub-slices in spatial direction ( $N_{SSD}$ ) is specified in the science data header.

For H data formatting there are three different image types, each type with its own formatting:

- "image slice": this slice, made of 12 subslices, contains a 432x256 pixel image;
- "spectra slice": this slice, made of 24 subslices, contains 432 pixels x 8 orders x 64 spectra;
- "spectrum": in this case the decomposition into subslices does not applies; a sequence of 3456 words is sent in 7 packets.

The use of these different data formatting is the following:

- in the nominal modes (H\_Science\_Maximum\_Data\_Rate, H\_Science\_Nominal\_Data\_Rate, H\_Science\_Minimum\_Data\_Rate, H\_USer\_Defined, H\_Nominal\_Simulation), "spectra slice" (which give the actual scientific data) are interleaved with "spectrum", which contains dark data;
- in H\_Calibration mode, 7 "image slice" and 2 "spectrum" are sent in a calibration session;
- in H\_Spectral\_Calibration\_Simulation 2 "image slice" are sent in a calibration session.

The image type is identified in the Image Type field of Science Data Header (see below); the dark data (i.e.e. data with shutter closed) are identified by the Shutter State field of Science Data Header.

Note that the science data volume generated by each channel is strongly dependent on the active operative mode, but even for the same mode, the actual data volume changes as a result of data compression: in general, only data volume before compression can be known exactly. The max output data volume can be calculated assuming a compression factor = 2, as a lossless compression with minimum compression factor equal to 2 is applied for default.

Note:

On the 1355 HS link the byte order of the 16 bit word shall be most significant Byte (MSByte) first, least significant byte (LSByte) last while each byte will be trasmitted "little endian" (i.e. least significant bit LSB first, most significant bit MSB last).



DELETED

Fig. 5: H Science Data TMs

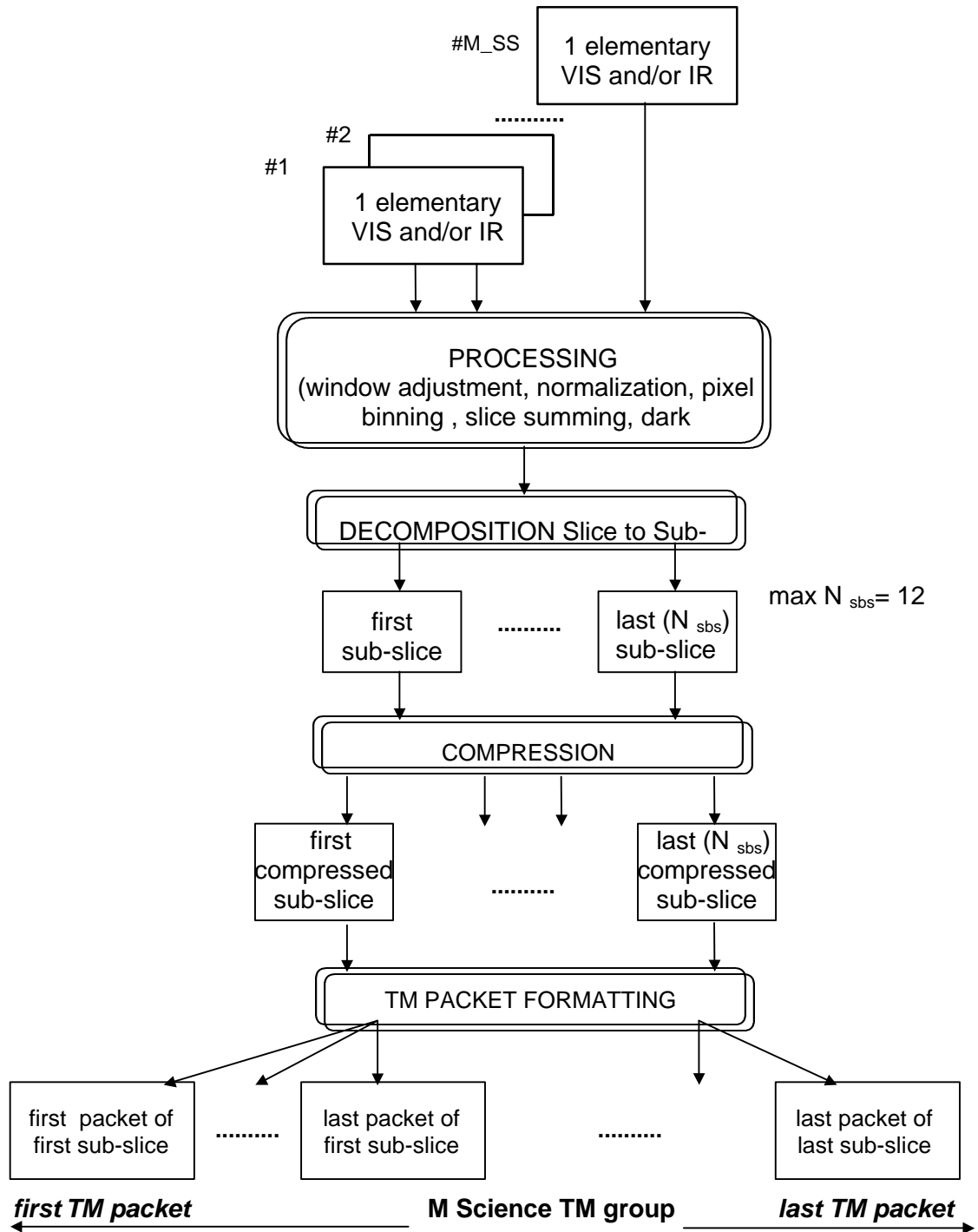

NOTE:  $M_{SS}$  = commanded Slice Summing

Fig. 6: M Science Data TMs

### 3.2.1.6 Science Data Header

The first 4 words of each Source Data field in the Science TM packet form the Science Data Header (SDH) . This is composed of the following information:

ACQUISITION								ID								SCIENCE  DATA  HEADER
A	A	A	A	A	A	A	A	A	A	A	A	A	A	A	A	
SLICE								INFORMATION								
N	N	N	N	N	N	N	N	S	S	S	S	S	S	S	S	
PACKET								INFORMATION								
B	B	B	M	M	M	M	M	P	P	P	P	P	P	P	P	
DATA								TYPE								
Q	T	H	K	K	K	Z	Z	C	C	C	C	C	C	C	C	

#### AAAA AAAA AAAA AAAA

a progressive number that identifies this (composite) acquisition relative to the detector specified by PID; it is reset to zero at power-on or reset, incremented for each group of the same detector and wrapped around its maximum value.

For -M: Serial number of Slices (M-PEM acquisition)

For-H: Serial number of Slices or number of spectrum (H-PEM acquisition)

#### NNNNNNNN

N sbs: the number of sub-slices that compose this slice

For -M: = 1..12

For-H = depends on data type

Image slice=12

Spectra slice=24

Spectrum=0

#### SSSSSSSS

Sub-slice serial number inside the Sub-slice sequence (1...N<sub>sbs</sub>)

For -M: = 1..12

For-H = depends on data type

Image slice=1..12

Spectra slice=1..24

Spectrum=0

#### BBB

N<sub>SSD</sub> : the number of sub-slices in the spatial direction

For -M: = 1 or 4

For-H = depends on data type

Image slice=4

Spectra slice=1

Spectrum=1

#### MMMMM

M<sub>p</sub> : the number of packets needed to transmit this compressed sub-slice

For -M: = 1..19

For-H = depends on data type

Image slice=1..19

Spectra slice=1..19

Spectrum=7

**PPPPPPP**

Packet serial number inside the sub-slice packet sequence (1...M<sub>p</sub>)

For -M: = 1..19

For-H = depends on data type

Image slice=1..19

Spectra slice=1..19

Spectrum=1..7

**Q**

if set to 1 it means that the last word in the SOURCE DATA field is a dummy one, put only to have an even number of words in the packet

0=real science word

1=dummy word

**T**

For -M: = Spectrum type:,0=IR,1=VIS

For-H = Always =0

**H**

Shutter state:

0=Open

1=Closed

**KKK**

Compression mode:

0=No compression

1 = Lossless 2D

2 = Wavelet\_F1 2bit/datum

3 = Wavelet\_F2 1.5 bit/ datum

4 = Wavelet\_F3 1 bit/datum

**ZZ**

For -M: = Not used (always 00)

For-H = average/summing mode

0=No average / No summing

1=Average / No summing

2=No average / Summing

3=Average / Summing

**CCCCCCC**

For -M: = Image type:

0=Science

1=Calibration phase 0

2=Calibration phase 1

3=Calibration phase 2

4=Calibration phase 3

5=Calibration phase 4

6=Calibration phase 5

7=Calibration phase 6

255= ME/ M-IFE Test

For-H = Image type

0 = Image slice (12 subslices which composes a 432x256 slice);

1 = Spectra slice (24 subslices which composes a 432 pixels x 64 spectra x 8 orders structure);

2 = Spectrum (3456 words transmitted by 7 packets),

255= ME/H-IFE Test

TM- 28: (PID52, PC12, T20, ST13): M Science Data (HS Link)

Telemetry Packet Information (VIRTIS)			
Packet name	Science Data (HS Link)	Instrument	VIRTIS
Packet Function	Reports Science Data on HS Link		
Generation Rules	Generated in Science mode		
Header Information			
Additional Header	1C 00 00 00		
Process ID	52	Packet Category	12
Service Type	20	Service Subtype	13
Structure ID	N.A.	Packet Length	variable (19+1013)
Data Field Information			
Data Field	Field Structure	Remarks	
Acquisition ID	Unsigned Integer 16 bits (PTC 3, PFC 12)	See <b>Science Data Header</b> pag.131	
Slice Information	Unsigned Integer 16 bits (PTC 3, PFC 12)	See <b>Science Data Header</b> pag.131	
Packet Information	Unsigned Integer 16 bits (PTC 3, PFC 12)	See <b>Science Data Header</b> pag.131	
Data Type	Unsigned Integer 16 bits (PTC 3, PFC 12)	See <b>Science Data Header</b> pag.131	
Data Word	Unsigned Integer 16 bits (PTC 3, PFC 12)	Repeated n times	
Notes:			

TM- 29: (PID53, PC12, T20, ST13): H Science Data (HS Link)

Telemetry Packet Information (VIRTIS)			
Packet name	Science Data (HS Link)	Instrument	VIRTIS
Packet Function	Reports Science Data on HS Link		
Generation Rules	Generated in Science mode		
Header Information			
Additional Header	1C 00 00 00		
Process ID	53	Packet Category	12
Service Type	20	Service Subtype	13
Structure ID	N.A.	Packet Length	variable (19+1013)
Data Field Information			
Data Field	Field Structure	Remarks	
Acquisition ID	Unsigned Integer 16 bits (PTC 3, PFC 12)	See <b>Science Data Header</b> pag.131	
Slice Information	Unsigned Integer 16 bits (PTC 3, PFC 12)	See <b>Science Data Header</b> pag.131	
Packet Information	Unsigned Integer 16 bits (PTC 3, PFC 12)	See <b>Science Data Header</b> pag.131	
Data Type	Unsigned Integer 16 bits (PTC 3, PFC 12)	See <b>Science Data Header</b> pag.131	
Data Word	Unsigned Integer 16 bits (PTC 3, PFC 12)	Repeated n times	
Notes:			

### 3.2.1.7 Science Data Transfer TMs - RTU link

When the HS link is not available, a Degraded Science Mode can be commanded in order to transfer Science data on the RTU link. As a smaller data rate can be sustained on this link, less data are prepared and transmitted to the DMS.

Science data are sent on RTU link with the same format used for the HS link: the packet structure is the same.

TM- 30: (PID52, PC12, T20, ST3): M Science Data (RTU Link)

<b>Telemetry Packet Information (VIRTIS)</b>			
Packet name	Science Data (RTU Link)	Instrument	VIRTIS
Packet Function	Reports Science Data on HS Link		
Generation Rules	Generated in Science mode		
<b>Header Information</b>			
Additional Header	NOT present		
Process ID	52	Packet Category	12
Service Type	20	Service Subtype	3
Structure ID	N.A.	Packet Length	variable (19+1017)
<b>Data Field Information</b>			
Data Field	Field Structure	Remarks	
Acquisition ID	Unsigned Integer 16 bits (PTC 3, PFC 12)	See <b>Science Data Header</b> pag.131	
Slice Information	Unsigned Integer 16 bits (PTC 3, PFC 12)	See <b>Science Data Header</b> pag.131	
Packet Information	Unsigned Integer 16 bits (PTC 3, PFC 12)	See <b>Science Data Header</b> pag.131	
Data Type	Unsigned Integer 16 bits (PTC 3, PFC 12)	See <b>Science Data Header</b> pag.131	
Data Word	Unsigned Integer 16 bits (PTC 3, PFC 12)	Repeated n times	
<b>Notes:</b>			



TM- 31: (PID53, PC12, T20, ST3): H Science Data (RTU Link)

<b>Telemetry Packet Information (VIRTIS)</b>			
Packet name	Science Data (RTU Link)	Instrument	VIRTIS
Packet Function	Reports Science Data on HS Link		
Generation Rules	Generated in Science mode		
<b>Header Information</b>			
Additional Header	NOT present		
Process ID	53	Packet Category	12
Service Type	20	Service Subtype	3
Structure ID	N.A.	Packet Length	variable (19+1017)
<b>Data Field Information</b>			
Data Field	Field Structure	Remarks	
Acquisition ID	Unsigned Integer 16 bits (PTC 3, PFC 12)	See <b>Science Data Header</b> pag.131	
Slice Information	Unsigned Integer 16 bits (PTC 3, PFC 12)	See <b>Science Data Header</b> pag.131	
Packet Information	Unsigned Integer 16 bits (PTC 3, PFC 12)	See <b>Science Data Header</b> pag.131	
Data Type	Unsigned Integer 16 bits (PTC 3, PFC 12)	See <b>Science Data Header</b> pag.131	
Data Word	Unsigned Integer 16 bits (PTC 3, PFC 12)	Repeated n times	
<b>Notes:</b>			

### 3.2.1.8 Memory Management TMs

According to the received Memory Management TCs, TM reports are generated containing the Memory Dump or the Memory Check ( see Appendix A) of the commanded memory area.

Dump can be performed anywhere inside physical memory but PROM content can not be dumped directly but only through its copy on the Program Memory.

The services relies on the "memory ID" concept, defined in **TAB. 11**.

**NOTE:** No scattered requests are foreseen for VIRTIS, **therefore the number of blocks for memory dump/check is always 1.**

Moreover, **only requests for dump of blocks whose length fits one TM packet will be accepted;** therefore each block dump requires only one TM report.

TM- 32: (PID51, PC9, T6, ST6): Memory Dump Report

Telemetry Packet Information (VIRTIS)			
Packet name	Memory Dump Report	Instrument	VIRTIS
Packet Function	Reports dump of a memory block		
Generation Rules	Solicited by Dump Memory TC (6,5).		
Header Information			
Process ID	51	Packet Category	9
Service Type	6	Service Subtype	6
Structure ID	N.A.	Packet Length	variable (17+4105)
Data Field Information			
Data Field	Field Structure	Remarks	
Memory ID & Number of blocks	Unsigned Integer 16 bits (PTC 2, PFC 16)	BIT 15: Number of blocks Always 1 BIT 8..14: always 0 BIT 0...7: Memory ID 140 – EEPROM / 8bit items 141 – PM / 48bit items 142 – DM / 40bit items 143 – DM / 16bit items 144 – PM Port / 48bit items 145 – DM Port / 40bit items	
Start Address	Unsigned Integer 32 bits (PTC 3, PFC 14)	BIT 0..31: Dump start address	
Block Length	Unsigned Integer 16 bits (PTC 3, PFC 12)	BIT 0.15: Number of items in the block	
Data Word	Unsigned Integer 16 bits (PTC 3, PFC 12)	BIT 0..15: Word dump, repeated n times, where n= If ID 140=1..4088 max If ID 141=1..681 max If ID 142=1..681 max If ID 143=1..2044 max If ID 144=1..681 max If ID 145=1..681 max	
<b>Notes:</b>			

TM- 33: (PID51, PC7, T6, ST10): Memory Check Report

Telemetry Packet Information (VIRTIS)			
Packet name	Memory Check Report	Instrument	VIRTIS
Packet Function	Reports checksum of a memory block		
Generation Rules	Solicited by Check Memory TC (6,9).		
Header Information			
Process ID	51	Packet Category	7
Service Type	6	Service Subtype	10
Structure ID	N.A.	Packet Length	21
Data Field Information			
Data Field	Field Structure	Remarks	
Memory ID & Number of blocks	Unsigned Integer 16 bits (PTC 2, PFC 16)	BIT 15: Number of blocks Always 1 BIT 8..14: always 0 BIT 0...7: Memory ID 140 – EEPROM / 8bit items 141 – PM / 48bit items 142 – DM / 40bit items 143 – DM / 16bit items 144 – PM Port / 48bit items 145 – DM Port / 40bit items	
Start Address	Unsigned Integer 32 bits (PTC 3, PFC 14)	BIT 0..31: Check start address	
Block Length	Unsigned Integer 16 bits (PTC 3, PFC 12)	Number of items in the block (items size defined by Memory ID as per <b>TAB. 11</b> )	
SPARE	Unsigned Integer 16 bits (PTC 3, PFC 12)		
Checksum	Unsigned Integer 16 bits (PTC 3, PFC 12)	Checked block lenght	
Notes:			

### 3.2.2 Telecommand Packet Definitions

Detailed description of TC packets is given in this section. The information is formatted in compliance with RD8, part 4, section 2.8.3.2.1. The data types used for parameters are defined in RD8, part 4, section 3. The service grouping is the same defined in section 2.8.3.1 of the current document.

**NOTE:** telecommands shall consist of an even number of octets. If the number of octets is odd, one padding octet is added at the end (unless a pad field is explicitly indicated). The Packet Length field doesn't take into account the padding octets.

#### 3.2.2.1 Service 1 - Housekeeping Reporting

This service enables or disables telemetry generation, separately for each SID.

TC- 1: (PID51, PC12, T3, ST5) Enable\_HK\_Report\_Generation

Telecommand Packet Information (VIRTIS)			
Packet name	Enable_HK_Report_Generation	Instrument	VIRTIS
Packet Function	Enable generation of H/K corresponding to the SID parameter		
Verification Rules	H/K TM is generated, as soon as VIRTIS reaches the mode in which it is available.		
Header Information			
Process ID	51	Packet Category	12
Service Type	3	Service Subtype	5
Structure ID	N.A.	Packet Length	7
Data Field Information			
Data Field	Field Structure	Remarks	
SID	Unsigned Integer 16 bits (PTC 3, PFC 12)	BIT 8..15: SID of the H/K TM to be enabled Valid range:1..7 ,128 1= ME Default HK 2= ME/M General HK 3= ME/H General HK 4= M-VIS HK 5= M-IR HK 6= H-HK 7= ALL 128=if 1 sample of analog HK <b>isn't</b> done (it is used only for SW internal tests) BIT 0..7: don't care	
<b>Notes:</b>			
Acceptance Success/Failure Report can be required.			
Execution Success/Failure Report shall never be required.			
Actual TM generation starts only if VIRTIS is in the mode in which the relevant data are available.			
SID=7 (All) is possible only if VIRTIS is not in Safe mode, in Safe mode only SID=1 is accepted			

TC- 2: (PID51, PC12, T3, ST6) Disable\_HK\_Report\_Generation

Telecommand Packet Information (VIRTIS)			
Packet name	Disable_HK_Report_Generation	Instrument	VIRTIS
Packet Function	Disable generation of H/K corresponding to the SID parameter		
Verification Rules	H/K TM is no more sent.		
Header Information			
Process ID	51	Packet Category	12
Service Type	3	Service Subtype	6
Structure ID	N.A.	Packet Length	7
Data Field Information			
Data Field	Field Structure	Remarks	
SID	Unsigned Integer 16 bits (PTC 3, PFC 12)	BIT 8..15: SID of the H/K TM to be enabled Valid range:1..6 1= ME Default HK 2= ME/M General HK 3= ME/H General HK 4= M-VIS HK 5= M-IR HK 6= H-HK BIT 0..7: don't care	
<b>Notes:</b>			
Acceptance Success/Failure Report can be required.			
Execution Success/Failure Report shall never be required.			

### 3.2.2.2 Service 6 - Memory Management

This service requires to load, dump and check (see Appendix A) areas of memory. It relies on the "Memory\_Id" concept, i.e. an unique identifier of the type of addressed memory. The identifiers allocated to payloads are shown in RD 1 while the following table documents the Memory\_Ids usage required for the VIRTIS instrument.

Memory_Id	Memory type	Memory width	PTC,PTF	Checksum type	Remarks
140	EEPROM	8 bits	3, 4	CRC	
141	Program Memory (PM)	48 bits	3,12	CRC	Parameter split on three 16-bit words
142	Data Memory (DM)	40 bits	3,12	CRC	Parameter split on three 16-bit words with an empty octet at the end
143	Data Memory (DM)	16 bits	3,12	CRC	
144	PM port	48 bits	3,12	CRC	Parameter split on three 16-bit words
145	DM port	40 bits	3,12	CRC	Parameter split on three 16-bit words with an empty octet at the end

TAB. 11: Memory\_Ids usage

Notes on the VIRTIS instrument implementation of the service:

1. No scattered requests are foreseen, therefore the number of blocks for the memory dump/load/check is **always = 1**
2. Only requests for dump of blocks whose length fits in **only one TM packet** will be accepted.

TC- 3: (PID51, PC12, T6, ST2) Load\_Memory

Telecommand Packet Information (VIRTIS)			
Packet name	Load_Memory	Instrument	VIRTIS
Packet Function	Load a block of memory.		
Verification Rules	Memory Dump Report TM		
Header Information			
Process ID	51	Packet Category	12
Service Type	6	Service Subtype	2
Structure ID	N.A.	Packet Length	variable (15..241)
Data Field Information			
Data Field	Field Structure	Remarks	
Memory ID & Number of blocks	Unsigned Integer 16 bits (PTC 2, PFC 16)	BIT 15: Number of blocks Always 1 BIT 8..14: always 0 BIT 0...7: Memory ID Valid range=140..143 140 – EEPROM / 8bit items 141 – PM / 48bit items 142 – DM / 40bit items 143 – DM / 16bit items 144 – PM Port / 48bit items (reserved see note) 145 – DM Port / 40bit items(reserved see note)	
Start Address	Unsigned Integer 32 bits (PTC 3, PFC 14)	BIT 0..31: Load start address Valid range: MID140=20000000..200FFFFFF MID141=006300..01FFFF MD142=00000000..0007FFFF MID143=30000000..301FFFFFF MID144=reserved MID145=reserved	
Block Length	Unsigned Integer 16 bits (PTC 3, PFC 12)	BIT 0..15: Number of items of block (item size defined by Memory ID as per <b>TAB. 11</b> ) Valid range= 1..228	
Data word	Unsigned Integer 16 bits (PTC 3, PFC 12)	BIT 0..15: Word to be loaded, repeated n times, where n= 1..114	
Notes:			
Acceptance Success/Failure Report can be required.			
Execution Success/Failure Report shall never be required.			
MemID 144 and MemID 145 upload/check and dump of Port memory should only be done by the S/W developer because the Ports are real hardware interfaces which loading is critical. Additionally the Port content is undefined from the user point of view because internally the PROM software uses the Ports, therefore dump of ports makes only sense to do by S/W developer too			
In case of MemID 140 block length is a multiple of two			



TC- 4: (PID51, PC12, T6, ST5) Dump\_Memory

Telecommand Packet Information (VIRTIS)			
Packet name	Dump_Memory	Instrument	VIRTIS
Packet Function	Commands to dump a memory block		
Verification Rules	Memory Dump Report TM		
Header Information			
Process ID	51	Packet Category	12
Service Type	6	Service Subtype	5
Structure ID	N.A.	Packet Length	13
Data Field Information			
Data Field	Field Structure	Remarks	
Memory ID & Number of blocks	Unsigned Integer 16 bits (PTC 2, PFC 16)	BIT 15: Number of blocks Always 1 BIT 8..14: always 0 BIT 0...7: Memory ID Valid range=140..143 140 – EEPROM / 8bit items 141 – PM / 48bit items 142 – DM / 40bit items 143 – DM / 16bit items 144 – PM Port / 48bit items (reserved see note) 145 – DM Port / 40bit items(reserved see note)	
Start Address	Unsigned Integer 32 bits (PTC 3, PFC 14)	BIT 0..31: Dump start address Valid range: MID140=20000000..200FFFFFF MID141=000000..01FFFF MD142=00000000..0007FFFF MID143=30000000..301FFFFFF MID144=reserved MID145=reserved	
Block Length	Unsigned Integer 16 bits (PTC 3, PFC 12)	BIT 0..15: Number of items of block (item size defined by Memory ID as per <b>TAB. 11</b> ). The block length shall allow the Memory Dump TM to fit into one packet. Valid range: MID140=1...4088 MID141=1..681 MD142=1...681 MID143=1...2044 MID144=reserved MID145=reserved	
<b>Notes:</b>			
Acceptance Success/Failure Report can be required.			
Execution Success/Failure Report shall never be required.			
MemID 144 and MemID 145 upload/check and dump of Port memory should only be done by the S/W developer because the Ports are real hardware interfaces which loading is critical. Additionally the Port content is undefined from the user point of view because internally the PROM software uses the Ports, therefore dump of ports makes only sense to do by S/W developer too			
In case of MemID 140 block length is a multiple of two			

TC- 5: (PID51, PC12, T6, ST9) Check\_Memory

Telecommand Packet Information (VIRTIS)			
Packet name	Check_Memory	Instrument	VIRTIS
Packet Function	Commands to perform checksum computation of a memory block.		
Verification Rules	Memory Check Report TM		
Header Information			
Process ID	51	Packet Category	12
Service Type	6	Service Subtype	9
Structure ID	N.A.	Packet Length	13
Data Field Information			
Data Field	Field Structure	Remarks	
Memory ID & Number of blocks	Unsigned Integer 16 bits (PTC 2, PFC 16)	BIT 15: Number of blocks Always 1 BIT 8..14: always 0 BIT 0...7: Memory ID Valid range=140..143 140 – EEPROM / 8bit items 141 – PM / 48bit items 142 – DM / 40bit items 143 – DM / 16bit items 144 – PM Port / 48bit items (reserved see note) 145 – DM Port / 40bit items(reserved see note)	
Start Address	Unsigned Integer 32 bits (PTC 3, PFC 14)	BIT 0..31: Dump start address Valid range: MID140=20000000..200FFFFFF MID141=006300..01FFFF MD142=00000000..0007FFFF MID143=30000000..301FFFFFF MID144=reserved MID145=reserved	
Block Length	Unsigned Integer 16 bits (PTC 3, PFC 12)	BIT 0..15: Number of items of block to be checked (item size defined by Memory ID as per <b>TAB. 11</b> ). Valid range: 1...65535	
Notes:			
Acceptance Success/Failure Report can be required. Execution Success/Failure Report shall never be required. MemID 144 and MemID 145 upload/check and dump of Port memory should only be done by the S/W developer because the Ports are real hardware interfaces which loading is critical. Additionally the Port content is undefined from the user point of view because internally the PROM software uses the Ports, therefore dump of ports makes only sense to do by S/W developer too In case of MemID 140 block length is a multiple of two			

### 3.2.2.3 Service 9 - Time Management

This service provides the time synchronization signal.

TC- 6: (PID51, PC12, T9, ST1) Accept\_Time\_Update

Telecommand Packet Information (VIRTIS)			
Packet name	Accept_Time_Update	Instrument	VIRTIS
Packet Function	Supplies the instrument with the Spacecraft Elapsed Time to allow synchronisation.		
Verification Rules	Time in Data Field Header of following TM is synchronised		
Header Information			
Process ID	51	Packet Category	12
Service Type	9	Service Subtype	1
Structure ID	N.A.	Packet Length	11
Data Field Information			
Data Field	Field Structure	Remarks	
SCET_I	Unsigned Integer 32 bits (PTC 3, PFC 14)	BIT 1..31: First 32 of 48 bits CUC Time, i.e. whole seconds BIT 0: always	
SCET_F	Unsigned Integer 16 bits (PTC 3, PFC 12)	BIT 0..15: Last 16 of 48 bits CUC Time, i.e. fractional seconds	
<b>Notes:</b>			
Acceptance Success/Failure Report can be required.			
Execution Success/Failure Report shall never be required.			

### 3.2.2.4 Service 17 – Connection Test

This service requests the Connection Test Report.

TC- 7: (PID51, PC12, T17, ST1) Connection\_Test\_Request

Telecommand Packet Information (VIRTIS)			
Packet name	Connection_Test_Request	Instrument	VIRTIS
Packet Function	Tests communication, asking the instrument to reply with Connection Test report.		
Verification Rules	Connection Test Report TM		
Header Information			
Process ID	51	Packet Category	12
Service Type	17	Service Subtype	1
Structure ID	N.A.	Packet Length	5
Data Field Information			
Data Field	Field Structure	Remarks	
<b>Notes:</b>			
No data field			
Acceptance Success/Failure Report can be required.			
Execution Success/Failure Report shall never be required.			

### 3.2.2.5 Service 20 – Science Reporting

This service drives one of the VIRTIS units V-H or V-M in or out the Data Production state. The Operative Mode which is entered as consequence of the Enable\_Science telecommand depends on the current settings of the Operative Parameters of both PEMS.

TC- 8: (PID51, PC12, T20, ST1) Enable\_Science\_RTU\_Link

Telecommand Packet Information (VIRTIS)			
Packet name	Enable_Science_RTU_Link	Instrument	VIRTIS
Packet Function	Start the Science data production for the indicated unit		
Verification Rules	Science Data TM		
Header Information			
Process ID	51	Packet Category	12
Service Type	20	Service Subtype	1
Structure ID	N.A.	Packet Length	7
Data Field Information			
Data Field	Field Structure	Remarks	
PID	Unsigned Integer 16 bits (PTC 2, PFC 16)	BIT 9..15: Process ID of the TM source to which this command applies : Valid range= 52..53 52=V-M 53=V-H BIT0..8: always 0	
<b>Notes:</b>			
Acceptance Success/Failure Report can be required.			
Execution Success/Failure Report shall never be required.			

TC- 9: (PID51, PC12, T20, ST2) Disable\_Science\_RTU\_Link

Telecommand Packet Information (VIRTIS)			
Packet name	Disable_Science_RTU_Link	Instrument	VIRTIS
Packet Function	Stop the Science data production for the indicated unit		
Verification Rules	Science Data TM		
Header Information			
Process ID	51	Packet Category	12
Service Type	20	Service Subtype	2
Structure ID	N.A.	Packet Length	7
Data Field Information			
Data Field	Field Structure	Remarks	
PID	Unsigned Integer 16 bits (PTC 2, PFC 16)	BIT 9..15: Process ID of the TM source to which this command applies : Valid range= 52..53 52=V-M 53=V-H BIT0..8: always 0	
<b>Notes:</b> Acceptance Success/Failure Report can be required. Execution Success/Failure Report should be required, because some time is needed by ME SW to execute the command, in order to make empty the buffers.			

TC- 10: (PID51, PC12, T20, ST10) Enable\_Science\_HS\_Link

Telecommand Packet Information (VIRTIS)			
Packet name	Enable_Science_HS_Link	Instrument	VIRTIS
Packet Function	Start the Science data production for the indicated unit		
Verification Rules	Science Data TM		
Header Information			
Process ID	51	Packet Category	12
Service Type	20	Service Subtype	10
Structure ID	N.A.	Packet Length	7
Data Field Information			
Data Field	Field Structure	Remarks	
PID	Unsigned Integer 16 bits (PTC 2, PFC 16)	BIT 9..15: Process ID of the TM source to which this command applies : Valid range= 52..53 52=V-M 53=V-H BIT0..8: always 0	
<b>Notes:</b> Acceptance Success/Failure Report can be required. Execution Success/Failure Report shall never be required.			

TC- 11: (PID51, PC12, T20, ST11) Disable\_Science\_HS\_Link

Telecommand Packet Information (VIRTIS)			
Packet name	Disable_Science_HS_Link	Instrument	VIRTIS
Packet Function	Stop the Science data production for the indicated unit		
Verification Rules	Science Data TM		
Header Information			
Process ID	51	Packet Category	12
Service Type	20	Service Subtype	11
Structure ID	N.A.	Packet Length	7
Data Field Information			
Data Field	Field Structure	Remarks	
PID	Unsigned Integer 16 bits (PTC 2, PFC 16)	BIT 9..15: Process ID of the TM source to which this command applies : Valid range= 52..53 52=V-M 53=V-H BIT0..8: always 0	
<b>Notes:</b>			
Acceptance Success/Failure Report can be required.			
Execution Success/Failure Report should be required, because some time is needed by ME SW to execute the command, in order to make empty the buffers.			

### 3.2.2.6 Service 192 – VIRTIS Common Private TCs

This service provides commands applicable to the whole VIRTIS instrument without distinction between sub-units.

TC- 12: (PID51, PC12, T192, ST1) VTC\_Enter\_Safe\_Mode

Telecommand Packet Information (VIRTIS)			
Packet name	VTC_Enter_Safe_Mode	Instrument	VIRTIS
Packet Function	Go into Safe mode, i.e. switch off Proximity Electronics Modules, reset Main Electronics and perform primary boot giving control to PROM SW		
Verification Rules	Change of state in Default H/K TM		
Header Information			
Process ID	51	Packet Category	12
Service Type	192	Service Subtype	1
Structure ID	N.A.	Packet Length	5
Data Field Information			
Data Field	Field Structure	Remarks	
<b>Notes:</b>			
No data field			
Acceptance Success/Failure Report can be required.			
Execution Success/Failure Report shall never be required.			

TC- 13: (PID51, PC12, T192, ST2) VTC\_Enter\_Idle\_Mode

Telecommand Packet Information (VIRTIS)			
Packet name	VTC_Enter_Idle_Mode	Instrument	VIRTIS
Packet Function	Go into Idle mode, i.e. executes secondary boot copying code from EEPROM to PM and starting it.		
Verification Rules	Change of state in Default H/K TM		
Header Information			
Process ID	51	Packet Category	12
Service Type	192	Service Subtype	2
Structure ID	N.A.	Packet Length	9
Data Field Information			
Data Field	Field Structure	Remarks	
Start Address	Unsigned Integer 32 bits (PTC 3, PFC 14)	BIT 0..31: Start address in EEPROM of the secondary boot code (start EEPROM address: 0x20000000; end EEPROM address: 0x200FFFFF).. If higher than last EEPROM address, no boot is done and PM code is directly activated (PM address 0x000008).	
<b>Notes:</b>			
Using start address higher than last EEPROM address forces to not perform boot from EEPROM, which allows to upload the software from S/C to PM and execute it in case of EEPROM failure.			
Acceptance Success/Failure Report can be required.			
Execution Success/Failure Report shall never be required.			

TC- 14: (PID51, PC12, T192, ST3) VTC\_Enter\_Test\_Mode

Telecommand Packet Information (VIRTIS)			
Packet name	VTC_Enter_Test_Mode	Instrument	VIRTIS
Packet Function	Go into Test mode of ME or V-H or V-M		
Verification Rules	Change of state in Default H/K TM		
Header Information			
Process ID	51	Packet Category	12
Service Type	192	Service Subtype	3
Structure ID	N.A.	Packet Length	27
Data Field Information			
Data Field	Field Structure	Remarks	
Unit ID	Enumerated Parameter 16 bits (PTC 2, PFC 16)	BIT 14..15: Unit Id Valid range=1 1=ME Test 2=PEM Test (not available in SW 3.6) BIT 0..13: always 0	
M_IFE_TPR	Unsigned Integer 16 bits (PTC 13, PFC 12)	BIT 0..15: M-IFE Test Pattern Repetition Rate [ms] Meaningful only if Unit ID = ME	
M_IFE_VPS_MSB	Unsigned Integer 16 bits (PTC 13, PFC 12)	BIT 15: M-IFE-VIS Pattern Size MSB [words] Meaningful only if Unit ID = ME BIT 0..14: always 0	
M_IFE_VPS_LSB	Unsigned Integer 16 bits (PTC 13, PFC 12)	BIT 0..15: M-IFE-VIS Pattern Size LSB [words] Meaningful only if Unit ID = ME	
M_IFE_IPS_MSB	Unsigned Integer 16 bits (PTC 13, PFC 12)	BIT 15: M-IFE-IR Pattern Size MSB [words] Meaningful only if Unit ID = ME BIT 0..14: always 0	
M_IFE_IPS_LSB	Unsigned Integer 16 bits (PTC 13, PFC 12)	BIT 0..15: M-IFE-IR Pattern Size LSB [words] Meaningful only if Unit ID = ME	
M_SPARE	Unsigned Integer 16 bits (PTC 13, PFC 12)		
H_IFE_TPR	Unsigned Integer 16 bits (PTC 13, PFC 12)	BIT 0..15: H-IFE Test Pattern Repetition Rate [ms] Meaningful only if Unit ID = ME	
H_IFE_PS_MSB	Unsigned Integer 16 bits (PTC 13, PFC 12)	BIT 15: H-IFE-VIS Pattern Size MSB [words] Meaningful only if Unit ID = ME BIT 0..14: always 0	
H_IFE_PS_LSB	Unsigned Integer 16 bits (PTC 13, PFC 12)	BIT 0..15: H-IFE-VIS Pattern Size LSB [words] Meaningful only if Unit ID = ME	
H_SPARE	Unsigned Integer 16 bits (PTC 13, PFC 12)		
Notes:			
Acceptance Success/Failure Report can be required.			
Execution Success/Failure Report shall never be required.			



TC- 15: (PID51, PC12, T192, ST4) VTC\_PEMS

The following commands can be issued :

- PEMs Switch On
- PEMs Switch Off
- PEMs Reset

Telecommand Packet Information (VIRTIS)			
Packet name	VTC_PEMS	Instrument	VIRTIS
Packet Function	Switch both PEMs On, Off or Reset		
Verification Rules	Change of state in Default H/K TM		
Header Information			
Process ID	51	Packet Category	12
Service Type	192	Service Subtype	4
Structure ID	N.A.	Packet Length	7
Data Field Information			
Data Field	Field Structure	Remarks	
Switch ID	Enumerated Parameter 16 bits (PTC 2, PFC 16)	BIT 14..15: command Valid range: 1..3 1=Off 2=On 3=Reset BIT 0..13: always 0	
<b>Notes:</b>			
Acceptance Success/Failure Report can be required.			
Execution Success/Failure Report should be required. Execution time is several seconds in case of XTC_PEM(on), depending on duration of the X-Cover initialization procedure			

TC- 16: (PID51, PC12, T192, ST5) VTC\_Coolers

The following commands can be issued :

- Coolers On / Open Loop + Motor Speed
- Coolers On / Close Loop + Temperature
- Coolers Off

Telecommand Packet Information (VIRTIS)			
Packet name	VTC_Coolers	Instrument	VIRTIS
Packet Function	Command both Coolers for common sessions		
Verification Rules	Change of state in Default H/K TM		
Header Information			
Process ID	51	Packet Category	12
Service Type	192	Service Subtype	5
Structure ID	N.A.	Packet Length	9
Data Field Information			
Data Field	Field Structure	Remarks	
Coolers Status	Enumerated Parameter 16 bits (PTC 2, PFC 16)	BIT 13..15: command Valid range: 1..4 1=Off 2=On Open Loop 3=On Close Loop 4= Stand-by (+28V on, motor drive off) BIT 0..12: always 0	
Temp/Speed	Unsigned Integer 16 bits (PTC 3, PFC 12)	BIT 4...15: Depending on Coolers Status: If 1=N.A. If 2=Cooler motor speed Valid range 1..3800 [rpm], 1...3800[bit] $a_R=1 \quad b_R=0$ If 3=(Temperature [K] – 60) * 102.375 with Temperature range 60...100 Valid range 60...100[Kelvin], 0..4095[bit] $a_R=102.375 \quad b_R=-6142$ If 4= NA BIT 0..12: always 0	
<b>Notes:</b>			
The $a_R$ and $b_R$ coefficients are referred to the following transfer function			
TF: $Y_{bit} = a_R * X + b_R$			
Acceptance Success/Failure Report can be required.			
Execution Success/Failure Report shall never be required.			

TC- 17: (PID51, PC12, T192, ST10) VTC\_Override

Telecommand Packet Information (VIRTIS)			
Packet name	VTC_Override	Instrument	VIRTIS
Packet Function	Override event recovery for the specified category		
Verification Rules	Relevant recovery actions are not performed		
Header Information			
Process ID	51	Packet Category	12
Service Type	192	Service Subtype	10
Structure ID	N.A.	Packet Length	7
Data Field Information			
Data Field	Field Structure	Remarks	
Verification Category	Enumerated Parameter 16 bits (PTC 2, PFC 16)	BIT 13..15: Category to which override applies Valid range: 1...7 1=Category II 2=Category III 3=Category IV-H 4=Category IV-H 5=Category V 6=Category VI 7=All BIT 0..12: always 0	
<b>Notes:</b>			
Acceptance Success/Failure Report can be required.			
Execution Success/Failure Report shall never be required.			
VTC_Confirm has to be sent immediately after without any other TC commanded between VTC_Failure_Override and VTC_Confirm			

TC- 18: (PID51, PC12, T192, ST11) VTC\_Deoverride

Telecommand Packet Information (VIRTIS)			
Packet name	VTC_Deoverride	Instrument	VIRTIS
Packet Function	Remove override to event recovery for the specified category		
Verification Rules	Relevant recovery actions are performed		
Header Information			
Process ID	51	Packet Category	12
Service Type	192	Service Subtype	11
Structure ID	N.A.	Packet Length	7
Data Field Information			
Data Field	Field Structure	Remarks	
Verification Category	Enumerated Parameter 16 bits (PTC 2, PFC 16)	BIT 13..15: Category to which override applies Valid range: 1...7 1=Category II 2=Category III 3=Category IV-H 4=Category IV-H 5=Category V 6=Category VI 7=All BIT 0..12: always 0	
<b>Notes:</b>			
Acceptance Success/Failure Report can be required.			
Execution Success/Failure Report shall never be required.			

TC- 19: (PID51, PC12, T192, ST12) VTC\_Confirm

Telecommand Packet Information (VIRTIS)			
Packet name	VTC_Confirm	Instrument	VIRTIS
Packet Function	Confirm critical commands		
Verification Rules	In case of erroneous operation of confirmation, the events 47630 and 47680 shall be issued		
Header Information			
Process ID	51	Packet Category	12
Service Type	192	Service Subtype	12
Structure ID	N.A.	Packet Length	9
Data Field Information			
Data Field	Field Structure	Remarks	
Packet Service Info	Unsigned Integer 16 bits (PTC 3, PFC 12)	BIT 8..15: Packet subtype of confirmed TC Valid range=4 or 10 4=MTC_ECA or HTC_ECA 10=VTC_failure_override BIT 0..7: Packet type of confirmed TC Valid range=192..194 192= VTC_failure_override 193= MTC_ECA 194= HTC_ECA	
<b>Notes:</b>			
Acceptance Success/Failure Report can be required.			
Execution Success/Failure Report shall never be required.			
To be sent only after a command requiring confirmation of XTC_ECA and VTC_Override commands			

TC- 20: (PID51, PC12, T192, ST13) VTC\_Get\_EEPROM\_Status

Telecommand Packet Definition (VIRTIS)			
Packet name	VTC_Get_EEPROM_Status	Instrument	VIRTIS
Packet Function	Requests all parameters about executable in EEPROM		
Verification Rules	Nominal Progress Event "EEPROM_Stat_Report"		
Header Information			
Process ID	51	Packet Category	12
Service Type	192	Service Subtype	13
Structure ID	N/A	Packet Length	5
Data Field Information			
Data Field	Field Structure	Remarks	
<b>Notes:</b>			
No data field			
Acceptance Success/Failure Report can be required.			
Execution Success/Failure Report shall never be required.			

### 3.2.2.7 Service 193 – VIRTIS-M Common Private TCs

This service provides commands applicable to the VIRTIS-M sub-unit only.

TC- 21: (PID51, PC12, T193, ST1) MTC\_PEM

The following commands can be issued :

- PEM Switch On
- PEM Switch Off
- PEM Reset

Telecommand Packet Information (VIRTIS)			
Packet name	MTC_PEM	Instrument	VIRTIS
Packet Function	Switch PEM On, Off or Reset		
Verification Rules	Change of state in Default H/K TM		
Header Information			
Process ID	51	Packet Category	12
Service Type	193	Service Subtype	1
Structure ID	N.A.	Packet Length	7
Data Field Information			
Data Field	Field Structure	Remarks	
Switch ID	Enumerated Parameter 16 bits (PTC 2, PFC 16)	BIT 14..15: command Valid range: 1..3 1=Off 2=On 3=Reset BIT 0..13: always 0	
<b>Notes:</b>			
Acceptance Success/Failure Report can be required.			
Execution Success/Failure Report should be required. Execution time is several seconds in case of XTC_PEM(on), depending on duration of the X-Cover initialization procedure			

TC- 22: (PID51, PC12, T193, ST2) MTC\_PEM\_Command\_Word

Telecommand Packet Information (VIRTIS)			
Packet name	MTC_PEM_Command_Word	Instrument	VIRTIS
Packet Function	Transparently send a 16-bit command word to the V-M PEM		
Verification Rules	none		
Header Information			
Process ID	51	Packet Category	12
Service Type	193	Service Subtype	2
Structure ID	N.A.	Packet Length	7
Data Field Information			
Data Field	Field Structure	Remarks	
Command Word	Unsigned Integer 16 bits (PTC 3, PFC 12)	Word transmitted to the PEM by the ME	
<b>Notes:</b>			
Acceptance Success/Failure Report can be required.			
Execution Success/Failure Report shall never be required.			

TC- 23: (PID51, PC12, T193, ST3) MTC\_Cover

The following commands can be issued :

- Cover Open
- Cover Close

Telecommand Packet Information (VIRTIS)			
Packet name	MTC_Cover	Instrument	VIRTIS
Packet Function	Command Cover to Open/Close		
Verification Rules	Normal/Progress Event Report in TM		
Header Information			
Process ID	51	Packet Category	12
Service Type	193	Service Subtype	3
Structure ID	N.A.	Packet Length	7
Data Field Information			
Data Field	Field Structure	Remarks	
Cover Status	Enumerated Parameter 16 bits (PTC 2, PFC 16)	BIT 14..15: command Valid range: 1..2 1=Open 2=Close BIT 0..13: always 0	
<b>Notes:</b>			
Acceptance Success/Failure Report can be required.			
Execution Success/Failure Report should be required. Execution time is about 60sec maximum, depending on functional parameters X_OPEN_COVER_STEP, X_CLOSE_COVER_STEP and X_INIT_COVER_STEP (cover control)			

TC- 24: (PID51, PC12, T193, ST4) MTC\_ECA

The following command can be issued :

- Cover Forced Open

Telecommand Packet Information (VIRTIS)			
Packet name	MTC_ECA	Instrument	VIRTIS
Packet Function	Operate the Emergency Cover Actuator		
Verification Rules	Normal/Progress Event Report in TM		
Header Information			
Process ID	51	Packet Category	12
Service Type	193	Service Subtype	4
Structure ID	N.A.	Packet Length	5
Data Field Information			
Data Field	Field Structure	Remarks	
<b>Notes:</b>			
No data field			
After this command the cover will be no longer available and no other Cover commands can be actuated, therefore they will be not accepted.			
Acceptance Success/Failure Report can be required.			
Execution Success/Failure Report should be required. Eexecution time is several minutes, depending on functional parameter X_ECA_ACT for ECA control			
VTC_Confirm has to be sent immediately after without any other TC commanded between MTC_ECA and VTC_Confirm			

TC- 25: (PID51, PC12, T193, ST5) MTC\_Cooler

The following commands can be issued :

- Cooler On / Open Loop + Motor Speed
- Cooler On / Close Loop + Temperature
- Cooler Off

Telecommand Packet Information (VIRTIS)			
Packet name	MTC_Cooler	Instrument	VIRTIS
Packet Function	Command the Cooler status		
Verification Rules	Cooler temperature in H/K TM		
Header Information			
Process ID	51	Packet Category	12
Service Type	193	Service Subtype	5
Structure ID	N.A.	Packet Length	9
Data Field Information			
Data Field	Field Structure	Remarks	
Cooler Status	Enumerated Parameter 16 bits (PTC 2, PFC 16)	BIT 13..15: command Valid range: 1..4 1=Off 2=On Open Loop 3=On Close Loop 4= Stand-by (+28V on, motor drive off) BIT 0..12: always 0	
Temp/Speed	Unsigned Integer 16 bits (PTC 3, PFC 12)	BIT 4...15: Depending on Coolers Status: If 1=N.A. If 2=Cooler motor speed Valid range 1..3800 [rpm], 1...3800[bit] $a_R=1 \quad b_R=0$ If 3=(Temperature [K] – 60) * 102.375 with Temperature range 60...100 Valid range 60...100[Kelvin], 0..4095[bit] $a_R=102.375 \quad b_R=-6142$ If 4= NA BIT 0..12: always 0	
Notes:			
The $a_R$ and $b_R$ coefficients are referred to the following transfer function $TF: Y_{bit} = a_R * X + b_R$			
Acceptance Success/Failure Report can be required.			
Execution Success/Failure Report shall never be required.			



TC- 26: (PID51, PC12, T193, ST6) MTC\_Annealing

The following commands can be issued :

- Annealing Start + temperature limits
- Annealing Stop

Telecommand Packet Information (VIRTIS)			
Packet name	MTC_Annealing	Instrument	VIRTIS
Packet Function	Start/Stop Annealing on the IR detector		
Verification Rules	Change of state in Default H/K TM		
Header Information			
Process ID	51	Packet Category	12
Service Type	193	Service Subtype	6
Structure ID	N.A.	Packet Length	7
Data Field Information			
Data Field	Field Structure	Remarks	
Command	Enumerated Parameter 16 bits (PTC 2, PFC 16)	BIT 14..15: command Valid range: 1...2 1=Start 2=Stop BIT 0..13: always 0	
<b>Notes:</b>			
Annealing temperature limits are settable using MTC_Change_Func_Param			
Acceptance Success/Failure Report can be required.			
Execution Success/Failure Report shall never be required.			

TC- 27: (PID51, PC12, T193, ST10) MTC\_Default\_Configuration

Telecommand Packet Information (VIRTIS)			
Packet name	MTC_Default_Configuration	Instrument	VIRTIS
Packet Function	Copy from EEPROM to RAM the Default Parameter Set		
Verification Rules	Memory Dump content in TM		
Header Information			
Process ID	51	Packet Category	12
Service Type	193	Service Subtype	10
Structure ID	N.A.	Packet Length	5
Data Field Information			
Data Field	Field Structure	Remarks	
<b>Notes:</b>			
No data field			
Acceptance Success/Failure Report can be required.			
Execution Success/Failure Report shall never be required.			

TC- 28: (PID51, PC12, T193, ST11) MTC\_Change\_Data\_Product\_Param\_RAM

Telecommand Packet Information (VIRTIS)			
Packet name	MTC_Change_Data_Product_Param_RAM	Instrument	VIRTIS
Packet Function	Update the RAM copy of the Data Production Parameter Set		
Verification Rules	Memory Dump content in TM		
Header Information			
Process ID	51	Packet Category	12
Service Type	193	Service Subtype	11
Structure ID	N.A.	Packet Length	7
Data Field Information			
Data Field	Field Structure	Remarks	
M_DPT	Enumerated Parameter 16 bits (PTC 2, PFC 16)	BIT 14..15: Data Production Type: specifies the type of M session to be performed after the start given with the Enable Science Valid range=0..2 Default value=0 0=M_Data_Science 1=M_Data_Calibration 2=M_Data_Test BIT 0..13: Always 0	
<b>Notes:</b>			
Acceptance Success/Failure Report can be required.			
Execution Success/Failure Report shall never be required.			

TC- 29: (PID51, PC12, T193, ST12) MTC\_Change\_Data\_Product\_Param\_RAM\_EEPROM

Telecommand Packet Information (VIRTIS)			
Packet name	MTC_Change_Data_Product_Param_RAM_EEPROM	Instrument	VIRTIS
Packet Function	Update the RAM and EEPROM copies of the Data Production Parameter Set		
Verification Rules	Memory Dump content in TM		
Header Information			
Process ID	51	Packet Category	12
Service Type	193	Service Subtype	12
Structure ID	N.A.	Packet Length	7
Data Field Information			
Data Field	Field Structure	Remarks	
See <a href="#">TC- 28: (PID51, PC12, T193, ST11) MTC_Change_Data_Product_Param_RAM</a>			
<b>Notes:</b>			
Acceptance Success/Failure Report can be required.			
Execution Success/Failure Report shall never be required.			

TC- 30: (PID51, PC12, T193, ST13) MTC\_Change\_Func\_Param\_RAM

Telecommand Packet Information (VIRTIS)			
Packet name	MTC_Change_Func_Param_RAM	Instrument	VIRTIS
Packet Function	Update the RAM copy of the Functional Parameter Set		
Verification Rules	Memory Dump content in TM		
Header Information			
Process ID	51	Packet Category	12
Service Type	193	Service Subtype	13
Structure ID	N.A.	Packet Length	63
Data Field Information			
Data Field	Field Structure	Remarks	
M_IR_WIN_X1	Unsigned Integer 16 bits (PTC 3, PFC 12)	BIT 7..15: X-coordinate of the IR first pixel Valid range=0..437[pixel], 0..437[bit] Default value=1[pixel], 1[bit] A <sub>R</sub> = 1    b <sub>R</sub> =0    unit=pixel BIT 0..6: always 0	
M_IR_WIN_X2	Unsigned Integer 16 bits (PTC 3, PFC 12)	BIT 7..15: X-coordinate of the IR last pixel Valid range=0..437[pixel], 0..437[bit] Default value=432[pixel], 432[bit] A <sub>R</sub> = 1    b <sub>R</sub> =0    unit=pixel BIT 0..6: always 0	
M_IR_WIN_Y1	Unsigned Integer 16 bits (PTC 3, PFC 12)	BIT 7..15: Y-coordinate of the IR first pixel Valid range=0..269[pixel], 0..269[bit] Default value=7[pixel], 7[bit] A <sub>R</sub> = 1    b <sub>R</sub> =0    unit=pixel BIT 0..6: always 0	
M_IR_WIN_Y2	Unsigned Integer 16 bits (PTC 3, PFC 12)	BIT 7..15: Y-coordinate of the IR last pixel Valid range=0.. 269 [pixel], 0.. 269 [bit] Default value=262[pixel], 262[bit] A <sub>R</sub> = 1    b <sub>R</sub> =0    unit=pixel BIT 0..6: always 0	
M_IR_VDETCOM	Unsigned Integer 16 bits (PTC 3, PFC 12)	BIT 4..15: VDETCOM bias voltage Valid range=2.012..4.008[volt], 0..4095[bit] Default value=3.200[volt], 2440[bit] A <sub>R</sub> = 2051.28    b <sub>R</sub> =-4127    unit=volt BIT 0..3: always 0	
M_IR_VDETADJ	Unsigned Integer 16 bits (PTC 3, PFC 12)	BIT 4..15: VDETADJ bias voltage Valid range=0..4.996[volt], 0..4095[bit] Default value=2.700[volt], 2213[bit] A <sub>R</sub> = 819.6    b <sub>R</sub> =-0.246    unit=volt BIT 0..3: always 0	
M_IR_DELAY	Unsigned Integer 16 bits (PTC 3, PFC 12)	BIT 6..15: IR delay time <b>For EM:</b> Valid range=0...102.3[sec], 0..1023[bit] Default value=0.1[sec], 1[bit] A <sub>R</sub> = 10    b <sub>R</sub> =0 <b>For FM:</b> Valid range=0...20.46[sec], 0..1023[bit] Default value=0.1[sec], 5[bit] A <sub>R</sub> = 50    b <sub>R</sub> =0    unit=sec BIT 0..5: always 0	

M_IR_EXPO	Unsigned Integer 16 bits (PTC 3, PFC 12)	BIT 6..15: IR exposure time <b>For EM:</b> Valid range=0...102.3[sec], 0..1023[bit] Default value=0.1[sec], 1[bit] A <sub>R</sub> = 10    b <sub>R</sub> =0 <b>For FM:</b> Valid range=0...20.46[sec], 0..1023[bit] Default value=0.02[sec], 1[bit] A <sub>R</sub> = 50    b <sub>R</sub> =0    unit=sec BIT 0..5: always 0
M_CCD_WIN_X1	Unsigned Integer 16 bits (PTC 3, PFC 12)	BIT 7..15: X-coordinate of the CCD first pixel Valid range=0..437[pixel], 0..437[bit] Default value=5[pixel], 5[bit] A <sub>R</sub> = 1    b <sub>R</sub> =0    unit=pixel BIT 0..6: always 0
M_CCD_WIN_X2	Unsigned Integer 16 bits (PTC 3, PFC 12)	BIT 7..15: X-coordinate of the CCD last pixel Valid range=0..437[pixel], 0..437[bit] Default value=436[pixel], 436[bit] A <sub>R</sub> = 1    b <sub>R</sub> =0    unit=pixel BIT 0..6: always 0
M_CCD_WIN_Y1	Unsigned Integer 16 bits (PTC 3, PFC 12)	BIT 8..15: Y-coordinate of the CCD first pixel Valid range=0..255[pixel], 0..255[bit] Default value=0[pixel], 0[bit] A <sub>R</sub> = 1    b <sub>R</sub> =0    unit=pixel BIT 0..7: always 0
M_CCD_WIN_Y2	Unsigned Integer 16 bits (PTC 3, PFC 12)	BIT 8..15: Y-coordinate of the CCD last pixel Valid range=0.. 255 [pixel], 0.. 255 [bit] Default value=255[pixel], 255[bit] A <sub>R</sub> = 1    b <sub>R</sub> =0    unit=pixel BIT 0..7: always 0
M_CCD_DELAY	Unsigned Integer 16 bits (PTC 3, PFC 12)	BIT 6..15: CCD delay time <b>For EM:</b> Valid range=0.1...102.3[sec], 1..1023[bit] Default value=0.1[sec], 1[bit] A <sub>R</sub> = 10    b <sub>R</sub> =0 <b>For FM:</b> Valid range=0.1...20.46[sec], 5..1023[bit] Default value=0.1[sec], 5[bit] A <sub>R</sub> = 50    b <sub>R</sub> =0    unit=sec BIT 0..5: always 0
M_CCD_EXPO	Unsigned Integer 16 bits (PTC 3, PFC 12)	BIT 6..15: CCD exposure time <b>For EM:</b> Valid range=0...102.3[sec], 0..1023[bit] Default value=0.1[sec], 1[bit] A <sub>R</sub> = 10    b <sub>R</sub> =0 <b>For FM:</b> Valid range=0...20.46[sec], 0..1023[bit] Default value=0.02[sec], 1[bit] A <sub>R</sub> = 50    b <sub>R</sub> =0    unit=sec BIT 0..5: always 0

M_SU	Enumerated Parameter 16 bits (PTC 2, PFC 16)	<b>For EM:</b> BIT 15..15: scan mirror mode Valid range=0..2 Default value=2 0=Point 1=Scan 2=Off (this value is accepted, but not executed) BIT 0..13: always 0 <b>For FM:</b> BIT 14..15: scan mirror mode Valid range=0..2 Default value=2 0=Point 1=Scan 2=Off BIT 0..13: always 0
M_α <sub>first</sub>	Unsigned Integer 16 bits (PTC 3, PFC 12)	BIT 0..15: if SU mode = point, pointed angle Valid range=-36...+36[deg el angle], 0..65535[bit] Default value=4.9[deg], 37228 [bit] A <sub>R</sub> = 910.2 b <sub>R</sub> =32768 unit=el. angle if SU mode = scan, first angle Valid range=-36...+36[deg el angle], 0..65535[bit] Default value=-30.213[deg], 5268[bit] A <sub>R</sub> = 910.2 b <sub>R</sub> =32768 unit=el. angle
M_α <sub>last</sub>	Unsigned Integer 16 bits (PTC 3, PFC 12)	BIT 0..15: if SU mode = point, don't care if SU mode = scan, last angle Valid range=-36...+36[deg el angle], 0..65535[bit] Default value=+35.621[deg], 65193[bit] A <sub>R</sub> = 910.2 b <sub>R</sub> =32768 unit=el. angle
M_Δα	Unsigned Integer 16 bits (PTC 3, PFC 12)	BIT 0..15: if SU mode = point, don't care if SU mode = scan, angle step Valid range=0...71.99[deg el angle], 1..65535[bit] Default value=0.258[deg], 235[bit] A <sub>R</sub> = 910.2 b <sub>R</sub> =0 unit=el. angle
M_Nα <sub>IRT</sub>	Unsigned Integer 16 bits (PTC 3, PFC 12)	BIT 0..15: if SU mode = point, don't care if SU mode =scan,# of IRT with the same angle, Valid range=1...65535[#], 1..65535[bit] Default value=1[#], 1[bit] a <sub>d</sub> = 1 b <sub>d</sub> =0 unit= frame
M_D/BCK_RATE	Unsigned Integer 16 bits (PTC 3, PFC 12)	BIT 0..15: dark acquisition rate number Valid range=1...65535[#], 1..65535[bit] Default value=20[#], 20[bit] a <sub>d</sub> = 1 b <sub>d</sub> =0 unit= frame
M_SHUTT_CURR	Unsigned Integer 16 bits (PTC 3, PFC 12)	<b>For EM:</b> BIT 12..15: shutter current Valid range=41...56[mA], 0..15[bit] Default value=47[mA], 6[bit] a <sub>d</sub> = 1 b <sub>d</sub> = -41 unit=mA BIT 0..11: always 0 <b>For FM:</b> BIT 12..15: shutter current Valid range=45...60[mA], 0..15[bit] Default value=53[mA], 8[bit] a <sub>d</sub> = 1 b <sub>d</sub> = -45 unit=mA BIT 0..11: always 0

M_SHUTT_STAB	Unsigned Integer 16 bits (PTC 3, PFC 12)	BIT 8..15: shutter stab time Valid range=1...255[ms], 1..255[bit] Default value=50[ms], 50[bit] $a_d=1$ $b_d=0$ unit=ms BIT 0..7: always 0
M_ANN_LIMITS	Unsigned Integer 16 bits (PTC 3, PFC 12)	BIT 10..15: Annealing temperature limits Valid range=+38...-13[°C], 0..63[bit] Default value=-13[°C], 63[bit] $a_d=-1.2353$ $b_d=46.9425$ unit=C° BIT 0..9: always 0
M_ANN_T_OUT	Unsigned Integer 16 bits (PTC 3, PFC 12)	BIT 6..15: Annealing timeout Valid range=1..1023[min], 1..1023[bit] Default value=360[min], 360[bit] $a_d=1$ $b_d=0$ unit=minutes BIT 0..5: always 0
M_ECA_ACT	Unsigned Integer 16 bits (PTC 3, PFC 12)	BIT 8..15: ECA actuation time Valid range=1..255[min], 1..255[bit] Default value=30[min], 30[bit] $a_d=1$ $b_d=0$ unit=minutes BIT 0..7: always 0
OPEN_COVER_STEPS	Unsigned Integer 16 bits (PTC 3, PFC 12)	BIT 9..15: # steps for cover open Valid range=1..127[step], 1..127[bit] Default value=81[step], 81[bit] $a_d=1$ $b_d=0$ unit=steps BIT 0..8: always 0
M_IR_DET_OFF	Unsigned Integer 16 bits (PTC 3, PFC 12)	BIT 8..15: IR detector On/Off modality 0xFF means the M-IR detector is <u>not</u> switch-on (in -M data acquisition modes) otherwise it is switched-on BIT 0..8: always 0
CLOSE_COVER_STEPS	Unsigned Integer 16 bits (PTC 3, PFC 12)	BIT 9..15: # steps for cover close Valid range=1..127[step], 1..127[bit] Default value=120[step], 120[bit] $a_d=1$ $b_d=0$ unit=steps BIT 0..8: always 0
INIT_COVER_STEPS	Unsigned Integer 16 bits (PTC 3, PFC 12)	BIT 9..15: # steps for cover init Valid range=1..127[step], 1..127[bit] Default value=16[step], 16[bit] $a_d=1$ $b_d=0$ unit=steps BIT 0..8: always 0

**Notes:**

The  $a_R$  and  $b_R$  coefficients are referred to the following transfer function

$$TF: \quad Y_{bit} = a_R * X + b_R$$

Acceptance Success/Failure Report can be required.

Execution Success/Failure Report shall never be required.

$M_{\alpha_{first}} = 4.9[\text{deg}]$ , Corresponds to boresight (default value when SU mode is point); the value should be updated after on ground calibration.

$M_{\alpha_{first}} = +33.047^\circ$  of electrical angle corresponds to +32 mrad of optical angle (a complete scan is from -32 to +32 mrad optical).

$M_{\Delta\alpha} = 0.2582 [\text{deg}]$  of electrical angle corresponds. to 250  $\mu\text{rad}$  of optical angle which is the nominal step angle.

Example of scan with default values

1step: @ pos. 5268 (M\_SU\_ANGLE\_FIRST)

2step: @ pos. 5503 (M\_SU\_ANGLE\_FIRST + M\_SU\_ANGLE\_STEP\_SIZE)

.....

256step: @ pos. 65193 (M\_SU\_ANGLE\_FIRST + 255\*M\_SU\_ANGLE\_STEP\_SIZE)

257step: @ pos. 65428 (step performed because 65193 < 65193+235/2)

258step: @ pos. 5268 (goes back because 65428 > 65193+235/2).

TC- 31: (PID51, PC12, T193, ST14) MTC\_Change\_Func\_Param\_RAM\_EEPROM

Telecommand Packet Information (VIRTIS)			
Packet name	MTC_Change_Func_Param_RAM_EEPROM	Instrument	VIRTIS
Packet Function	Update the RAM and EEPROM copies of the Functional Parameter Set		
Verification Rules	Memory Dump content in TM		
Header Information			
Process ID	51	Packet Category	12
Service Type	193	Service Subtype	14
Structure ID	N.A.	Packet Length	63
Data Field Information			
Data Field	Field Structure	Remarks	
See TC- 30: (PID51, PC12, T193, ST13) MTC_Change_Func_Param_RAM			
Notes:			
Acceptance Success/Failure Report can be required.			
Execution Success/Failure Report shall never be required.			



TC- 32: (PID51, PC12, T193, ST15) MTC\_Change\_Oper\_Param\_RAM

Telecommand Packet Information (VIRTIS)			
Packet name	MTC_Change_Oper_Param_RAM	Instrument	VIRTIS
Packet Function	Update the RAM copy of the Operative Parameter Set		
Verification Rules	Memory Dump content in TM		
Header Information			
Process ID	51	Packet Category	12
Service Type	193	Service Subtype	15
Structure ID	N.A.	Packet Length	13
Data Field Information			
Data Field	Field Structure	Remarks	
M_ERT	Enumerated Parameter 16 bits (PTC 2, PFC 16)	<b>For EM:</b> BIT 14..15 : External Repetition Time i.e. the repetition time of a Composite Acquisition Cycle Valid range=0...3 Default value=0 0=5sec 1=20sec 2=60sec 3=300sec BIT 0..13= always 0 <b>For FM:</b> BIT 13..15 : External Repetition Time i.e. the repetition time of a Composite Acquisition Cycle Valid range=0...5 Default value=0 0=5sec 1=20sec 2=60sec 3=300sec 4=2.5sec 5=10sec BIT 0..12= always 0	
M_SS	Unsigned Integer 16 bits (PTC 3, PFC 12)	BIT 14..15 : Slice Summing Valid range=1..65535[slice], 1..65535[bit] Default value=1[slice], 1[bit] $a_d=1$ $b_d=0$ BIT 0..13= always 0	
M_ACQ_MODE	Enumerated Parameter 16 bits (PTC 2, PFC 16)	BIT 13..15: Acquisition Mode Valid range=0...7 Default value=0 0=nominal (3x4, full window) 1=VIS only (1x4) 2=IR only (1x4) 3=high spectral (1x4, full window) 4=high spatial (3x1, full window) 5=all_pix (no binning, full window) 6=Reduced Slit (3x1) 7=Alternate (IR only, 1x4) BIT 0..12= always 0	



M_COMPR	Enumerated Parameter 16 bits (PTC 2, PFC 16)	BIT 13..15 Valid range=0...4 Default value=1 0=no compression 1=lossless 2=wavelet 2 bit/datum 3 =wavelet 1.5 bit/datum 4=wavelet 1 bit/datum BIT 0..12= always 0
<p>Notes:</p> <p>The <math>a_R</math> and <math>b_R</math> coefficients are referred to the following transfer function  TF: <math>Y_{bit} = a_R * X + b_R</math></p> <p>Acceptance Success/Failure Report can be required.  Execution Success/Failure Report shall never be required.</p> <p><math>M_{IRT} = M_{ERT} / M_{SS}</math>; the ME shall check that this value is compatible with <math>M_{IR\_D}</math>, <math>M_{IR\_XP}</math>, <math>M_{VIS\_D}</math> e <math>M_{VIS\_XP}</math> (<math>M_{IR\_D}</math>, <math>M_{IR\_XP}</math>, <math>M_{IR1\_D}</math> e <math>M_{IR1\_XP}</math> for the alternate mode)</p> <p>Type of the window in output from the instrument :  full : IR (432 x 256) &amp; VIS (432 x 256)  calibration : IR (432 x 256) &amp; VIS ( 432 x 256)  Reduced Slit : only 64 pixels along the spatial direction for both detectors  VIS only : only 288 VIS wavelength  IR only : only 288 IR wavelength</p>		

TC- 33: (PID51, PC12, T193, ST16) MTC\_Change\_Oper\_Param\_RAM\_EEPROM

Telecommand Packet Information (VIRTIS)			
Packet name	MTC_Change_Oper_Param_RAM_EEPROM	Instrument	VIRTIS
Packet Function	Update the RAM and EEPROM copies of the Operative Parameter Set		
Verification Rules	Memory Dump content in TM		
Header Information			
Process ID	51	Packet Category	12
Service Type	193	Service Subtype	16
Structure ID	N.A.	Packet Length	13
Data Field Information			
Data Field	Field Structure	Remarks	
See TC- 32: (PID51, PC12, T193, ST15) MTC_Change_Oper_Param_RAM			
Notes:			
Acceptance Success/Failure Report can be required.			
Execution Success/Failure Report shall never be required.			

TC- 34: (PID51, PC12, T193, ST17) MTC\_Change\_Cal\_Param\_RAM

Telecommand Packet Information (VIRTIS)			
Packet name	MTC_Change_Cal_Param_RAM	Instrument	VIRTIS
Packet Function	Update the RAM copy of the Calibration Parameter Set		
Verification Rules	Memory Dump content in TM		
Header Information			
Process ID	51	Packet Category	12
Service Type	193	Service Subtype	17
Structure ID	N.A.	Packet Length	61
Data Field Information			
Data Field	Field Structure	Remarks	
M_IR_DELAY1	Unsigned Integer 16 bits (PTC 3, PFC 12)	BIT 6..15: IR delay time phase 1 <b>For EM:</b> Valid range=0...102.3[sec], 0..1023[bit] Default value=9.8[sec], 98[bit] A <sub>R</sub> = 10 b <sub>R</sub> =0 <b>For FM:</b> Valid range=0...20.46[sec], 0..1023[bit] Default value=9.8[sec], 490[bit] A <sub>R</sub> = 50 b <sub>R</sub> =0 BIT 0..5: always 0	
M_IR_DELAY2	Unsigned Integer 16 bits (PTC 3, PFC 12)	BIT 6..15: IR delay time phase 2 <b>For EM:</b> Valid range=0...102.3[sec], 0..1023[bit] Default value=9.8[sec], 98[bit] A <sub>R</sub> = 10 b <sub>R</sub> =0 <b>For FM:</b> Valid range=0...20.46[sec], 0..1023[bit] Default value=9.8[sec], 490[bit] A <sub>R</sub> = 50 b <sub>R</sub> =0 BIT 0..5: always 0	
M_IR_DELAY3	Unsigned Integer 16 bits (PTC 3, PFC 12)	BIT 6..15: IR delay time phase 3 <b>For EM:</b> Valid range=0...102.3[sec], 0..1023[bit] Default value=9.8[sec], 98[bit] A <sub>R</sub> = 10 b <sub>R</sub> =0 <b>For FM:</b> Valid range=0...20.46[sec], 0..1023[bit] Default value=9.8[sec], 490[bit] A <sub>R</sub> = 50 b <sub>R</sub> =0 BIT 0..5: always 0	
M_IR_DELAY4	Unsigned Integer 16 bits (PTC 3, PFC 12)	BIT 6..15: IR delay time phase 4 <b>For EM:</b> Valid range=0...102.3[sec], 0..1023[bit] Default value=0.3[sec], 3[bit] A <sub>R</sub> = 10 b <sub>R</sub> =0 <b>For FM:</b> Valid range=0...20.46[sec], 0..1023[bit] Default value=0.3[sec], 15[bit] A <sub>R</sub> = 50 b <sub>R</sub> =0 BIT 0..5: always 0	

M_IR_DELAY5	Unsigned Integer 16 bits (PTC 3, PFC 12)	BIT 6..15: IR delay time phase 5 <b>For EM:</b> Valid range=0...102.3[sec], 0..1023[bit] Default value=9.8[sec], 98[bit] $A_R = 10$ $b_R = 0$ <b>For FM:</b> Valid range=0...20.46[sec], 0..1023[bit] Default value=9.8[sec], 490[bit] $A_R = 50$ $b_R = 0$ BIT 0..5: always 0
M_IR_DELAY6	Unsigned Integer 16 bits (PTC 3, PFC 12)	BIT 6..15: IR delay time phase 6 <b>For EM:</b> Valid range=0...102.3[sec], 0..1023[bit] Default value=9.8[sec], 98[bit] $A_R = 10$ $b_R = 0$ <b>For FM:</b> Valid range=0...20.46[sec], 0..1023[bit] Default value=9.8[sec], 490[bit] $A_R = 50$ $b_R = 0$ BIT 0..5: always 0
M_IR_EXPO1	Unsigned Integer 16 bits (PTC 3, PFC 12)	BIT 6..15: IR exposure time phase 1 <b>For EM:</b> Valid range=0...102.3[sec], 0..1023[bit] Default value=0.5[sec], 5[bit] $A_R = 10$ $b_R = 0$ <b>For FM:</b> Valid range=0...20.46[sec], 0..1023[bit] Default value=0.5[sec], 25[bit] $A_R = 50$ $b_R = 0$ BIT 0..5: always 0
M_IR_EXPO2	Unsigned Integer 16 bits (PTC 3, PFC 12)	BIT 6..15: IR exposure time phase 2 <b>For EM:</b> Valid range=0...102.3[sec], 0..1023[bit] Default value=0.5[sec], 5[bit] $A_R = 10$ $b_R = 0$ <b>For FM:</b> Valid range=0...20.46[sec], 0..1023[bit] Default value=0.5[sec], 25[bit] $A_R = 50$ $b_R = 0$ BIT 0..5: always 0
M_IR_EXPO3	Unsigned Integer 16 bits (PTC 3, PFC 12)	BIT 6..15: IR exposure time phase 3 <b>For EM:</b> Valid range=0...102.3[sec], 0..1023[bit] Default value=0.5[sec], 5[bit] $A_R = 10$ $b_R = 0$ <b>For FM:</b> Valid range=0...20.46[sec], 0..1023[bit] Default value=0.5[sec], 25[bit] $A_R = 50$ $b_R = 0$ BIT 0..5: always 0
M_IR_EXPO4	Unsigned Integer 16 bits (PTC 3, PFC 12)	BIT 6..15: IR exposure time phase 4 <b>For EM:</b> Valid range=0...102.3[sec], 0..1023[bit] Default value=0.1[sec], 1[bit] $A_R = 10$ $b_R = 0$ <b>For FM:</b> Valid range=0...20.46[sec], 0..1023[bit] Default value=0.02[sec], 1[bit] $A_R = 50$ $b_R = 0$ BIT 0..5: always 0

M_IR_EXPO5	Unsigned Integer 16 bits (PTC 3, PFC 12)	BIT 6..15: IR exposure time phase 5 <b>For EM:</b> Valid range=0...102.3[sec], 0..1023[bit] Default value=0.5[sec], 5[bit] A <sub>R</sub> = 10 b <sub>R</sub> =0 <b>For FM:</b> Valid range=0...20.46[sec], 0..1023[bit] Default value=0.5[sec], 25[bit] A <sub>R</sub> = 50 b <sub>R</sub> =0 BIT 0..5: always 0
M_IR_EXPO6	Unsigned Integer 16 bits (PTC 3, PFC 12)	BIT 6..15: IR exposure time phase 6 <b>For EM:</b> Valid range=0...102.3[sec], 0..1023[bit] Default value=0.5[sec], 5[bit] A <sub>R</sub> = 10 b <sub>R</sub> =0 <b>For FM:</b> Valid range=0...20.46[sec], 0..1023[bit] Default value=0.5[sec], 25[bit] A <sub>R</sub> = 50 b <sub>R</sub> =0 BIT 0..5: always 0
M_IR_L_STAB	Unsigned Integer 16 bits (PTC 3, PFC 12)	BIT 0..15: time needed to stabilize the IR calibration lamp Valid range=1...6553.5[sec], 1..65535[bit] Default value=60[sec], 600[bit] A <sub>R</sub> = 10 b <sub>R</sub> =0
M_IR_L_CURR	Enumerated Parameter 16 bits (PTC 2, PFC 16)	<b>For EM:</b> BIT 6..15: IR calibration lamp current Valid range=194...209[mA], 0..15[bit] Default value=200[mA], 6[bit] A <sub>R</sub> = 1 b <sub>R</sub> = -194 BIT 0..5: always 0 <b>For FM:</b> BIT 6..15: IR calibration lamp current Valid range=94...109[mA], 0..15[bit] Default value=100[mA], 6[bit] A <sub>R</sub> = 1 b <sub>R</sub> = -94 BIT 0..5: always 0
M_CCD_DELAY1	Unsigned Integer 16 bits (PTC 3, PFC 12)	BIT 6..15: CCD delay time phase 1 <b>For EM:</b> Valid range=0.1...102.3[sec], 1..1023[bit] Default value=0.1[sec], 1[bit] A <sub>R</sub> = 10 b <sub>R</sub> =0 <b>For FM:</b> Valid range=0.1...20.46[sec], 5..1023[bit] Default value=0.1[sec], 5[bit] A <sub>R</sub> = 50 b <sub>R</sub> =0 BIT 0..5: always 0
M_CCD_DELAY2	Unsigned Integer 16 bits (PTC 3, PFC 12)	BIT 6..15: CCD delay time phase 2 <b>For EM:</b> Valid range=0.1...102.3[sec], 1..1023[bit] Default value=0.1[sec], 1[bit] A <sub>R</sub> = 10 b <sub>R</sub> =0 <b>For FM:</b> Valid range=0.1...20.46[sec], 5..1023[bit] Default value=0.1[sec], 5[bit] A <sub>R</sub> = 50 b <sub>R</sub> =0 BIT 0..5: always 0

M_CCD_DELAY3	Unsigned Integer 16 bits (PTC 3, PFC 12)	BIT 6..15: CCD delay time phase 3 <b>For EM:</b> Valid range=0.1...102.3[sec], 1..1023[bit] Default value=0.1[sec], 1[bit] $A_R = 10$ $b_R = 0$ <b>For FM:</b> Valid range=0.1...20.46[sec], 5..1023[bit] Default value=0.1[sec], 5[bit] $A_R = 50$ $b_R = 0$ BIT 0..5: always 0
M_CCD_DELAY4	Unsigned Integer 16 bits (PTC 3, PFC 12)	BIT 6..15: CCD delay time phase 4 <b>For EM:</b> Valid range=0.1...102.3[sec], 1..1023[bit] Default value=0.1[sec], 1[bit] $A_R = 10$ $b_R = 0$ <b>For FM:</b> Valid range=0.1...20.46[sec], 5..1023[bit] Default value=0.1[sec], 5[bit] $A_R = 50$ $b_R = 0$ BIT 0..5: always 0
M_CCD_DELAY5	Unsigned Integer 16 bits (PTC 3, PFC 12)	BIT 6..15: CCD delay time phase 5 <b>For EM:</b> Valid range=0.1...102.3[sec], 1..1023[bit] Default value=0.1[sec], 1[bit] $A_R = 10$ $b_R = 0$ <b>For FM:</b> Valid range=0.1...20.46[sec], 5..1023[bit] Default value=0.1[sec], 5[bit] $A_R = 50$ $b_R = 0$ BIT 0..5: always 0
M_CCD_DELAY6	Unsigned Integer 16 bits (PTC 3, PFC 12)	BIT 6..15: CCD delay time phase 6 <b>For EM:</b> Valid range=0.1...102.3[sec], 1..1023[bit] Default value=0.1[sec], 1[bit] $A_R = 10$ $b_R = 0$ <b>For FM:</b> Valid range=0.1...20.46[sec], 5..1023[bit] Default value=0.1[sec], 5[bit] $A_R = 50$ $b_R = 0$ BIT 0..5: always 0
M_CCD_EXPO1	Unsigned Integer 16 bits (PTC 3, PFC 12)	BIT 6..15: CCD exposure time phase 1 <b>For EM:</b> Valid range=0...102.3[sec], 0..1023[bit] Default value=1[sec], 10[bit] $A_R = 10$ $b_R = 0$ <b>For FM:</b> Valid range=0...20.46[sec], 0..1023[bit] Default value=1[sec], 50[bit] $A_R = 50$ $b_R = 0$ BIT 0..5: always 0
M_CCD_EXPO2	Unsigned Integer 16 bits (PTC 3, PFC 12)	BIT 6..15: CCD exposure time phase 2 <b>For EM:</b> Valid range=0...102.3[sec], 0..1023[bit] Default value=1[sec], 10[bit] $A_R = 10$ $b_R = 0$ <b>For FM:</b> Valid range=0...20.46[sec], 0..1023[bit] Default value=1[sec], 50[bit] $A_R = 50$ $b_R = 0$ BIT 0..5: always 0

M_CCD_EXPO3	Unsigned Integer 16 bits (PTC 3, PFC 12)	BIT 6..15: CCD exposure time phase 3 <b>For EM:</b> Valid range=0...102.3[sec], 0..1023[bit] Default value=20[sec], 200[bit] $A_R = 10$ $b_R = 0$ <b>For FM:</b> Valid range=0...20.46[sec], 0..1023[bit] Default value=20[sec], 1000[bit] $A_R = 50$ $b_R = 0$ BIT 0..5: always 0
M_CCD_EXPO4	Unsigned Integer 16 bits (PTC 3, PFC 12)	BIT 6..15: CCD exposure time phase 4 <b>For EM:</b> Valid range=0...102.3[sec], 0..1023[bit] Default value=1[sec], 10[bit] $A_R = 10$ $b_R = 0$ <b>For FM:</b> Valid range=0...20.46[sec], 0..1023[bit] Default value=1[sec], 50[bit] $A_R = 50$ $b_R = 0$ BIT 0..5: always 0
M_CCD_EXPO5	Unsigned Integer 16 bits (PTC 3, PFC 12)	BIT 6..15: CCD exposure time phase 5 <b>For EM:</b> Valid range=0...102.3[sec], 0..1023[bit] Default value=1[sec], 10[bit] $A_R = 10$ $b_R = 0$ <b>For FM:</b> Valid range=0...20.46[sec], 0..1023[bit] Default value=1[sec], 50[bit] $A_R = 50$ $b_R = 0$ BIT 0..5: always 0
M_CCD_EXPO6	Unsigned Integer 16 bits (PTC 3, PFC 12)	BIT 6..15: CCD exposure time phase 6 <b>For EM:</b> Valid range=0...102.3[sec], 0..1023[bit] Default value=1[sec], 10[bit] $A_R = 10$ $b_R = 0$ <b>For FM:</b> Valid range=0...20.46[sec], 0..1023[bit] Default value=0.5[sec], 25[bit] $A_R = 50$ $b_R = 0$ BIT 0..5: always 0
M_CCD_L_STAB	Unsigned Integer 16 bits (PTC 3, PFC 12)	BIT 0..15: time needed to stabilize the CCD calibration lamp Valid range=1...6553.5[sec], 1..65535[bit] Default value=60[sec], 600[bit] $A_R = 10$ $b_R = 0$
M_CCD_L_CURR	Enumerated Parameter 16 bits (PTC 2, PFC 16)	BIT 12..15: CCD lamp current Valid range=0..3 Default value=2 0=240mA 1=244mA 2=250mA 3=255mA BIT 0..11: always 0

**Notes:**

 The  $a_R$  and  $b_R$  coefficients are referred to the following transfer function

$$TF: Y_{bit} = a_R * X + b_R$$

Acceptance Success/Failure Report can be required.

Execution Success/Failure Report shall never be required.

TC- 35: (PID51, PC12, T193, ST18) MTC\_Change\_Cal\_Param\_RAM\_EEPROM

<b>Telecommand Packet Information (VIRTIS)</b>			
Packet name	MTC_Change_Cal_Param_RAM_EEPROM	Instrument	VIRTIS
Packet Function	Update the RAM and EEPROM copies of the Calibration Parameter Set		
Verification Rules	Memory Dump content in TM		
<b>Header Information</b>			
Process ID	51	Packet Category	12
Service Type	193	Service Subtype	18
Structure ID	N.A.	Packet Length	61
<b>Data Field Information</b>			
Data Field	Field Structure	Remarks	
See <b>TC- 34: (PID51, PC12, T193, ST17) MTC_Change_Cal_Param_RAM</b>			
Notes: Acceptance Success/Failure Report can be required. Execution Success/Failure Report shall never be required.			



TC- 36: (PID51, PC12, T193, ST19) MTC\_Change\_Altern\_Param\_RAM

Telecommand Packet Information (VIRTIS)			
Packet name	MTC_Change_Altern_Param_RAM	Instrument	VIRTIS
Packet Function	Update the RAM copy of the Alternate Parameter Set		
Verification Rules	Memory Dump content in TM		
Header Information			
Process ID	51	Packet Category	12
Service Type	193	Service Subtype	19
Structure ID	N.A.	Packet Length	17
Data Field Information			
Data Field	Field Structure	Remarks	
M_IR_WIN_X1	Unsigned Integer 16 bits (PTC 3, PFC 12)	BIT 7..15: X-coordinate of the IR first pixel Valid range=0..437[pixel], 0..437[bit] Default value=1[pixel], 1[bit] A <sub>R</sub> = 1    b <sub>R</sub> =0    unit=pixel BIT 0..6: always 0	
M_IR_WIN_X2	Unsigned Integer 16 bits (PTC 3, PFC 12)	BIT 7..15: X-coordinate of the IR last pixel Valid range=0..437[pixel], 0..437[bit] Default value=432[pixel], 432[bit] A <sub>R</sub> = 1    b <sub>R</sub> =0    unit=pixel BIT 0..6: always 0	
M_IR_WIN_Y1	Unsigned Integer 16 bits (PTC 3, PFC 12)	BIT 7..15: Y-coordinate of the IR first pixel Valid range=0..269[pixel], 0..269[bit] Default value=7[pixel], 7[bit] A <sub>R</sub> = 1    b <sub>R</sub> =0    unit=pixel BIT 0..6: always 0	
M_IR_WIN_Y2	Unsigned Integer 16 bits (PTC 3, PFC 12)	BIT 7..15: Y-coordinate of the IR last pixel Valid range=0.. 269 [pixel], 0.. 269 [bit] Default value=262[pixel], 262[bit] A <sub>R</sub> = 1    b <sub>R</sub> =0 BIT 0..6: always 0	
M_IR_DELAY	Unsigned Integer 16 bits (PTC 3, PFC 12)	BIT 6..15: IR delay time <b>For EM:</b> Valid range=0...102.3[sec], 0..1023[bit] Default value=0.1[sec], 1[bit] A <sub>R</sub> = 10    b <sub>R</sub> =0 <b>For FM:</b> Valid range=0...20.46[sec], 0..1023[bit] Default value=0.1[sec], 5[bit] A <sub>R</sub> = 50    b <sub>R</sub> =0 BIT 0..5: always 0	
M_IR_EXPO	Unsigned Integer 16 bits (PTC 3, PFC 12)	BIT 6..15: IR exposure time <b>For EM:</b> Valid range=0...102.3[sec], 0..1023[bit] Default value=0.1[sec], 1[bit] A <sub>R</sub> = 10    b <sub>R</sub> =0 <b>For FM:</b> Valid range=0...20.46[sec], 0..1023[bit] Default value=0.1[sec], 5[bit] A <sub>R</sub> = 50    b <sub>R</sub> =0 BIT 0..5: always 0	
<b>Notes:</b>			
The a <sub>R</sub> and b <sub>R</sub> coefficients are referred to the following transfer function $TF: \quad Y_{bit} = a_R * X + b_R$			
Acceptance Success/Failure Report can be required.			
Execution Success/Failure Report shall never be required.			

TC- 37: (PID51, PC12, T193, ST20) MTC\_Change\_Altern\_Param\_RAM\_EEPROM

Telecommand Packet Information (VIRTIS)			
Packet name	MTC_Change_Altern_Param_RAM_EEPROM	Instrument	VIRTIS
Packet Function	Update the RAM and EEPROM copies of the Alternate Parameter Set		
Verification Rules	Memory Dump content in TM		
Header Information			
Process ID	51	Packet Category	12
Service Type	193	Service Subtype	20
Structure ID	N.A.	Packet Length	17
Data Field Information			
Data Field	Field Structure	Remarks	
See TC- 36: (PID51, PC12, T193, ST19) MTC_Change_Altern_Param_RAM			
Notes:			
Acceptance Success/Failure Report can be required.			
Execution Success/Failure Report shall never be required.			

### 3.2.2.8 Service 194 – VIRTIS-H Common Private TCs

This service provides commands applicable to the VIRTIS-H sub-unit only.

TC- 38: (PID51, PC12, T194, ST1) HTC\_PEM

The following commands can be issued :

- PEM Switch On
- PEM Switch Off
- PEM Reset

Telecommand Packet Information (VIRTIS)			
Packet name	HTC_PEM	Instrument	VIRTIS
Packet Function	Switch PEM On, Off or Reset		
Verification Rules	Change of state in Default H/K TM		
Header Information			
Process ID	51	Packet Category	12
Service Type	194	Service Subtype	1
Structure ID	N.A.	Packet Length	7
Data Field Information			
Data Field	Field Structure	Remarks	
Switch ID	Enumerated Parameter 16 bits (PTC 2, PFC 16)	BIT 14..15: command Valid range: 1..3 1=Off 2=On 3=Reset BIT 0..13: always 0	
<b>Notes:</b>			
Acceptance Success/Failure Report can be required.			
Execution Success/Failure Report should be required. Execution time is several seconds in case of XTC_PEM(on), depending on duration of the X-Cover initialization procedure			

TC- 39: (PID51, PC12, T194, ST2) HTC\_PEM\_Command\_Word

Telecommand Packet Information (VIRTIS)			
Packet name	HTC_PEM_Command_Word	Instrument	VIRTIS
Packet Function	Transparently send a 16-bit command word to the V-H PEM		
Verification Rules	none		
Header Information			
Process ID	51	Packet Category	12
Service Type	194	Service Subtype	2
Structure ID	N.A.	Packet Length	7
Data Field Information			
Data Field	Field Structure	Remarks	
Command Word	Unsigned Integer 16 bits (PTC 3, PFC 12)	Request transmitted to the PEM by the ME	
<b>Notes:</b>			
Acceptance Success/Failure Report can be required.			
Execution Success/Failure Report shall never be required.			

TC- 40: (PID51, PC12, T194, ST3) HTC\_Cover

The following commands can be issued :

- Cover Open
- Cover Close

Telecommand Packet Information (VIRTIS)			
Packet name	HTC_Cover	Instrument	VIRTIS
Packet Function	Command Cover to Open/Close		
Verification Rules	Normal/Progress Event Report in TM		
Header Information			
Process ID	51	Packet Category	12
Service Type	194	Service Subtype	3
Structure ID	N.A.	Packet Length	7
Data Field Information			
Data Field	Field Structure	Remarks	
Cover Status	Enumerated Parameter 16 bits (PTC 2, PFC 8)	BIT 14..15: command Valid range: 1..2 1=Open 2=Close BIT 0..13: always 0	
<b>Notes:</b>			
Acceptance Success/Failure Report can be required.			
Execution Success/Failure Report should be required. Execution time is about 60sec maximum, depending on functional parameters X_OPEN_COVER_STEP, X_CLOSE_COVER_STEP and X_INIT_COVER_STEP (cover control)			

TC- 41: (PID51, PC12, T194, ST4) HTC\_ECA

The following command can be issued :

- Cover Forced Open

Telecommand Packet Information (VIRTIS)			
Packet name	HTC_ECA	Instrument	VIRTIS
Packet Function	Operate the Emergency Cover Actuator		
Verification Rules	Normal/Progress Event Report in TM		
Header Information			
Process ID	51	Packet Category	12
Service Type	194	Service Subtype	4
Structure ID	N.A.	Packet Length	5
Data Field Information			
Data Field	Field Structure	Remarks	
<b>Notes:</b>			
No data field			
After this command the cover will be no longer available and no other Cover commands can be actuated, therefore they will be not accepted.			
Acceptance Success/Failure Report can be required.			
Execution Success/Failure Report should be required. Execution time is several minutes, depending on functional parameter X_ECA_ACT for ECA control			
VTC_Confirm has to be sent immediately after without any other TC commanded between HTC_ECA and VTC_Confirm			

TC- 42: (PID51, PC12, T194, ST5) HTC\_Cooler

The following commands can be issued :

- Cooler On / Open Loop + Motor Speed
- Cooler On / Close Loop + Temperature
- Cooler Off

Telecommand Packet Information (VIRTIS)			
Packet name	HTC_Cooler	Instrument	VIRTIS
Packet Function	Command the Cooler status		
Verification Rules	Change of state in Default H/K TM		
Header Information			
Process ID	51	Packet Category	12
Service Type	194	Service Subtype	5
Structure ID	N.A.	Packet Length	9
Data Field Information			
Data Field	Field Structure	Remarks	
Cooler Status	Enumerated Parameter 16 bits (PTC 2, PFC 16)	BIT 13..15: command Valid range: 1..4 1=Off 2=On Open Loop 3=On Close Loop 4= Stand-by (+28V on, motor drive off) BIT 0..12: always 0	
Temp/Speed	Unsigned Integer 16 bits (PTC 3, PFC 12)	BIT 4...15: Depending on Coolers Status: If 1=N.A. If 2=Cooler motor speed Valid range 1..3800 [rpm], 1...3800[bit] $a_R=1 \quad b_R=0$ If 3=(Temperature [K] - 60) * 102.375 with Temperature range 60...100 Valid range 60...100[Kelvin], 0..4095[bit] $a_R=102.375 \quad b_R=-6142$ If 4= NA BIT 0..12: always 0	
Notes:			
The $a_R$ and $b_R$ coefficients are referred to the following transfer function $TF: Y_{bit} = a_R * X + b_R$			
Acceptance Success/Failure Report can be required.			
Execution Success/Failure Report shall never be required.			

TC- 43: (PID51, PC12, T194, ST6) HTC\_Annealing

The following commands can be issued :

- Annealing Start
- Annealing Stop

Telecommand Packet Information (VIRTIS)			
Packet name	HTC_Annealing	Instrument	VIRTIS
Packet Function	Start/Stop Annealing on the IR detector		
Verification Rules	Change of state in Default H/K TM		
Header Information			
Process ID	51	Packet Category	12
Service Type	194	Service Subtype	6
Structure ID	N.A.	Packet Length	7
Data Field Information			
Data Field	Field Structure	Remarks	
Command	Enumerated Parameter 16 bits (PTC 2, PFC 16)	BIT 14..15: command Valid range: 1...2 1=Start 2=Stop BIT 0..13: always 0	
<b>Notes:</b>			
Annealing temperature limit is settable using HTC_Change_Func_Param_RAM or HTC_Change_Func_Param_RAM_EEPROM			
Acceptance Success/Failure Report can be required.			
Execution Success/Failure Report shall never be required.			

TC- 44: (PID51, PC12, T194, ST10) HTC\_Default\_Configuration

Telecommand Packet Information (VIRTIS)			
Packet name	HTC_Default_Configuration	Instrument	VIRTIS
Packet Function	Copy from EEPROM to RAM the Default Parameter Set		
Verification Rules	Memory Dump content in TM		
Header Information			
Process ID	51	Packet Category	12
Service Type	194	Service Subtype	10
Structure ID	N.A.	Packet Length	5
Data Field Information			
Data Field	Field Structure	Remarks	
<b>Notes:</b>			
No data field			
Acceptance Success/Failure Report can be required.			
Execution Success/Failure Report shall never be required.			

TC- 45: (PID51, PC12, T194, ST11) HTC\_Change\_Data\_Product\_Param\_RAM

The following command can be issued:

- Update the RAM copy of the data Production Parameter Set

Telecommand Packet Information (VIRTIS)			
Packet name	HTC_Change_Data_Product_Param_RAM	Instrument	VIRTIS
Packet Function	Update the RAM copy of the data Production Parameter Set		
Verification Rules	Event Report: H_Dump_Data_Production_Parameter		
Header Information			
Process ID	51	Packet Category	12
Service Type	194	Service Subtype	11
Structure ID	N.A.	Packet Length	7
Data Field Information			
Data Field	Field Structure	Remarks	
H_Data_Production_Mode	Enumerated parameter 16 bits (PTC 2, PFC 16)	BIT 14..15: Data Production Type: specifies the type of H session to be performed after the start given with the Enable Science Valid range=0,2,3,7,8,9 Default value=0 0 = H_Nominal_Observation 1 = DELETED 2 = H_Calibration 3 = H_Nominal_Simulation 4 = DELETED 5 = DELETED 6 = DELETED 7 = H_Spectral_Calibration_Simulation 8 = H_Science_Backup 9 = H_Test BIT 0..13: Always 0	
Notes:			
Acceptance Success/Failure Report can be required.			
Execution Success/Failure Report shall never be required.			



TC- 46: (PID51, PC12, T194, ST12) HTC\_Change\_Data\_Product\_Param\_RAM\_EEPROM

The following commands can be issued:

- Update the RAM copy of the data Production Parameter Set
- Update the EEPROM copy of the data Production Parameter Set

Telecommand Packet Information (VIRTIS)			
Packet name	HTC_Change_Data_Product_Param_RAM_EEPROM	Instrument	VIRTIS
Packet Function	Update the RAM and EEPROM copies of the data Production Parameter Set		
Verification Rules	Event Report		
Header Information			
Process ID	51	Packet Category	12
Service Type	194	Service Subtype	12
Structure ID	N.A.	Packet Length	7
Data Field Information			
Data Field	Field Structure	Remarks	
See TC- 45: (PID51, PC12, T194, ST11) HTC_Change_Data_Product_Param_RAM			
Notes:			
Acceptance Success/Failure Report can be required.			
Execution Success/Failure Report shall never be required			

TC- 47: (PID51, PC12, T194, ST13) HTC\_Change\_Func\_Param\_RAM

The following command can be issued:

- Update the RAM copy of the Functional Parameter Set

Telecommand Packet Information (VIRTIS)			
Packet name	HTC_Change_Func_Param_RAM	Instrument	VIRTIS
Packet Function	Update the RAM copy of the Functional Parameter Set		
Verification Rules	Event Report: H_Dump_Functional_Parameter		
Header Information			
Process ID	51	Packet Category	12
Service Type	194	Service Subtype	13
Structure ID	N.A.	Packet Length	55
Data Field Information			
Data Field	Field Structure	Remarks	
H_Int_Spect_T_Num1	Unsigned Integer 16 bits (PTC 3, PFC 12)	BIT 6..15 = LSB of integration time for Telescope Spectral Calibration $a_R=1953.125$ $b_R=-1024*INT$ MSW BIT 0..5 = always 0	
H_Int_Spect_T_Num2	Unsigned Integer 16 bits (PTC 3, PFC 12)	BIT 8..15 = MSB of integration time for Telescope Spectral Calibration $a_R=1.90735$ $b_R=0$ (to be considered only the integer part of the result) BIT 0..7 = always 0  Total Integration time: Valid range=512[us]...134.218[sec] Default value=0.5[sec], MSW 0[bit] LSW 977[bit]	
H_Int_Spect_S_Num1	Unsigned Integer 16 bits (PTC 3, PFC 12)	BIT 6..15 = LSB of integration time for Slit Spectral Calibration $a_R=1953.125$ $b_R=-1024*INT$ MSW BIT 0..5 = always 0	
H_Int_Spect_S_Num2	Unsigned Integer 16 bits (PTC 3, PFC 12)	BIT 8..15 = MSB of integration time for Slit Spectral Calibration $a_R=1.90735$ $b_R=0$ (to be considered only the integer part of the result) BIT 0..7 = always 0  Total Integration time: Valid range=512[us]...134.218[sec] Default value=6.14[ms], MSW 0[bit] LSW 12[bit]	
H_Int_Rad_Num1	Unsigned Integer 16 bits (PTC 3, PFC 12)	BIT 6..15 = LSB of integration time for Slit Spectral Calibration $a_R=1953.125$ $b_R=-1024*INT$ MSW BIT 0..5 = always 0	
H_Int_Rad_Num2	Unsigned Integer 16 bits (PTC 3, PFC 12)	BIT 8..15 = MSB of integration time for Slit Spectral Calibration $a_R=1.90735$ $b_R=0$ (to be considered only the integer part of the result) BIT 0..7 = always 0  Total Integration time: Valid range=512[us]...134.218[sec] Default value=0.5[sec], MSW 0[bit] LSW 977[bit]	

H_V_Bias	Unsigned Integer (PTC 3, PFC 12)	BIT 8..15 = Detector bias Valid range=0..3.722[volt],...0...255[bit] Default value=2.700[volt], 185[bit] $a_R=68.493$ $b_R=0.068$ unit: volt BIT 0..7 = always 0
H_I_Lamp_Spect_T	Unsigned Integer (PTC 3, PFC 12)	BIT 8..15 = Telescope Spectral Calibration lamp required current Valid range=0..23.1[mA], 0...255[bit] Default value=12.3[mA], 136[bit] $a_R=11.055$ $b_R=-0.055$ unit: mA BIT 0..7 = always 0
H_I_Lamp_Spect_S	Unsigned Integer (PTC 3, PFC 12)	BIT 8..15 = slit Spectral Calibration lamp required current Valid range=0..23.1[mA], 0...255[bit] Default value=12.3[mA], 136[bit] $a_R=11.055$ $b_R=-0.055$ unit: mA BIT 0..7 = always 0
H_I_Lamp_Radio	Unsigned Integer (PTC 3, PFC 12)	BIT 8..15 = radiometric Spectral Calibration lamp required current Valid range=0..23.1[mA], 0...255[bit] Default value=12.3[mA], 136[bit] $a_R=11.055$ $b_R=-0.055$ unit: mA BIT 0..7 = always 0
H_I_Shutter	Unsigned Integer (PTC 3, PFC 12)	BIT 8..15 = shutter required current Valid range=0..128.2[mA], 0...255[bit] Default value=55[mA], 110[bit] $a_R=1.9877$ $b_R=0$ unit: mA BIT 0..7 = always 0
H_Stab_Lamp_Time	Unsigned Integer (PTC 3, PFC 12)	BIT 8..15 = Time needed to stabilize the lamps Valid range=10..2000[ms], 1...200[bit] Default value=630[ms], 63[bit] $a_R=0.1$ $b_R=0$ BIT 0..7 = always 0
H_Stab_Det_Time	Unsigned Integer (PTC 3, PFC 12)	BIT 9..15 = Time needed to stabilize the detector Valid range=1..127[sec], 1...127[bit] Default value=10[sec], 10[bit] $a_R=1$ $b_R=0$ BIT 0..8 = always 0
H_Shutter_Time	Unsigned Integer (PTC 3, PFC 12)	BIT 12..15 = Time needed to stabilize the shutter for closing or opening Valid range=2..30[ms], 1...31[bit] Default value=20[ms], 10[bit] $a_R=0.5$ $b_R=0$ BIT 0..11 = always 0
H_Open_Cover_Step	Unsigned Integer 16 bits (PTC 3, PFC 12)	BIT 8..15 = Number of steps to do in one wave mode cover Valid range=1..255[step], 1...255[bit] Default value=60[step], 60[bit] $a_R=1$ $b_R=0$ BIT 0..7 = always 0
H_Spare	Unsigned Integer 16 bits (PTC 3, PFC 12)	
H_Close_Cover_Step	Unsigned Integer 16 bits (PTC 3, PFC 12)	BIT 8..15 = Number of steps to shut the Cover Valid range=1..255[step], 1...255[bit] Default value=120[step], 120[bit] $a_R=1$ $b_R=0$ BIT 0..7 = always 0

H_Init_Cover_Step	Unsigned Integer 16 bits (PTC 3, PFC 12)	BIT 8..15 = Number of steps to Initialize the Cover Valid range=1..255[step], 1...255[bit] Default value=16[step], 16[bit] $a_R=1$ $b_R=0$ BIT 0..7 = always 0
H_ECA_ACT	Unsigned Integer 16 bits (PTC 3, PFC 12)	BIT 8..15 = ECA actuation time Valid range=1..255[min], 1...255[bit] Default value=30[min], 30[bit] $a_R=1$ $b_R=0$ BIT 0..7 = always 0
H_Annealing_Check_Period	Unsigned Integer (PTC 3, PFC 12)	BIT 8..15 = Time between two temperature checks while annealing Valid range=1..255[sec], 1...255[bit] Default value=10[sec], 10[bit] $a_R=1$ $b_R=0$ BIT 0..7 = always 0
H_Annealing_Temp	Unsigned Integer 16 bits (PTC 3, PFC 12)	BIT 7..15 = Requested annealing temperature Valid range=293...353[Kelvin], 293...353[bit] Default value=303[Kelvin], 303bit $a_R=1$ $b_R=0$ BIT 0..6 = always 0
H_Annealing_Time	Unsigned Integer 16 bits (PTC 3, PFC 12)	BIT 8..15 = Duration of annealing Valid range=1..255[min], 1...255[bit] Default value=30[min], 30[bit] $a_R=1$ $b_R=0$ BIT 0..7 = always 0
H_Xwin	Unsigned Integer (PTC 3, PFC 12)	BIT 13..15 = X coordinate of the first pixel of the calibration window Valid range=0..6[pixel], 0...6[bit] Default value=3[pixel], 3[bit] $a_R=1$ $b_R=0$ BIT 0..12 = always 0
H_Ywin	Unsigned Integer (PTC 3, PFC 12)	BIT 12..15 = Y coordinate of the first pixel of the calibration window Valid range=0..14[pixel], 0...14[bit] Default value=7[pixel], 7[bit] $a_R=1$ $b_R=0$ BIT 0..11 = always 0
H_Test_Init	Unsigned Integer (PTC 3, PFC 12)	BIT 0..15 = First value of the test pattern

**Notes:**

 The  $a_R$  and  $b_R$  coefficients are referred to the following transfer function

$$TF: Y_{bit} = a_R * X + b_R$$

Acceptance Success/Failure Report can be required.

Execution Success/Failure Report shall never be required

TC- 48: (PID51, PC12, T194, ST14) HTC\_Change\_Func\_Param\_RAM\_EEPROM

The following command can be issued:

- Update the RAM copy of the Functional Parameter Set
- Update the EEPROM copy of the functional parameter sets

Telecommand Packet Information (VIRTIS)			
Packet name	HTC_Change_Func_Param_RAM_EEPROM	Instrument	VIRTIS
Packet Function	Update the RAM and EEPROM copies of the Functional Parameter Set		
Verification Rules	Event Report: H_Dump_Functional_Parameter		
Header Information			
Process ID	51	Packet Category	12
Service Type	194	Service Subtype	14
Structure ID	N.A.	Packet Length	55
Data Field Information			
Data Field	Field Structure	Remarks	
See TC- 47: (PID51, PC12, T194, ST13) HTC_Change_Func_Param_RAM			
Notes:			
Acceptance Success/Failure Report can be required.			
Execution Success/Failure Report shall never be required			

TC- 49: (PID51, PC12, T194, ST15) HTC\_Change\_Oper\_Param\_RAM

The following command can be issued:

- Update the RAM copy of the Operational Parameter Set

Telecommand Packet Information (VIRTIS)			
Packet name	HTC_Change_Oper_Param_RAM	Instrument	VIRTIS
Packet Function	Update the RAM copy of the Operational Parameter Set		
Verification Rules	Event Report: H_Dump_Operational_Parameter		
Header Information			
Process ID	51	Packet Category	12
Service Type	194	Service Subtype	15
Structure ID	N.A.	Packet Length	21
Data Field Information			
Data Field	Field Structure	Remarks	
H_Int_Science_Num1	Unsigned Integer (PTC 3, PFC 12)	BIT 6..15 = LSB of integration time for science mode $a_R=1953.125$ $b_R=-1024*INT$ MSW BIT 0..5 = always 0	
H_Int_Science_Num2	Unsigned Integer (PTC 3, PFC 12)	BIT 8..15 = MSB of integration time for science mode $a_R=1.90735$ $b_R=0$ (to be considered only the integer part of the result) BIT 0..7 = always 0  Total Integration time: Valid range=512[us]...134.218[sec] Default value=1[sec], MSW 1[bit] LSW 929[bit]	
H_SPARE	Unsigned Integer (PTC 3, PFC 12)		
H_Sum	Unsigned Integer (PTC 3, PFC 12)	BIT 8..15 = Flag indicating if the spectra have to be summed Valid range=0..1 Default value=0 0=no summing 1=summing BIT 0..7 = always 0	
H_N_Frame	Unsigned Integer (PTC 3, PFC 12)	BIT 5..15 = Repetition rate when no summing Valid range=1...2047[IRT], 1...2047[bit] Default value=1[IRT], 1[bit] $a_R=1$ $b_R=0$ BIT 0..4 = always 0	
H_N_Sum_Frame	Unsigned Integer (PTC 3, PFC 12)	BIT 8..15 = Number of successive summed frames when H_Sum is set Valid range=1...255[frame], 1...255[bit] Default value=10[frame], 10[bit] $a_R=1$ $b_R=0$ BIT 0..7 = always 0	
H_Dark_Rate	Unsigned Integer (PTC 3, PFC 12)	BIT 8..15 = Number of successive frames between 2 dark measurements Valid range=1...255[frame], 1...255[bit] Default value=10[frame], 10[bit] $a_R=1$ $b_R=0$ BIT 0..7 = always 0	

H_Comp	Enumerated parameter (PTC 2, PFC 16)	BIT 8..15 = Compression mode Valid range=0..4 Default value=1 0= No compression 1=Lossless, 2D 2=Wavelet_F1 2bits/datum 3=Wavelet_F2 1.5 bit/datum 4=Wavelet_F3 1 bit/datum summing BIT 0..7 = always 0
--------	---	---

**Notes:**

The  $a_R$  and  $b_R$  coefficients are referred to the following transfer function

$$TF: Y_{bit} = a_R * X + b_R$$

Acceptance Success/Failure Report can be required.

Execution Success/Failure Report shall never be required

**VIRTIS-H OPERATIVE PARAMETERS USED IN EACH OPERATIVE MODE**

	H_Data_Production_Mode	H_Int_Science	H_Win_Order	H_Sum	H_N_Frame	H_N_Sum_Frame	H_Dark_Rate	H_Comp
H_Science_Maximum_Data_Rate	0	x		x	x	x	x	x
H_Science_Nominal_Data_Rate	0	x		x	x	x	x	x
H_Science_Minimum_Data_Rate	0	x		x	x	x	x	x
DELETED	1							
H_Nominal_Simulation	3	x		x	x	x	x	x
H_Science_Backup	8	x		x	x	x	x	x
DELETED	4							
DELETED	6							
H_Calibration								
DELETED								
H_Spectral_Calibration_Simulation	7	x						0

TC- 50: (PID51, PC12, T194, ST16) HTC\_Change\_Oper\_Param\_RAM\_EEPROM

The following command can be issued:

- Update the RAM copy of the Operational Parameter Set
- Update the EEPROM copy of the Operational parameter Set

Telecommand Packet Information (VIRTIS)			
Packet name	HTC_Change_Oper_Param_RAM_EEPROM	Instrument	VIRTIS
Packet Function	Update the RAM and EEPROM copies of the Operational Parameter Set		
Verification Rules	Event Report: H_Dump_Operational_Parameter		
Header Information			
Process ID	51	Packet Category	12
Service Type	194	Service Subtype	16
Structure ID	N.A.	Packet Length	21
Data Field Information			
Data Field	Field Structure	Remarks	
<p>See <b>TC- 49: (PID51, PC12, T194, ST15) HTC_Change_Oper_Param_RAM</b></p>			
Notes:			
Acceptance Success/Failure Report can be required.			
Execution Success/Failure Report shall never be required			



TC- 51: (PID51, PC12, T194, ST21) HTC\_Change\_Pixel\_Map\_Param\_RAM

The following command can be issued:

- Update the RAM copy of the Pixel Map Parameter Set

Telecommand Packet Information (VIRTIS)			
Packet name	HTC_Change_Pixel_Map_Param_RAM	Instrument	VIRTIS
Packet Function	Update the RAM copy of the Pixel Map Parameter Set		
Verification Rules	Event Report: H_Dump_Pixel_Map_Parameter		
Header Information			
Process ID	51	Packet Category	12
Service Type	194	Service Subtype	21
Structure ID	N.A.	Packet Length	101
Data Field Information			
Data Field	Field Structure	Remarks	
H_Pix_Map_C11	Real (PTC 5, PFC 1)	Default value = 47.4995	
H_Pix_Map_C12	Real (PTC 5, PFC 1)	Default value = 0.124730	
H_Pix_Map_C13	Real (PTC 5, PFC 1)	Default value = 9.89069e-005	
H_Pix_Map_C21	Real (PTC 5, PFC 1)	Default value = 99.3860	
H_Pix_Map_C22	Real (PTC 5, PFC 1)	Default value = 0.0984494	
H_Pix_Map_C23	Real (PTC 5, PFC 1)	Default value = 7.08563e-005	
H_Pix_Map_C31	Real (PTC 5, PFC 1)	Default value = 134.168	
H_Pix_Map_C32	Real (PTC 5, PFC 1)	Default value = 0.0816675	
H_Pix_Map_C33	Real (PTC 5, PFC 1)	Default value = 4.91840e-005	
H_Pix_Map_C41	Real (PTC 5, PFC 1)	Default value = 159.186	
H_Pix_Map_C42	Real (PTC 5, PFC 1)	Default value = 0.0666196	
H_Pix_Map_C43	Real (PTC 5, PFC 1)	Default value = 4.09415e-005	
H_Pix_Map_C51	Real (PTC 5, PFC 1)	Default value = 177.340	
H_Pix_Map_C52	Real (PTC 5, PFC 1)	Default value = 0.0571319	
H_Pix_Map_C53	Real (PTC 5, PFC 1)	Default value = 2.70287e-005	
H_Pix_Map_C61	Real (PTC 5, PFC 1)	Default value = 190.468	
H_Pix_Map_C62	Real (PTC 5, PFC 1)	Default value = 0.0563404	
H_Pix_Map_C63	Real (PTC 5, PFC 1)	Default value = 5.26731e-006	
H_Pix_Map_C71	Real (PTC 5, PFC 1)	Default value = 201.200	
H_Pix_Map_C72	Real (PTC 5, PFC 1)	Default value = 0.0465433	
H_Pix_Map_C73	Real (PTC 5, PFC 1)	Default value = 1.06877e-005	
H_Pix_Map_C81	Real (PTC 5, PFC 1)	Default value = 209.314	
H_Pix_Map_C82	Real (PTC 5, PFC 1)	Default value = 0.0480639	
H_Pix_Map_C83	Real (PTC 5, PFC 1)	Default value = -8.72398e-006	
Notes:			
Each parameter is a real 32bit : BIT 9..31=Fraction, BIT 1..8=Exponent, BIT 0=Sign			
Associated Dead Pixel Map file : <b>DeadPXMap04-07-08.dat</b>			
The dead pixels that are within the pixel map are the following (counted from pixel (0,0) of a 438x270 image)			
- pxl 601 - pxl 864 - pxl 1081 - pxl 1706 - pxl 3263 - pxl 3319			
Acceptance Success/Failure Report can be required.			
Execution Success/Failure Report shall never be required			

TC- 52: (PID51, PC12, T194, ST21) HTC\_Change\_Pixel\_Map\_Param\_RAM\_EEPROM

The following command can be issued:

- Update the RAM copy of the Pixel Map Parameter Set
- Update the EEPROM copy of the Pixel Map Parameter Set.

Telecommand Packet Information (VIRTIS)			
Packet name	HTC_Change_Pixel_Map_Param_RAM_EEPROM	Instrument	VIRTIS
Packet Function	Update the RAM and EEPROM copies of the Pixel Map Parameter Set		
Verification Rules	Event Report: H_Dump_Pixel_Map_Parameter		
Header Information			
Process ID	51	Packet Category	12
Service Type	194	Service Subtype	21
Structure ID	N.A.	Packet Length	101
Data Field Information			
Data Field	Field Structure	Remarks	
See <b>TC- 51: (PID51, PC12, T194, ST21) HTC_Change_Pixel_Map_Param_RAM</b>			
Notes:			
Acceptance Success/Failure Report can be required.			
Execution Success/Failure Report shall never be required			

TC- 53: (PID51, PC12, T194, ST26) HTC\_Load\_Pixel\_Map

The following sequence can be issued:

- HS\_Load\_Pixel\_Map

Telecommand Packet Information (VIRTIS)			
Packet name	HTC_Load_Pixel_Map	Instrument	VIRTIS
Packet Function	Make the ME send the sequence HS_Load_Pixel_Map		
Verification Rules	The sequence includes the sequence: HS_Check_Pixel_Map		
Header Information			
Process ID	51	Packet Category	12
Service Type	194	Service Subtype	26
Structure ID	N.A.	Packet Length	5
Data Field Information			
Data Field	Field Structure	Remarks	
<b>Notes:</b>			
No data field			
Acceptance Success/Failure Report can be required.			
Execution Success/Failure Report shall never be required			

TC- 54: (PID51, PC12, T194, ST27) HTC\_Check\_Pixel\_Map

The following sequence can be issued:

- HS\_Check\_Pixel\_Map

Telecommand Packet Information (VIRTIS)			
Packet name	HTC_Check_Pixel_Map	Instrument	VIRTIS
Packet Function	Make the ME send the sequence HS_Check_Pixel_Map		
Verification Rules	Result of the check.		
Header Information			
Process ID	51	Packet Category	12
Service Type	194	Service Subtype	27
Structure ID	N.A.	Packet Length	5
Data Field Information			
Data Field	Field Structure	Remarks	
<b>Notes:</b>			
No data field			
Acceptance Success/Failure Report can be required.			
Execution Success/Failure Report shall never be required			

### 3.2.2.9 Service 255 – Common Payload Private TCs

This service provides general Payload commands.

TC- 55: (PID51, PC12, T255, ST1) Reset\_Telemetry\_Output\_Buffer

Telecommand Packet Information (VIRTIS)			
Packet name	Reset_Telemetry_Output_Buffer	Instrument	VIRTIS
Packet Function	Reset the Science Data Transfer output buffer, as part of DMS recovery procedure for TM errors		
Verification Rules			
Header Information			
Process ID	51	Packet Category	12
Service Type	255	Service Subtype	1
Structure ID	N.A.	Packet Length	5
Data Field Information			
Data Field	Field Structure	Remarks	
<b>Notes:</b>			
No data field			
Acceptance Success/Failure Report can be required.			
Execution Success/Failure Report shall never be required.			

TC- 56: (PID51, PC12, T255, ST2) Reset\_SMCS\_Chip

Telecommand Packet Information (VIRTIS)			
Packet name	Reset_SMCS_Chip	Instrument	VIRTIS
Packet Function	Reset the SCMS chip, as part of the DMS recovery procedure for HS link		
Verification Rules			
Header Information			
Process ID	51	Packet Category	12
Service Type	255	Service Subtype	2
Structure ID	N.A.	Packet Length	5
Data Field Information			
Data Field	Field Structure	Remarks	
<b>Notes:</b>			
No data field			
Acceptance Success/Failure Report can be required.			
Execution Success/Failure Report shall never be required.			

TC- 57: (PID51, PC12, T255, ST3) Start\_HS\_Link

Telecommand Packet Information (VIRTIS)			
Packet name	Start_HS_Link	Instrument	VIRTIS
Packet Function	Execute the HS link start procedure		
Verification Rules			
Header Information			
Process ID	51	Packet Category	12
Service Type	255	Service Subtype	3
Structure ID	N.A.	Packet Length	5
Data Field Information			
Data Field	Field Structure	Remarks	
<b>Notes:</b>			
No data field			
Acceptance Success/Failure Report can be required.			
Execution Success/Failure Report shall never be required.			

TC- 58: (PID51, PC12, T255, ST4) Reset\_And\_Start\_HS\_Link

Telecommand Packet Information (VIRTIS)			
Packet name	Reset_And_Start_HS_Link	Instrument	VIRTIS
Packet Function	Reset the SCMS chip and then execute the HS link start procedure		
Verification Rules			
Header Information			
Process ID	51	Packet Category	12
Service Type	255	Service Subtype	4
Structure ID	N.A.	Packet Length	5
Data Field Information			
Data Field	Field Structure	Remarks	
<b>Notes:</b>			
No data field			
Acceptance Success/Failure Report can be required.			
Execution Success/Failure Report shall never be required.			

#### 4 **DMS Resource Requirements**

##### 4.1 **SSMM Utilization**

SSMM utilisation is defined in Chapter 6.3.2.3 “Fly operations plans by mission phase” of the EID B document.

##### 4.2 **On-Board Control Procedures**

On board control procedures are defined in the document “VIRTIS experiment OBCP user requirement document”, Doc. N. RO-DSS-RS-1024.

##### 4.3 **On-board Monitoring Requirements**

No On-board monitoring requirement exists.

##### 4.4 **Information Distribution Requirements**

No Information Distribution requirement exists.

##### 4.5 **DMS TM Packetisation Requirements**

The sampling frequency for the thermistors to be acquired by the spacecraft on the OM Cold Box (2 main + 2 redundant S/C thermistors) is 0.1 Hz.