

ÇIVA / ROLIS IME

FM Acceptance Data Package

RO-LRS-ADP-3304 Issue 2 / Revision 1

Prepared by:

W. Bresch (IWP)
A. Chardin (IAS)
W. Fohrmann (IWP)
A. Lichopoj (IWP)
R. Schrödter (IWP)
A. Soufflot (IAS)
and other ROLIS and ÇIVA team members

Approved by:

.....
Dr. H. Michaelis (ROLIS & IME Project Manager)

.....
A. Soufflot (Co-Project Manager IME)

ROSETTA LANDER ÇIVA & ROLIS IME	Acceptance Data Package	
RO-LRS-ADP-3304	Issue 2.1	Model: FM

1 INTRODUCTION

This ADP contains the Rolis/Civa Imaging Main Electronics items. The RolisD camera items are described in a special RolisD ADP, [RO-LRS-ADP-3305], while the CIVA instrument items are outlined also in extra ADPs.

Starting with the version 2.0 the IME-ADP-FM is subdivided into the MAIN document and an ANNEX document. The document at hand is the Main document part. The second part of the IME-ADP-FM [RO-LRS-ADP-3304-A] contains the chapter 11 with all annexes belonging to the ADP.

1.1 DOCUMENT CHANGE RECORD

Issue / Revision	Date	Reason for change	Sections affected
1.0	12/04/01	New document	all
1.1	29/05/01	Added documents	
1.2	9/08/2001	document update	Section 5, especially revised List of Rolis-Tcmd and Table of HK; Sections 3.1, 3.2, 3.3, 3.4 updated; Section 4.4.1 – Tab.4.4.1-2 revised; Additional documents included in chapter 11 (annex)
1.3	8/10/01	document update	Section 5, especially dedicated Civa issues
1.4	11/01/02	document update	Section 5, especially revised List of Rolis-Tcmd and Table of HK; 2.3.2 Functional Diagram of RolisIME; Table 2.4.1-1;
	15/05/02	New Tcmd	Revision of List of Rolis-Tcmd; Annex – section 11 revised
1.5	28/08/02	New Tcmd	Revision of List of Rolis-Tcmd and Table of HK after S-D-L Test on Lander level at ESTEC in Noordwijk
2.0	10-Mar-06	document update	Sections 5 and 8 from GRM-ADP 1.2 included; Document structure changed: ADP subdivided into the MAIN document and an ANNEX document
2.1	11-Oct-16	Typographical and layout corrections	Throughout the document

ROSETTA LANDER ÇIVA & ROLIS IME	Acceptance Data Package
RO-LRS-ADP-3304	Issue 2.1
	Model: FM

1.2 LIST OF ACRONYMS

A/D	Analog to digital converted (values)
ADC	analog to digital converter
ADP	Acceptance Data Package
ADJ	Adjustment devices (ROLIS 1-12)
AIT	Assembly, integration and test
AIV	Assembly, integration and verification
ASCII	American Standard Code for Information Interchange
ATL	ATtachment Leg(s) (ROLIS 1-13)
BOL	Begin of life
BP	Common BackPlane (IME2-04)
CAB	Cable W215, connecting IME (CEB) with ROLIS CH (ROLIS 1- 15)
CAM	CH housing (ROLIS 1-01)
CDMS	Central Data Management System (Rosetta Lander)
CE	ÇIVA Central Electronics
CEB	Common Electronic Box of the Rosetta Lander
CEB-Z	Z-Common Electronic Box, containing the IME
CH	Camera Head
CI	Configuration item
CIDL	Configuration Item Data List
ÇIVA	Imaging Experiment on the Rosetta Lander (IAS, France)
COBT	Coded on-board time
ComDPU	Common (ROLIS-) DPU
ComGND	Common ground of IME
CON	external ROLIS-D connector (ROLIS 1-06)
CoG	Center of Gravity
COV	Protection Cover for CH (ROLIS 1-16)
CP	Cover plate (Connector plate)
CUC	ROLIS Close-up colour imaging (mode)
CUS	ROLIS Close-up stereo imaging (mode)
CWC	Common working circle (of Lander)
DC	Direct Current
DEBx	ComDPU debug monitor commands
DEPL	Declared EEE-Parts List
DIS	ROLIS Descent imaging with instrument internal data storage (mode)
DIT	ROLIS Descent imaging with instant data transmission (mode)
DLR	Deutsches Zentrum für Luft- und Raumfahrt (German Aerospace Center)
DML	Declared Materials List
DMPL	Declared Mechanical Parts List
DPL	Declared Processes List
DPU	Data Processing Unit
DPU/C	ÇIVA-DPU basic board
DPU/P	ÇIVA-DPU extension board
DRV	IFL drive (ROLIS 1-08)
DUT	Device Under Test
ECP	Engineering Change Proposal
ECDR	Experiment Conceptual Design Review
EEE	Electrical Electronical Electromechanical (parts)
EEPROM	Electrically erasable programmable read-only memory
EFDR	Experiment Final Design Review
EGSE	Electrical Ground Support Equipment
EID	Experiment Interface Document
EM	Engineering Model
EMC	Electro-Magnetic Compatibility

ROSETTA LANDER ÇIVA & ROLIS IME	Acceptance Data Package	
RO-LRS-ADP-3304	Issue 2.1	Model: FM

FT	Functional Test
EOL	End of life
EQM	Electrical Qualification Model
ESA SCC	ESA space components coordination (specifications)
ESS	Electrical support system
EXM	Excenter mechanism (ROLIS 1-09)
FEM	Finite Element Model
FM	Flight Model
FMECA	Failure Modes and Effects Critical Analysis
FOV	Field Of View
FPA	Focal Plane Assembly
FS	Flight Spare (model)
GND	Grounding bolt (ROLIS 1-07)
HK	Housekeeping (data)
HSIA	Hardware software interaction analysis
H/W	Hardware
IC	Individually controlled (unit)
ID	Illumination Device of ROLIS-D
IAS	Institut d'Astrophysique Spatiale (Orsay, France)
ID	Illumination device (ROLIS 1-11)
I/F	Interface
IFL	Infinity front lens (ROLIS 1-03)
IM	infinity mode of ROLIS optics
IME	(ROLIS & CIVA) Imaging Main Electronics
IME1c	IME and ROLIS power conditioning (piggy back) board
IR	Infra-red
ISB	ROLIS Imaging Status Block
IWP	DLR Institute of Space Sensor Technology & Planetary Exploration (Berlin, Germany)
KIP	Key inspection point
LCL	inductivity-capacity-inductivity (filter)
LED	Light Emitting Diode
LLS	Low Level Sweep
LN ₂	Liquid Nitrogen (N ₂)
LPC	Lander Low Power Converter
LT	Lander Team
MEM	Main Electronics Memory (Mass MEMory board of RolisIME)
MICE	MOSES interface control electronics (ROLIS 1-05)
MIP	Mandatory inspection point
MLI	Multi-Layer Insulation
MoI	Momentum of Inertia
MOSES	Modular Sensor Electronics System (ROLIS 1-04)
MSS	Mechanical support system
MUX	MULTipleXer
N/A	Not Applicable
N/C	Not Connected
NCR	Non conformance report
OBT	On-Board Time
PM	Pre-Flight Model
PIF	Plug-in Frame IME (IME 2-00)
PSS	Power Subsystem (Lander Power System)
QA	Quality assurance
RfD	Request for Deviation
SFL	Surface Front Lens
SFOV	Scientific field-of-view (FOV covered by detector)
REID	Rosetta Lander Experiment Interface Document
RfW	Request for Waiver
ROLIS	ROsetta Lander Imaging System

ROSETTA LANDER		Acceptance Data Package	
ÇIVA & ROLIS IME			
RO-LRS-ADP-3304		Issue 2.1	Model: FM

ROLIS-D	ROLIS camera (head)
RolisD	ROLIS camera (head)
ROLIS-DPU	ComDPU for ROLIS
RolisDPU	ComDPU for ROLIS
RolisIME	ROLIS-part of the Imaging Main Electronics
SFT	Short (Simplified) Functional Test
SMO	Surface Mode Optics (ROLIS 1-02)
SPF	Single Point Failure
SSADR	Subsystem Address Word
SSP	Surface Science Package (Rosetta Lander)
S/W	Software
STM	Structural and Thermal Model
TBA	To be added
TBC	To Be Confirmed
TBD	To Be Defined
TBM	To Be Measured
TC	(Volume of) telecommands
Tcmd	telecommand
TN	Technical Note
TM	(Volume of) telemetry data
TMM	Thermal Mathematical Model
TRP	Thermal Reference Point
TS	Temperature sensor
TV	Thermal Vacuum (test)
TVC	Thermal Vacuum Chamber
UFOV	Unobstructed Field-Of-View
URF	Unit Reference Frame
VCD	Verification Control Document
WRDC	WoRD Count field

ROSETTA LANDER ÇIVA & ROLIS IME	Acceptance Data Package	
RO-LRS-ADP-3304	Issue 2.1	Model: FM

1.3 TABLE OF CONTENTS

1	INTRODUCTION	2
1.1	DOCUMENT CHANGE RECORD	2
1.2	LIST OF ACRONYMS	3
1.3	TABLE OF CONTENTS	6
1.4	LIST OF DELIVERY ITEMS.....	9
1.5	LIST OF SPARES, STATUS OF SPARES	11
1.6	PSR MoM TBC	11
1.7	LIST OF OPEN ACTIVITIES	12
2	MAIN CHARACTERISTICS	12
2.1	SUBSYSTEM SPECIFICATION / REID-B	12
2.2	GENERAL BLOCK DIAGRAM OF THE ROLIS AND ÇIVA INSTRUMENTS.....	14
2.3	FUNCTIONAL DIAGRAMS	15
2.3.1	<i>Functional Diagram of CivaIME</i>	<i>15</i>
2.3.2	<i>Functional Diagram of RolisIME</i>	<i>16</i>
2.4	BUDGET DATA	17
2.4.1	<i>Power Budget.....</i>	<i>17</i>
2.4.2	<i>Mass Budget.....</i>	<i>19</i>
2.4.3	<i>Memory Budget.....</i>	<i>19</i>
3	MECHANICAL AND THERMAL DATA.....	19
3.1	MECHANICAL INTERFACE AND OVERVIEW DRAWINGS	19
3.2	ALIGNMENT REQUIREMENTS.....	21
3.3	THERMAL BUDGET DATA	21
3.4	THERMAL INTERFACE CONTROLLED DRAWING	21
4	ELECTRICAL DATA.....	22
4.1	ELECTRICAL INTERFACE AND OVERVIEW DRAWINGS	22
4.2	ELECTRICAL DETAILS SCHEMATICS	22
4.3	GROUNDING DIAGRAM.....	22
4.4	PIN ALLOCATION TABLE.....	23
4.4.1	<i>IME internal harness.....</i>	<i>23</i>
4.4.2	<i>ÇIVA interface connectors</i>	<i>26</i>
4.4.3	<i>RolisD interface connector.....</i>	<i>28</i>
5	SOFTWARE	29
5.1	GENERAL REMARKS.....	29
5.1.1	<i>Common-DPU vs. ROLIS-DPU</i>	<i>29</i>
5.1.2	<i>ROLIS software configuration</i>	<i>29</i>
5.2	FLOW CHART	29
5.2.1	<i>CDMS: message interpreter.....</i>	<i>32</i>
5.2.2	<i>FRAME: Science data output.....</i>	<i>32</i>
5.2.3	<i>ÇIVA: ROLIS/ÇIVA interface.....</i>	<i>32</i>
5.2.4	<i>ROLIS: Camera head control + image processing</i>	<i>32</i>
5.3	MEMORY ALLOCATION TABLE OF ROLIS-IME	33
5.4	ROLIS / ÇIVA TELECOMMANDS	33
5.4.1	<i>Telecommand verification.....</i>	<i>33</i>
5.4.2	<i>Telecommand classification</i>	<i>34</i>
5.4.3	<i>ROLIS “immediate” telecommands, order of execution</i>	<i>34</i>
5.4.4	<i>ROLIS: ComDPU debug monitor telecommands.....</i>	<i>35</i>
5.4.5	<i>ÇIVA telecommands</i>	<i>37</i>
5.4.6	<i>ROLIS telecommands.....</i>	<i>45</i>
5.5	LIST OF TELEMETRY PACKETS (SCIENCE AND H/K).....	54

ROSETTA LANDER ÇIVA & ROLIS IME	Acceptance Data Package	
RO-LRS-ADP-3304	Issue 2.1	Model: FM

5.5.1	<i>ROLIS / ÇIVA housekeeping data (HK) - overview</i>	54
5.5.2	<i>Description of ROLIS / ÇIVA housekeeping data</i>	55
5.5.3	<i>ComDPU messages (science data)</i>	58
5.5.4	<i>ROLIS / ÇIVA science data frames</i>	59
5.5.5	<i>ROLIS science data frames classification</i>	60
5.5.6	<i>ROLIS image compression</i>	65
5.5.7	<i>ÇIVA telemetry</i>	67
5.5.8	<i>ÇIVA image compression</i>	79
5.6	LIST OF IMPLEMENTED CDMS ACTION CODES AND REQUEST CODES	81
5.6.1	<i>CDMS action codes (Table 5.6.1)</i>	81
5.6.2	<i>CDMS Service Request Codes (Table 5.6.2)</i>	81
5.7	CALIBRATION DATA	82
6	UNIT LEVEL VERIFICATION	82
6.1	TEST MATRIX	82
6.2	INSPECTION REPORTS	83
6.3	QUALIFICATION TEST REPORTS	83
6.4	ACCEPTANCE TEST REPORTS	85
6.5	CERTIFICATES	85
6.6	CLOSE-OUT PHOTOS	86
7	TEST DEFINITION	91
7.1	BENCH TEST PROCEDURE	91
7.2	LIMITED FUNCTIONAL TEST DEFINITION	91
7.3	FULL FUNCTIONAL TEST DEFINITION	91
7.4	SPECIAL FUNCTIONAL TEST DEFINITION	91
8	OPERATION	92
8.1	HANDLING, TRANSPORT, STORAGE, AND INSTALLATION PROCEDURE	92
8.1.1	<i>Handling, transport and storage</i>	92
8.1.2	<i>Installation procedure</i>	92
8.1.3	<i>Disintegration procedure</i>	94
8.2	OPERATIONAL CONSTRAINTS AND INSTRUCTIONS FOR OPERATING	94
8.2.1	<i>General Operational constraints</i>	94
8.2.2	<i>Operational constraints of the power switch commands</i>	94
8.2.3	<i>ROLIS Tcmd “Config” and the various diagnostic levels</i>	95
8.2.4	<i>ROLIS during touch-down</i>	96
8.2.5	<i>ROLIS Tcmd “WaitDataComplete”</i>	96
8.2.6	<i>ROLIS S/W upload and verification procedure</i>	96
8.2.7	<i>ÇIVA S/W upload and verification procedures</i>	97
8.2.8	<i>HK interpretation according timeline</i>	98
8.2.9	<i>Timing details of measuring of the 16 Rolis/CivaHW-HK values</i>	98
8.2.10	<i>Rolis / Civa text frames in the data stream</i>	99
8.2.11	<i>ROLIS image data and ISB</i>	99
8.3	GSE SPECIFICATION	100
8.3.1	<i>Bench Test Configuration</i>	100
8.3.2	<i>EGSE Functionality and Integrated IME Tests</i>	100
8.3.3	<i>Bench test set-up</i>	101
8.3.4	<i>GSE computer set-up</i>	101
8.4	MAINTENANCE HANDBOOK	102
8.5	LOGBOOK/HISTORICAL RECORD CARD	102
8.6	MATING/DEMATING LOG	102
9	PRODUCT ASSURANCE DATA	102
9.1	DECLARED MATERIALS LIST	102
9.2	DECLARED MECHANICAL PARTS LIST	102
9.3	DECLARED PROCESSES LIST	102

ROSETTA LANDER ÇIVA & ROLIS IME	Acceptance Data Package	
RO-LRS-ADP-3304	Issue 2.1	Model: FM

9.4	DECLARED EEE-PARTS LIST.....	102
9.5	EEE-PARTS APPLICATION LIST	102
9.6	SAFETY DATA	103
9.7	CLEANLINESS CERTIFICATE	103
10	CONFIGURATION CONTROL	104
10.1	CONFIGURATION ITEMS DATA LIST / CIDL	104
10.2	LIST OF NON CONFORMANCE REPORTS (NCR)	104
10.3	LIST OF WAIVER AND ECR REQUESTS.....	105

ROSETTA LANDER ÇIVA & ROLIS IME	Acceptance Data Package	
RO-LRS-ADP-3304	Issue 2.1	Model: FM

1.4 LIST OF DELIVERY ITEMS

The following tables list all delivered items separately for the ÇIVA / ROLIS IME (table 1.4-1). Moreover, tables 1.4-2 and 1.4-3 give overviews of all components which have been integrated into the PIF and the ÇivaDPU subunits delivered.

Table 1.4-1 : Items delivered with the ÇIVA / ROLIS IME (IME 2F)

Part. No. (Subunit)	Items	Description	Remarks and CIVA part numbers
ROLIS 2- 01F-2 (RolisDPU)	1	IME Board in slot#3: ROLIS Data Processing Unit	
ROLIS 2- 02F-1 (MEM)	1	IME Board in slot#2: Data Memory board	
IME 2- 00F-1 (PIF)	1	Plug-in Frame IME (for subcomponents see table 1.4-2)	
OT32 (ÇivaDPU)	1	IME boards in slot#5: ÇIVA Central Electronics / Data Processing Unit (for subcomponents see table 1.4-3)	
OT31 (ÇivaMID)	1	IME board in slot#4: ÇIVA-IR Microscope electronics	403 589 / 02
ROLIS-2-10F-1 (RolisSW)	1	ROLIS On-Board-S/W (EEPROM – resident)	Rolis-FM/2010 8.5.2001 16:26 (at shipment) For currently used version cf. Annex 16.6 RolisSW-LogBook

For relevant figures see ÇIVA / ROLIS IME close-out photos (cf. Sect. 6.6).

Table 1.4-2: Subunits integrated into PIF (Part. No. IME 2-00F-1; cf. table 1.4-1)

Part. No. (Subunit)	Items	Description	Remarks and CIVA part numbers
IME 2-04F-2 OT33 (BP)	1	Common Backplane for ÇIVA / ROLIS IME boards	404 398 / 05
IME 2-05F-2 OT34 (CP)	1	Cover Plate	34D0218
OT344	1	Angle bracket for ÇIVA-DPU connector, mounted in the CP	34B0171
IME 2- 03F-2 (IME1c)	1	IME 1c board: additional piggy back board on ExpIF	
IME 2- 07F-2 (ExpIF)	1	Experiment interface consisting of a main board (1a) and a piggy back board (1b)	
IME 2- 58F-2 (MF)	1	Mounting frame (angle bracket) for ExpIF	
IME 2- 59F-2 (J159)	1	31-pins connector for CAB W215, mounted in the CP	(0P9)
IME 2- 59-01F-2 (SAV)	1	Connector saver for J159	(red-tag item)

Part. No. (Subunit)	Items	Description	Remarks and ÇIVA part numbers
IME 2-27F-2 (J162)	1	21-pins ÇIVA connector for CAB W222, mounted in the CP	(0S7) For ÇIVA-P/S
IME 2-28F-2 (J158)	1	21-pins ÇIVA connector for CAB W213, mounted in the CP	(0S8) For ÇIVA-M/V
IME 2-30F-2 (J160)	1	25-pins ÇIVA connector for CAB W214, mounted in the CP	(0S10) For ÇIVA-M/I
IME 2-31F-2 (J161)	1	15-pins ÇIVA connector for CAB W140, mounted in the CP	(0S11) For ÇIVA-M/I
IME 2-33F-2 (J157)	1	9-pins ÇIVA connector for CAB W159, mounted in the CP	For heater's power lines
IME 2-37F-2 (J163)	1	31-pins ÇIVA connector for CAB W223, mounted in the CP	(0S17) For ÇIVA-P/S
IME 2-34F-2 (J164)	1	9-pins ÇIVA connector for CAB W26, mounted in the CP	(0S13) For ÇIVA-M/V
(SAV)	1	Connector saver for J157	(red-tag item)
(SAV)	1	Connector saver for J158	(red-tag item)
(SAV)	1	Connector saver for J160	(red-tag item)
(SAV)	1	Connector saver for J161	(red-tag item)
(SAV)	1	Connector saver for J162	(red-tag item)
(SAV)	1	Connector saver for J163	(red-tag item)
(SAV)	1	Connector saver for J164	(red-tag item)
IME 2-51F-2 OT341 (PIL)	2	Supporting pillars, connecting the ROLIS-part of BP and CP	34A0174
OT342 (PIL)	1	Supporting tore, connecting the ROLIS-part of BP and CP	34A0292
IME 2-61F-X OT341 (PIL)	4	Supporting pillars, connecting the ÇIVA -part of BP and CP	34A0174
IME 2-52F-2 (CLH)	1	Clamping holder for IME1c	
IME 2-53-01F-2 OT343 (COH)	1	Connector holder for J159 connector	34A0312
IME 2-53-02F-2 OT343 (COH)	1	Connector holder for J163 connector	34A0312
IME 2-53-03F-2 OT343 (COH)	1	Connector holder for J160 connector	34A0312
IME 2-53-04F-2 OT343 (COH)	1	Connector holder for J162 connector	34A0312
IME 2-53-05F-2 OT343 (COH)	1	Connector holder for J158 connector	34A0312
IME 2-53-06F-2 OT343 (COH)	1	Connector holder for J161 connector	34A0312

ROSETTA LANDER ÇIVA & ROLIS IME	Acceptance Data Package
RO-LRS-ADP-3304	Issue 2.1 Model: FM

Part. No. (Subunit)	Items	Description	Remarks and CIVA part numbers
IME 2-53-07F-2 OT343 (COH)	1	Connector holder for J164 connector	34A0312
IME 2-53-08F-2 OT343 (COH)	1	Connector holder for J157 connector	34A0312
IME 2-54-01F-2 IME 2-54-02F-2 IME 2-54-03F-2 IME 2-54-04F-2 IME 2-54-05F-2 (DIE)	5	Distance elements for IME1c	
IME 2-61F-1 (TOR)	1	Tore (coil) in the secondary power lines of C+18.5V, C+15V, C+12V, R+5V, A+5V, C+5V, A-5V, C-5V and C-12V.	

For standard components (screws, etc.) see the ÇIVA / ROLIS IME Materials and Mechanical Parts List (see **Annex 2**).

Table 1.4-3: Subunits integrated into the ÇIVA-DPU (Part. No. ÇIVA 2-08F-1; cf. table 1.4-1)

Part. No. (Subunit)	Items	Description	Remarks and CIVA part numbers
OT321 (ÇivaDPU/C)	1	IME boards connected to slot#5a: ÇIVA Central electronics board	404 390 / 04
OT322 (ÇivaDPU/P)	1	IME boards connected to slot#5b: ÇIVA Peripheric electronics board	404 397 / 04
OT3214	1	ÇIVA cube supporting frame	34C0295
OT3233 (DIV)	4	Distance elements for ÇIVA-DPU/P board	34A0228
OT3232	2	ÇIVA-DPU/C holding support	34A0173
OT3231	2	ÇIVA cube supporting frame holding support	34A0313

1.5 LIST OF SPARES, STATUS OF SPARES

One complete FSM is prepared. It will be used in case of trouble encountered with the FM.

1.6 PSR MOM TBC

See PSR MOM ÇIVA/ROLIS IME 11/04/2001 by G. Nietner in **Annex 15**.

See also the MOM of the relevant Progress Meeting that took place 17/05/01, included in **Annex 15**.

ROSETTA LANDER ÇIVA & ROLIS IME	Acceptance Data Package	
RO-LRS-ADP-3304	Issue 2.1	Model: FM

1.7 LIST OF OPEN ACTIVITIES

No open activities regarding the delivery of the ROLIS / CIVA IME.

2 MAIN CHARACTERISTICS

2.1 SUBSYSTEM SPECIFICATION / REID-B

ROLIS and ÇIVA are two experiments on the Rosetta SSP (Lander) with a common electrical interface to the SSP. The ROLIS and ÇIVA instrument heads / camera heads are controlled by a common Imaging Main Electronics (IME) located inside of the Common Electronic Box (CEB-Z). The IME includes the common electrical interface to Lander power subsystem (PSS) and Central Data Management System (CDMS).

The block scheme ROLIS / ÇIVA / IME (cf. Section 2.2) shows the structure of the ROLIS and ÇIVA experiments, including the IME in general.

The ROLIS & ÇIVA IME is located inside the CEB-Z which houses the electronics of different instruments of the Rosetta SSP. The IME is from the mechanical point of view a frame to plug into the CEB. The front of this frame is outlined in form of the Cover Plate (CP), in which the connectors for the camera harness are mounted. The connector of the frame to the CEB mother board is located vice versa on the rear side of the IME (-x direction). The IME BackPlane (BP) containing the slots for 4 electronic boards (slot #2 – #5) is mounted to the CP by 8 supporting pillars (PIL).

The IME is based on a two-processor concept, consisting of the RolisDPU (processor RTX 2010) and the ÇIVA-CE (ADSP 21020).

The power lines are linked to the camera heads and switched on / off by specific commands of the ROLIS-DPU or ÇIVA-DPU respectively. The different IME modules / boards are electrically connected by a backplane (BP), while the camera heads are connected to the IME via cables ending at connectors on the cover plate (CP) of IME, which are finally also connected to the BP.

The IME receives commands (from the CDMS) and power (from the PSS) via the Experiment Interface Board (ExpIF). The power on switches on automatically the ROLIS-part of the IME (RolisIME), especially the RolisDPU. In a next step the CivaDPU, CIVA-Heaters or the RolisD CH can switched on by dedicated ROLIS-telecommands (cf. Table 5.4.6). Further CDMS commands regarding CIVA will be transferred by RolisIME to the ÇIVA-DPU, which controls the ÇIVA camera heads and processes the ÇIVA raw data. The IME transfers also the ready-to-telemetry ROLIS and ÇIVA data via the ‘Lander I/F’ to the CDMS.

The RolisDPU is based on the low power, radiation hard processor RTX2010, packaged in standard 2D technology. It will activate the CHs by switching on the power, and send control commands according to the commands received from the CDMS. The RolisIME is connected to the ROLIS camera via high-speed serial links. It performs the data buffering in the MEM and the on-board data processing.

To cope with the data volume accumulating during a fast imaging session a data buffer of about 16MB, corresponding to about 8 uncompressed (raw) images, is foreseen, which also buffers the images compressed off-line before being transferred to CDMS.

The ÇIVA Central Electronics (ÇIVA-CE) consists of 2 boards (mother- and daughter board): ÇivaDPU/C and ÇivaDPU/P. The ÇIVA-part of IME contains beside the both ÇivaDPU boards the ÇIVA-Microscope electronics (ÇIVA-MID board).

ROSETTA LANDER ÇIVA & ROLIS IME	Acceptance Data Package	
RO-LRS-ADP-3304	Issue 2.1	Model: FM

The Experiment Interface Board is contributed by the Lander Team. It interfaces the IME to the CDMS and to the power system of the Rosetta SSP. The ExpIF consists of the basic board 1a and its daughter board 1b (Power Switch-on Board). A further daughter board 1c (IME-1c Board) contains the power switching for the RolisD CH and the +15V power conditioning for ÇIVA and ROLIS. All three boards together are connected to the back plane via cables (slot #1).

In summary the IME contains the following parallel main boards in the 5 slots:

Slot #1	ExpIF IME1c	Experiment I/F board (1a-board + 1b-board) IME1c Board (1c-board)
Slot #2	MEM	Data Memory board, containing ROLIS-CH I/F
Slot #3	RolisDPU	ROLIS Data Processing Unit, containing the DPU/DPU-I/F to ÇIVA
Slot #4	ÇIVA-MID	ÇIVA-Microscope Electronics board
Slot #5	Çiva-DPU/C Çiva-DPU/P	ÇIVA Data Processing Unit (2 boards)

The RolisIME fulfils the following common tasks for the ROLIS- and ÇIVA-experiment:

- CDMS command interface,
- Storage of processed data in the main electronics memory (MEM),
- Transfer of imaging and housekeeping data to the CDMS.

Additionally the ROLIS-DPU fulfils the following ROLIS specific tasks:

- Data acquisition from the ROLIS camera via high-speed serial links,
- Buffering of the ROLIS imaging raw data,
- Data processing of ROLIS data (image compression).

The ROLIS-DPU cooperates with the ÇIVA-CE via a medium speed link.

The detailed subsystem specification is included in the “ÇIVA EID-B” (**Annex 5** § 11.5) and the “ROLIS & IME REID-B” (**Annex 6** §11.6).

2.2 GENERAL BLOCK DIAGRAM OF THE ROLIS AND ÇIVA INSTRUMENTS

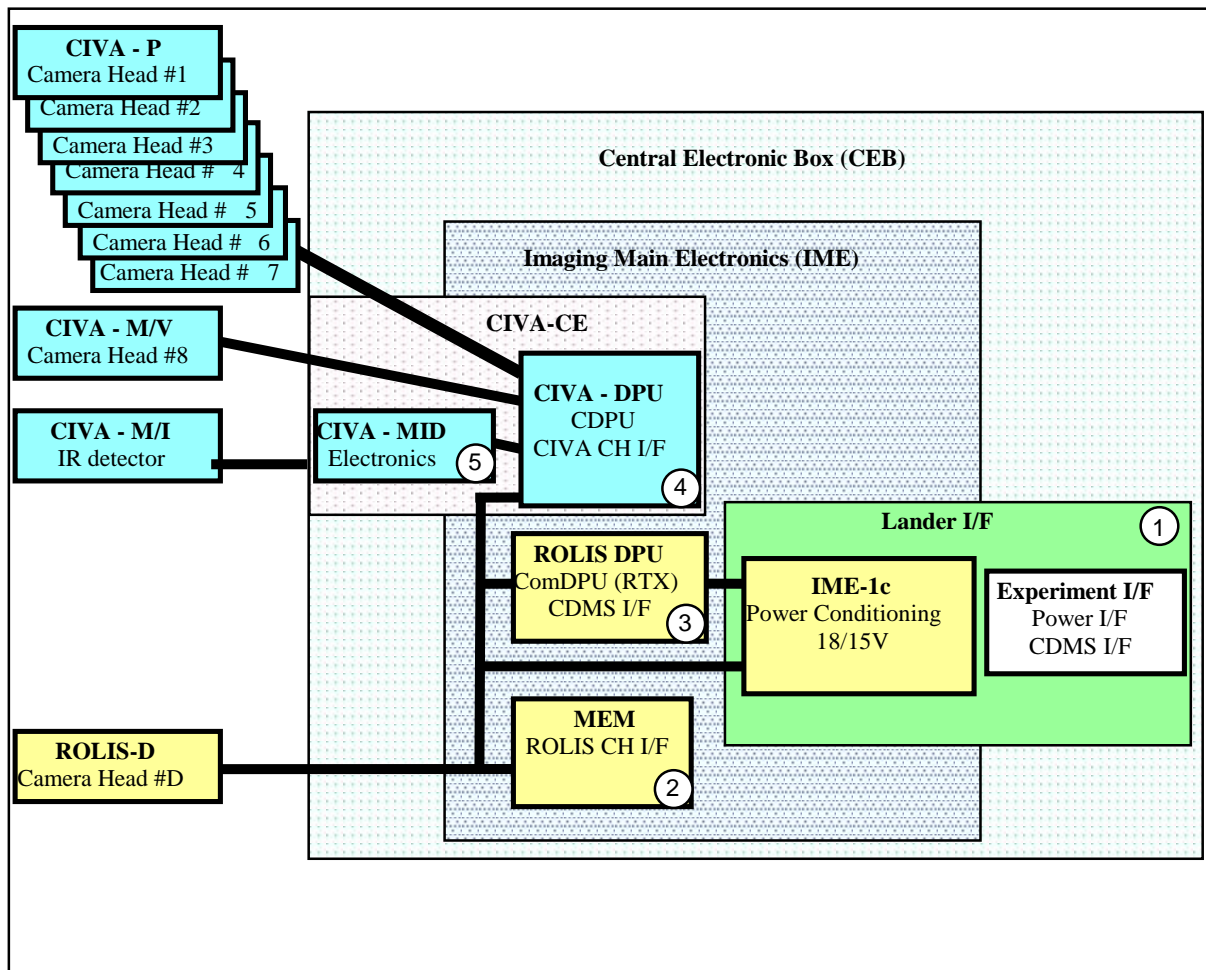

2.3 FUNCTIONAL DIAGRAMS

2.3.1 Functional Diagram of CivaIME

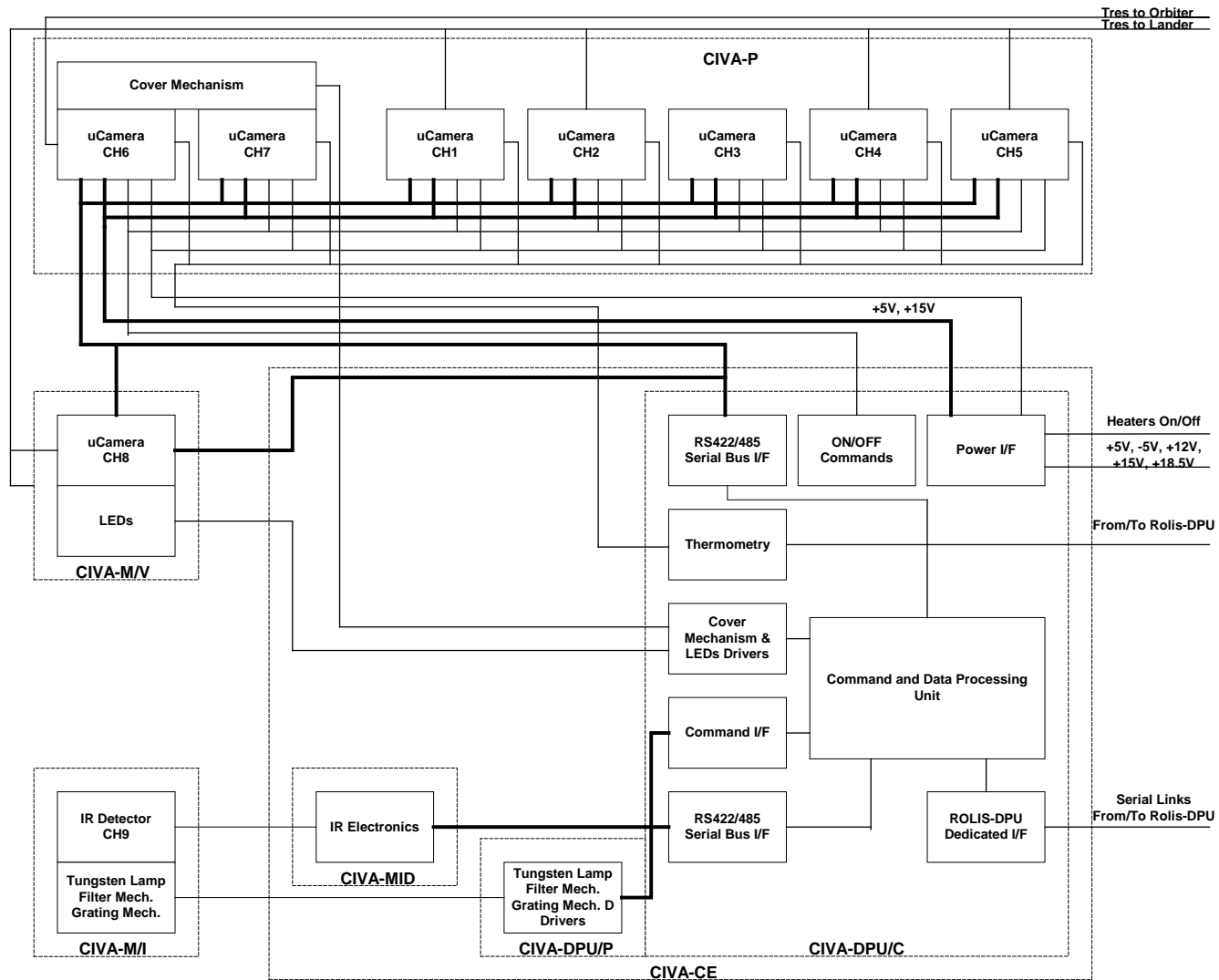

2.3.2 Functional Diagram of RolisIME

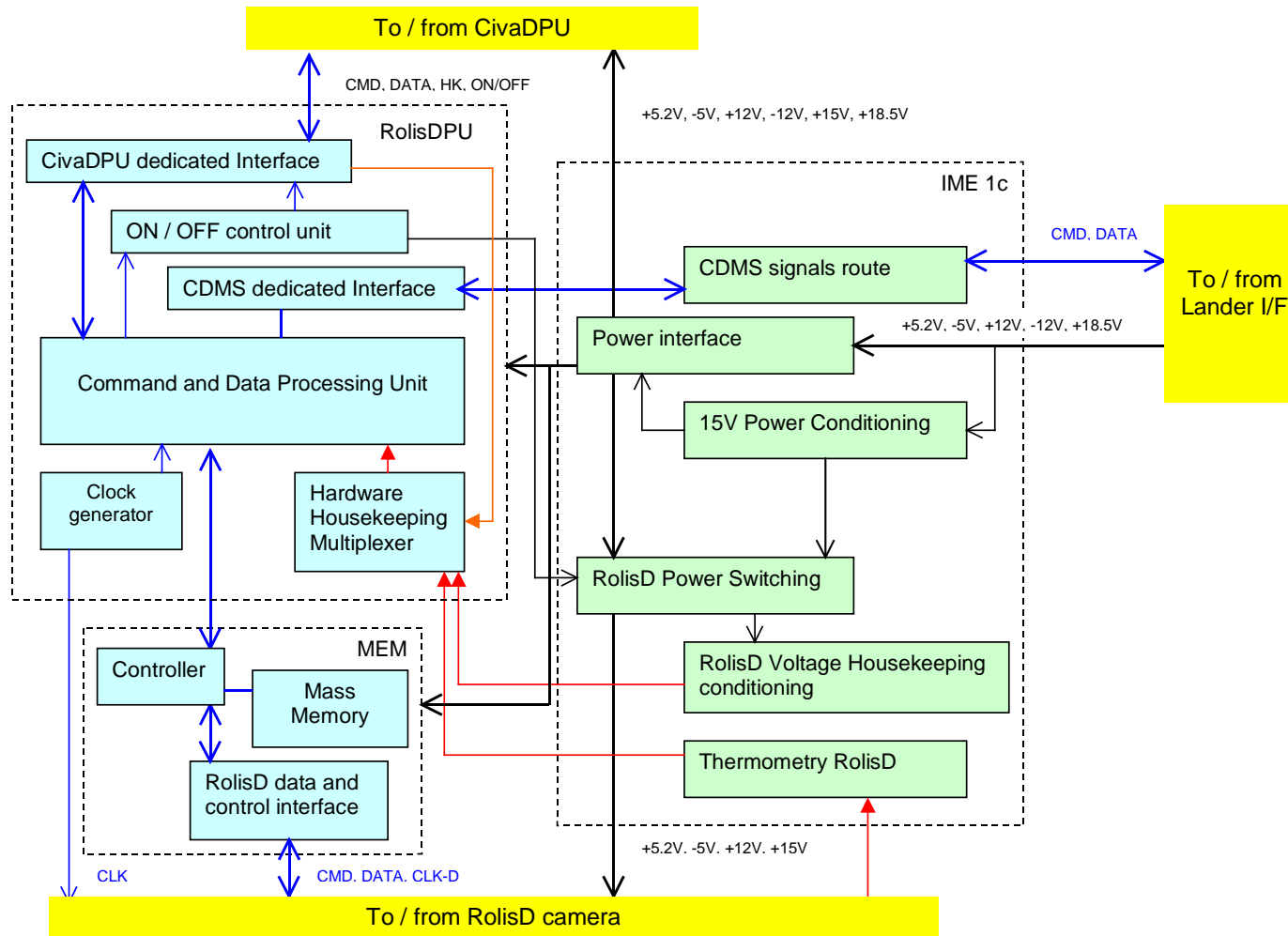

ROSETTA LANDER ÇIVA & ROLIS IME	Acceptance Data Package	
RO-LRS-ADP-3304	Issue 2.1	Model: FM

2.4 BUDGET DATA

2.4.1 Power Budget

Table 2.4.1-1: Power lines used by ROLIS / ÇIVA / IME and max. current

Input power lines from Lander	Current limit ² [I _{lim}]	Max.Typ. Current ³	By ROLIS / ÇIVA / IME used power lines	Used by
+18.5V	0.72 A	0.75 A	C+18.5V *	ÇIVA-CHs
			C+15V	ÇIVA-CHs
			D+15V	ROLIS-D
+12V	1.0 A	0.08 A	D+12V	ROLIS-D
			C+12V *	ÇIVA-CHs
+5.2V	2.3 A	1.96 A	R+5V *	ROLIS-IME digital
			A+5V *	ROLIS-IME analog
			D+5V	ROLIS-D
			C+5V *	ÇIVA-CE and ÇIVA-CHs
			ML+5V *	ROLIS-D / DRV & ID (Motor & LEDs)
-5V	2.4 A	0.09 A	A-5V *	ROLIS-IME analog
			D-5V	ROLIS-D
			C-5V *	ÇIVA-CHs
-12V	1.0 A	0.04 A	C-12V*	ÇIVA-CHs
+5V KAL	10mA	0	not used	not used
+28V	Not incl. in max. 22W ²	0.1	Direct input via connector J157	CivaHeaters

* these power lines are identical with the input power lines

² the summed output power should not exceed 22W

³ max. typical current, independently in which operation mode

The ROLIS and ÇIVA experiments will work under the nominal voltage conditions at the entrance of its ExpIF. The voltage range of the experiment power lines are given in the following table:

Table 2.4.1-2: voltage range of the experiment power lines

Nominal Voltage Range	Min. Voltage	Max. Voltage
-12V ^{+2%} _{-3%}	-12.24	-11.64
-5V ^{+2%} _{-3%}	+4.85	+5.10
+5.2V ^{+2%} _{-3%}	+5.04	+5.30
+12V ^{+2%} _{-3%}	+12.24	+11.64
+18.5V ^{+2%} _{-3%}	+18.87	+17.95

Table 2.4.1-3 shows the ROLIS and ÇIVA power consumption. Cf. also the ROLIS power figures in Section 15 of ROLIS & IME REIDB. [cf. attached Document in **annex 6** §11.6]

Table 2.4.1-3: ROLIS / CIVA / IME power consumption

Mode Name	Descript.	Max. current consumption [mA] (incl. "peaks" longer than 10ms)							Max. peak current consumption [mA] (shorter than 10ms) or inrush current [mA] (whatever is higher)							Power [W]	Produced Data [bytes]	Maturity (E/M)	Constraints
		+5.2V	-5V	+12V	-12 V	+28V main	+18.5V	KAL	+5.2V	-5V	+12V	-12V	+28V main	+18.5V	KAL				
Powerup	RolisIME on	390	10	0	0	N/A	0	N/A	1600*	40*	0	0	N/A	0	N/A	2.1			
DIS Or DIT	RolisIME+ RolisD on	530	40	75	0	N/A	35	N/A	800	300	900	0	N/A	500		4.4			
CUS or CUC	RolisIME+ RolisD + IFL or ID on	1960	40	75	0	N/A	35	N/A	2300	40	350	0	N/A	35		11.9			
ÇivaDPU on	RolisIME + ÇIVA-CE on	620	10																
	RolisIME + ÇIVA-CE+ ÇivaP on	1500	12				60		1500	12				530					
	RolisIME + ÇIVA-CE+ ÇivaP/S on	1500	12	18	6		160		1500	16	18	6		530					
	RolisIME + ÇIVA-CE+ ÇivaMV on	1600	12	10	5	/	60		1600					530					
	RolisIME + ÇIVA-CE+ ÇivaMI on	1600	90	30	35	/	750		1600		60								
	RolisIME + ÇivaHeater on	/	/	/	/	100							/						
	ÇivaHeater on	/	/	/	/	15							/						

ROSETTA LANDER ÇIVA & ROLIS IME	Acceptance Data Package	
RO-LRS-ADP-3304	Issue 2.1	Model: FM

2.4.2 Mass Budget

The following table 2.4.2 gives a mass budget of the ÇIVA / ROLIS Imaging Main Electronics.

Table 2.4.2: ÇIVA / ROLIS Imaging Main Electronics (EQM)

Item	Mass [kg]	Remarks
PIF (IME 2-00F-1)	0.329	Weighting
RolisDPU (ROLIS 2-01F-1)	0.099	
MEM (ROLIS 2-02F-1)	0.104	
Çiva-DPU (ÇIVA 2-08F-1)	0.397	Including holding support
ÇivaMID (ÇIVA 2-09F-1)	0.101	
IME total	1.030	

2.4.3 Memory Budget

See § 5.3 : Memory allocation table of RolisIME.

3 MECHANICAL AND THERMAL DATA

3.1 MECHANICAL INTERFACE AND OVERVIEW DRAWINGS

Figure 3.1-1 shows the overview about the mechanical interfaces of IME as side view. The figure 3.1-2 shows in detail the ÇIVA-part of IME.

Overview drawings of cover plate (CP) are compiled in **Annex 1** §11.1.

Figure 3.1-1: Side view of ROLIS & ÇIVA Imaging Main Electronics (IME)

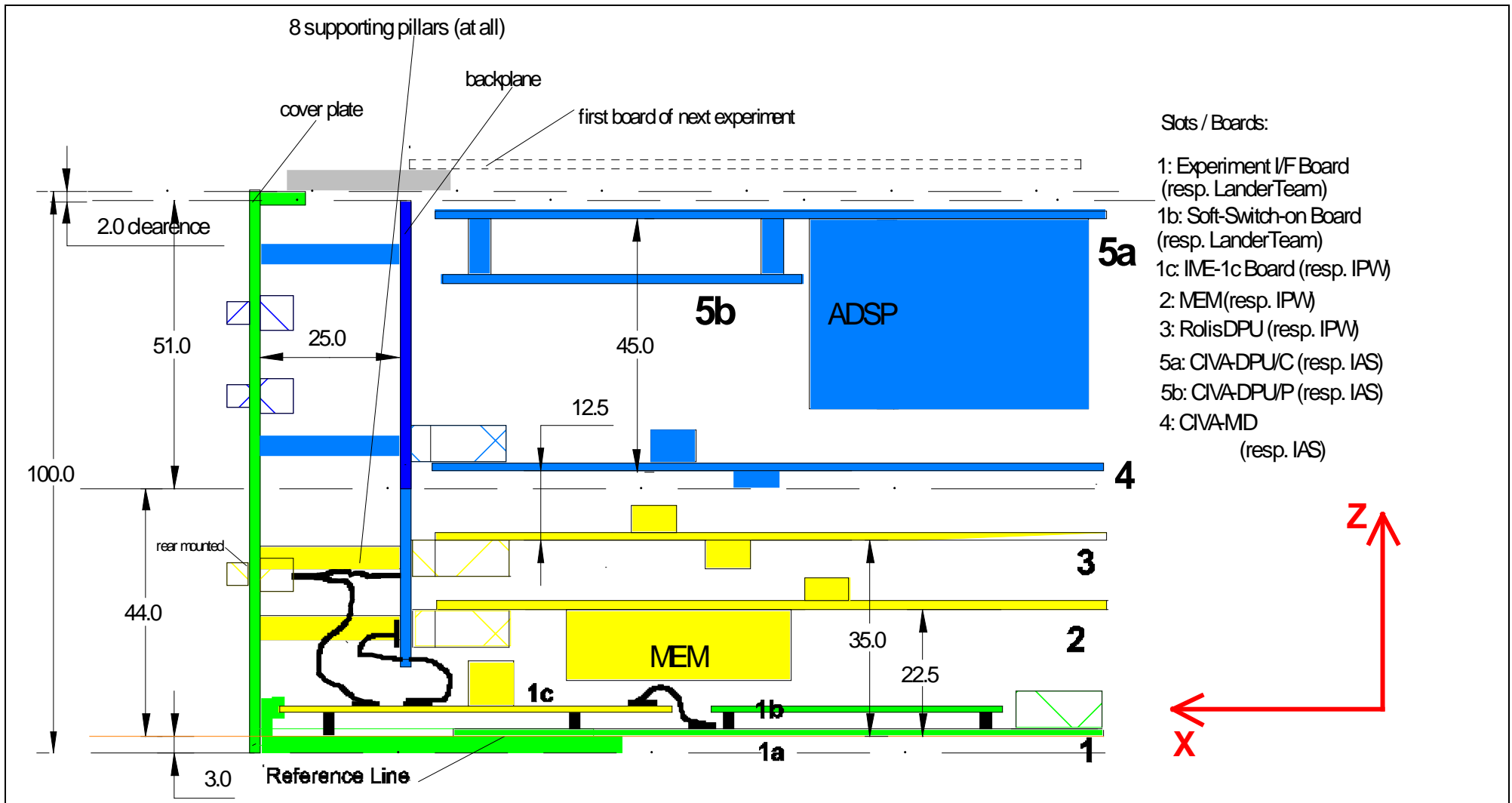
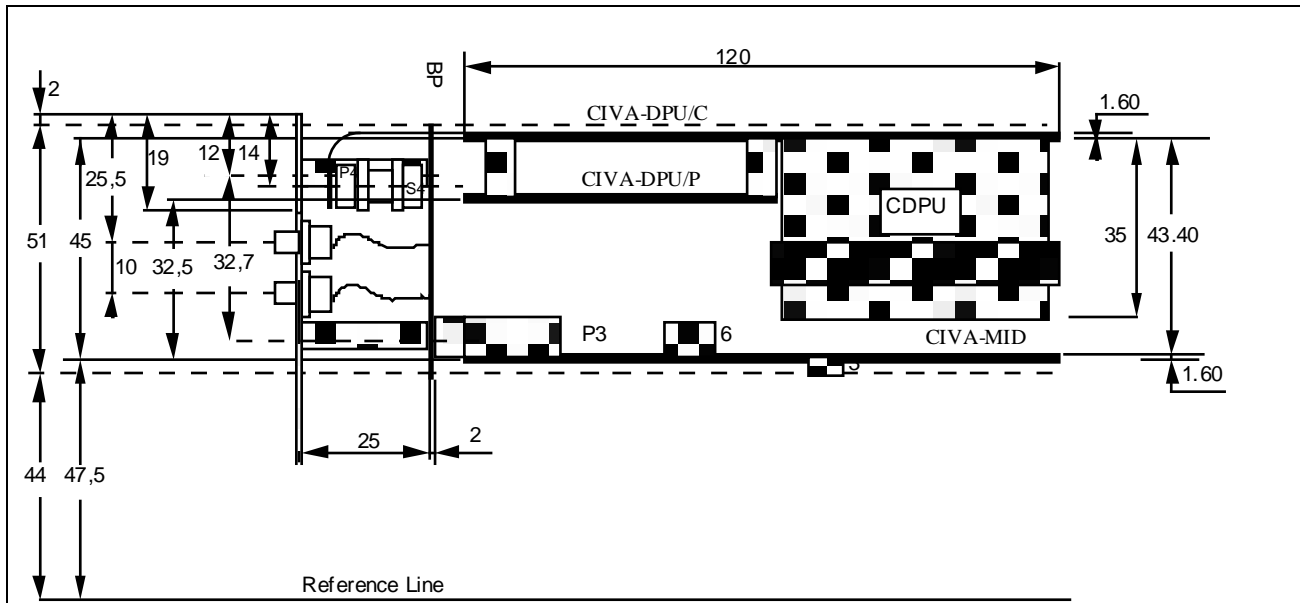

Figure 3.1-2: ÇIVA-part of IME



3.2 ALIGNMENT REQUIREMENTS

The IME will be pushed in $-x$ direction into the CEB using the guiding rails inside the CEB. The coordinates of IME are identical oriented as for the CEB and shown in Fig. 3.1.-1.

3.3 THERMAL BUDGET DATA

The max. increase of temperature during operation at max. temperature does not exceed $+14\text{ }^{\circ}\text{C}$.

3.4 THERMAL INTERFACE CONTROLLED DRAWING

The Thermal Reference Point (TRP) for RolisIME is located on the top (mid) of the processor chip of the RolisDPU board.

ROSETTA LANDER ÇIVA & ROLIS IME	Acceptance Data Package	
RO-LRS-ADP-3304	Issue 2.1	Model: FM

4 ELECTRICAL DATA

4.1 ELECTRICAL INTERFACE AND OVERVIEW DRAWINGS

ROLIS, ÇIVA and their IME have a common power interface to the PSS. The power lines for ROLIS / ÇIVA / IME (-12V; -5V; +5.2V; +12V; +18.5V) are coming via the Experiment I/F board (**ROLIS 2- 07F**) to the IME-1c board (**ROLIS 2- 03F**).

The +28V power will be used by ÇIVA heaters only and is interfaced via an extra connector (J157) on the IME CoverPlate.

The used by ROLIS / ÇIVA / IME power levels are:

-12V; -5V; +5.2V; +12V; +15V; +18.5V; +28V.

The +15V is derived from the +18.5V on the IME-1c board (**ROLIS 2- 03F**), which distributes all power lines to ROLIS and ÇIVA in parallel. The ÇIVA power lines will be switched on/off by a switch controlled by RolisDPU. The Ground Reference Point for all power lines and signal lines is the common ground (ComGND). Inside the IME the electrical ComGND is not connected to chassis (mechanical ground).

Table 2.4.1-1 shows the power lines used by ROLIS / CIVA / IME and max. currents, independently of the mode. Table 2.4.1-3 contains the ROLIS / CIVA / IME power consumption in different operation modes.

4.2 ELECTRICAL DETAILS SCHEMATICS

The incoming power lines are T-filtered on the input of the IME-1c board (**ROLIS 2- 03F**) except the +5.2V-power line. The +5.2V-power line is only C-filtered. For details see the documentation of IME-1c board [RO-LRS-DS-4423] (see **Annex 16**, § 11.16.3).

4.3 GROUNDING DIAGRAM

The Grounding diagram is shown in the Section 5.2 of the ROLIS & IME REIDB (**annex 6** § 11.6).

4.4 PIN ALLOCATION TABLE

4.4.1 IME internal harness

The IME internal harness is schematically shown on figure 4.4.1-1. The scheme corresponds to the connection scheme listed in table 4.4-1 and the connection scheme of CP in figure 4.4.1-2, which shows the slot pin allocation.

Figure 4.4.1-1: Electrical I/F overview

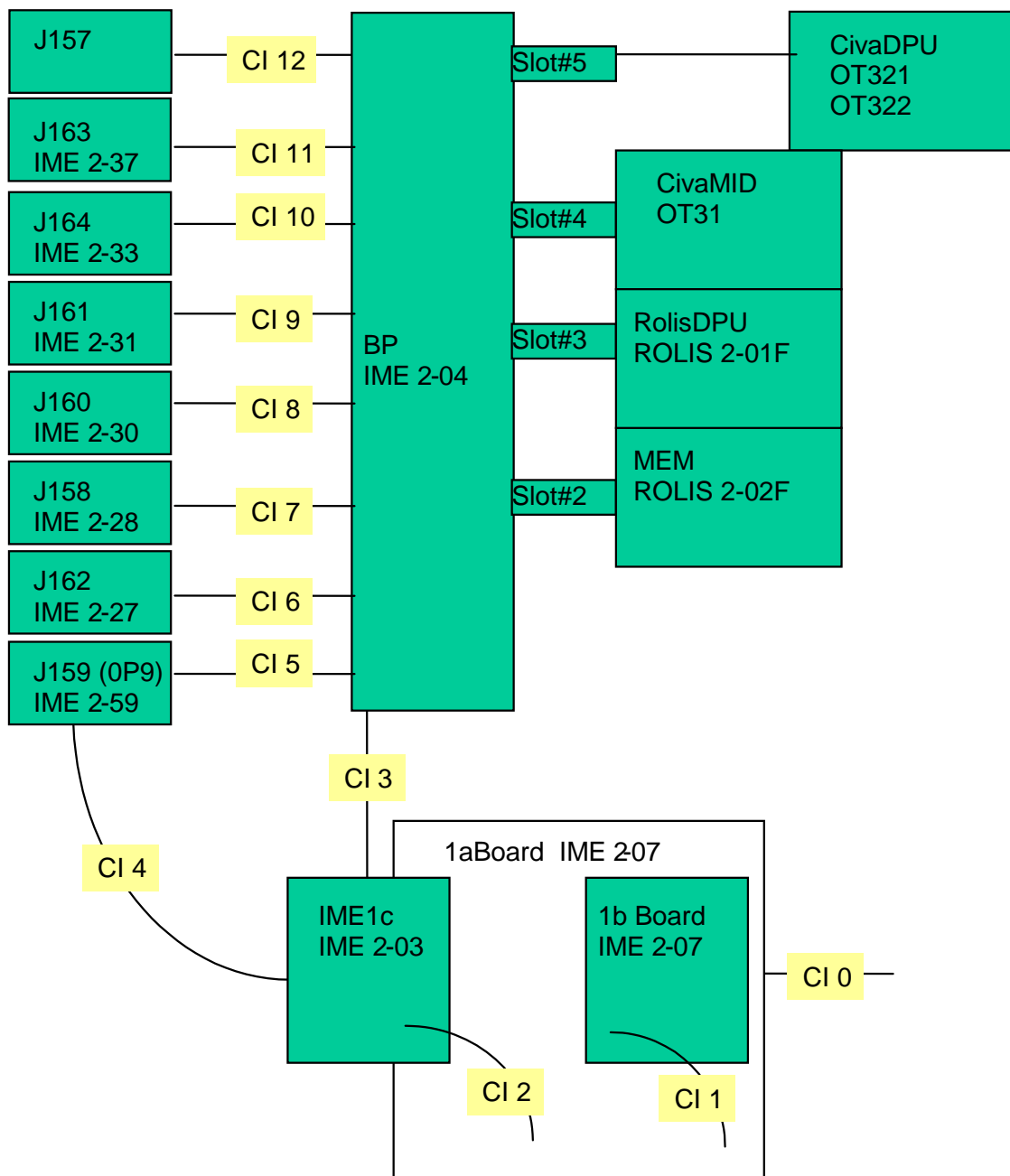

ROSETTA LANDER ÇIVA & ROLIS IME	Acceptance Data Package
RO-LRS-ADP-3304	Issue 2.1
	Model: FM

Table 4.4.1-1: Where are the connections /cables described which are shown in Fig. 4.4.1-1?

Connection /cable	Where described
CI 0	Electronic I/F Board delivery documentation (MPAe)
CI 1	Electronic I/F Board delivery documentation (MPAe)
CI 2	Table 4.4.1-2
CI 3	Table 4.4.1-2
CI 4	Table 4.4.1-2
CI 5	Section 4.4.2-J157 (sub-quantity)
CI 6	Section 4.4.2-J162
CI 7	Section 4.4.2-J158
CI 8	Section 4.4.2-J160
CI 9	Section 4.4.2-J161
CI 10	Section 4.4.2-J164
CI 11	Section 4.4.2-J163
CI 12	Section 4.4.2-J157
Slot#2	Section 11.16 (Annex 16-2)
Slot#3	Section 11.16 (Annex 16-1)
Slot#4	Section 11.16 (Annex 16-5) To be confirmed
Slot#5	Section 11.16 (Annex 16-5) To be confirmed

Table 4.4.1-2: RolisIME internal harness list (FM)

No.	From Subunit	Pin orientation	To Subunit	Per cable	Signal	Wire	
1	IME1c-Board (IME 2-03)	-X axis	IME 1a-Board (IME 2-07)	CI 2	GND (ComGND)	AWG 24	
2					+12V		
3					HKI+5.2V		AWG 28
4					+5V (+5.2V)		
5					-5V		
6					-12V		
7					+18.5V		
8					CMD-A (CMD_M)		AWG 28
9					CLK-A (CLK_M)		
10					DATA-A (DATA_M)		
11					CMD-B (CMD_R)		
12					CLK-B (CLK_R)		
13					DATA-B (DATA_R)		
							TOUCH
14			GND (ComGND)	AWG 24			
15		+Y axis	BP (IME 2-04)	CI 3	ComGND	AWG 24	
					TOUCH	AWG 28	
16					DATA-B	AWG 28	
17					CLK-B		
18					CMD-B		
19					DATA-A		
20					CLK-A		
21					CMD-A		
22					R+5V (digital)	AWG 24	
23					ComGND		
24	Rolis_TMP (TRD)	AWG 28					

No.	From Subunit	Pin orientation	To Subunit	Per cable	Signal	Wire	
25		+X axis	BP (IME 2-04)	CI 3	Rolis_Don	AWG 28	
26					HKI+5.2V		
27					U5N_D		
28					U5P_D		
29					U12P_D – N/C		
30					U15P_D		
31			J159 (0P9) (IME 2-59)		CI 4	ComGND (Shield)	AWG 26
32						ComGND (Shield)	
33						ComGND (Shield)	
34						ComGND	
35		D-5V					
36		ComGND					
37		ComGND					
38		D+5V					
39		D+5V					
40		ComGND					
41		ComGND					
42		D+12V					
43		D+12V					
44		ComGND					
45		+15V					
46		ComGND					
47		ComGND					
48		ML+5V					
49		ML+5V					
50		TS_D_return					
51		TS_D					
52		IME1c-Board (IME 2-03)	+Y axis	BP (IME 2-04)	CI 3	C-12V	AWG 24
53						ComGND	
54						C+5V	
55						ComGND	
56	C-5V						
57	ComGND						
58	C+12V						
59	ComGND						
60	C+15V						
61	C+18.5V						
62	ComGND						
63	A-5V						
64	A+5V						

ROSETTA LANDER ÇIVA & ROLIS IME		Acceptance Data Package	
RO-LRS-ADP-3304	Issue 2.1	Model: FM	

4.4.2 ÇIVA interface connectors

Pin allocation of connector J162

Pin	Signal name
1	CLK_OUT_P
2	
3	DATA_OUT_P
4	GND
5	CLK_P_IN_N
6	CMD_P_IN_P
7	
8	
9	
10	
11	

Pin	Signal name
12	CLK_OUT_N
13	+5V
14	DATA_OUT_N
15	GND
16	CLK_P_IN_P
17	CMD_P_IN_N
18	
19	
20	+15V
21	

Pin allocation of connector J163

Pin	Signal name
1	ON_OFF_CH1
2	ON_OFF_CH2
3	ON_OFF_CH3
4	ON_OFF_CH4
5	
6	HEAT_CH1_2_6_7
7	HEAT_CH3_4_5
8	
9	TSC1
10	TSC2
11	TSC3
12	TSC4
13	
14	
15	
16	

Pin	Signal name
17	ON_OFF_CH5
18	ON_OFF_CH6
19	ON_OFF_CH7
20	
21	HEAT_R_CH1_2_6_7
22	HEAT_R_CH3_4_5
23	
24	TSC5
25	TSC6
26	TSC7
27	TSC_R
28	
29	
30	COV_A
31	COV_B

Pin allocation of connector J158

Pin	Signal name
1	CLK_OUT_P
2	
3	DATA_OUT_P
4	GND
5	CLK_M_IN_N
6	CMD_M_IN_P
7	HEAT_R_CH8
8	
9	ON_OFF_CH8
10	
11	TSC8

Pin	Signal name
12	CLK_OUT_N
13	+5V
14	DATA_OUT_N
15	GND
16	CLK_M_IN_P
17	CMD_M_IN_N
18	HEAT_CH8
19	
20	+15V
21	TSC8_R

Pin allocation of connector J160

Pin	Signal name
1	VDD
2	MC (CLK)
3	CAP1
4	TH+V
5	TH+I
6	DEADPOT
7	ABAMPHI
8	COLHI
9	
10	DIGATE
11	DSUB
12	ABOUT
13	

Pin	Signal name
14	VSS
15	INT
16	CAP2
17	TH-V
18	TH-I
19	
20	ABAMPLO
21	MC(RET)
22	
23	
24	AB_RET
25	TESTB

Pin allocation of connector J161

Pin	Signal name
1	LAMP_A
2	SHUTC_A
3	GRAT_PH1_A
4	GRAT_PH2_A
5	
6	GRAT_ST1
7	TSC9
8	TSC10

Pin	Signal name
9	LAMP_B
10	SHUTC_B
11	GRAT_PH1_B
12	GRAT_PH2_B
13	
14	GRAT_ST2
15	TSC_R

Pin allocation of connector J164

Pin	Signal name
1	LED1
2	LED2
3	LED3
4	
5	TSC11

Pin	Signal name
6	LED_+5V
7	LED_+5V
8	
9	TSC11_R

Pin allocation of connector J157

Pin	Signal name
1	+28V
2	
3	28VR
4	
5	

Pin	Signal name
6	+28V
7	
8	28VR
9	

ROSETTA LANDER ÇIVA & ROLIS IME	Acceptance Data Package	
RO-LRS-ADP-3304	Issue 2.1	Model: FM

4.4.3 RolisD interface connector

Pin allocation of connector J159 (0P9)

Pin	Signal name
1	CLK+
2	ComGND
3	CMD+
4	CMD_RDY+
5	TS-D
6	DTA+
7	D_RDY+
8	ComGND
9	D-5V
10	D+5V
11	D+5V
12	D+12V
13	D+12V
14	D+15V
15	ML+5V
16	ML+5V

Pin	Signal name
17	CLK-
18	CMD-
19	CMD_RDY-
20	ComGND
21	DTA-
22	D_RDY-
23	TS-D return
24	CLK_D+
25	ComGND
26	ComGND
27	CLK_D-
28	ComGND
29	ComGND
30	ComGND
31	ComGND

ROSETTA LANDER ÇIVA & ROLIS IME	Acceptance Data Package	
RO-LRS-ADP-3304	Issue 2.1	Model: FM

5 SOFTWARE

5.1 GENERAL REMARKS

This ADP contains the description of the ComDPU software (in PROM) and the ROLIS software (in EEPROM). It is a general feature of the ROLIS instrument that the ROLIS software can be completely or partially changed during flight by a software upload (cf. Sect.7.5).

5.1.1 Common-DPU vs. ROLIS-DPU

The RolisDPU is a ComDPU application. Its software contains the ComDPU debug monitor software (DEBx) in PROM and the ROLIS software in EEPROM.

After power-on the DEBx-PROM is copied to RAM and executed. In this mode (ComDPU mode) the RolisDPU accepts only DEBx telecommands (cf. Sect. 5.4.4) and issues ComDPU HK (cf. Sect. 5.5.1) and ComDPU messages (cf. Sect. 5.5.3). If the RolisDPU receives a DEBx command in the first minute after Experiment power On, it remains in the ComDPU-mode (Debug-mode). If there is no DEBx telecommand within 1 minute after power-on, the ROLIS software boots automatically and the instrument is able to issue ROLIS HK (cf. Sect. 5.5.1) and ROLIS science data (cf. Sect. 5.5.5).

5.1.2 ROLIS software configuration

The ROLIS software can be configured by various telecommands. It is also possible to save the current configuration in the EEPROM using the telecommand (hex) 5026. Then the saved configuration will be restored as the default after next power-on.

Especially for ground tests it is recommended to perform the complete ROLIS configuration using the telecommand (hex) 5021 FFFF in order to create a test mode with detailed status information in form of additional data frames.

The telecommand (hex) 5021 C6E0 reduces the status information again to a minimum (flight configuration).

5.2 FLOW CHART

The ROLIS software is written in FORTH (LMI-Forth relying on the FORTH-83 standard). FORTH is the native language for the RTX-2010 microprocessor used for the ComDPU. Although FORTH is considered to be a high-level language; it gives the best performance results for the RTX-2010.

Background tasks, performed in real-time, initiated by interrupts:

- Reception of CDMS CMD/DATA/STAT messages incl. status word handling (max. 16 received CMD messages can be buffered).

ROSETTA LANDER ÇIVA & ROLIS IME		Acceptance Data Package	
RO-LRS-ADP-3304	Issue 2.1	Model: FM	

- Service Request handling for science data frame output
- Housekeeping service
- A/D and MUX control for the first 16 HK channels
- Timer counter interrupts
- ÇIVA Interface I/O
- Reception of RolisD data (DMA by hardware)

The ROLIS software implements a cooperative multitasker switching between the following four foreground tasks:

- CDMS: message interpreter
- FRAME: Science data output
- ÇIVA: message interpreter
- ROLIS: Camera head control + image processing

The max. multitasker cycle is ≈ 10 msec, that means the CPU returns to the current task after max. ≈ 10 msec.

This property gives the ROLIS-S/W the possibility to work quasi parallel in these 4 tasks. That allows especially after touch-down

- to process the ROLIS descent data,
- to receive ROLIS telecommands from CDMS, f.i. for switching on the CivaDPU,
- to receive after then CIVA telecommands and transfer them to CIVA,
- to initiate frame output for ROLIS- and CIVA-data ready-to-telemetry.

Figure 5.2-1: Cooperative multitasking

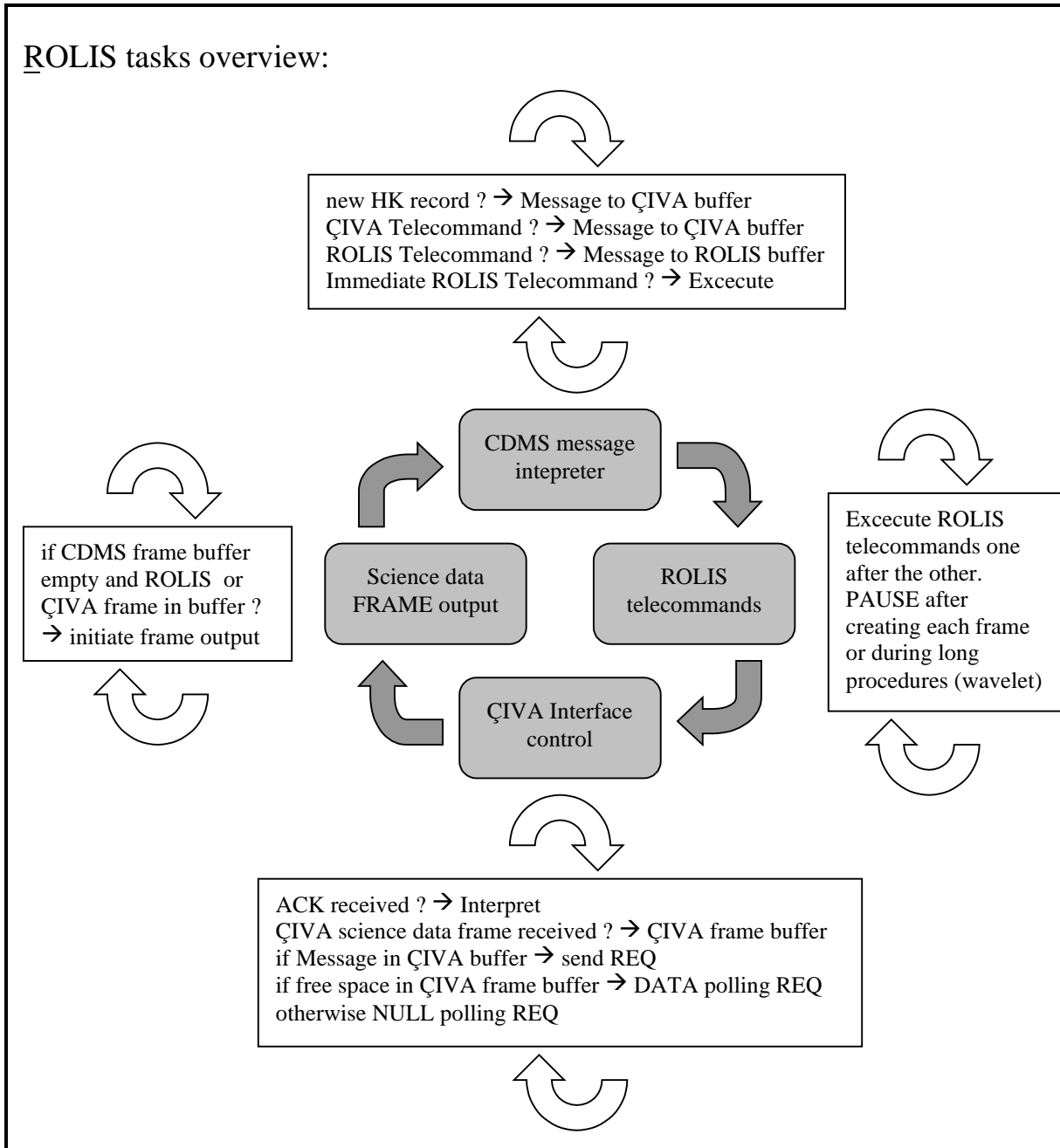

ROSETTA LANDER ÇIVA & ROLIS IME	Acceptance Data Package	
RO-LRS-ADP-3304	Issue 2.1	Model: FM

5.2.1 CDMS: message interpreter

CDMS messages are received and answered in real-time (interrupts). Messages which are not interpreted in real-time (telecommands, lander onboard time, ÇIVA-HK service) are stored in a ring-buffer (max. 16 messages).

The CDMS main loop repeatedly checks for received CDMS messages. This loop should be fast enough to avoid a CDMS ring-buffer overrun.

Buffered messages are forwarded to the ROLIS and ÇIVA tasks. Telecommands with the “immediate” flag set are executed immediately in the CDMS main loop (ref. 5.4.3).

5.2.2 FRAME: Science data output

ROLIS and ÇIVA science data frames are buffered in an image memory (of MEM board). A maximum of 1 MByte (4096 CDMS frames) can be stored for each experiment.

The FRAME task periodically checks for buffered science data frames and initiates the output to the CDMS. The output itself is performed by interrupt services.

There is no quota verification or data priority for ROLIS and ÇIVA. The frame task alternately checks for ROLIS and ÇIVA science data. If there are buffered frames for both instruments then ROLIS and ÇIVA frames are sent alternately.

ÇIVA frames are sent to the CDMS independently whether ÇIVA is switched on/off. Therefore ÇIVA can be switched off after all ÇIVA data has been transferred to MEM.

5.2.3 ÇIVA: ROLIS/ÇIVA interface

The ÇIVA interface is activated only after ÇIVA has been switched on by a ROLIS telecommand.

The ÇIVA task primarily checks for received ÇIVA telecommands, HK service requests or onboard-time messages and forwards them to ÇIVA.

Otherwise ÇIVA is polled for HK or science data, if there is space in the ÇIVA frame buffer.

The ÇIVA interface starts at 78 kHz, allowing a maximum science data transfer rate of ~8 kByte/sec.

ROLIS/ÇIVA interface messages are checksum verified. At transmission errors (checksum or timeout) the message is repeated max. 3 times. If these transmissions also fail the interface clock is reduced to 39 kHz. Transmission failures at the 39 kHz clock are ignored after 3 repetitions.

5.2.4 ROLIS: Camera head control + image processing

ROSETTA LANDER ÇIVA & ROLIS IME		Acceptance Data Package
RO-LRS-ADP-3304	Issue 2.1	Model: FM

The ROLIS task executes ROLIS telecommands. Some of these procedures can run a long time (e.g. descent imaging for hours). In that case the ROLIS tasks pauses periodically to guaranty that other tasks are executed with a typical latency of ~10 milliseconds.

5.3 MEMORY ALLOCATION TABLE OF ROLIS-IME

RolisDPU:		
PROM	16 KB	ComDPU S/W; copied to RAM page#0 at power-on
EEPROM	64 KB	ROLIS S/W, copied to RAM page#0 at ROLIS S/W boot
RAM page#0	64 KB	ComDPU or ROLIS SW, Code and Data used for ROLIS-data processing (wavelet compression) optionally used as ROLIS / ÇIVA data buffer (2 x 32 Kbyte)
RAM page#1	64 KB	
RAM page#2	64 KB	
RAM page#3	64 KB	
MEM:		
MEM cube img buffer#0	2 MB	Image buffers; used for image storage + image processing img#7 default used as ROLIS / ÇIVA data* buffer (2 x 1 Mbyte)
MEM cube img buffer#1	2 MB	
MEM cube img buffer#2	2 MB	
MEM cube img buffer#3	2 MB	
MEM cube img buffer#4	2 MB	
MEM cube img buffer#5	2 MB	
MEM cube img buffer#6	2 MB	
MEM cube img buffer#7	2 MB	

* data ready for telemetry

5.4 ROLIS / ÇIVA TELECOMMANDS

ROLIS receives telecommands for two experiments: ROLIS and ÇIVA. ÇIVA telecommands are forwarded to the ÇIVA-DPU via the internal interface without interpretation by the RolisDPU.

5.4.1 Telecommand verification

A telecommand can contain 1 to 32 command words in accordance with the CDMS specification. The telecommand length is verified with respect to the WRDC field of the SSADR word. If the length does not match, the CE flag (CDMS status word) is set and the command is ignored.

The ComDPU debug monitor commands (DEBx) are emergency commands. If there is no DEBx telecommand within 1 minute after power-on the ROLIS software is booted from EEPROM and no DEBx telecommands will be understood. DEBx telecommands can be used to perform :

- ComDPU health check

ROSETTA LANDER ÇIVA & ROLIS IME	Acceptance Data Package	
RO-LRS-ADP-3304	Issue 2.1	Model: FM

- Software patches
- Partial or complete software upload
- Dump raw memory data by CDMS science data frames
- Execute single processor instructions and procedures

These commands are checksum protected to avoid damaging of experiment software in EEPROM by accident.

5.4.2 Telecommand classification

To distinguish between the different modes and destinations of ROLIS / ÇIVA telecommands the following classification is introduced :

Table 5.4.2: ROLIS / ÇIVA classification of telecommands

1. Command Word (hex)	Destination	Remarks
DEBx	ComDPU debug monitor commands	Only in ComDPU mode: First telecommand must be received within 1 min after power-on, otherwise the ROLIS-SW is booted. length and checksum validation
Cxxx	ÇIVA telecommands	Not verified or interpreted, but forwarded to ÇIVA-DPU if switched on. length and checksum validation
5fcc	ROLIS telecommands	Max 256 different telecommands. length, command code and checksum validation
	f = 0,8	8: Immediate flag: command will be executed immediately after reception; 0: No immediate flag: Ordinary telecommands are piped and executed in the order of reception.
	cc = 0..255	Telecommand code
Efcc	ROLIS-EGSE telecommands (f,cc same as above)	not implemented in flight software, length, code and checksum validation
2.-max. 31. Words	Destination	Remarks
	telecommand parameters	Note that there are some telecommands with a variable number of parameters, because the command length is known from the WRDC field in the CDMS SSADR word.
last Word	Destination	Remarks
	Telecommand checksum	Sum of the whole telecommand (incl. checksum) = 0000

5.4.3 ROLIS “immediate” telecommands, order of execution

ROSETTA LANDER ÇIVA & ROLIS IME	Acceptance Data Package	
RO-LRS-ADP-3304	Issue 2.1	Model: FM

Normal ROLIS telecommands are executed in the order of their reception. These telecommands are executed in the ROLIS task (ref. Sect. 5.2). Some of the telecommands could need a long time for execution (Imaging, Data compression, Descent imaging mode).

The “Immediate” flag allows to execute the telecommand in parallel to a long-running process. In this case the telecommand is not in the ROLIS task, but “immediately” in the CDMS task (ref. Sect. 5.2). A typical application is to switch on/off ÇIVA during ROLIS image data processing.

The “Immediate” flag should not be used for long-running telecommands. Otherwise the CDMS message interpreter (CDMS task) could block, resulting in a telecommand lost for ROLIS and ÇIVA.

5.4.4 ROLIS: ComDPU debug monitor telecommands

5.4.4.1 DEBx command checksum protection and acknowledge

Debug-Monitor telecommands have the following general structure, including checksum protection :

Table 5.4.4.1 : General structure of DEBx commands

Telecommand format	Ident	Parameters	Checksum
CDMS telecommand sequence max. 32 binary words	One word DEB0..DEBF	max. 30 words	command id + parameters + check-sum = 0
Example:	DEB8 0001 2000 0080 00C7		

Every DEBx command received via the CDMS (except software upload) is acknowledged by a single ‘science’ data frame containing an ASCII message describing the executed telecommand. Messages starting with ‘ComDPU: M’ are success messages, messages starting with ‘ComDPU: E’ are error messages.

5.4.4.2 DEBx telecommand description

The following table 5.4.4.2 gives a brief overview of the available *Debug-Monitor* telecommands. The telecommand length is given including Ident, Parameter, and Checksum.

Table 5.4.4.2: DEBx Command Overview

Ident (hex)	Telecommand name	Length	Parameters	Description
DEB0	File Upload	5	RAM-PAGE, RAM-ADR, LEN	Start file upload of LEN words to RAM
DEB1	File Data	3..32	DATA1,...,DATAn	File upload DATA words
DEB2	File End	3	CHECKSUM	End of file upload, verify checksum
DEB3	Burn EEPROM File	3	EE-ADR	Burn uploaded file into EEPROM (file mode)
DEB4	Execute File	2		Execute uploaded file (RAM-PAGE=0 !)
DEB5	Write EEPROM	6	RAM-PAGE, RAM-ADR, EE-ADR, LEN	Burn RAM contents into EEPROM (raw mode)
DEB6	Execute Code	3..32	CODE1,...,CODEn	Execute a machine code sequence
DEB7	Read EEPROM	6	EE-ADR, RAM-PAGE, RAM-ADR, LEN	Read out EEPROM contents to RAM
DEB8	Dump RAM	5	RAM-PAGE, RAM-ADR, LEN	Dump min. LEN words of RAM to CDMS data frame
DEB9	Fill RAM	6..32	RAM-PAGE, RAM-ADR, TIMES, PAT1,...,PATn	Fill RAM with pattern PAT1,...,PATn, repeat TIMES times
DEBA	Move RAM	7	RAM-PAGE, RAM-ADR, DEST-PAGE, DEST-ADR, LEN	Move (Copy) LEN words from one RAM address to another
DEBB	RAM Checksum	5	RAM-PAGE, RAM-ADR, LEN	Calculate RAM checksum by adding LEN words
DEBC	Boot RAM	5	RAM-PAGE, RAM-ADR, LEN	Move code from RAM to code page 0 and boot
DEBD	Boot EEPROM File	3	EE-ADR	Move code from EEPROM to code page 0 and boot (with checksum verification)

ROSETTA LANDER ÇIVA & ROLIS IME		Acceptance Data Package	
RO-LRS-ADP-3304	Issue 2.1	Model: FM	

5.4.5 ÇIVA telecommands

5.4.5.1 Overall Description

Telecommands directed to ÇIVA are received, length-checked and checksum validated by the RolisDPU. These commands are immediately (with a typical latency of ≈ 10 msec) forwarded to the ÇivaDPU via the internal DPU / DPU interface. No telecommand interpretation is performed by ROLIS. ÇIVA takes the full responsibility for the definition of these telecommands.

Table 5.4.5.1-1: Structure of ÇIVA telecommands

Telecommand format	Command ID	Parameters	CS
CDMS telecommand sequence Action Code (ACTC) =8 (RCMD)	One word C000..CFFF	≤ 31 words	1 word

The basic and detailed format of one packet of ÇIVA Telecommands are given in tables 5.4.5.1-2 and 5.4.5.1-3 respectively.

ROSETTA LANDER ÇIVA & ROLIS IME		Acceptance Data Package	
RO-LRS-ADP-3304	Issue 2.1	Model: FM	

Table 5.4.5.1-2: Basic format of ÇIVA telecommands

	b15	b14	b13	b12	b11	b10	b9	b8	b7	b6	b5	b4	b3	b2	b1	b0	
W0	Çiva Header																
W1	nb_clean			0		Çiva-M/I			Çiva-M/V			Çiva-P #5			Çiva-P #4		
W2	Çiva-P #4	Çiva-P #3			Çiva-P #2			Çiva-P #1			Çiva-P #7			Çiva-P #6			
W3	tacq/32 (ms) #6							mcomp #6									
W4	cmd header #6											gain #6					
W5	tacq/32 (ms) #7							mcomp #7									
W6	cmd header #7											gain #7					
W7	tacq/32 (ms) #1							mcomp #1									
W8	cmd header #1											gain #1					
W9	tacq/32 (ms) #2							mcomp #2									
W10	cmd header #2											gain #2					
W11	tacq/32 (ms) #3							mcomp #3									
W12	cmd header #3											gain #3					
W13	tacq/32 (ms) #4							mcomp #4									
W14	cmd header #4											gain #4					
W15	tacq/32 (ms) #5							mcomp #5									
W16	cmd header #5											gain #5					
W17	tacq/32 (ms) MV IR							mcomp MV IR									
W18	cmd header MV IR											gain MV IR					
W18	tacq/32 (ms) MV Green							mcomp MV Green									
W20	cmd header MV Green											gain MV Green					
W21	tacq/32 (ms) MV Red							mcomp MV Red									
W22	cmd header MV Red											gain MV Red					
W23	nbstep MI							mcomp MI									
W24	cmd header MI			t1		dec			t2								
W25	E2 deadpot							E3 testb									
W26	E4 vref							end_IR			niv_IR			sub_flag			
W27	Chang_IR			CAP			0		0		int11		int10		int9		
W28	int8		int7		int6		int5		int4		int3		int2		int1		
W29	IME Commands Check Sum																

ROSETTA LANDER ÇIVA & ROLIS IME	Acceptance Data Package	
RO-LRS-ADP-3304	Issue 2.1	Model: FM

Table 5.4.5.1-3: Detailed format of ÇIVA telecommands

The parameters of the telecommands are detailed in the following table:

Word Nb	Parameter		Description	Format		
	Nb	Label				
W0		Çiva Header	Header	C000 hex		
W1	#1	nb_clean	Number of cleaning up images from 0 to 15 before image taking	4 bits 15, 14, 13, 12		
		Çiva-M/I	Çiva-M/I instrument enable/disable	3 bits 10, 9, 8 all 1 = enable; all 0 = disable		
		Çiva-M/V	Çiva-M/V instrument enable/disable	3 bits 7, 6, 5 all 1 = enable; all 0 = disable		
		Çiva-P #5	Çiva-P #5 camera enable/disable	3 bits 4, 3, 2 all 1 = enable; all 0 = disable		
		Çiva-P #4	Çiva-P #4 camera enable/disable	2 MST bits 1, 0 all 1 = enable; all 0 = disable		
		W2		Çiva-P #4	Çiva-P #4 camera enable/disable	1 LST bits 15 1 = enable; 0 = disable
				Çiva-P #3	Çiva-P #3 camera enable/disable	3 bits 14, 13, 12 all 1 = enable; all 0 = disable
				Çiva-P #2	Çiva-P #2 camera enable/disable	3 bits 11, 10, 9 all 1 = enable; all 0 = disable
				Çiva-P #1	Çiva-P #1 camera enable/disable	3 bits 8, 7, 6 all 1 = enable; all 0 = disable
				Çiva-P #7	Çiva-P #7 camera enable/disable	3 bits 5, 4, 3 all 1 = enable; all 0 = disable
Çiva-P #6	Çiva-P #6 camera enable/disable			3 bits 2, 1, 0 all 1 = enable; all 0 = disable		
W3	#2			tacq/32 (ms) #6	Çiva-P #6 camera acquisition time modulo 32 ms	1 byte: bits 15 to 8
		mcomp #6	Çiva-P #6 camera compression mode	bit 7 0 = image acquisition enable 1 = simulated image bit 6 0 fixed = spatial bits 5 to 0: ibr all 0 = bit packing all 1 = reversible compression all ≠ 0, 1 = 16*bit/data		
		cmd header #6	Çiva-P #6 camera command header	12 MSB = CC4 hex (fixed)		
W4		gain #6	Çiva-P #6 camera amplification gain	4 LSB 3, 2, 1, 0		
W5	#3	tacq/32 (ms) #7	Çiva-P #7 camera acquisition time modulo 32 ms	1 Byte: bits 15 to 8		
		mcomp#7	Çiva-P #7 camera compression mode	bit 7 0 = image acquisition enable 1 = simulated image bit 6 0 fixed = spatial bits 5 to 0: ibr all 0 = bit packing all 1 = reversible compression all ≠ 0, 1 = 16*bit/data		
W6		cmd header #7	Çiva-P #7 camera command header	12 MSB = CC4 hex (fixed)		
		gain #7	Çiva #7 camera amplification gain	4 LSB 3, 2, 1, 0		

ROSETTA LANDER ÇIVA & ROLIS IME		Acceptance Data Package	
RO-LRS-ADP-3304		Issue 2.1	Model: FM

Word Nb	Parameter		Description	Format
	Nb	Label		
W7	#4	tacq/32 (ms) #1	Çiva-P #1 camera acquisition time modulo 32 ms	1 Byte: bits 15 to 8
		mcomp#1	Çiva-P #1 camera compression mode	bit 7 0 = image acquisition enable 1 = simulated image bit 6 0 fixed = spatial bits 5 to 0: ibr all 0 = bit packing all 1 = reversible compression all ≠ 0, 1 = 16*bit/data
W8	#4	cmd header #1	Çiva-P #1 camera command header	12 MSB = CC4 hex (fixed)
		gain #1	Çiva-P #1 camera amplification gain	4 LSB 3, 2, 1, 0
W9	#5	tacq/32 (ms) #2	Çiva-P #2 camera acquisition time modulo 32 ms	1 Byte: bits 15 to 8
		mcomp#2	Çiva-P #2 camera compression mode	bit 7 0 = image acquisition enable 1 = simulated image bit 6 0 fixed = spatial bits 5 to 0: ibr all 0 = bit packing all 1 = reversible compression all ≠ 0, 1 = 16*bit/data
W10	#5	cmd header #2	Çiva-P #2 camera command header	12 MSB = CC4 hex (fixed)
		gain #2	Çiva-P #2 camera amplification gain	4 LSB 3, 2, 1, 0
W11	#6	tacq/32 (ms) #3	Çiva-P #3 camera acquisition time modulo 32 ms	1 Byte: bits 15 to 8
		mcomp#3	Çiva-P #3 camera compression mode	bit 7 0 = image acquisition enable 1 = simulated image bit 6 0 fixed = spatial bits 5 to 0: ibr all 0 = bit packing all 1 = reversible compression all ≠ 0, 1 = 16*bit/data
W12	#6	cmd header #3	Çiva-P #3 camera command header	12 MSB = CC4 hex (fixed)
		gain #3	Çiva-P #3 camera amplification gain	4 LSB 3, 2, 1, 0
W13	#7	tacq/32 (ms) #4	Çiva-P #4 camera acquisition time modulo 32 ms	1 Byte: bits 15 to 8
		mcomp#4	Çiva-P #4 camera compression mode	bit 7 0 = image acquisition enable 1 = simulated image bit 6 0 fixed = spatial bits 5 to 0: ibr all 0 = bit packing all 1 = reversible compression all ≠ 0, 1 = 16*bit/data
W14	#7	cmd header #4	Çiva-P #4 camera command header	12 MSB = CC4 hex (fixed)
		gain #4	Çiva-P #4 camera amplification gain	4 LSB 3, 2, 1, 0

Word Nb	Parameter		Description	Format
	Nb	Label		
W15	#8	tacq/32 (ms) #5	Çiva-P #5 camera acquisition time modulo 32 ms	1 Byte: bits 15 to 8
		mcomp #5	Çiva-P #5 camera compression mode	bit 7 0 = image acquisition enable 1 = simulated image bit 6 0 fixed = spatial bits 5 to 0: ibr all 0 = bit packing all 1 = reversible compression all ≠ 0, 1 = 16*bit/data
	cmd header #5	Çiva-P #5 camera command header	12 MSB = CC4 hex (fixed)	
W16	#8	gain #5	Çiva-P #5 camera amplification gain	4 LSB 3, 2, 1, 0
		cmd header MV IR	Çiva-M/V IR camera command header	12 MSB = CC4 hex (fixed)
W17	#9	tacq/32 (ms) MV IR	Çiva-M/V IR camera acquisition time modulo 32 ms	1 Byte: bits 15 to 8
		mcomp MV IR	Çiva-M/V IR camera compression mode	bit 7 0 = image acquisition enable 1 = simulated image bit 6 0 fixed = spatial bits 5 to 0: ibr all 0 = bit packing all 1 = reversible compression all ≠ 0, 1 = 16*bit/data
	gain MV IR	Çiva-M/V IR camera amplification gain	4 LSB 3, 2, 1, 0	
W18	#9	cmd header MV IR	Çiva-M/V IR camera command header	12 MSB = CC4 hex (fixed)
		gain MV IR	Çiva-M/V IR camera amplification gain	4 LSB 3, 2, 1, 0
W19	#10	tacq/32 (ms) MV Green	Çiva-M/V Green camera acquisition time modulo 32 ms	1 Byte: bits 15 to 8
		mcomp MV Green	Çiva-M/V Green camera compression mode	bit 7 0 = image acquisition enable 1 = simulated image bit 6 0 fixed = spatial bits 5 to 0: ibr all 0 = bit packing all 1 = reversible compression all ≠ 0, 1 = 16*bit/data
	cmd header MV Green	Çiva-M/V Green camera command header	12 MSB = CC4 hex (fixed)	
W20	#10	gain MV Green	Çiva-M/V Green camera amplification gain	4 LSB 3, 2, 1, 0
		cmd header MV Red	Çiva-M/V Red camera command header	12 MSB = CC4 hex (fixed)
W21	#11	tacq/32 (ms) MV Red	Çiva-M/V Red camera acquisition time modulo 32 ms	1 Byte: bits 15 to 8
		mcomp MV Red	Çiva-M/V Red camera compression mode	bit 7 0 = image acquisition enable 1 = simulated image bit 6 0 fixed = spatial bits 5 to 0: ibr all 0 = bit packing all 1 = reversible compression all ≠ 0, 1 = 16*bit/data
	gain MV Red	Çiva-M/V Red camera amplification gain	4 LSB 3, 2, 1, 0	
W22	#11	cmd header MV Red	Çiva-M/V Red camera command header	12 MSB = CC4 hex (fixed)
		gain MV Red	Çiva-M/V Red camera amplification gain	4 LSB 3, 2, 1, 0

Word Nb	Parameter		Description	Format
	Nb	Label		
W23	#12	nbstep MI	Çiva-M/I number of grating steps from reference to first spectral position	1 Byte: bits 15 to 8
		mcomp MI	Çiva-M/I compression mode	bit 7 0 = image acquisition enable 1 = simulated image bit 6 1 fixed = spectral bits 5 to 0: ibr all 0 = bit packing all 1 = reversible compression all ≠ 0, 1 = 16*bit/data
W24	#12	cmd header MI	Çiva-M/I command header	4 MSB = 6 hex (fixed)
		t1	Çiva-M/I integration time parameter 1	bit 11 = 0 or 1 *
		dec	Çiva-M/I delay for the sampling and conversion time of the video signal wrt front edge of the master clock	3 bits 10, 9, 8 = 6 hex (default mode)
		t2	Çiva-M/I integration time parameter 2	1 Byte: bits 7 to 0 *
W25	#13	E2 deadpot	Çiva-M/I matrix reference and dead pixels level tuning	1 Byte: bits 15 to 8
		E3 testb	Çiva-M/I video signal simulation (used during ground test only)	1 Byte: bits 7 to 0 = FE hex (fixed for flight)
W26	#13	E4 vref	Çiva-M/I video signal offset tuning	1 Byte: bits 15 to 8
		end_IR	Çiva-M/I sub-units number from 1 to 11	4 bits 7 to 4 = 1 (sub-scan 0) = 2 (sub-scan 1) = 3 (sub-scan 2) = 11 (sub-scan 11)
		niv_IR	Çiva-M/I lamp supply voltage	2 bits 3, 2 = 0 hex (level 0) = 1 hex (level 1) = 2 hex (level 2) = 3 hex (level 3)
		sub_flag	Çiva-M/I dark current (DC) correction	2 LSB 1, 0 = 3 hex (DC subtraction) = 0 hex (no subtraction)
		chang_IR	Çiva-M/I first subcycle number of the scan with 64 positions	4 bits 15 to 12
W27	#14	CAP	Çiva-M/I detector gain parameter	4 bits 11 to 8
		int11	Çiva-M/I integration time index for subcycle #11 of the scan	2 bits 5 to 4 ** = 0 hex (time factor 1) = 1 hex (time factor 2) = 2 hex (time factor 5) = 3 hex (time factor 12)
		int10	Çiva-M/I integration time index for subcycle #10 of the scan	2 bits 3 to 2 ** = 0 hex (time factor 1) = 1 hex (time factor 2) = 2 hex (time factor 5) = 3 hex (time factor 12)
		int9	Çiva-M/I integration time index for subcycle #9 of the scan	2 bits 1 to 0 ** = 0 hex (time factor 1) = 1 hex (time factor 2) = 2 hex (time factor 5) = 3 hex (time factor 12)

ROSETTA LANDER ÇIVA & ROLIS IME		Acceptance Data Package	
RO-LRS-ADP-3304		Issue 2.1	Model: FM

Word Nb	Parameter		Description	Format
	Nb	Label		
W28		int8	Çiva-M/I integration time index for subcycle #8 of the scan	2 bits 15 to 14 ** = 0 hex (time factor 1) = 1 hex (time factor 2) = 2 hex (time factor 5) = 3 hex (time factor 12)
		int7	Çiva-M/I integration time index for subcycle #7 of the scan	2 bits 13 to 12 ** = 0 hex (time factor 1) = 1 hex (time factor 2) = 2 hex (time factor 5) = 3 hex (time factor 12)
		int6	Çiva-M/I integration time index for subcycle #6 of the scan	2 bits 11 to 10 ** = 0 hex (time factor 1) = 1 hex (time factor 2) = 2 hex (time factor 5) = 3 hex (time factor 12)
		int5	Çiva-M/I integration time index for subcycle #5 of the scan	2 bits 9 to 8 ** = 0 hex (time factor 1) = 1 hex (time factor 2) = 2 hex (time factor 5) = 3 hex (time factor 12)
		int4	Çiva-M/I integration time index for subcycle #4 of the scan	2 bits 7 to 6 ** = 0 hex (time factor 1) = 1 hex (time factor 2) = 2 hex (time factor 5) = 3 hex (time factor 12)
		int3	Çiva-M/I integration time index for subcycle #3 of the scan	2 bits 5 to 4 ** = 0 hex (time factor 1) = 1 hex (time factor 2) = 2 hex (time factor 5) = 3 hex (time factor 12)
		int2	Çiva-M/I integration time index for subcycle #2 of the scan	2 bits 3 to 2 ** = 0 hex (time factor 1) = 1 hex (time factor 2) = 2 hex (time factor 5) = 3 hex (time factor 12)
		int1	Çiva-M/I integration time index for subcycle #1 of the scan	2 bits 1 to 0 ** = 0 hex (time factor 1) = 1 hex (time factor 2) = 2 hex (time factor 5) = 3 hex (time factor 12)
W29		IME Check Sum	TC Words Check Sum	= -SUM(27 preceding TC Words)

* the basic or minimum integration time is defined by $t_i = 4.915 \cdot (t_1 \cdot 7 + 1) \cdot (t_2 + 1)$.

** the integration time for each activated subcycle (from 1 to 11 depending on the “end_IR” parameter as defined in W26) equals $t_i \cdot \text{time coefficient}$, the time factor being deduced from the corresponding group of 2 bits.

The following default parameters are programmed inside the Çiva:

W1,W2	0x201FFFFFF	7 cameras of Çiva-P activated with 2 cleans
W3,W4	0x1010CC4A	Çiva-P #7, 512 ms integration time, 1 bit/data, bias 4, gain 10
W5,W6	0x1010CC4A	Çiva-P #6, 512 ms integration time, 1 bit/data, bias 4, gain 10
W7,W8	0x1010CC4A	Çiva-P #1, 512 ms integration time, 1 bit/data, bias 4, gain 10
W9,W10	0x1010CC4A	Çiva-P #2, 512 ms integration time, 1 bit/data, bias 4, gain 10

ROSETTA LANDER ÇIVA & ROLIS IME		Acceptance Data Package	
RO-LRS-ADP-3304		Issue 2.1	Model: FM

W11,W12	0x1010CC4A	Çiva-P #3, 512 ms integration time, 1 bit/data, bias 4, gain 10
W13,W14	0x1010CC4A	Çiva-P #4, 512 ms integration time, 1 bit/data, bias 4, gain 10
W15,W16	0x1010CC4A	Çiva-P #5, 512 ms integration time, 1 bit/data, bias 4, gain 10
W17,W18	0x3E18CC4A	Çiva-M/V IR, 992 ms integration time, 1.5 bit/data, bias 4, gain 10
W19,W20	0xFF18CC4A	Çiva-M/V Green, 4080 ms integration time, 1.5 bit/data, bias 4, gain 10
W21,W22	0x3E18CC4A	Çiva-M/V Red, 992 ms integration time, 1.5 bit/data, bias 4, gain 10
W23,W24	0x84606611	Çiva-M/I, nbstep=132, image, 2 bits/data, t1=0, t2=17 (tacq~ 90 msec)
W25,W26	0xB9FE5ECB	Çiva-M/I, voltages E2, E3, E4, end_IR=12, niv_IR=2, DC subtraction
W27,W28	0x022BE500	Çiva-M/I, all cubes x 64, gain=2, int=0,0,0,1,1,2,3,3,2,2

During a 30 sec boot period (the PROM program is running) after being switched-on, ÇIVA waits for an initialisation TC. Since one contingency runs from 30 sec to 50 sec, if no TC is received within this 50 sec period, ÇIVA executes the default sequence (7 cameras of ÇIVA-P), with the default acquisition parameters (see above). An initialisation TC can contain any number of 32 bits words, which overwrite, starting from the first, the 14 words of the default sequence. As an example, any unit can be activated with its default acquisition parameters by overwriting word 1 with the proper bit setting.

Note: the 20 sec contingency is only acceptable for nominal operation but not for upload process. Then the upload initialisation TC needs to be received within the 30 sec period after ÇIVA DPU On.

5.4.5.2 Çiva-M/I SPECIFIC telecommands

The selection of the Çiva-M/I scan characteristics is performed using the two parameters nb_step and chang_IR. The grating position after 3 sub-scans must correspond to the cut wavelength of the filter. By adjusting chang_IR, one can select from 192 to 240 grating positions before the filter change, and by adjusting nb_step, the last position can be adjusted to match the cut wavelength. By selecting values of chang_IR larger than 4, one can increase the number of grating positions after the filter change, hence recovering the design wavelength range if the step size is too small.

The selection of the integration time is performed as follows: the minimum integration time tmin is defined by the integration time field in word 24. It contains two sub-fields: t1 (bit 11) and t2 (bits 7-0). One MID time unit is 4.915 ms and the minimum or basic integration time is defined by $ti=4.915*(t1*7+1)*(t2+1)$. ti[0] is set as tmin. ti[1,2,3] are defined as tmin*2, tmin*5 and tmin*12. These integration times are converted into commands using t1=0 (multiplier=1) whenever possible. These four values can be shifted in log scale by changing the “int” command contained in words 27 (for subcycles 9, 10 and 11) or 28 (for subcycles 1, 2, 3, 4, 5, 6, 7 and 8). For each subscan n from 0 to 10 (subcycle n+1 from 1 to 11), two bits define the multiplying factor (1, 2, 5 or 12) to be applied to tmin in order to get the requested integration time. The default “int” parameters are: 2,0,1,1,0,0,1,3,3,2,2 (parameter field: 2BD052) leading to 5,1,2,2,1,1,2,12,12,5,5 multiplying factors to determine from tmin the integration time for each of the eleven successive subcycles.

Four acquisitions of the dark current with the lamp off, then with the lamp on and the filter off (eight images 128 x 96 in total) are performed for each of the four selected integration times (tmin * 1,2,5,12), before the scan begins. After the return scan, the filter is off, and four acquisitions are performed with the lamp on, then with the lamp off, for each of the four selected integration times (tmin * 1,2,5,12). The image corresponding to “lamp-on, filter off” with the same integration time before the beginning of the scan is subtracted from each image of the sub-scan if dark current subtraction is requested (sub_flag field in word 26).

ROSETTA LANDER ÇIVA & ROLIS IME	Acceptance Data Package	
RO-LRS-ADP-3304	Issue 2.1	Model: FM

5.4.6 ROLIS telecommands

ROLIS telecommands are validated at max. five levels:

1. CDMS message length validation (WRDC = number of received words)
2. ROLIS checksum validation [$\text{sum}(\text{telecommand words}) \text{ MOD } 65536 = 0$]
3. Telecommand repetition: repeated telecommands are ignored
4. Table of valid telecommand codes
5. Optional telecommand parameter checking

In most cases invalid telecommands are ignored without any notification. A few critical errors are notified with a ROLIS TEXT frame, containing an ASCII error message.

The ROLIS-FM software implements some basic hardware-oriented telecommands which are used to integrate and test the functionality of the ROLIS components. The following table gives an overview of the ROLIS-FM telecommands:

ROSETTA LANDER ÇIVA & ROLIS IME	Acceptance Data Package	
RO-LRS-ADP-3304	Issue 2.1	Model: FM

Table 5.4.6 : ROLIS telecommands

Code (hex)	Name	Parameters	Description	Remarks		
5000	LoadTcmd	ofs1 len1 ... ofsN lenN	Load N telecommands from the CDMS Stored Telecommand Buffer	Command loads N telecommands at address =ofsX and lenX>0 from the ROLIS-part of the Stored Telecommand Buffer of CDMS		
5001	DirectCH	cmd1 cmd2 ... cmdN	Raw output of N words to the ROLIS-D camera head	Command words are not validated if they make sense. Side effect: Switches ROLIS-D ON if necessary. Using this Tcmd one can obtain an full-frame image incl. the reference pixels		
5002	DirectMEM	img y x	DMA mode off	Setup a defined Memory Controller Address		
5003	DirectDMA	img y x	DMA Mode on	Setup DMA with a starting Memory Controller Address		
5004	PowerSwitch	flags	Output to the PowerSwitch Register		Flags are not verified. Pulses of 100 msec are generated by software. Attention!!! This telecommand changes ALL power switches at once !!! <i>It's safer to use telecommands 5006/ 5007 or 5008 instead.</i> <i>(cf. sect. 8.2.2)</i>	
			bit0	Rolis-D ON		static
			bit1	Civa-DPU ON		static
			bit2	Pan/MicHeat OFF		pulse
			bit3	Panorama Heat ON		pulse
bit4	MicroHeat ON	pulse				
5005	MotorEPS	img	Retrieve Motor End Position Switch (obsolete, see TestIFL-Pos)	One Motor-EPS word is written to img(x=0,y=0). Side effect: Switches ROLIS-D ON if necessary.		
5006	<i>PowerRolisD</i>	<i>flag</i>	<i>Switch RolisD on/ off</i>	<i>Flag= 0: Switch RolisD OFF</i> <i>preserving previous CivaDPU- andCivaHeaters status</i> <i>Flag= 1: Switch RolisD ON</i> <i>preserving previous CivaDPU- andCivaHeaters status</i>		
5007	<i>Power CivaDPU</i>	<i>flag</i>	<i>Switch CivaDPU on/ off</i>	<i>Flag= 0: Switch CivaDPU OFF</i> <i>preserving previous RolisD- and CivaHeaters status</i> <i>Flag= 1: Switch CivaDPU ON preserving previous power status</i> <i>preserving previous RolisD- and CivaHeaters status</i>		

Code (hex)	Name	Parameters	Description	Remarks
5008	PowerCivaHeat	flag	Switch CivaHeaters on/off	Flag=0: Switch both Civa-Heaters OFF preserving previous RolisD- andCivaDPU status Flag=1: Switch Panorama Heater ON preserving previous RolisD- andCivaDPU status Flag=2: Switch Microscope Heater ON preserving previous RolisD- andCivaDPU status
5010	MemPattern	img y x ny nx start incr	Fill an image memory area with a constant or incrementing pattern	The specified image area of $ny \times nx$ pixels is filled with a pattern. The starting pattern <i>start</i> is incremented after each pixel by <i>incr</i>
5011	MemData	img y x ny nx incr	Raw Image Data (skipping pixel)	Transmit a subimage, similar to MemData1 Produces TYPE=1 frames (cf. sect. 5.5.5).
5012	MemData1X	img mask [subimg] [subimg] ... [subimg] = [y x ny nx incr]	Raw Image Data (skipping pixel)	Max. 5 subimages can be dumped by one telecommand. <i>Mask</i> defines the pixel bits to be transmitted: $Mask=0FF0h \rightarrow 8$ bits/pixel. If $Pixelvalue > Mask$, transmit $Pixelvalue=Mask$. Every subimage is defined by the starting position (y,x) and the number of pixels to be transmitted (ny,nx). <i>Incr</i> defines the row and column offset (increment). If $incr=1$ then every pixel will be transmitted. If $incr=2$ then every second pixel in every second row, etc. The affected subimage is: (y,x) ... (y+ny-1, x+nx+1). Totally $(ny/incr * nx/incr)$ pixel values are transmitted per subimage.
5013	MemData2X	img mask [subimg] [subimg] ... [subimg] = [y x ny nx m]	Raw Image Data (Macropixel)	Macropixel version of MemData1X. For $m=1$ MemData2X is identical to MemData1X. For $m=3$ the makropixel size is 3 x 3, etc.
5014	MemData1A	img mask incr0 {ROI} {ROI} = {y x ny nx incr}	Raw Image Data with Region Of Interest (Skipping pixel)	Transmit the whole image with an optionally defined Region Of Interest (ROI). The ROI can be transmitted with a different (higher) resolution. <i>Incr</i> is the resolution for the ROI, <i>Incr0</i> for the remaining image.

ROSETTA LANDER ÇIVA & ROLIS IME		Acceptance Data Package	
RO-LRS-ADP-3304		Issue 2.1	Model: FM

Code (hex)	Name	Parameters	Description	Remarks
5015	MemData2A	img mask incr0 {ROI} {ROI} = {y x ny nx incr}	Raw Image Data with Region Of Interest (Macropixel)	Macropixel version of MemData1A.
5020	ConfigMem	framePage ztPage	Setup memory configuration	<p>ROLIS memory configuration (to be extended by more parameters). <i>framePage</i> (-3..+7) is the buffer for CDMS ROLIS+ÇIVA science data frames:</p> <p>a) <i>framePage</i> >= 0: MEM cube img buffer, 2 x 4096 frames = 2 x 1 MByte for ROLIS+ÇIVA</p> <p>b) <i>framePage</i> < 0: upper RolisDPU RAM pages 2 x 128 frames = 2 x 32 KByte for ROLIS+ÇIVA</p> <i>ztPage</i> (1..3) is the Upper-Memory page for ZeroTree calculations
5021	Config	flags	Set global ROLIS flags	Variable \$config (HK)
				bit15: =1: Enable text frame output
				bit14: =1: Flush text frame at end-of-line, (1: produce 1 line/frame; 0: multiple lines/frame (less data))
				bit13..1 2 =0..3 ROLIS diagnostic level; 0=off; 1=Tcmds/Tasks (standard / flight); 2=spare; 3=+imaging (max.) (cf. sect. 8.2.3).
				bit11: =1: Enable ÇIVA Interface diagnostic mode
				bit10: =1: Enable ÇIVA shift detection
				bit9: =1: Enable ÇIVA checksum verification
				bit7: =1: Enable touch-down detection by INT-4
				bit6: =1: Enable EEPROM save during descent
bit5: =1: Enable touch down signal from CDMS subsystem status				

Code (hex)	Name	Parameters	Description	Remarks
5022	ConfigCH	Usec {MotorDelay} {ExpDelay} {ReadoutTime} {HeatUpTime}	Set global ROLIS-CH configuration	uSec - 1 LSB of exposure time in microsec (EM=400, FM=3200) MotorDelay - Wait for IFL open/close in millisecc ExpDelay - Margin before/after image transmission in millisecc ReadOutTime - Transmission time for 1Kx1K pixels in millisecc HeatUpTime - Heatup time after Rolis-D power ON in millisecc
5023	ConfigAEC	LimitLo {LimitHi} {PercentLo} {PercentHi} {ExpMult} {X0} {Y0} {Step} {Count}	Set Auto-Exposure parameters	LimitLo - Underexposure limit (pixel values below are underexposed) LimitHi - Overexposure limit (pixel values above are overexposed) PercentLo - Max. rate of underexposed pixels for a good image (%) PercentHi - Max. rate of overexposed pixels for a good image (%) ExpMult - Exposure time multiplier/divider for under/overexposed img's X0, Y0 - Starting pixel for auto-exposure estimation Step, Count - Step, Count for auto-exposure estimation
5026	ConfigSave	<none>	Save configuration to EEPROM	The current configuration becomes the default and will be restored at the next power on. (cf. sect. 8.2.3).
5027	ConfigUnsave	<none>	Unsave default configuration from EEPROM	Reset the current configuration to the default.
5028	ExecCode	code code ...	Execute short (<=30 words) code	Compiled machine <i>code</i> should finish with a RETURN statement
5029	LoadRAM	page adr data data ...	Load code/data into RAM page	Upload <i>data</i> into RAM <i>page:adr</i>
502A	DumpRAM	page adr len	Dump code/data from RAM	Dump min. <i>len</i> bytes from RAM page to TYPE=14 frames (cf. sect. 5.5.5). Frames are filled up.
502B	CopyRAM	page1 adr1 page2 adr2 size	Copy code/data from/to RAM	Copy <i>size</i> data words from <i>page1:adr1</i> to <i>page2:adr2</i>
502C	FillRAM	page adr times pat1 ... patN	Fill RAM with repeated pattern	Fill RAM at <i>page:adr</i> with <i>pattern=(pat1...patN)</i> , repeat <i>times</i>

Code (hex)	Name	Parameters	Description	Remarks
502D	BurnEEPROM	eadr page adr size {chksum}	Burn EEPROM, optionally after checksum validation	Burn <i>size</i> words from <i>page:adr</i> to EEPROM <i>eadr</i> If <i>chksum</i> is specified, it must match $chksum = - \text{Sum}(\text{size words}) \% 65536$
502E	BootRAM	page adr size	Boot code from RAM	Boot code from <i>page:adr</i>
502F	BootEEPROM	eadr	Boot code from EEPROM	Boot from EEPROM <i>eadr</i> after checksum validation
5030	Wavelet1	img	Wavelet transformation (5,3 wavelet)	Wavelet transformation (6 steps) producing 16x16 tiles á 64x64 pixels; destination: img (img=0..7)
5031	Compress1	img rate tile1 tile2 {ROI} {ROI} = {rate tile1 tile2}	ZeroTree coding / compression	ZeroTree Coding in 64x64 tiles: img=0..7, compression rate=0..15, tile=0..255. ROI – Region of interest with parameters {rate tile1 tile2} different from the other part of image [cf. sect. 5.5.6]
5041	ImgIFL	ifl	Open/Close Infinity Lense (IFL)	ifl: bit9 ... bit8 = 1:close, 2:open bit7 ... bit0 = N; Number of retrials <i>Side effect: Switches ROLIS-D ON if necessary.</i>
5042	ImgLedWarmup	led	Switch on LED for warmup	led: bit15 = 1: Enable LED, 0:No LED bit9 ... bit8 = 0:RED, 1:GREEN, 2:BLUE, 3:IR bit7 ... bit0 = warmup duration in seconds <i>Side effect: Switches ROLIS-D ON if necessary.</i>
5043	ImgExpose	img expTime led	Exposure and data transfer	img = 0..7 image buffer expTime= 1...32767, 1 LSB of exposure time = 3.2 ms for FM (EM=0.4 ms) = -1....-32767, auto-exposure startup value led = same as for ImgLedWarmup <i>Side effect: Switches ROLIS-D ON if necessary.</i>
5048	ImgCopy	imgFrom imgTo	Copy Image	Copy the whole image from imgFrom (0..7) to imgTo (0..7)
5049	ImgSubstract	img1 img2	Substract img2 from img1	img1,img2 = 0..7 Substract a dark image (img2) from img1: $img1 = img1 - img2$
504A	ImgFilter	img filter	Run a filter over the image	img: = 0..7 filter: bit15 ... bit12 = 0:No filter, <>0: Type of filter bit11 ... bit0 = Filter parameter (max. 12 bits)

Code (hex)	Name	Parameters	Description	Remarks
504B	ImgSendISB		Send Image Status Block	Output of the ISB for all 8 images as a science data frame TYPE=3 (cf. sect. 5.5.5).
504C	ImgShift	img num	Shift image by num bits	img=0..7, num=1..14
5051	SingleImg (“CloseupImg”)	img ifl expTime led dark filter {rate tile1 tile2 {ROI}}	imaging macro for Closeup-imaging (CUC- and CUS-modes) and also for first descent mode (DIT)	img: image number = 0..7 ifl: see ImgIFL bit9..bit8 = 1:close after exposure, 2:open before exposure, 3:both bit7 ... bit0 = N; Number of retrials expTime: see ImgExpose led: see ImgLedWarmup dark: bit9 ... bit8 = 8: Take new dark image, 4:Use existing dark image bit2 ... bit0 = dark image buffer = 0..7 filter: see ImgFilter rate tile1 tile2 {ROI} optional , see Compress1, if not specified then no wavelet compression! <i>Side effect: Switches ROLIS-D ON if necessary.</i>
5053	DescentBuffer	bufA cntA bufB cntB bufC1 ... bufCN	Setup buffers for descent imaging	bufA, cntA: Image buffer for long-term image, taken after cntA bufC loops bufB, cntB: Image buffer for mid-term image, taken after cntB bufC loops bufC1...bufCN: Image loop buffer, max. N=6 buffers
5054	DescentImgC	expTime delay filter {rate tile1 tile2 {ROI}}	imaging macro for the second mode of Descent imaging (DIS): Run imaging, ring-buffer, data compression, compressed data output to CDMS	expTime= 1...32767, 1 LSB of exposure time = 3.2 ms for FM (EM=0.4 ms) ; NO auto-exposure possible! delay: delay time in ms filter: see ImgFilter rate tile1 tile2 {ROI} optional, same as Compress1, if not specified then NO data output (testing only) !!! <i>Side effect: Switches ROLIS-D ON if necessary.</i>

Code (hex)	Name	Parameters	Description	Remarks
5055	DescentImgR	expTime delay filter {mask incr0 {ROI}}	imaging macro for the second mode of Descent imaging (DIS)with raw data output (macropixel)	expTime: see DescentImgC delay: see DescentImgC filter: see ImgFilter mask incr0 {ROI} optional, same as MemData2A, if not specified then NO data output (testing only) !!! <i>Side effect: Switches ROLIS-D ON if necessary. After receiving any STOP signal (Touch-down signal, message from CDMS, or DescentStop telecommand) ROLIS-D is switched OFF.</i>
5857	DescentStop	<none>	Stop descent imaging immediately	IMMEDIATE telecommand flag necessary !!! <i>Can be used to timeout descent imaging. (cf. sect. 8.2.4).</i>
5058	DescentCheckC	rate tile1 tile2 {ROI}	Check Descent mode after landing	Checks for unfinished descent imaging, then transmit bufA, bufB rate tile1 tile2 {ROI} same as Compress1
5059	DescentCheckR	mask incr0 {ROI}	Check Descent mode after landing	Checks for unfinished descent imaging, then transmit bufA, bufB mask incr0 {ROI} same as MemData2A
5060	DarkRef	img expTime	Dark reference image	Take a dark reference image (full frame 1066 x 1064 pixels). Extract the dark reference currents. Produces one ISB science data frame TYPE=3 and 9 dark reference frames TYPE=4 (cf. sect. 5.5.5)
5061	Full Image	img expTime	Extracts from a „full-frame-image“ the 1024 x 1024 image data <u>without</u> data-transfer to CDMS	Attention! Overwrites also the next img (=img+1); Tcmd will be denied if img+1 is the ROLIS/CIVA-output buffer to CDMS; <i>Afterwards the data transfer is possible by using the Tcmds 5011, or 5031.</i>
50E0	WaitDataComplete	pollintervall	Wait until Rolis/Civa activity (incl. transfer to CDMS) is finished, then send OCPL service request code to CDMS	Wait until all buffered data sent from ROLIS & CIVA; send OCPL service request code to CDMS for conditional actions (Tcmds, power off); (cf. sect. 8.2.5). Condition for “data activity finished”: 1. No ROLIS/CIVA data in the RolisIME buffer 2. No new ROLIS/CIVA data produced within the last pollinterval pollinterval in sec (>0)
50F0	Sleep	sec	Sleep sec seconds	May be used to wait for completion of some background operation (e.g. DMA)

Code (hex)	Name	Parameters	Description	Remarks
50F1	TestMem	<none> img hv mask	Perform image memory test	3 different test modes & parameters: <none> - Complete test, 4 test x 8 images (~ 12 minutes) img - 4 tests x 1 image (~1.5 minutes) hv mask - 1 test x 8 images (3 minutes) hv=0:horizontal, 1:vertical Produces one test data frame (TYPE=15, SUBTYPE=1, 5F01) (cf. sect. 5.5.5).
50F2	TestImg	img expTime led {img expTime led}	Make test image(s), image histogram / difference image	If called with img parameter, then the histogram of the image is calculated. With two img parameters, the histogram of the difference image is calculated. The second form is useful for CH-interface tests with the CH-simulator. Produces one test data frame (TYPE=15, SUBTYPE=2, 5F02) (cf. sect. 5.5.5)..
50F3	TestIFL-Pos	<none>	Retrieve IFL position switch	Produces one test data frame (TYPE=15, SUBTYPE=3, 5F03) (cf. sect. 5.5.5)..
50F8	TcmdLog		Dump telecommand log	Produces 1 science data frame (TYPE=13) (cf. sect. 5.5.5).
50FF	Noop	<none>	Do nothing	Valid telecommand without operation

ROSETTA LANDER ÇIVA & ROLIS IME	Acceptance Data Package	
RO-LRS-ADP-3304	Issue 2.1	Model: FM

5.5 LIST OF TELEMETRY PACKETS (SCIENCE AND H/K)

5.5.1 ROLIS / ÇIVA housekeeping data (HK) - overview

The ROLIS-DPU can operate in two different modes and produce different sets of housekeeping data:

- ComDPU mode: after power on, 4 x 32 HK values per frame
- ROLIS mode: after booting the ROLIS software, 2 x 64 HK values per frame (2 Rolis/Civa HK blocks)

It is obvious that the housekeeping data transmitted during the ComDPU mode cannot be identical to those transmitted during the ROLIS mode. There is, however, a common part in both modes: the so-called Analog-HK. These are the 16 multiplexed channels (A/D values) which can be used as 'hardware health parameters' (emphasized in the table 5.5.1-1 below, and outlined in table 5.5.2-1). The other housekeeping data is the software-HK (or shortly Soft-HK).

ROLIS / ÇIVA uses 64 different HK values for Health Status report packets. Therefore a complete HK block is generated every approx. 128 seconds (fast CDMS HK mode). Four HK blocks are transmitted during one CDMS HK cycle (256 words, 512 seconds).

The DPU mode can be identified by HK channel 16 which has the value 0xDEB0 or 0xBEEF respectively (cf. Tab. 5.5.1-1). The 16 Analog-HK is independent of the mode; but the Soft-HK cannot be clearly interpreted during the transition between ComDPU and ROLIS modes (mixed HK values) ! In the normal ROLIS mode the first Rolis/Civa HK block describes the status of **256 seconds before** the fixed OBT and the second HK block the status of **128 seconds before** this OBT. For timing details see Sect. 8.2.8 and 8.2.9!

Table 5.5.1-1 : ROLIS / ÇIVA HK allocation table (Health Status report packet)

HK word	ComDPU HK data		ROLIS / ÇIVA HK data	
	Description	Hex range	Description	Hex range
0..15	A/D values	0000..1FFF	A/D values	0000..1FFF
16	ComDPU HK identifier	=DEB0	ROLIS-HK identifier	=BEEF
17..31	ComDPU system variables	0000..FFFF	ROLIS-DPU system variables	0000..FFFF
32..47	A/D values	0000..1FFF	ROLIS Software HK	0000..FFFF
48	ComDPU HK identifier	=DEB0	ÇIVA Software HK	0000..FFFF
49-63	ComDPU system variables	0000..FFFF		

ROSETTA LANDER ÇIVA & ROLIS IME		Acceptance Data Package	
RO-LRS-ADP-3304		Issue 2.1	Model: FM

5.5.2 Description of ROLIS / ÇIVA housekeeping data

Table 5.5.2-1 : First 16 HK words, representing the A/D values in the ComDPU and ROLIS modes

HK word No.	AMUX line	Name	Physical		Description
			value	unit	
HK#0	INR1	TRD	100/0.75*3*X/8192-273.15 (1)	°C	temperature of ROLIS-D
HK#1	INR2	TSC1	100*X/8192-50 (2) 100*X/8192-50+(ΔHK#14)*2.8/0.35 (3)	°C	temperature of ÇIVA-P1
HK#2	INR3	TSC2	100*X/8192-50 (2) 100*X/8192-50+(ΔHK#14)*2.8/0.35 (3)	°C	temperature of ÇIVA-P2
HK#3	INR4	TSC3	100*X/8192-50 (2) 100*X/8192-50+(ΔHK#14)*2.8/0.35 (3)	°C	temperature of ÇIVA-P3
HK#4	INR5	TSC4	100*X/8192-50 (2) 100*X/8192-50+(ΔHK#14)*2.8/0.35 (3)	°C	temperature of ÇIVA-P4
HK#5	INR6	TSC5	100*X/8192-50 (2) 100*X/8192-50+(ΔHK#14)*2.8/0.35 (3)	°C	temperature of ÇIVA-P5
HK#6	INR7	TSC6	100*X/8192-50 (2) 100*X/8192-50+(ΔHK#14)*2.8/0.35 (3)	°C	temperature of ÇIVA-P6
HK#7	INR8	TSC8	100*X/8192-50 (2) 100*X/8192-50+(ΔHK#14)*2.8/0.33 (3)	°C	temperature of ÇIVA-M/V detector
HK#8	INR9	TSC9	100*X/8192-50 (2) 100*X/8192-50+(ΔHK#14)*2.8/0.28 (3)	°C	temperature of ÇIVA-M/I mechanism
HK#9	INR10	TSC10	100*X/8192-50 (2) 100*X/8192-50+(ΔHK#14)*2.8/0.28 (3)	°C	temperature of ÇIVA-M/I optics
HK#10	INR11	TSC11	100*X/8192-50 (2) 100*X/8192-50+(ΔHK#14)*2.8/0.33 (3)	°C	temperature of ÇIVA-M/V optics
HK#11	INR12	U15P_D	(1+40.2/8.25)*3*X/8192	V	voltage of D+15V power line if RolisD on
HK#12	INR13	U5N_D	2.0*3*X/8192	V	voltage of D-5V power line if RolisD on
HK#13	INR14	U5P_D	2.0*3*X/8192	V	voltage of D+5.2V power line if RolisD on
HK#14	INR15	HKI+5.2V	1.2*0.5*2.0*3*X/8192	A	current of +5.2V power line, consumed by ÇIVA / ROLIS / IME
HK#15	INR16	U5P_A	2.03*3*X/8192	V	voltage of A+5V power line of RolisDPU

¹ X = -8192 ... +8191; (±13bit)

² Valid transfer function when ROLIS On only (HK#14 value ≤ 0.5 A)

³ Valid transfer function when ROLIS+ÇIVA On together (HK#14 value > 0.5 A), ΔHK#14 being the extra current due to ÇIVA (difference between the HK#14 value when ROLIS is On only and the HK#14 value when both ROLIS and ÇIVA are On together)

ROSETTA LANDER ÇIVA & ROLIS IME	Acceptance Data Package
RO-LRS-ADP-3304	Issue 2.1
	Model: FM

Table 5.5.2-2 : Housekeeping values (HK#16 ...#31) in the ComDPU mode

HK word No.	Name	Bits	Value	Description
HK#16	hkIdent	16	0xDEB0	ComDPU HK identifier
HK#17/18	time	32		ComDPU time after boot in milliseconds (hi,lo), max ~ 49 days
HK#19/20	cdmsTime	32		Last received CDMS lander onboard time (lo,hi)
HK#21	statMsg	16		Counter of received CDMS STAT messages
HK#22	cmdMsg	16		Counter of received CDMS CMD messages
HK#23	datMsg	16		Counter of received CDMS DATA messages
HK#24	savMsg	16		Counter of CDMS messages saved to ComDPU ring buffer
HK#25	debMsg	16		Counter of received DEBx telecommands
HK#26	srErrCount	16		Service Request error counter
HK#27	fileStat	16	-1..+2	File Upload status: -1=error, 0=none, +1=running, +2=ready
HK#28	filePtr	16		File upload address pointer
HK#29	fileCount	16		File upload word counter Advanced upload: telecommand checksum error counter
HK#30/31	hkFree	2x16	0xDEAD	placeholder

Table 5.5.2-3 : Housekeeping values (HK#16 ...#63) in the ROLIS mode

HK word No.	name (EGSE S/W)	variables (Rolis S/W)	bits	value	Description
HK#16	Ident	hkIdent	16	0xBEEF	RolisDPU HK identifier
HK#17/18	Time	time	32		RolisDPU time after boot in milliseconds (32-bit value hi,lo), max ~ 49 days
HK#19	CdmsMode	cdmsMode	8		Higher 8 bits of CDMS RMOD message
		cdmsOBT.hi	8		Higher 5 bits of LOBT from RSST message
HK#20/21	CdmsOBT	cdmsOBT	32		Last received LOBT from RTIM message (32-bit value lo,hi) 1 LSB = 31.25 ms
HK#22	CdmsSST	cdmsSST	16		CDMS Service System Status: 1 st word of RSST message
HK#23	StatMsg	statMsg	16		Counter of received CDMS STAT messages
HK#24	CmdMsg	tcmdMsg	16		Counter of received CDMS telecommand messages (RCMD, RCMS)
HK#25	DatMsg	dataMsg	16		Counter of received CDMS science data messages (TSCR)
HK#26	SavMsg	savMsg	16		Counter of CDMS messages saved to ROLIS message ring buffer (RTM-, TCMD-, HK#63-messages) to inform Civa
HK#27	ErrSR	srErrCount	16		Service Request error counter (CDMS error message)
HK#28	ErrTcmd	tcmdErr	8		ROLIS telecommand error counter (wrong CS or unknown Tcmd)
	RolisTcmd	tcmdRolis	8		ROLIS valid telecommand counter
HK#29	CivaTcmd	tcmdCiva	16		ÇIVA telecommand counter
HK#30	CivaMsg	cifMsg	16		ÇIVA interface message counter

ROSETTA LANDER ÇIVA & ROLIS IME		Acceptance Data Package	
RO-LRS-ADP-3304	Issue 2.1	Model: FM	

HK word No.	name (EGSE S/W)	variables (Rolis S/W)	bits	value	Description
HK#31	CivaShift	cifShift	4	0..15	ÇIVA interface shift value
	CivaClock	cifClock	4	0..3	ÇIVA interface clock: 1=78 kHz, 2=39 kHz, 3=error+39 kHz; 0=not used
	CivaErr	cifErrCnt	8	0..255	ÇIVA interface error counter (during CivaDPU booting some errors are usual)
HK#32	Config	config	16		ROLIS configuration flags (see telecommand 5021=Config)
HK#33	Flags0	flags0	16		0x8000: ROLIS-D DMA active 0x4000: ÇIVA switched ON 0x2000: ROLIS-D switched ON 0x0008: Descent imaging active 0x0004: Descent imaging stopped by CDMS RSST message 0x0002: Descent imaging stopped by touch-down signal (INT-4) 0x0001: Descent imaging stopped by telecommand
HK#34	iflPos	iflPos	8	1..3	infinity lense position: 1=open, 2=close, 3=middle
	PowerStat	powerStat	8		Power switch status (see telecommand 5004=PowerSwitch)
HK#35	FramePage	framePage	8	-3..+7	Memory page for CDMS frame output (see telecommand 5020=ConfigMEM)
	ZtPage	ztPage	8	1..3	Memory page for zero-tree algorithm (see telecommand 5020=ConfigMEM)
HK#36	frStatRolis	frStatRolis	8		Number of frames in ROLIS buffer (upper 8 bits [∇])
	frStatCiva	frStatCiva	8		Number of frames in ÇIVA buffer (upper 8 bits)
HK#37	frCountRolis	frCountRolis	16		Total ROLIS output frame counter
HK#38	frCountCiva	frCountCiva	16		Total ÇIVA output frame counter
HK#39	CifFrames	cifFrameCount	16		Total ÇIVA input frame counter (ÇIVA interface DATA messages)
HK#40	TaskFlags	taskFlags	8	0..15	internal ROLIS multitasking status: Bits7-4: stack overrun for task3-0 Bits3-0: active flag for task3-0
	TaskActive	taskActive	8	0..3	internal ROLIS multitasking status: currently active task
HK#41/44	TaskSPR	taskStackPtr	4x16		internal ROLIS multitasking status: stackpointer for tasks 0..3
HK#45	CifMsgBufOvr	cifMsgBufOvr	8	0..255	ÇIVA message buffer overrun counter
	CifTcmdErr	cifTcmdErr	8	0..255	ÇIVA telecommand checksum error counter
HK#46	CifTcmdCount	cifTcmdCount	16		ÇIVA telecommand output counter (sent to ÇIVA)
HK#47	Free ⁴	hkFree	16	"R"	ROLIS HK placeholder with ascii "R" (hex 52)
HK#48/63	Civa0 Civa1 Civa2 Civa3	hkCiva	16x 16	"C"	ÇIVA HK data or filled with ascii "C" (hex 43), if CivaDPU was not powered on before

[∇] a) framePage > 0 => ImgBuffer (MEM cube img buffer) á 4095 frames (= 1MB Rolis + 1MB Civa) => 16 * frStat

b) framePage < 0 => MemPage (RolisDPU RAM page) á 255 frames (= 32kB Rolis + 32kB Civa) => 1 * frStat

ROSETTA LANDER ÇIVA & ROLIS IME	Acceptance Data Package	
RO-LRS-ADP-3304	Issue 2.1	Model: FM

5.5.3 ComDPU messages (science data)

The tables below explains all success and error messages issued by the Debug-Monitor. These messages are in plain ASCII. They are sent as a CDMS science data frame (1 frame per message). All frames start with the string :

- “ComDPU: “ (hex: 436F 6D44 5055 3A20)

followed by an error message (nn is a two-digit error code) :

- “Enn-...”

or by a success message :

- “Mnn-...”.

A ComDPU message frame can optionally be followed by one or more raw data frames (DEB8 telecommand, ref. Section 5.4.4.2)

Table 5.5.3 : ComDPU messages

Message	Command(s)	Description
Error messages		
E01-Invalid command: CMD	DEBE, DEBF, EEPROM on LM	Undefined DEBx command received (CMD) Or no EEPROM support on LM
E02-Checksum error: SUM	all commands (via CDMS only)	Command with checksum error received. SUM = DEBx + parameters + checksum <> 0
E03-Too much data	DEB1: File Data	More data received than specified in DEB0: File Upload
E04-File upload error	DEB2: File End	Issued after errors E02 or E03 during file upload
E05-File length error: COUNT	DEB2: File End	Less data received than specified in DEB0: File Upload COUNT= number of missing words
E06-Filesum error: SUM	DEB2: File End	File checksum error. SUM = filedata(i) + checksum <> 0
E07-Exec: No file uploaded	DEB4: Execute File	No file has previously been uploaded
E08-Exec: Can exec code only at page=0	DEB4: Execute File	File must be uploaded to page 0 to be executed
E09-ExecCode: No code	DEB6: Execute Code	No code specified in command
E10-Fill RAM: Missing parameters	DEB9: Fill RAM	Missing parameters for FILL RAM command
E11-EEPROM: No file uploaded	DEB3: Burn EEPROM File	No file has previously been uploaded
E12-Checksum error SUM (eAdr, eLen) = ADR LEN	Boot EEPROM File or during automatic boot	EEPROM checksum error, but nevertheless trying to boot from specified EEPROM location
Success messages		
M01-File upload successful: (page,adr,len) = PAGE ADR LEN"	DEB2: File End	File upload has been successful to specified location
M02-Exec: adr=ADR	DEB4: Execute File	Message issued ≈1 sec before executing code at ADR
M03-Move RAM: PARAMS	DEBA: Move RAM	Message issued ≈1 sec before moving memory
M04-Sum(PAGE ADR LEN) = SUM	DEBB: RAM Checksum	The RAM checksum is
M05-Exec code: CODE	DEB6: Execute Code	Message issued ≈1 sec before executing the CODE
M06-Fill: PARAMS	DEB9: Fill RAM	Message issued ≈1 sec before filling memory
M07- Dump: PARAMS	DEB8: Dump RAM	Starting message before dumped data
M08-Boot RAM: PARAMS	DEBC	Message issued ≈1 sec before booting from specified RAM location
M09-EEPROM File: (page,adr,len,checksum) =	DEB3: Burn EEPROM File	Message issued ≈1 sec before burning uploaded file to EEPROM

ROSETTA LANDER ÇIVA & ROLIS IME	Acceptance Data Package	
RO-LRS-ADP-3304	Issue 2.1	Model: FM

Message	Command(s)	Description
M10-EEPROM File: Ready	DEB3: Burn EEPROM File	Message issued after successfully burning EEPROM
M11-EEPROM Write: PARAMS	DEB5: Write EEPROM	Message issued \approx 1 sec before writing memory to EEPROM
M12-EEPROM Write: Ready	DEB5: Write EEPROM	Message issued after successfully writing EEPROM
M13-EEPROM read: PARAMS	DEB7: Read EEPROM	Message issued \approx 1 sec before reading from EEPROM
M14-Boot EEPROM: PARAMS	DEBD: Boot EEPROM File	Message issued \approx 1 sec before booting from EEPROM
M15-Timeout, Boot RAM 1:0000	LM only	DEBx monitor timeout (1 min), start booting from RAM page 1 in \approx 1 sec
M16-Boot EEPROM: 0000	not for LM	DEBx monitor timeout (1 min), start booting from EEPROM address 0 in \approx 1 sec

5.5.4 ROLIS / ÇIVA science data frames

ROLIS and ÇIVA science data are packed into science data frames of 128 words. The first word defines the data source (ROLIS or ÇIVA) and the frame type (cf. table 5.5.4).

Table 5.5.4 : General data frame structure

Source	Word number	Bits	Field	Value	Description
ÇIVA (Cxxx)	1.word	bit15..12	CIVA-ID	=0Ch =12	ÇIVA sc. data identifier
	2.-128.word	bit11..0	CIVA-DAT		ÇIVA science data
ROLIS (Sxxx)	1.word	bit15..12	ROLIS-ID	=5	ROLIS sc. data identifier
		bit11..8	TYPE		ROLIS frame type
		bit7..0	SUBTYPE		ROLIS frame subtype
	2.word	bit15..0	TCOUNT		ROLIS frame counter since power-on-reset (separate for each frame TYPE)
	3.-128.word		ROLIS-DAT		ROLIS data (content depends on frame TYPE)

ROSETTA LANDER ÇIVA & ROLIS IME	Acceptance Data Package	
RO-LRS-ADP-3304	Issue 2.1	Model: FM

5.5.5 ROLIS science data frames classification

The following tables give a brief overview of the different TYPEs of ROLIS science data frames.

Frames are received as arrays of 16-bit words in little-endian byte order (low, high).

Therefore we define the data position within a frame as words:bits.

Table 5.5.5-1 : ROLIS ascii text frame (TYPE=0)

	Offset words:bits	Size	Field	Value	Description
ROLIS					
	0:0	4 Bits	ROLIS-ID	=5	ROLIS science data identification
	0:4	4 Bits	TYPE	=0	ROLIS frame type
	0:8	8 Bits	SUBTYPE	=0	
	1:0	16 Bits	TCOUNT	=0..65535	ROLIS frame counter for TYPE=1
	2:0	252 Bytes	TEXT		Plain ASCII text

Table 5.5.5-2 : ROLIS raw image data - skipping pixels (TYPE=1)

	Offset words:bits	Size	Field	Value	Description
ROLIS					
	0:0	4 Bits	ROLIS-ID	=5	ROLIS science data identification
	0:4	4 Bits	TYPE	=1	ROLIS frame type
	0:8	8 Bits	SUBTYPE	=0..3	0: continued data frame, 1: first frame, 2: last frame, 3: single frame
	1:0	16 Bits	TCOUNT	=0..65535	ROLIS frame counter for TYPE=1
SUBTYPE=1,3					Format of first raw image frame
	2:0	16 Bits	IMAGE	=0..7	Image number
	3:0	16 Bits	MASK	=0000h..FFFFh	Pixel mask, only masked bits of each pixel are transmitted
	4:0	16 Bits	Y	=0..1023	Starting row
	5:0	16 Bits	X	=0..1023	Starting column
	6:0	16 Bits	NY	=1..1024	Number of dumped rows
	7:0	16 Bits	NX	=1..1024	Number of dumped columns
	8:0	16 Bits	INCR	=0..1024	Row/Column increment
	9:0	238 Bytes	RAW		Raw pixel data, n bits per pixel, n=number of 1's in MASK
Subtype=0,2					Format of continued frames

ROSETTA LANDER ÇIVA & ROLIS IME		Acceptance Data Package	
RO-LRS-ADP-3304		Issue 2.1	Model: FM

Offset words:bits	Size	Field	Value	Description
2:0	252 Bytes	RAW		Raw pixel data, n bits per pixel, n=number of 1's in MASK

Table 5.5.5-3 : ROLIS raw image data - macropixels (TYPE=2)

Offset words:bits	Size	Field	Value	Description
ROLIS				
0:0	4 Bits	ROLIS-ID	=5	ROLIS science data identification
0:4	4 Bits	TYPE	=2	ROLIS frame type
0:8	8 Bits	SUBTYPE	=0..3	0: continued data frame, 1: first frame, 2: last frame, 3: single frame
1:0	16 Bits	TCOUNT	=0..65535	ROLIS frame counter for TYPE=2
SUBTYPE=1,3				
Format of first raw image frame				
2:0	16 Bits	IMAGE	=0..7	Image number
3:0	16 Bits	MASK	=0000h..FFFFh	Pixel mask, only masked bits of each pixel are transmitted
4:0	16 Bits	Y	=0..1023	Starting row
5:0	16 Bits	X	=0..1023	Starting column
6:0	16 Bits	NY	=1..1024	Number of dumped rows
7:0	16 Bits	NX	=1..1024	Number of dumped columns
8:0	16 Bits	M	=0..1024	Macro pixel size MxM
9:0	238 Bytes	RAW		Raw pixel data, n bits per pixel, n=number of 1's in MASK
SUBTYPE=0,2				
Format of continued frames				
2:0	252 Bytes	RAW		Raw pixel data, n bits per pixel, n=number of 1's in MASK

Table 5.5.5-4 : ROLIS Image Status Block (ISB) frame (TYPE=3)

Offset words:bits	Size	Field	Value	Description
ROLIS				
0:0	4 Bits	ROLIS-ID	=5	ROLIS science data identification
0:4	4 Bits	TYPE	=3	ROLIS frame type
0:8	8 Bits	SUBTYPE	=0	
1:0	16 Bits	TCOUNT	=0..65535	ROLIS frame counter for TYPE=3
2:0	4 Bytes	ISB.ID	=”ISB-“	
4:0	4 Bytes	ISB.Magic		Magic code stored in EEPROM (e.g. during descent phase = “DESC”)

ROSETTA LANDER ÇIVA & ROLIS IME	Acceptance Data Package
RO-LRS-ADP-3304	Issue 2.1 Model: FM

Offset words:bits	Size	Field	Value	Description
6:0	1 Byte	ISB.BufA	=0..7	Image buffer A used for descent
6:8	1 Byte	ISB.BufB	=0..7	Image buffer B used for descent
7:0	2 Bytes	ISB.Free	=0	Placeholder
8:0	240 Bytes	ISB		Image Status Block for 8 image buffers = 8 x 30 Bytes, see below

Table 5.5.5-5 : Image Status Block (ISB) contents

Offset words:bits	Size	Field	Value	Description
0:0	1 Byte	ISB.BufNo	=0..7	Image buffer number for the current ISB
0:8	1 Byte	ISB.Flags		Image buffer flags: key-words: 01h: Exposed: Image has been exposed 02h: DIS: Image is a valid DIS-mode image 04h: Wavelet: Image is wavelet transformed 08h: DarkSubtracted: Dark image has been subtracted 10h: Full: img used for internal full image transfer from CH 20h: Transmitted: Image has been transmitted to CDMS 40h: unused 80h: Blocked: Image blocked for other use (ROLIS/CIVA-output buffer to CDMS)
1:0	4 Bytes	ISB.RTime		Rolis time
3:0	6 Bytes	ISB.LOBT		Lander onboard time (lander format)
6:0	1 Word	ISB.ExpTime	=0..32767	Image Exposure Time, 1 LSB = 3.2 ms (FM/FS) or 0.4ms (EM/PFM)
7:0	1 Word	ISB.LED		LED parameter used for exposure (see telecommand ImgExpose)
8:0	1 Byte	ISB.IFL-Pos	0..3	IFL position before exposure (1=open, 2=close, 3=both)
8:8	1 Byte	ISB.Free1	=0	Unused (placeholder)
9:0	1 Word	ISB.Avrg	=0..16383	Image average pixel value
10:0	1 Word	ISB.DMA-Err	=0..1024	DMA error counter (number of unwritten lines)
11:0	1 Word	ISB.CH-Temp	=-8192..+8191	Rolis-D CH temperature before exposure;
12:0	1 Word	ISB.Filter	=0	Applied image filter (still unused)
13:0	1 Word	ISB.ErrCode	=0	Additional imaging error codes (unused)
14:0	1 Word	ISB.Free2	=0	Placeholder (unused)

ROSETTA LANDER ÇIVA & ROLIS IME	Acceptance Data Package
RO-LRS-ADP-3304	Issue 2.1 Model: FM

Table 5.5.5-6 : ROLIS Dark Reference frame (TYPE=4)

Offset words:bits	Size	Field	Value	Description
ROLIS				
0:0	4 Bits	ROLIS-ID	=5	ROLIS science data identification
0:4	4 Bits	TYPE	=4	ROLIS frame type
0:8	8 Bits	SUBTYPE	=0	
1:0	16 Bits	TCOUNT	=0..65535	ROLIS frame counter for TYPE=4
2:0	16 Bits	ROW	=0..1065	Starting row for this frame
3:0	16 Bits	EXP	=0..32767	Exposure time
4:0	124 words	DATA	= 0..16383	124 median dark reference values for each row

Table 5.5.5-7 : ROLIS wavelet compressed image (TYPE=8)

Offset words:bits	Size	Field	Value	Description
ROLIS				
0:0	4 Bits	ROLIS-ID	=5	ROLIS science data identification
0:4	4 Bits	TYPE	=8	ROLIS frame type
SUBTYPE				
0:8	4 Bits	RATE	=0..15	Compression rate, defining (M,N): M tiles per N frames
0:12	4 Bits	FCOUNT	=0..N-1	
1:0	16 Bits	TCOUNT	=0..65535	ROLIS frame counter for TYPE=8
2:0	252 Bytes	TILE-DATA		Compressed tile data, M tiles in N frames, each tile = 252*N/M bytes

Details regarding the ROLIS image compression see section 5.5.6

Table 5.5.5-8 : ROLIS telecommand log (TYPE=13)

Offset words:bits	Size	Field	Value	Description
ROLIS				
0:0	4 Bits	ROLIS-ID	=5	ROLIS science data identification
0:4	4 Bits	TYPE	=13	ROLIS frame type
0:8	8 Bits	SUBTYPE	=00..FF	= current index in telecommand log ring buffer
1:0	16 Bits	TCOUNT	=0..65535	ROLIS frame counter for TYPE=13

ROSETTA LANDER ÇIVA & ROLIS IME		Acceptance Data Package	
RO-LRS-ADP-3304		Issue 2.1	Model: FM

Offset words:bits	Size	Field	Value	Description
2:0	126 words	TELECMD		Telecommand data

Table 5.5.5-9 : ROLIS memory page dump (TYPE=14)

Offset words:bits	Size	Field	Value	Description
ROLIS				
0:0	4 Bits	ROLIS-ID	=5	ROLIS science data identification
0:4	4 Bits	TYPE	=14	ROLIS frame type
0:8	8 Bits	SUBTYPE	=0..8	RAM-page
1:0	16 Bits	TCOUNT	=0..65535	ROLIS frame counter for TYPE=14
2:0	16 Bits	ADR	=0000h..FFFFh	RAM page address
3:0	125 words	DATA		Dumped data words

Table 5.5.5-10 : ROLIS test frame (TYPE=15)

Offset words:bits	Size	Field	Value	Description
ROLIS				
0:0	4 Bits	ROLIS-ID	=5	ROLIS science data identification
0:4	4 Bits	TYPE	=15	ROLIS frame type
0:8	8 Bits	SUBTYPE	=1..3	0: continued data frame, 1: first frame, 2: last frame, 3: single frame
1:0	16 Bits	TCOUNT	=0..65535	ROLIS frame counter for TYPE=15
SUBTYPE=1				ROLIS memory test frame
2:0	3N words	TEST-REC's		Pixels are written with changing patterns and then verified
	4 Bits	IMG	=0..7	Tested image buffer
	12 Bits	ERR-COUNT	=0..4095	Error counter, number of wrong pixels
	16 Bits	WRITTEN		Nominal written pattern (last error)
	16 Bits	READ		Current read value (last error)
3N+2:0	126-3N words	FILL	=FFFFh	Frame is filled with FFFF
Subtype=2				ROLIS image test frame (histogram)
2:0	6 words	PARAMS		Image test telecommand parameters

ROSETTA LANDER ÇIVA & ROLIS IME		Acceptance Data Package	
RO-LRS-ADP-3304		Issue 2.1	Model: FM

Offset words:bits	Size	Field	Value	Description
8:0	17 long words	HISTOGRAM	=0..104576	Image histogram, pixel counters: 0: pixel=0 (0 bits) 1: pixel=1 (1 bit) 2: pixel=2..3 (2 bits) 3: pixel=4..7 (3 bits) ... 14: pixel=8192..16382 (14 bits) 15: pixel=16383 (saturated) 16: pixel>16383 (no value)
42:0	86 words	FILL	=FFFFh	Frame is filled with FFFF
Subtype=3				ROLIS IFL position frame
2:0	1 word	IFL-POS	=1..3	Infinity lens position switch
3:0	125 words	FILL	=FFFFh	Frame is filled with FFFF

5.5.6 ROLIS image compression

After wavelet decomposition (5,3) the image is partitioned into 16x16 tiles of 64x64 pixels. Tiles are enumerated 0..255 in the following order:

0	1	...	15
16	17	...	31
...
240	241	...	255

To support the transmission of a Region Of Interest (ROI) different parts of the image can be transmitted with different compression rates.

M tiles are grouped together to fill N telemetry frames. Within a group each tile will be compressed at the same bit rate.

There are 16 predefined data/compression rates (RATE=0..15), each of them defining a (M,N) pair and therefore defining a bit rate / compression rate.

Each tile starts at a full byte position. Thus the byte rate per tile can be calculated as SIZE=252*N/M.

Tiles can spread over several frames and one frame can contain several tiles.

An additional frame counter (FCOUNT=0..N-1) is needed to identify the tile positions within a frame. This is especially important in case of some telemetry data lost.

The following data rates are defined. The calculation of the compression rate assumes 14 bits per pixel.

ROSETTA LANDER ÇIVA & ROLIS IME	Acceptance Data Package	
RO-LRS-ADP-3304	Issue 2.1	Model: FM

Table 5.5.6-1 : Compression rates

RATE	M tiles	N frames	Bytes per tile	Bits per pixel	Compression rate
0	1	16	4032	7.88	1.8
1	1	12	3024	5.91	2.7
2	1	8	2016	3.94	3.6
3	1	6	1512	2.95	4.7
4	1	4	1008	1.97	7,1
5	1	3	756	1.48	9.5
6	2	5	630	1.23	11.4
7	1	2	504	0.98	14.2
8	3	5	420	0.82	17.1
9	2	3	378	0.74	19.0
10	3	4	336	0.66	21.3
11	1	1	252	0.49	28.4
12	5	4	201	0.39	35.6
13	3	2	168	0.33	42.7
14	2	1	126	0.25	56.9
15	3	1	84	0.16	85.3

Each tile has a header, defining the image, the tile number (location) and the most significant bit of the whole tile (MSB):

Table 5.5.6-2 : TILE-DATA details

	Offset words:bits	Size	Field	Value	Description
TILE-DATA					Tiles may spread over several frames, one frame may contain more than one tile
	0:0	8 Bits	TILE-NUM	0..255	Tile number
	0:8	3 Bits	TILE-IMG	=0..7	Image number
	0:11	5 Bits	TILE-MSB	=1..22	Most significant bit of the whole tile
	1:0	SIZE-2	TILE-CODE		Coded tile data, M tiles in N frames = 252*N/M-2 Bytes

ROSETTA LANDER ÇIVA & ROLIS IME	Acceptance Data Package	
RO-LRS-ADP-3304	Issue 2.1	Model: FM

5.5.7 ÇIVA telemetry

5.5.7.1 Çiva Units and subunits

The telemetry stream from ÇIVA is structured consistently with the structure of the experiment. There are 9 subsystems, which can be activated independently after each switch-on of ÇIVA, depending on a control parameter. Each subsystem is considered as an independent unit in terms of control and telemetry, which can be activated in the following order:

Units 6,7: Stereoscopic cameras

Units 1 to 5: Panoramic cameras

Unit 9: Visible microscope

Unit 8: Infrared microscope

Each unit can be activated by setting 3 dedicated bits (majority rule) in the first 32-bit parameter.

Each unit from 1 to 7 (ÇIVA-P) provides an image 1024 x 1024 formatted as 64 sub-images of 128 x 128 pixels.

Units 8 and 9 (the infrared and visible microscope) are further structured into sub-units for operations and telemetry

➔ For the Visible microscope: always 3 sub-units

Sub-unit 9.0: 1024 x 1024 image with the “IR” LED on

Sub-unit 9.1: 1024 x 1024 image with the “Green” LED on

Sub-unit 9.2: 1024 x 1024 image with the “Red” LED on

Each of these sub-units is formatted similarly to the camera images as 64 sub-images of 128 x 128 pixels.

➔ For the Infrared microscope: 13 sub-units (nominal) with the following structure:

Sub-unit 8.0 : initial dark reference sequence (4 images with the 4 possible integration times, then lamp on, then reference search, then 4 images with the 4 possible integration times, then filter on: nominal position for short wavelengths) constituted of eight bit-packed 128 x 96 images.

Sub-units 8.1 to 8.11 : a data cube of K images of 96 x 128 pixels formatted as 96 “sub-slices” of K spectels by 128 pixels, corresponding to successive sets of K positions of the grating. K is set as 80 spectels until a programmable subcycle, change_IR is reached. It is then set as 64 spectels until the end of the scan (default: 704 steps with change_IR=0)

Sub-unit 8.12 : final dark reference sequence (search reference, then 4 images with the 4 possible integration times, then lamp off, then four images with the 4 possible acquisition times) constituted of eight bit-packed 128 x 96 images. At this stage, the filter is already off (nominal position for long wavelengths)

The nominal operating sequence for the IR microscope runs through the 13 sub-units. It is however possible to stop the operating sequence after any sub-unit through a specific TC parameter, end_IR, which indicates after how many subcycles the program should skip the remainder of the scan and go to the final dark reference acquisition sequence (still labelled as subunit 8.12).

ROSETTA LANDER ÇIVA & ROLIS IME	Acceptance Data Package	
RO-LRS-ADP-3304	Issue 2.1	Model: FM

5.5.7.2 Çiva Data Format

5.5.7.2.1 ÇIVA Science Data

The data from the ÇIVA experiment are sent as messages of at most 127 words through ROLIS, then the CDMS of the lander to the ROSETTA orbiter and to the ground. The first word of each message must have “1100” (C hexadecimal) as its 4 MS bits, as “C” (hex) is the code for ÇIVA TC and TM data. The number of words in each message (< 128) is indicated in the LsByte of the first word of the message. Each sub-image or sub-slice from a sub-unit is compressed and formatted independently as a self-consistent chain of messages.

There are 4 types of ÇIVA messages, with a type indicated by the bits 12 to 15 of the first word of the message:

- C1NN: first message of a chain of messages corresponding to a sub-image (units 1 to 7 and 9, sub-unit 8.0 and 8.12) or a sub-slice (unit 8, sub-units 1 to 11), with NN words in the message. header. NN is 127 (7F hex) unless a sub-image requires only one message
- C27F: next messages of a chain of messages, always with 127 words in the message
- C3NN: last message of a chain of messages, with $3 < NN < 128$
- CFNN: “HK” message, next to last sent in a ÇIVA session, reporting the active set of control parameters and the main events during the session, in particular the activated units and sub-units
- CENN: “error status” message, last sent in a ÇIVA session, reporting the number of errors and request messages (HK and LOBT).

All “data” messages (types C1, C2, C3) start with a header with 3 words, apart from the first data message for the first sub-image or sub-slice of a sub-unit (hence always of type C1) for which the header consists of 5 words. At most 124 data words can be sent per message.

The second word of the header is constituted of two fields of 8 bits each:

Bits 15-8 : compression parameter MM

bit 15: simulated data if set;

bit 14: spectral (set) or spatial (reset);

bits 13 to 8: bit rate from 0 to 63 (0: bit-packed; 1: reversible; 2 to 63: bit per data x 16)

Bits 7-0 : total number of messages in the chain for type C1, otherwise rank of the message in the chain.

The third word of the header is constituted of three fields:

Bits 15-12: unit

Bits 11- 8 : sub-unit (always 0 for units 1 to 7, 0 to 12 for unit 8, 0 to 2 for unit 9)

Bits 7- 0 : sub-image or sub-slice (0 or 1 for sub-units 8.0 and 8.12, 0 to 95 for sub-units 8.1 to 8.11, 0 to 63 for all other sub-units)

In the specific case of the very first message for a given sub-unit, two additional 16-bits words are appended to the header. The second word has a specific meaning for ÇIVA MI (unit 8):

- first word: integration time, in msec for cameras, in “MID msec” for the IR imaging ($4096 \cdot 1.2 \mu\text{sec} / 5$, or 0.983 msec). Caution: for sub-cycles 0 and 12 (calibration) this integration time is set as $t_{\text{min}} \cdot 5$, while all four possible integration times $5 \cdot (t_{\text{min}}, t_{\text{min}} \cdot 1.72, t_{\text{min}} \cdot 3, t_{\text{min}} \cdot 5.19)$ are used with and without the lamp
- second word, cameras and visible microscope: bias command (16 bits)
- second word, IR microscope: number of grating positions (MSbyte), Vref parameter (LSbyte). In previous versions, the MSbyte was E4 (full command).

5.5.7.2.2 ÇIVA Handling of the Lander On-board Time (LOBT)

ROSETTA LANDER ÇIVA & ROLIS IME	Acceptance Data Package	
RO-LRS-ADP-3304	Issue 2.1	Model: FM

The Lander Board Time (LOBT) is a 32 bits number which is incremented each 1/32 s. It is initialised at 0, but can be synchronized by a specific command from the orbiter, which selects the relevant sets of bits in the Orbiter On-Board Time (OOT). The LOBT is sent to ROLIS by the CDMS every second (nominal mode). 128 LOBT messages are expected between two HK requests by the CDMS to ROLIS (128 sec intervals). ROLIS relays each LOBT to ÇIVA through a specific LOBT message. On reception of this message, the current value of the ÇIVA Board time is updated by the LOBT. When dating events such as the start of the activity of a unit (or sub-unit), ÇIVA adds $(10 \cdot \text{ticks})/32$ to the ÇIVA Board time, where ticks is the number of 10 msec clock counts since the last LOBT.

5.5.7.2.3 ÇIVA Housekeeping Data

The housekeeping message (CFNN) is sent just before the “end of activity” message to ROLIS which indicates that ÇIVA can be switched off. It consists of the following sequence of 32-bits words:

- version number (00000704 : version 7, level 4)
 - 28 control parameters of ÇIVA (16 bits) which were used during operation (hence after updating by the ÇIVA parameter TC).
 - 1111 (2 bytes) followed by 1 byte for the unit and 1 byte for the sub-unit
 - updated board time in seconds for each activated unit and sub-unit for ÇIVA-MV. Each board-time message (LOBT) from the CDMS redefines the board time (unit: 1/32 s), and a “ticks_ref” variable to the current number of clock ticks (10 msec). The board time, increased by 10/32 for each tick since ticks_ref, is indicated at the beginning of the sub-unit, with the exception of the last sub-unit of ÇIVA MI (sub-unit 12), when it is indicated at the end of all MI operations.
 - AA000000 + nb of camera / MID interrupts at the end of each activated cycle
 - 5555 5555 followed by 3 words sent back by the MID after a parameter request command
- Two such requests are made, during each of the two calibration sub-cycles of ÇIVA MI (sub-cycles 8_0 and 8_C).
- BB000000+number of steps in the reference search (one for each of the two cal sub-cycles)

Example1: Stereo pair acquisition

```

07050000      version number
2000003F      a stereo pair is requested with two cleans
4010CC4A
4010CC4A
4010CC4A
4010CC4A
4010CC4A
4010CC4A
4010CC4A
4010CC4A
4010CC4A
B10CC4A
C10CC4A
D10CC4A
4860661F      nb_step=72, spectral, 2 bits/data, tint1=0, tint2=31 (tmin=160 msec)
C0FE5FC7      deadpot, testb, vref, full scan, lamp level 2, dark subtraction
333A5006      chang_IR=3, CAP (gain)=3, tint: 2,1,0,0,0,0,1,1,2,2,3
11110600      unit 6, sub-unit 0
BOARDT_0 (start of actual acquisition, after the cleans)

```

ROSETTA LANDER ÇIVA & ROLIS IME	Acceptance Data Package	
RO-LRS-ADP-3304	Issue 2.1	Model: FM

AA000006 six interrupts (nominal)
11110700 unit 7, sub-unit 0
BOARDT_1 (start of actual acquisition, after the cleans)
AA000006 six interrupts (nominal)
11110100
11110200
11110300
11110400
11110500
11110900
11110800

Example 2: ÇIVA MI acquisition, 4 sub-cycles requested before the final calibration:

07050000 version number
07000000 ÇIVA MI requested
4010CC4A
4010CC4A
4010CC4A
4010CC4A
4010CC4A
4010CC4A
4010CC4A
4010CC4A
B10CC4A
C10CC4A
D10CC4A
48606627 nb_step=72, spectral, 2 bits/data, tint1=0, tint2=39 (tmin=200 msec)
C0FE5F4B deadpot, testb, vref, full scan, lamp level 2, 4+1 MI sub-cycles, dark subtraction
331B1B1B chang_IR=3, CAP (gain)=3 (max), tint: 3,2,1,0,3,2,1,0,3,2,1
11110600
11110700
11110100
11110200
11110300
11110400
11110500
11110900
11110800
80000001 (no board time received: initialisation at 0x80000000)
55555555
000000AF
00000002
000000D0 (no MID: voltage request command is not overwritten)
BB0004B0 (1200 back steps with no reference found (no MI))
BB00xxxx (number of steps after retry)
11110801
8000004C
11110802

ROSETTA LANDER ÇIVA & ROLIS IME	Acceptance Data Package	
RO-LRS-ADP-3304	Issue 2.1	Model: FM

800000C9
11110803
8000011B
1111080C
BB0004B0 (no reference found)
BB00xxxx (number of steps after retry)
55555555
000000AF
00000002
000000D0
8000018F
AA000115 277 command interruptions (30+81+81+65+20), no return interruptions (no MID).

5.5.7.2.4 Anomaly report message (CENN)

This message used for debugging purposes is sent by ÇIVA just before “end of activity”. It contains the following information, interpreted by “ÇIVA_uncompress”:

- 3 types of errors (only error header is implemented in ÇIVA 7_4)
- number of TC
- number of messages sent
- number of HK requests
- number of LOBT updates

5.5.7.2.5 Format of the HK reports

These packets are emitted by ROLIS upon request from the CDMS, nominally every 128 seconds. A field of 16 words of 16 bits is allocated to ÇIVA. They are updated when ROLIS issues a HK request message to ÇIVA, which answers with the current status of the relevant status and parameters.

These 16 slots contain the following information

1. rank of the HK message
2. last received LOBT (MSW)
3. last received LOBT (LSW)
4. unit of the last complete sub-unit (8 bits) and last complete sub-unit (8 bits)
5. number of camera interrupts from the unit at the end of the last complete sub-unit
6. total number of 32-bits compressed words for the sub-unit (MSW)
7. total number of 32-bits compressed words for the sub-unit (LSW)
8. total number of messages prepared at the end of the last complete sub-unit
9. current number of messages still in the low priority stack (stack full : 2FFF hexadecimal)
10. number of “Message Repeat” messages from ROLIS (anomaly)
11. number of “Message Request” messages from ROLIS (nominal)
12. number of ROLIS messages rejected due to a wrong header
13. set to 0
14. number of TC messages from ROLIS (nominally 1 except during upload)
15. number of LOBT updates
16. set to 0

After the end of processing (once the “end of activity” message is on the stack), words 4,5,6,7 and 8 should stay constant. The rank should increment, the ÇIVA board time should increase, and word 9

ROSETTA LANDER ÇIVA & ROLIS IME	Acceptance Data Package
RO-LRS-ADP-3304	Issue 2.1 Model: FM

should decrease by the same amount as that by which word 11 increases, following the transfer of the stack by message requests from ROLIS.

5.5.7.2.6 ÇIVA Data Format

Table 5.5.7.2.6-1 summarizes the telemetry format for the two first chains of Science Data from Packet #0 to Packet #N-1, Chain one differing from the following ones by the presence inside Packet #0 of Words #3 and #4 which content Parameters data instead of Science data. Each packet has 128*16 bits words but the last one which is limited to one 16 bits header plus NW*16 bits significant words followed by (127-NW)*16 bits non significant words.

Table 5.5.7.2.6-1: ÇIVA telemetry format (two first chains)

Chain #1	b15	b14	b13	b12	b11	b10	b9	b8	b7	b6	b5	b4	b3	b2	b1	b0	
P0	W0	Çiva Code = C hex				Packet type (first packet of a chain) = 1 hex				Number of following significant words in the present packet = 7F hex							
	W1	Compression parameter = MM hex								Total number N of packets in the chain							
	W2	Unit number				Sub-unit number				Sub-image or Sub-slice number							
	W3 (1)	Integration time in ms (or "MID ms" for Çiva-M/I)															
	W4 (1)	Bias (Çiva-P cameras and Çiva-M/V camera) or E4 vref (Çiva-M/I camera) voltages															
	W5	Çiva Science Data															
	:	:															
W126	Çiva Science Data																
W127	Çiva Check-Sum																
P1	W0	Çiva Code = C hex				Packet type (first packet of a chain) = 2 hex				Number of following significant words in the present packet = 7F hex							
	W1	Compression parameter								Rank (1) of the packet in the chain							
	W2	Unit number				Sub-unit number				Sub-image or Sub-slice number							
	W3	Çiva Science Data															
	:	:															
	W126	Çiva Science Data															
	W127	Çiva Check-Sum															
P2	W0	Çiva Code = C hex				Packet type (third packet of a chain) = 2 hex				Number of following significant words in the present packet = 7F hex							
	W1	Compression parameter								Rank (2) of the packet in the chain							
	W2	Unit number				Sub-image or Sub-slice number				Sub-image or Sub-slice number							
	W3	Çiva Science Data															
	:	:															
	W126	Çiva Science Data															
	W127	Çiva Check-Sum															
P3	W0	Çiva Code = C hex				Packet type (fourth packet of a chain) = 2 hex				Number of following significant words in the present packet = 7F hex							
	W1	Compression parameter								Rank (3) of the packet in the chain							
	W2	Unit number				Sub-image or Sub-slice number				Sub-image or Sub-slice number							
	W3	Çiva Science Data															
	:	:															
	W126	Çiva Science Data															
	W127	Çiva Check-Sum															
:	:																
P(N-1)	W0	Çiva Code = C hex				Packet type (last packet of a chain) = 3 hex				Number of following significant words in the present packet = NW hex							
	W1	Compression parameter								Rank (N-1) of the packet in the chain							
	W2	Unit number				Sub-image or Sub-slice number				Sub-image or Sub-slice number							
	W3	Çiva Science Data															
	:	:															
	W(NW-1)	Çiva Science Data															
	W(NW)	Çiva Check-Sum															
W(NW+1)	Not significant																
:	:																
W127	Not significant																

- Notes:** 1- W3 and W4 are present if sub-image or sub-slice number = 0 only
2- Italic characters mean optional words which are present if the unit, sub-unit or sub-cycle are activated only

ROSETTA LANDER ÇIVA & ROLIS IME	Acceptance Data Package
RO-LRS-ADP-3304	Issue 2.1
Model: FM	

Chain #2		b15	b14	b13	b12	b11	b10	b9	b8	b7	b6	b5	b4	b3	b2	b1	b0
P0	W0	Çiva Code = C hex				Packet type (first packet of a chain) = 1 hex				Number of following significant words in the present packet = 7F hex							
	W1	Compression parameter = MM hex								Total number N of packets in the chain							
	W2	Unit number				Sub-unit number				Sub-image or Sub-slice number							
	W3	Çiva Science Data															
	W4	Çiva Science Data															
	W5	Çiva Science Data															
	:	:															
	W126	Çiva Science Data															
	W127	Çiva Check-Sum															
P1	W0	Çiva Code = C hex				Packet type (first packet of a chain) = 2 hex				Number of following significant words in the present packet = 7F hex							
	W1	Compression parameter								Rank of the packet in the chain (1)							
	W2	Unit number				Sub-unit number				Sub-image or Sub-slice number							
	W3	Çiva Science Data															
	:	:															
	W126	Çiva Science Data															
	W127	Çiva Check-Sum															
P2	W0	Çiva Code = C hex				Packet type (third packet of a chain) = 2 hex				Number of following significant words in the present packet = 7F hex							
	W1	Compression parameter								Rank of the packet in the chain (2)							
	W2	Unit number				Sub-image or Sub-slice number				Sub-image or Sub-slice number							
	W3	Çiva Science Data															
	:	:															
	W126	Çiva Science Data															
	W127	Çiva Check-Sum															
P3	W0	Çiva Code = C hex				Packet type (fourth packet of a chain) = 2 hex				Number of following significant words in the present packet = 7F hex							
	W1	Compression parameter								Rank of the packet in the chain (3)							
	W2	Unit number				Sub-image or Sub-slice number				Sub-image or Sub-slice number							
	W3	Çiva Science Data															
	:	:															
	W126	Çiva Science Data															
	W127	Çiva Check-Sum															
:	:	:															
P(N-1)	W0	Çiva Code = C hex				Packet type (last packet of a chain) = 3 hex				Number of following significant words in the present packet = NW hex							
	W1	Compression parameter								Rank of the packet in the chain (N-1)							
	W2	Unit number				Sub-image or Sub-slice number				Sub-image or Sub-slice number							
	W3	Çiva Science Data															
	:	:															
	W(NW-1)	Çiva Science Data															
	W(NW)	Çiva Check-Sum															
	W(NW+1)	Not significant															
	:	:															
	W127	Not significant															

Examples:

Headers of a chain of messages corresponding to sub-image 31 of sub-unit 9.1 (image from the visible microscope with the green LED on), real data, spatial wavelet compression with 0.5 bit per data. This requires $(128 * 128 * 0.5 / 16) = 512$ compressed 16-bits words, hence 5 full messages and $512 - 4 * 124 + 3 = 19$ words for the last message:

C17F 0805 911F
C27F 0801 911F
C27F 0802 911F
C27F 0803 911F
C313 0804 911F

Headers of a chain of messages corresponding to the 1st sub-slice (sub-slice 0) of sub-unit 8.3 (spectels 160 to 224 from the IR microscope), 320 msec integration time, vref= 5F (hex), real data, spectral wavelet compression with 1 bits per data. This also requires 512 compressed 16-bits words ($64 * 128 / 16$), hence 5 full messages but now 21 words are needed for the last message as the first header is 2 words longer for the first sub-slice:

C17F 5005 8300 0140 E45F
 C27F 5001 8300
 C27F 5002 8300
 C27F 5003 8300
 C315 5004 8300

The previous science packets are followed by the next two HK packets which end one complete data stream.

Table 5.5.7.2.6-2: ÇIVA telemetry format (HK packets)

P(N)	W0	b15	b14	b13	b12	b11	b10	b9	b8	b7	b6	b5	b4	b3	b2	b1	b0
	W1	Çiva Code = C hex				Packet type (housekeeping data) = F				Number of following significant words in the present packet = NW hex							
	W2	Çiva software version number (ex: 0705 hex)															
	W3	Çiva software version number (ex: 000x hex)															
	W4	Çiva control parameter 1 (see Çiva Telecommands, § 5.4.5)															
	W5	Çiva control parameter 2 (see Çiva Telecommands, § 5.4.5)															
	W6	Çiva control parameter 3 (see Çiva Telecommands, § 5.4.5)															
	:	:															
	W29	Çiva control parameter 27 (see Çiva Telecommands, § 5.4.5)															
	W30	Çiva control parameter 28 (see Çiva Telecommands, § 5.4.5)															
	W31	1111															
	W32	Number of the first tested unit (Çiva-P #6 camera): 06								00							
	W33	Start time of the Çiva-P #6 (MSB)															
	W34	Start time of the Çiva-P #6 (LSB)															
	W35	AA00															
	W36	Number of interrupts for the Çiva-P #6															
	Wu=	1111															
	W33 or W37	Number of the second tested unit (Çiva-P #7 camera): 07								00							
	Wu+1	Start time of the Çiva-P #7 (MSB)															
	Wu+2	Start time of the Çiva-P #7 (LSB)															
	Wu+3	AA00															
	Wu+4	Start time of the Çiva-P #7 (LSB)															
	Wu+5	:															
	:	:															
	Wz	1111															
	Wz+1	0500															
	Wz+2	Start time of the Çiva-P #5 (MSB)															
	Wz+3	Start time of the Çiva-P #5 (LSB)															
	Wz+4	AA00															
	Wz+5	Number of interrupts for the Çiva-P #5															
	Wvv	1111															
	Wvv+1	0900															
	Wvv+2	Start time of the first Çiva-M/V sub-cycle (MSB)															
	Wvv+3	Start time of the first Çiva-M/V sub-cycle (LSB)															
	Wvv+4	1111															
	Wvv+5	0901															
	Wvv+6	Start time of the second Çiva-M/V sub-cycle (MSB)															
	Wvv+7	Start time of the second Çiva-M/V sub-cycle (LSB)															
	Wvv+8	1111															
	Wvv+9	0902															
	Wvv+10	Start time of the third Çiva-M/V sub-cycle (MSB)															
	Wvv+11	Start time of the third Çiva-M/V sub-cycle (LSB)															
	Wvv+12	AA00															
	Wvv+13	Total number of interrupts for the Çiva-M/V activated cycle															
	Www	1111															
	Www+1	Number of the first Çiva-M/I tested cycle: 08								Number of the first Çiva-M/I tested sub-cycle: 00							
	Www+2	Start time of the first Çiva-M/I sub-cycle (Calibration, MSB)															
	Www+3	Start time of the first Çiva-M/I sub-cycle (Calibration, LSB)															
	Www+4	5555 (first Çiva-M/I calibration sub-cycle)															
	Www+5	5555 (first Çiva-M/I calibration sub-cycle)															
	Www+6	Çiva-MID parameter 1 (first Çiva-M/I calibration sub-cycle): 00								Çiva-MID parameter 1 (first Çiva-M/I calibration sub-cycle): TestB							
	Www+7	Çiva-MID parameter 2 (first Çiva-M/I calibration sub-cycle): 00								Çiva-MID parameter 2 (first Çiva-M/I calibration sub-cycle): DeadPot							
	Www+8	Çiva-MID parameter 3 (first Çiva-M/I calibration sub-cycle): 00								Çiva-MID parameter 3 (first Çiva-M/I calibration sub-cycle): ABAMPHI							
	Www+9	Çiva-MID parameter 4 (first Çiva-M/I calibration sub-cycle): 00								Çiva-MID parameter 4 (first Çiva-M/I calibration sub-cycle): Vref							
	Www+10	Çiva-MID parameter 5 (first Çiva-M/I calibration sub-cycle): 00								Çiva-MID parameter 5 (first Çiva-M/I calibration sub-cycle): Temp							
	Www+11	Çiva-MID parameter 6 (first Çiva-M/I calibration sub-cycle): 00								Çiva-MID parameter 6 (first Çiva-M/I calibration sub-cycle): DIGATE							
	Www+12	BB00															
	Www+13	Number of steps in the reference search (during the first Çiva-M/I calibration sub-cycle)															
	Www+14	BB00															
	Www+15	Number of step in the reference search after retry (during the first Çiva-M/I calibration sub-cycle)															

		b15	b14	b13	b12	b11	b10	b9	b8	b7	b6	b5	b4	b3	b2	b1	b0
	Wxx	1111															
	Wxx+1	Number of the second Çiva-M/I tested cycle: 08								Number of the second Çiva-M/I tested sub-cycle: 01							
	Wxx+2	Start time of the second Çiva-M/I activated sub-cycle (MSB)															
	Wxx+3	Start time of the second Çiva-M/I activated sub-cycle (LSB)															
	:	:															
	Wyy	1111															
	Wyy+1	Number of the eleventh Çiva-M/I tested cycle: 08								Number of the eleventh Çiva-M/I tested sub-cycle: 0B							
	Wyy+2	Start time of the eleventh Çiva-M/I activated sub-cycle (MSB)															
	Wyy+3	Start time of the eleventh Çiva-M/I activated sub-cycle (LSB)															
	Wzz	1111															
	Wzz+1	Number of the last Çiva-M/I tested cycle: 08								Number of the last Çiva-M/I tested sub-cycle: 0C							
	Wzz+2	BB00															
	Wzz+3	Number of steps in the reference search (after the last Çiva-M/I calibration sub-cycle)															
	Wzz+4	BB00															
	Wzz+5	Number of step in the reference search after retry (after the last Çiva-M/I calibration sub-cycle)															
	Wzz+6	5555 (last Çiva-M/I sub-cycle: calibration)															
	Wzz+7	5555 (last Çiva-M/I sub-cycle: calibration)															
	Wzz+8	Çiva-MID parameter 1 (last Çiva-M/I calibration sub-cycle): 00								Çiva-MID parameter 1 (last Çiva-M/I calibration sub-cycle): TestB							
	Wzz+9	Çiva-MID parameter 2 (last Çiva-M/I calibration sub-cycle): 00								Çiva-MID parameter 2 (last Çiva-M/I calibration sub-cycle): DeadPot							
	Wzz+10	Çiva-MID parameter 3 (last Çiva-M/I calibration sub-cycle): 00								Çiva-MID parameter 3 (last Çiva-M/I calibration sub-cycle): ABAMPHI							
	Wzz+11	Çiva-MID parameter 4 (last Çiva-M/I calibration sub-cycle): 00								Çiva-MID parameter 4 (last Çiva-M/I calibration sub-cycle): Vref							
	Wzz+12	Çiva-MID parameter 5 (last Çiva-M/I calibration sub-cycle): 00								Çiva-MID parameter 5 (last Çiva-M/I calibration sub-cycle): Temp							
	Wzz+13	Çiva-MID parameter 6 (last Çiva-M/I calibration sub-cycle): 00								Çiva-MID parameter 6 (last Çiva-M/I calibration sub-cycle): DIGATE							
	Wzz+14	Start time of the last Çiva-M/I activated sub-cycle (Calibration, MSB)															
	Wzz+15	Start time of the last Çiva-M/I activated sub-cycle (Calibration, LSB)															
	Wzz+16	AA00															
	Wzz+17	Total number of interrupts for the Çiva-M/I activated cycle															
	W(NW)	Çiva Check-Sum															
	W(NW+1)	Not significant															
	:	:															
	W127	Not significant															
P(N+1)	W0	Çiva Code = C hex				Packet type (housekeeping data) = E				Number of following significant words in the present packet = 0C hex							
	W1	0000															
	W2	EEEE															
	W3	Error type 1															
	W4	Error type 2															
	W5	Error type 3															
	W6	AAAA															
	W7	Number of TC															
	W8	Number of messages sent															
	W9	Number of messages requests with the repeat flag set															
	W10	Number of HK requests															
	W11	Number of LOBT updates															
	W12	Çiva Check-Sum															
	W13	Not Significant															
	:	:															
	W127	Not Significant															

Note: the Çiva-MID parameters can also begin with parameter #2 (DeadPot) followed by #3, #4, #5 and #6. Then, parameter #1 is absent and the sixth word having no meaning has to be disregarded.

The content of the first HK packet depends on the activated unit as shown in the following tables.

Table 5.5.7.2.6-3: ÇIVA telemetry format (First HK packet when Çiva-P activated)

P(N)	W0	b15	b14	b13	b12	b11	b10	b9	b8	b7	b6	b5	b4	b3	b2	b1	b0
		Çiva Code = C hex				Packet type (housekeeping data) = F hex				Number of following significant words in the present packet = NW hex							
	W1	Çiva software version number (ex: 0705 hex)															
	W2	Çiva software version number (ex: 000x hex)															
	W3	Çiva control parameter 1 (see Çiva Telecommands, § 5.4.5)															
	W4	Çiva control parameter 2 (see Çiva Telecommands, § 5.4.5)															
	W5	Çiva control parameter 3 (see Çiva Telecommands, § 5.4.5)															
	W6	Çiva control parameter 4 (see Çiva Telecommands, § 5.4.5)															
	:	:															
	W29	Çiva control parameter 27 (see Çiva Telecommands, § 5.4.5)															
	W30	Çiva control parameter 28 (see Çiva Telecommands, § 5.4.5)															
	W31	1111															
	W32	0600															
	W33	<i>Start time of the Çiva-P #6 if activated (MSB)</i>															
	W34	<i>Start time of the Çiva-P #6 if activated (LSB)</i>															
	W35	AA00															
	W36	<i>Number of interrupts for the Çiva-P #6 if activated</i>															
	Wu=	1111															
	W33 or W37																
	Wu+1	0700															
	Wu+2	<i>Start time of the Çiva-P #7 if activated (MSB)</i>															
	Wu+3	<i>Start time of the Çiva-P #7 if activated (LSB)</i>															
	Wu+4	AA00															
	Wu+5	<i>Number of interrupts for the Çiva-P #7 if activated</i>															
	Wv	1111															
	Wv+1	0100															
	Wv+2	<i>Start time of the Çiva-P #1 if activated (MSB)</i>															
	Wv+3	<i>Start time of the Çiva-P #1 if activated (LSB)</i>															
	Wv+4	AA00															
	Wv+5	<i>Number of interrupts for the Çiva-P #1 if activated</i>															
	Ww	1111															
	Ww+1	0200															
	Ww+2	<i>Start time of the Çiva-P #2 if activated (MSB)</i>															
	Ww+3	<i>Start time of the Çiva-P #2 if activated (LSB)</i>															
	Ww+4	AA00															
	Ww+5	<i>Number of interrupts for the Çiva-P #2 if activated</i>															
	Wx	1111															
	Wx+1	0300															
	Wx+2	<i>Start time of the Çiva-P #3 if activated (MSB)</i>															
	Wx+3	<i>Start time of the Çiva-P #3 if activated (LSB)</i>															
	Wx+4	AA00															
	Wx+5	<i>Number of interrupts for the Çiva-P #3 if activated</i>															
	Wy	1111															
	Wy+1	0400															
	Wy+2	<i>Start time of the Çiva-P #4 if activated (MSB)</i>															
	Wy+3	<i>Start time of the Çiva-P #4 if activated (LSB)</i>															
	Wy+4	AA00															
	Wy+5	<i>Number of interrupts for the Çiva-P #4 if activated</i>															
	Wz	1111															
	Wz+1	0500															
	Wz+2	<i>Start time of the Çiva-P #5 if activated (MSB)</i>															
	Wz+3	<i>Start time of the Çiva-P #5 if activated (LSB)</i>															
	Wz+4	AA00															
	Wz+5	<i>Number of interrupts for the Çiva-P #5 if activated</i>															
	W(WN-4)	1111															
	W(WN-3)	0900															
	W(WN-2)	1111															
	W(WN-1)	0800															
	W(WN)	Çiva Check-Sum															
	W(WN+1)	Not significant															
	:	:															
	W127	Not significant															

Table 5.5.7.2.6-4: ÇIVA telemetry format (First HK packet when Çiva-M/V activated)

P(N)	W0	b15	b14	b13	b12	b11	b10	b9	b8	b7	b6	b5	b4	b3	b2	b1	b0
		Çiva Code = C hex				Packet type (housekeeping data) = F hex				Number of following significant words in the present packet = 3D hex							
	W1	Çiva software version number (ex: 0705 hex)															
	W2	Çiva software version number (ex: 000x hex)															
	W3	Çiva control parameter 1 (see Çiva Telecommands, § 5.4.5)															
	W4	Çiva control parameter 2 (see Çiva Telecommands, § 5.4.5)															
	W5	Çiva control parameter 3 (see Çiva Telecommands, § 5.4.5)															
	W6	Çiva control parameter 4 (see Çiva Telecommands, § 5.4.5)															
	:	:															
	W29	Çiva control parameter 27 (see Çiva Telecommands, § 5.4.5)															
	W30	Çiva control parameter 28 (see Çiva Telecommands, § 5.4.5)															
	W31	1111															
	W32	0600															
	W33	1111															
	W34	0700															
	W35	1111															
	W36	0100															
	W37	1111															
	W38	0200															
	W39	1111															
	W40	0300															
	W41	1111															
	W42	0400															
	W43	1111															
	W44	0500															
	W45	1111															
	W46	0900															
	W47	Start time of the first Çiva-M/V sub-cycle if Çiva-M/V activated (MSB)															
	W48	Start time of the first Çiva-M/V sub-cycle if Çiva-M/V activated (LSB)															
	W49	1111															
	W50	0901															
	W51	Start time of the second Çiva-M/V sub-cycle if Çiva-M/V activated (MSB)															
	W52	Start time of the second Çiva-M/V sub-cycle if Çiva-M/V activated (LSB)															
	W53	1111															
	W54	0902															
	W55	Start time of the third Çiva-M/V sub-cycle if Çiva-M/V activated (MSB)															
	W56	Start time of the third Çiva-M/V sub-cycle if Çiva-M/V activated (LSB)															
	W57	AA00															
	W58	Total number of interrupts for the Çiva-M/V activated cycle															
	W59	1111															
	W60	0800															
	W61	Çiva Check-Sum															
	W62	Not significant															
	:	:															
	W127	Not significant															

Table 5.5.7.2.6-5: ÇIVA telemetry format (First HK packet when Çiva-M/I activated)

P(N)	W0	b15	b14	b13	b12	b11	b10	b9	b8	b7	b6	b5	b4	b3	b2	b1	b0
		Çiva Code = C hex				Packet type (housekeeping data) = F hex				Number of following significant words in the present packet = NW hex							
	W1	Çiva software version number (ex: 0705 hex)															
	W2	Çiva software version number (ex: 000x hex)															
	W3	Çiva control parameter 1 (see Çiva Telecommands, § 5.4.5)															
	W4	Çiva control parameter 2 (see Çiva Telecommands, § 5.4.5)															
	W5	Çiva control parameter 3 (see Çiva Telecommands, § 5.4.5)															
	W6	Çiva control parameter 4 (see Çiva Telecommands, § 5.4.5)															
	:	:															
	W29	Çiva control parameter 27 (see Çiva Telecommands, § 5.4.5)															
	W30	Çiva control parameter 28 (see Çiva Telecommands, § 5.4.5)															
	W31	1111															
	W32	0600															
	W33	1111															
	W34	0700															
	W35	1111															
	W36	0100															
	W37	1111															
	W38	0200															
	W39	1111															
	W40	0300															
	W41	1111															
	W42	0400															
	W43	1111															
	W44	0500															
	W45	1111															
	W46	0900															
	W47	1111															
	W48	0800															
	W49	Start time of the first Çiva-M/I sub-cycle (Calibration, MSB)															
	W49	Start time of the first Çiva-M/I sub-cycle (Calibration, LSB)															
	W50	5555 (first Çiva-M/I calibration sub-cycle)															
	W51	5555 (first Çiva-M/I calibration sub-cycle)															
	W52	Çiva-MID parameter 1 (first Çiva-M/I calibration sub-cycle): 00								Çiva-MID parameter 1 (first Çiva-M/I calibration sub-cycle): TestB							
	W53	Çiva-MID parameter 2 (first Çiva-M/I calibration sub-cycle): 00								Çiva-MID parameter 2 (first Çiva-M/I calibration sub-cycle): DeadPot							
	W54	Çiva-MID parameter 3 (first Çiva-M/I calibration sub-cycle): 00								Çiva-MID parameter 3 (first Çiva-M/I calibration sub-cycle): ABAMPHI							
	W55	Çiva-MID parameter 4 (first Çiva-M/I calibration sub-cycle): 00								Çiva-MID parameter 4 (first Çiva-M/I calibration sub-cycle): Vref							
	W56	Çiva-MID parameter 5 (first Çiva-M/I calibration sub-cycle): 00								Çiva-MID parameter 5 (first Çiva-M/I calibration sub-cycle): Temp							
	W57	Çiva-MID parameter 6 (first Çiva-M/I calibration sub-cycle): 00								Çiva-MID parameter 6 (first Çiva-M/I calibration sub-cycle): DIGATE							
	W58	BB00 (first Çiva-M/I calibration sub-cycle)															
	W59	Number of steps in the reference search (first Çiva-M/I calibration sub-cycle)															
	W60	BB00 (first Çiva-M/I calibration sub-cycle)															
	W61	Number of steps in the reference search (first Çiva-M/I calibration sub-cycle)															
	W62	1111															
	W63	0801															
	W62	Start time of the second Çiva-M/I activated sub-cycle (MSB)															
	W63	Start time of the second Çiva-M/I activated sub-cycle (LSB)															
	:	:															
	Wyy	1111															
	Wyy+1	080B															
	Wyy+2	Start time of the eleventh Çiva-M/I activated sub-cycle (MSB)															
	Wyy+3	Start time of the eleventh Çiva-M/I activated sub-cycle (LSB)															
	W(NW-18)	1111															
	W(NW-17)	080C															
	W(NW-16)	BB00 (last Çiva-M/I calibration sub-cycle)															
	W(NW-15)	Number of steps in the reference search (last Çiva-M/I calibration sub-cycle)															
	W(NW-14)	BB00 (last Çiva-M/I calibration sub-cycle)															
	W(NW-13)	Number of steps in the reference search (last Çiva-M/I calibration sub-cycle)															
	W(NW-12)	5555 (last Çiva-M/I sub-cycle: calibration)															
	W(NW-11)	5555 (last Çiva-M/I sub-cycle: calibration)															
	W(NW-10)	Çiva-MID parameter 1 (last Çiva-M/I calibration sub-cycle): 00								Çiva-MID parameter 1 (last Çiva-M/I calibration sub-cycle): TestB							
	W(NW-9)	Çiva-MID parameter 2 (last Çiva-M/I calibration sub-cycle): 00								Çiva-MID parameter 2 (last Çiva-M/I calibration sub-cycle): DeadPot							
	W(NW-8)	Çiva-MID parameter 3 (last Çiva-M/I calibration sub-cycle): 00								Çiva-MID parameter 3 (last Çiva-M/I calibration sub-cycle): ABAMPHI							
	W(NW-7)	Çiva-MID parameter 4 (last Çiva-M/I calibration sub-cycle): 00								Çiva-MID parameter 4 (last Çiva-M/I calibration sub-cycle): Vref							
	W(NW-6)	Çiva-MID parameter 5 (last Çiva-M/I calibration sub-cycle): 00								Çiva-MID parameter 5 (last Çiva-M/I calibration sub-cycle): Temp							
	W(NW-5)	Çiva-MID parameter 6 (last Çiva-M/I calibration sub-cycle): 00								Çiva-MID parameter 6 (last Çiva-M/I calibration sub-cycle): DIGATE							
	W(NW-4)	Start time of the last Çiva-M/I activated sub-cycle (Calibration, MSB)															
	W(NW-3)	Start time of the last Çiva-M/I activated sub-cycle (Calibration, LSB)															
	W(NW-2)	AA00															
	W(NW-1)	Total number of interrupts for the Çiva-M/I activated cycle															
	W(NW)	Çiva Check-Sum															
	W(NW+1)	Not significant															
	:	:															
	W127	Not significant															

Note: the Çiva-MID parameters can also begin with parameter #2 (DeadPot) followed by #3, #4, #5 and #6. Then, parameter #1 is absent and the sixth word having no meaning has to be disregarded.

5.5.8 ÇIVA image compression

ÇIVA-P (7 cameras) and ÇIVA MV (3 exposures with different LED's) generate 1024 x 1024 pixel images. These images are partitioned into 8 x 8 sub-images of 128 x 128 pixels. Sub-images are labelled 0 to 63 in the following order (as transferred by the camera head):

56		...	63
		...	
8
0	1	...	7

ÇIVA MI generates 4 calibration images (128 x 128) and 736 images for each position of the grating, from which a central window of 96 x 128 pixels is selected. These 736 images are aggregated as 11 cubes of either 96 x 128 x 80 data (cubes 1 and 2) or 96 x 128 x 64 data (cubes 3 to 11). After acquiring the required number of images (either 80 or 64), each cube is partitioned into 96 sub-slices of either 128 x 80 data (cubes 1 and 2) or 128 x 64 data (cubes 3 to 11). Each sub-slice has therefore a spatial dimension (X) and a spectral dimension (Y).

There are 64 possible levels of image compression for ÇIVA, corresponding to three compression methods:

- level 0: bit packing, each pixel is transmitted as 10 contiguous bits (P, MV) or 12 contiguous bits (MI)
- level 1: reversible compression (typically 6 to 7 bits per data for sub-images, 4 to 5 bits per data for sub-slices)
- level 2 to 63: wavelet compression, with a bit budget of level/16 bits per data (for example, level 16 means 1 bit per data)

The four calibration images from MI are always bit-packed (12 bits per data). The compression level can be selected independently by TC for each of the cameras, each of the 3 exposures of MV, and MI.

Reversible compression of sub-images (P, MV) uses a X-Y DPCA approach, then a coding of the residuals with the Rice algorithm. For reversible compression of sub-slices (MI), one first applies a predictor algorithm based on the largest spectrum in the sub-slice, then a coding of the residuals with the Rice algorithm is performed.

For wavelet compression of sub-images, one first performs a straightforward (dyadic) wavelet transformation using a (8,10) bi-orthogonal filter bank. For wavelet compression of sub-slices, one first applies the same predictor algorithm as for reversible compression, then a specific ("pyramidal") wavelet transformation using the (8,10) filter bank is performed on the residuals, so as to minimize the cross-talk between the spatial and spectral dimensions in the sub-slice. In both cases, a version of the Said-Pearlman algorithm optimised for speed is then applied on the coefficients resulting from the transformation.

When wavelet compression is used on images (ÇIVA-P, ÇIVA-MV), the bit allocation is redistributed along the 8 sub-images constituting a line (e.g. sub-images 0 to 7) depending on the entropy of each sub-image.

ROSETTA LANDER ÇIVA & ROLIS IME	Acceptance Data Package	
RO-LRS-ADP-3304	Issue 2.1	Model: FM

Whatever the compression mode, each sub-image or sub-slice is transmitted as a self-consistent series of frames, as indicated in section 5.5.7 (ÇIVA telemetry).

ROSETTA LANDER ÇIVA & ROLIS IME	Acceptance Data Package	
RO-LRS-ADP-3304	Issue 2.1	Model: FM

5.6 LIST OF IMPLEMENTED CDMS ACTION CODES AND REQUEST CODES

The following table 5.6.1 gives an overview of the usage of different CDMS message types and service requests.

5.6.1 CDMS action codes (Table 5.6.1)

Action Code	T/R	Mnemo	Action code	Broadcast	WRDC	Used ?
0	1	TRSW	Trm status word	not used		yes
1	1	TRQC	Trm request code word	not used	1	yes
2	0	STBY	Standby mode / power Down	yes		not used
3	0	RMOD	Rcv current CDMS mode	yes	1	yes
4	0	RTIM	Rcv onboard time	yes	2	yes
5	0	RSST	Rcv service system status	yes	TBD	yes
6	0	RAXT	Rcv action code extension		1	not used
7	0	RHFM	Rcv HK format count	yes	1	yes
7	1	THKD	Trm HK data word		1	yes
8	0	RCMD	Rcv telecommand sequence		1..32	yes
9	1	TCMO	Trm offset / length of stored telecommand section	not used	2	yes
9	0	RCMS	Rcv stored telecommand buffer section		1..32	yes
10	0	RASV	Rcv allocated science data volume		2	not used
10	1	TSCR	Trm science data burst		4/32	yes
11	0	RBUS	Rcv allocated backup RAM buffer size		1	yes
11	1	TBUP	Trm pointer of backup RAM buffer record		1	yes
12	0	RBUF	Rcv backup RAM buffer record		32	yes
12	1	TBUF	Trm backup RAM buffer record		32	yes
13	0	RERC	Rcv error code word		1	yes
14	0	RTRG	Rcv trigger word	yes	1	
14	1	TTRG	Trm trigger word	not used	1	not used
15	0	RSCS	Rcv science data package check-sum	not used	1	

5.6.2 CDMS Service Request Codes (Table 5.6.2)

SR Code	Mnemo	Service Request Code	Used ?
1	SSST	Send service system status	yes
2	SCMD	send stored telecommand buffer section	yes
3	SASV	Send allocated science data volume	not used
4	SRDY	Science data ready	yes
5	SBUS	Send allocated backup RAM buffer size	yes
6	WRBF	Write backup RAM buffer record	yes
7	RDBF	Read backup RAM buffer record	yes
8	STRG	Pass trigger word	not used
9	FLSP	Flush last science data packet	yes

ROSETTA LANDER ÇIVA & ROLIS IME	Acceptance Data Package		
RO-LRS-ADP-3304	Issue 2.1	Model: FM	

5.7 CALIBRATION DATA

N/A for the IME.

6 UNIT LEVEL VERIFICATION

The guideline for the IME tests and verifications was the « ROLIS-IME Design Verification Requirements – PFM / FM /FS » [RO-LRS-TS 4450]. This document is included in this ADP in **annex 7**.

6.1 TEST MATRIX

Test	Object under test	Conditions	Report reference	Date	Remarks
Thermal test and CDPU cube contact conductivity	DPU/C with mechanical cube	50 cycles : -50, +60 °C speed 10°C/mn	LCIE n°24041010	07/08/00	OK
Vibration	DPU/C	Qualification levels	IAS Orsay	12/09/00	OK
CDPU cube contact conductivity	DPU/C		LCIE n°2562201	06/10/00	OK
Vibration	FM1-RolisDPU ; MEM	Acceptance levels	RO-LRS-TR 4422 (AO ADP IME-FM)	22/11/00	OK
Thermal test	FM-RolisDPU; MEM; (IME1c)	2 cycles+70°C/7h -60°C/5h	RO-LRS-TR 4474/1 (AO ROLIS XV)	8-10/11/00	OK
EMC ^(a)	ÇIVA-CE /EM ROLIS /PFM		CNES Toulouse	04-06/12/00	
Thermal vacuum test	FM-RolisDPU; MEM; (IME1c)	Acceptance levels	RO-LRS-TR 4371 (Annex 14)	6-11/12/00	OK
Vibration	ÇIVA-CE /QM	Qualification levels	LCI-RP-052-3118-IAS	23-26/02/01	OK
Vibration	ÇIVA-CE /FM1	Acceptance levels	LCI-RP-052-3119-IAS	27/03/01	OK
Thermal vacuum test	IME /FM1	Qualification levels	LCI-RP-052-3116-IAS 06/04/01 (AO ADP IME-FM)	30/03/01 to 06/04/01	OK
EMC	IME /FM1	Acceptance	ITS Toulouse; E.03337 (AO ADP IME-FM)	09-10/04/01	OK

ROSETTA LANDER ÇIVA & ROLIS IME	Acceptance Data Package	
RO-LRS-ADP-3304	Issue 2.1	Model: FM

Test	Object under test	Conditions	Report reference	Date	Remarks
Vibration	FM2-RolisDPU	Acceptance levels	DLR-MDT-023-01 (AO ADP IME-FM)	07.05.2001	OK
EMC	IME /FM1* (b)	Acceptance	ITS Toulouse; E.03402 (AO ADP IME-FM)	14-15/05/01	OK
Thermal vacuum test	IME /FM1* (b)	Acceptance levels	LCI-IE-041-3120-IAS and RO-LRS-TR-4381 (AO ADP IME-FM)	17-18/05/01	OK

(a) Refer to EMC tests procedure A. Soufflot, 30 November 2000 (see **annex 13** § 11.13).

(b) IME /FM1* means IME /FM1 with RolisDPU /FM2.

The general difference of the IME testing in comparison with the ROLIS-D CH testing is that the IME is not a stand-alone test object. The test requirements are defined only for the whole CEB, where the IME is only one of the CEB constituents [cf. RolisIME Design Verification Document attached in **annex 7** § 11.7]. This is marginal, due to the mechanical interfaces, especially for the vibration and shock tests.

The test procedures for the Thermal vacuum test and Vibration test are described in the “RolisIME Design Verification Document” [RO-LRS-TS-4450]. This document is included in the ADP as attached Document in **annex 7** § 11.7.

For test procedure “Grounding, Bonding, Insulation” see attached Document in **annex 8** § 11.8.

6.2 INSPECTION REPORTS

Remarks regarding the visual inspection are included in the LOG-Books of the corresponding component.

6.3 QUALIFICATION TEST REPORTS

No tests on qualification vibration levels have been carried out on the ÇIVA / ROLIS IME. Qualification test reports for the ÇIVA / ROLIS IME are compiled in **Annex 14** §11.14.

Table 6.3: Qualification test reports

Test	Object under test	Report reference	Date
Thermal test and CDPU cube contact conductivity	DPU/C with mechanical cube	LCIE n°24041010	07/08/00
Vibration	DPU/C	IAS Orsay	12/09/00
CDPU cube contact conductivity	DPU/C	LCIE n°2562201	06/10/00

ROSETTA LANDER ÇIVA & ROLIS IME	Acceptance Data Package	
RO-LRS-ADP-3304	Issue 2.1	Model: FM

Test	Object under test	Report reference	Date
EMC ^(a)	ÇIVA-CE EM ROLIS PFM	CNES Toulouse	04-06/12/00
Vibration	ÇIVA-CE QM	LCI-RP-052-3118-IAS	23-26/02/01
Thermal vacuum test	IME FM1	LCI-RP-052-3116-IAS	30/03/01 to 06/04/01
EMC (Conductive emission and susceptibility)	IME FM1	ITS Toulouse; E.03337 (AO ADP IME-FM)	09-10/04/00

(a) Refer to EMC tests procedure A. Soufflot, 30 November 2000 (see **annex 13**).

ROSETTA LANDER ÇIVA & ROLIS IME	Acceptance Data Package		
RO-LRS-ADP-3304	Issue 2.1	Model: FM	

6.4 ACCEPTANCE TEST REPORTS

Acceptance test reports are summarized in Table 6.4.

Table 6.4: Acceptance test reports for the RolisIME (FM)

Test	Object under test	Report reference	Date
Vibration	FM1-RolisDPU ; MEM	RO-LRS-TR 4422 (AO ADP IME-FM)	22.11.2000
Vibration	FM2-RolisDPU	DLR-MDT-023-01 (AO ADP IME-FM)	07.05.2001
Vibration	ÇIVA-CE /FM1	LCI-RP-052-3119-IAS	27/03/01
EMC	IME /FM1	ITS Toulouse; E.03337 (AO ADP IME-FM)	09-10/04/01
EMC	IME /FM1* (b)	ITS Toulouse; E.03402 (AO ADP IME-FM)	14-15/05/01
Thermal vacuum test	IME /FM1* (b)	LCI-IE-041-3116-IAS and RO-LRS-TR-4381 (AO ADP IME-FM)	17-18/05/01

(b) IME /FM1* means IME /FM1 with RolisDPU /FM2.

The EMC- and TV- test reports for the complete FM-IME are compiled in **Annex 14**.

6.5 CERTIFICATES

In the IME no materials used, which would need safety certificates.

6.6 CLOSE-OUT PHOTOS

Figure 6.6-1: RolisDPU [ROLIS 2-01F]

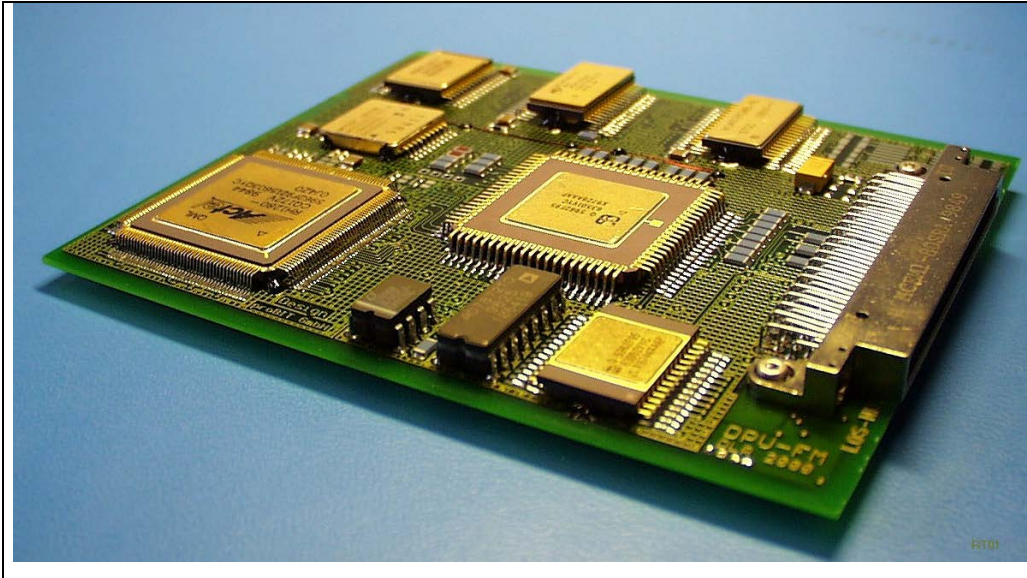

Figure 6.6-2: MEM [ROLIS 2-02F]

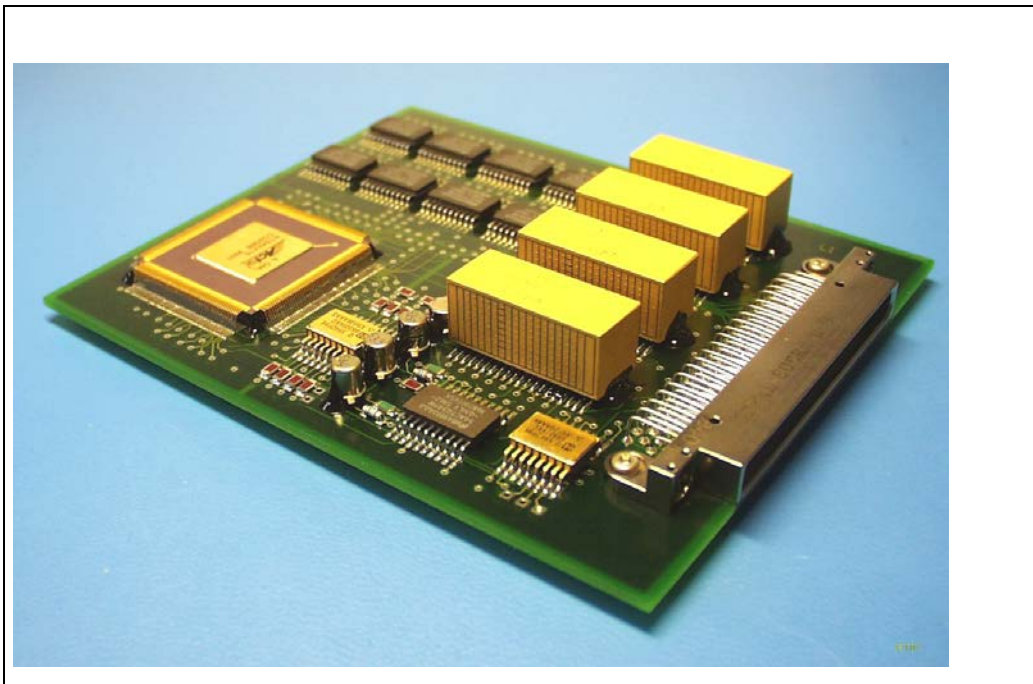

Figure 6.6-3: IME BackPlane [IME 2-04F] before integration into PIF [IME 2-00F]



Figure 6.6-4: CivaDPU [OT 32]

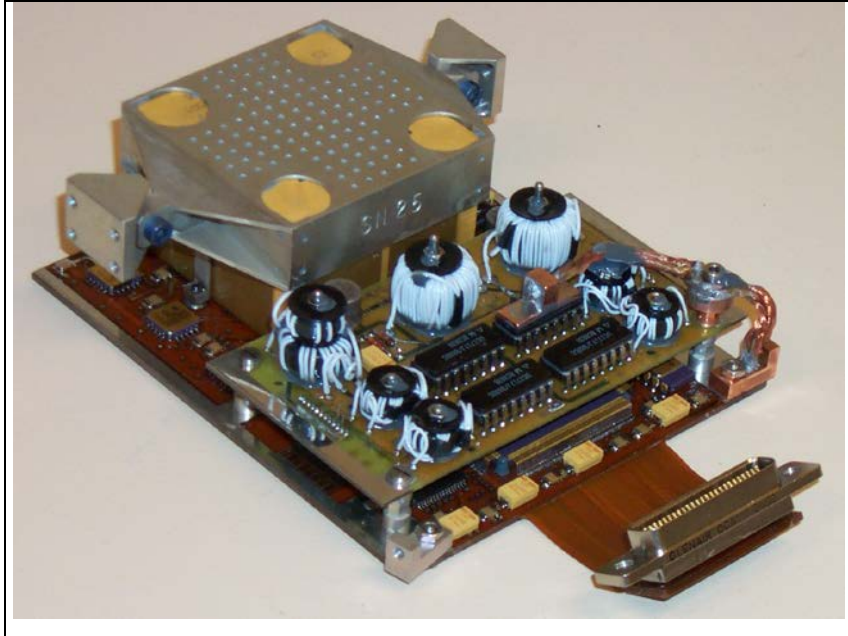

Figure 6.6-5: CivaMID [OT 31]

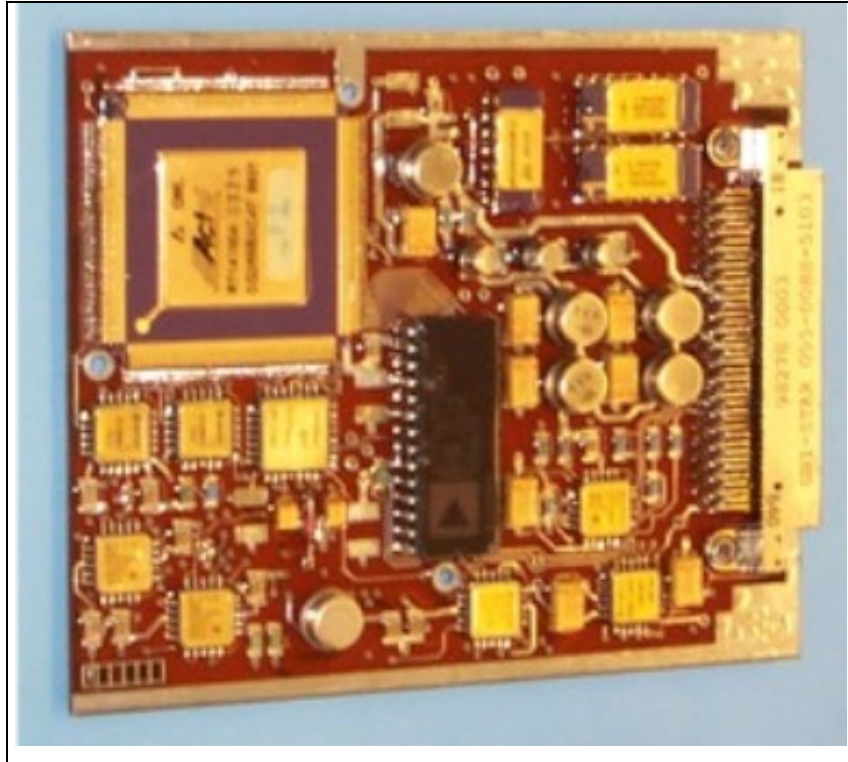
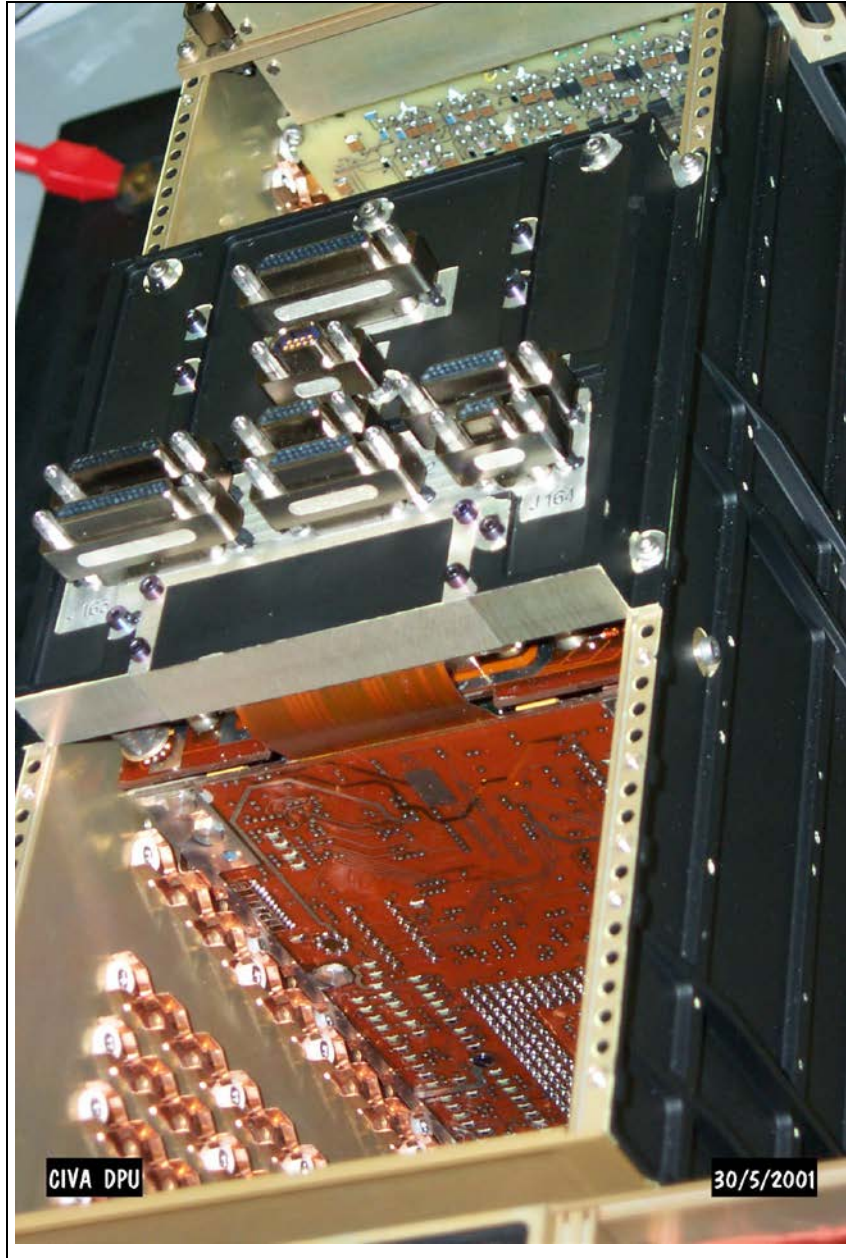

Figure 6.6-6: IME complete [IME 2F]



ROSETTA LANDER ÇIVA & ROLIS IME	Acceptance Data Package	
RO-LRS-ADP-3304	Issue 2.1	Model: FM

7 TEST DEFINITION

7.1 BENCH TEST PROCEDURE

Refer to document « IME Bench test procedure – End to end functional test (EEFT) »

Ref. LCI-IE-041-3116-IAS Ed.1 Rev.1 13-Aug-2001 (see **annex 13** § 11.13).

The Bench Test set-up is described in Sect. 8.3.3.

7.2 LIMITED FUNCTIONAL TEST DEFINITION

The Limited Functional Test Procedure of (integrated) IME controlled by CDMS is defined as so-named Functional Test 10 (RO-LRS-TP 4310) and contains all test items concerning the RolisIME including the CDMS interface. The FT 10 is included in the ADP as attached Document in **Annex 10**.

An other, also limited functional test procedure is described in the test procedure FT#RDGP, as part of the “ÇIVA S/W upload and verification procedures” (cf. **Annex 10.4** and the attached document file ECRupload.civ_150302b.doc).

7.3 FULL FUNCTIONAL TEST DEFINITION

The Full Functional Test of the IME includes the following test stages:

1. ComDPU modes (DEBUG-commands)
2. RolisDPU modes (ROLIS-commands)
3. CivaDPU –ON and ÇIVA -heating modes
4. RolisD camera modes
5. ÇIVA -P camera modes
6. ÇIVA –P/stereo modes
7. ÇIVA -MV modes
8. ÇIVA -MI modes

The tests are to performed at nominal voltages.

The Bench test procedure is applicable. Additions are possible.

7.4 SPECIAL FUNCTIONAL TEST DEFINITION

ROSETTA LANDER ÇIVA & ROLIS IME	Acceptance Data Package	
RO-LRS-ADP-3304	Issue 2.1	Model: FM

The test procedure for testing of the TOUCH-DOWN signal of the integrated IME is defined in the “Limited Functional Test Procedure for Lander Touch-down test” (FT TD#RD) [RO-LRS-TP 4314]. The FT TD#RD is included in the ADP as attached Document in **Annex 10**.

The test procedure for testing of the RolisIME incl. RolisD after software-upload is defined in the “ROLIS S/W upload and verification procedure” [cf. Sect.8.2.4 and **Annex 10**].

The test procedure for testing of the CivaDPU incl. ÇIVA-P, ÇIVA-M/V and ÇIVA-M/I after software-upload is defined in the “CIVA S/W upload and verification procedure” [cf. Sect.8.2.5 and **Annex 10**].

Other special tests are mainly dedicated to the verification of RolisD, CivaP or CivaM/V and described in their ADPs.

8 Operation

8.1 HANDLING, TRANSPORT, STORAGE, AND INSTALLATION PROCEDURE

8.1.1 Handling, transport and storage

The GRM of the ÇIVA / ROLIS IME including all accessories is delivered in a transportation container with the parts according to tables 1.4-1 and 1.4-2 sealed in separate dust tight plastic bags labelled by their part numbers which are also given in the tables. **These bags shall be opened only under clean room conditions (class 100 000)** immediately before installation on the Rosetta Lander GRM.

Storage of the ÇIVA / ROLIS IME GRM (before installation) shall only be done in the transportation container in a clean and dry (50 to 70% humidity) environment, at temperatures of +15 to +25°C. The correct orientation of the container during storage is marked on its outside.

Shocks during transportation and handling must be avoided.

8.1.2 Installation procedure

The installation procedure consists of the following consecutive steps :

1. ÇIVA-DPU board mounting in slot #5
 - a. Verify positions of the two feet, axes are not concentric
 - b. Verify locking screws are UNLOCKED (both feet)
 - foot \cong holding support for the cube
 - c. Verify nut on mounting foot is NOT FIXED (free to rotate)
 - d. Insert DPU boards into guides, until mounting holes for side holding support are aligned with holes in box
 - e. Screws (not tightened) in the side (4 x M2,5 x 2 side)
 - Screws (not tightened) the holding support for the cube (2 x M3)

ROSETTA LANDER ÇIVA & ROLIS IME	Acceptance Data Package	
RO-LRS-ADP-3304	Issue 2.1	Model: FM

- f. Tighten screws in sequence to avoid producing any stress on CUBE
 - Torque : 0,25 mN (for 8 screws M2,5)
 - 1,70 mN (for 2 screws M3)
 - + glue for FM box
- g. Tighten the holding feet at top of board need 5 mm spanner (open end wrench)
 - Nota : need access on -Z side for spanner
2. Other boards mounting on PIF (Plug In Frame)
 - a. ROLIS MEM
 - b. ROLIS DPU
 - c. ÇIVA MID
 - Nota : handle on edges only, with precaution for FPGA boards
3. Integrate PIF + Boards into box
 - Precaution : guide boards along sides flexible

ROSETTA LANDER ÇIVA & ROLIS IME	Acceptance Data Package	
RO-LRS-ADP-3304	Issue 2.1	Model: FM

8.1.3 Disintegration procedure

The disintegration procedure consists of the following consecutive steps :

1. ÇIVA-DPU Demating
 - a. Loosen the 8 x M2,5 screws of the CUBE holding support
 - b. Loosen the 2x locking nuts of upper supports
 - c. Loosen the 2x locking screws on CUBE holding support
 - d. Remove 2 x M2,5 screws of upper supports
 - e. Remove 8 x M2,5 screws of the CUBE holding support
2. PIF disintegration

8.2 OPERATIONAL CONSTRAINTS AND INSTRUCTIONS FOR OPERATING

8.2.1 General Operational constraints

The ÇIVA / ROLIS IME needs to be supplied in the voltage range, listed in table 2.4.1-2, even during maximum of power consumption (cf. table 4.1).

For execution of the telecommands the time between the commands has to be kept.

8.2.2 Operational constraints of the power switch commands

Using the Tcmd 5004 “Power switch” one should strongly pay attention to the status of all power switches!

For example the Tcmd 5004 0008 will not only switch on the CivaP Heaters, but also switch OFF RolisD and/or CivaDPU! The Tcmd 5004 000A will switch on the CivaP Heaters, while the CivaDPU remains switched on (or will be switched on additionally if it was off).

In order to avoid such detailed analysis of the status of the power switches the direct power switch commands 5006, 5007 and 5008 should be used instead the Tcmd 5004 after their implementation by ROLIS S/W upload (cf. Table 5.4.6 – ROLIS telecommands).

ROSETTA LANDER ÇIVA & ROLIS IME	Acceptance Data Package		
RO-LRS-ADP-3304	Issue 2.1	Model: FM	

8.2.3 ROLIS Tcmd “Config” and the various diagnostic levels

The ROLIS diagnostic levels can be changed by the Tcmd 5021 “config” and can be “frozen” as default by Tcmd 5026 “ConfigSave”; otherwise the changed diagnostic level is valid only up to switch-off of the RolisIME.

The diagnostic level #1 is the standard (flight) diagnostic mode (cf. Tab. 5.4.6).

The following Table 8.2.3 shows, in which diagnostic level, the dedicated status information is generated in form of a special science data frame (“text frame”), while the CivaDiagnostic = OFF (Bit11=0).

The last column shows the additional status information, generated in form of a text frame while the Civa Diagnostic = ON (Bit11=1).

Table 8.2.3: Text frame generation in various ROLIS and CIVA diagnostic levels

	Status	Level_0 Bit13,12=00	Level_1 Bit13,12=01	Level_2 Bit13,12=10	Level_3 Bit13,12=11	
1	Boot ROLIS-S/W	yes	yes	yes	yes	
2	One of the 4 main tasks of Rolis-S/W crashed	yes	yes	yes	yes	
3	Unknown RolisTcmd	yes	yes	yes	yes	
4	CS of RolisTcmd OK, but length of Tcmd NOK	yes	yes	yes	yes	
5	Structure of RolisTcmd NOK, f.i. parameter NOK	yes	yes	yes	yes	
6	CS of RolisTcmd NOK	no	yes	yes	yes	
7	RolisTcmd repeated	no	yes	yes	yes	
8	Logging of received RolisTcmd	no	no	yes	yes	
9	Imaging&processing diagnostic	no	no	no	yes	
						additional CivaDiagOn Bit11=1
11	CS of CivaTcmd NOK	no	yes	yes	yes	yes
12	Logging of telecommands to CivaIME	no	no	yes	yes	yes
13	Civa message buffer overrun	no	no	no	no	yes
14	Modulo100 Civa message counter	no	no	no	no	yes
15	CivaIF clock changed	no	no	no	no	yes
16	Shift detected and repaired	no	no	no	no	yes
17	Shift detector failed	no	no	no	no	Yes
18	Switch off of CivaIME	no	no	no	no	yes
19	Missing or wrong acknowledge from Civa	no	no	no	no	yes

“yes” means this status will be logged in special Science Data Frames (status frames, text frames).

ROSETTA LANDER CIVA & ROLIS IME	Acceptance Data Package	
RO-LRS-ADP-3304	Issue 2.1	Model: FM

8.2.4 ROLIS during touch-down

Before Touch-down ROLIS is working in the DIS mode:

- RolisIME on
- RolisD on
- CivaDPU off

The science data of CivaP separation images and RolisD DIT images from the first phase of descent should be completely transferred to CDMS before the Lander Touch-down. This requirement leads to a min. necessary effective CDMS-transfer rate for the Rolis/Civa data of 4 - 5 frames/s (8 – 10 kbps) for more than 15 minutes during descent.

RolisD is taking continuously images and stores them internally in the RolisIME (DIS-mode).

About the Touch-down event ROLIS will be informed by the **hard-wired Touch-down signal**. If ROLIS does not receive this Touch-down signal it will be informed by a special **CDMS message**, wherein the Service System Status (SST) contains the relevant information about the Touch-down. The last possibility to stop the ROLIS DIS imaging is the receiving of the **immediate Tcmd “DescentStop”**. In any case after information about the Touch-down the ROLIS imaging stops abruptly (switches off RolisD); the RolisIME starts immediately the imaging pre-processing (compression) of 4 dedicated DIS images and tries to transfer it to the CDMS, already when the first frame is ready to telemetry. The RolisIME remains switched on during and after the Touch-down.

The Tcmd “DescentCheck” checks for not pre-processed, raw DIS images. This could be the case after a reset of RolisIME during the Touch-down. The reset would lead to an unfinished descent imaging, which includes the pre-processing and storage in the Rolis/Civa output buffer. In that case the Tcmd “DescentCheck” will pre-process 2 DIS-images (instead of 4 in the nominal case) and transfer them to CDMS. The Tcmd “DescentCheck” will be ignored if the DIS imaging was finished nominally or the including image pre-processing is going on.

8.2.5 ROLIS Tcmd “WaitDataComplete”

The Tcmd “WaitDataComplete” allows to finish a ROLIS / CIVA operation sequence not with a time-tagged Tcmd but with a conditional switch off by waiting until all data are completely sent to CDMS. The Tcmd 50E0 “WaitDataComplete” leads to a periodical polling if all buffered Rolis/Civa imaging data are sent to CDMS. If this is the case, an OCPL service request code will be sent to CDMS for conditional actions like Tcmds, especially the « Rolis/Civa Experiment power off « Tcmd. (cf. Table 5.4.6 – ROLIS telecommands).

8.2.6 ROLIS S/W upload and verification procedure

The complete ROLIS S/W upload and verification procedure will be described by the procedure used for the FM via CDMS in March 2002.

- 1.1. Perform ROLIS software upload by using
telecommand file: Rolis-Upload-FM05a.tcmd
and verify by
science data dump: Rolis-ScienceData-Upload.pdf

The first telecommand should be sent **WITHIN ONE MINUTE** after Rolis/Civa Experiment- power on.

ROSETTA LANDER ÇIVA & ROLIS IME	Acceptance Data Package	
RO-LRS-ADP-3304	Issue 2.1	Model: FM

If the upload is NOT successful, the ROLIS science data frames contain error messages in plain ASCII. In that case the upload should be repeated.

1.2. Perform ROLIS upload verification by using
telecommand file: Rolis-Upload-Verify.tcmd
and verify by
science data dump: Rolis-ScienceData-Verify.pdf

The first telecommand should be sent WITHIN ONE MINUTE after ROLIS-IME power on. This is an additional verification of the software upload. It should be performed after successful step 1.1.

1.3. Perform ROLIS software configuration by using
telecommand file: Rolis-Config.tcmd
and verify by
science data dump: Rolis-ScienceData-Config.pdf

The first telecommand should be sent AFTER MORE THAN ONE MINUTE after ROLIS-IME power on (after ROLIS automatic boot). It is necessary to configure the ROLIS software for the ROLIS-D Camera Head (FM). It should be performed after successful step 1.2.

1.4. Perform Short ROLIS-D Test by using
telecommand file: ShortTest.tcmd
and verify by
LOG-file: 2002mar12_1322-ShortTest.log

The first telecommand should be sent AFTER MORE THAN ONE MINUTE after ROLIS-IME power on (after ROLIS automatic boot). It is necessary to check shortly the ROLIS-D Camera Head (FM) after ROLIS software upload functionally. It should be performed after successful step 1.3.

-> cf. the attached files in Annex 10.3.

8.2.7 ÇIVA S/W upload and verification procedures

The upload procedure is described in the document / file ECRupload.civ_150302b.pdf (cf. **Annex 10.4**).

The ÇIVA S/W upload has to be verified on the basis of the ÇIVA-P, ÇIVA-M/V and ÇIVA-M/I test procedures described also in the above mentioned file ECRupload.civ_150302b.pdf

The first ÇIVA telecommand should be sent AFTER MORE THAN ONE MINUTE after ROLIS power on (after ROLIS automatic boot) !

ROSETTA LANDER ÇIVA & ROLIS IME	Acceptance Data Package		
RO-LRS-ADP-3304	Issue 2.1	Model: FM	

8.2.8 HK interpretation according timeline

The CDMS is asking each 2s for a dedicated HK value.

1st HK-block contains HK values generated in the RolisIME 4min16sec⁵ before.

2nd HK-block contains HK values generated in the RolisIME 2min08sec before.

The first HK values after switching-on of the IME are loaded into the RolisIME HK-BufferOUT already during the boot process.

Example:

If the CDMS is asking for HK#127 @ OBT 0:04:16, the ROLIS-S/W will

0. Send HK#127 of the HK BufferOUT to CDMS as the last HK-value of this HK-block, obtained @ OBT 0:02:08
1. Copy all RolisSW-HK and Civa-HK from the HK-BufferIN to the HK-BufferOUT
2. Measure the 16 Rolis/Civa Analog-HK values and write them directly into the HK-BufferOUT
3. Send a info-message to the CivaDPU with the meaning “ now the last HK-values from the HK BufferIN have been copied to the HK-BufferOUT and will be sent to CDMS”
4. at any time the CivaDPU has the possibility asynchronously to update the Civa-HK values in the HK-BufferIN of the RolisDPU by sending dedicated HK-messages.

If the CDMS is asking for next HK#0 @ OBT 0:04:18, the CDMS will get the already prepared HK-value of the HK-BufferOUT and so on.

If the CDMS is asking for HK#63 @ OBT 0:06:24, the CDMS will get the last HK-value of the HK-BufferOUT, prepared @ OBT 0:04:16.

And the RolisSW will again perform the steps 1 – 4.

Conclusion:

HK-frame with OBT 0:08:32 contains

- 1st HK-block with Rolis/CivaHW-HK values, measured at OBT 0:04:16, with RolisSW-HK valid for OBT 0:04:16 and with Civa-HK valid for OBT between 0:02:08 - 0:04:16, depending on when the last updates were transferred by CivaDPU to the HK-BufferIN of RolisDPU.
- 2nd HK-block with Rolis/CivaHW-HK values, measured at OBT 0:06:24, with RolisSW-HK valid for OBT 0:06:24 and with Civa-HK valid for OBT between 0:04:16 - 0:06:24, depending on when last updates were transferred by CivaDPU to the HK-BufferIN of RolisDPU.

8.2.9 Timing details of measuring of the 16 Rolis/CivaHW-HK values

The Civa Analog-HK as well as the ROLIS Analog-HK will be sampled in the moments described before. The multiplexor provides to the ADC each 50 μ s the next HK. The AD-conversion time is $\sim 8 \mu$ s. That means the time difference between one HK to the next is $\sim 58 \mu$ s; from the first HK#0 (internal temperature of RolisD) to HK#14 (current of +5.2V power line, consumed by ÇIVA / ROLIS / IME) the difference is accordingly $\sim 812 \mu$ s. In less than 1ms all 16 Rolis/CivaHW-HK values will be converted and stored in the HK BufferOUT.

⁵ in reality Lander test results show deviations from 2min:08sec (fixed by OBT)

ROSETTA LANDER ÇIVA & ROLIS IME	Acceptance Data Package		
RO-LRS-ADP-3304	Issue 2.1	Model: FM	

8.2.10 Rolis / Civa text frames in the data stream

Rolis Text frames (Rolis data frames Type#0) are not accumulated in a buffer, but are transferred immediately to the CDMS after the transfer of the actual data frame is completed (cf. Fig.8.2.-1).

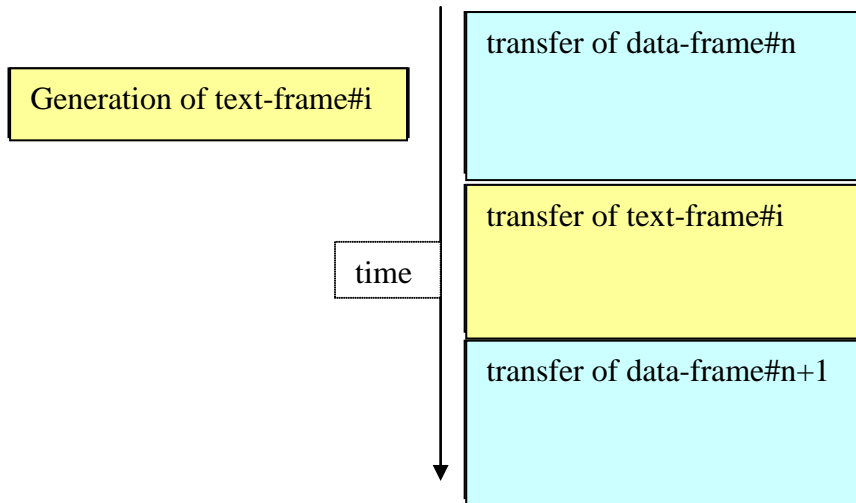

Figure 8.2.-1: frame transfer sequence with text frame

This is done intentionally to have text/debug output in “real-time” while large science data volumes may be sent with sufficient delay due to buffering.

This may be an issue, if the CDMS does not serve science data requests (e.g. during Lander descent).

Then the sending of a text frame leads to the following behaviour:

1. Wait max. 5 seconds until the current science data frame was sent.
2. If the output to CDMS is stopped longer, then the text frame will be discarded, delaying the current imaging process by the mentioned 5 seconds.

Depending on the diagnostic level configuration (cf. Text frame generation in various ROLIS and CIVA diagnostic levels in Table 8.2.3) the cases generating a text-frame can be modified. Moreover the generation of text-frames can be cancelled generally by setting the bit15 of the configuration-flag = 0 (cf. Tcmd 5021 in Table 5.4.6). But this would lead to a lost of any status information.

8.2.11 ROLIS image data and ISB

Together with ROLIS imaging data an Imaging Status Block (ISB) will be send

- after the telecommand “SendISB” (Tcmd=504B)
- after transfer of a “CloseupImg” (Tcmd=5051) to the CDMS
- before transfer of all DIS-images (Tcmd=5054; 5055 or 5058 and after touch-down)
- before transfer of a “DarkRef”-image (Tcmd=5060)
- before transfer of a “Full Image” (Tcmd=5061).

ROSETTA LANDER ÇIVA & ROLIS IME	Acceptance Data Package	
RO-LRS-ADP-3304	Issue 2.1	Model: FM

8.3 GSE SPECIFICATION

8.3.1 Bench Test Configuration

The complete ROLIS-EGSE (ROLIS 3F) is applicable for the FM-, FS-, and GRM-models and consists of the components described in Tab. 8.3.1.

Table 8.3.1: ROLIS-EGSE components

No.	Description	Part. No.(Subunit)	Remarks
1	EGSE ComDPU	ROLIS 3-01P-1	
2	EGSE MEM	ROLIS 3-02P-1	
3	EGSE PIF	ROLIS 3-00P-1	
4	CH Simulator	ROLIS 3-05F-1	
5	Test cable	ROLIS 3-15F-1	
6	test adapter	ROLIS 3-06P-1	
7	(Standard) Lab Power Supply	ROLIS 3-07E-1	HP E3631A
8	(Standard) Lab Power Supply	ROLIS 3-07E-2	HP E3631A
9	(Standard) Lab Power Supply	ROLIS 3-07P-1	HP E3632A
10	EGSE-PC (Test Control Computer)	ROLIS 3-08E-1	Laptop REGSE 1
11	CDMS-Simulator	ROLIS 3-09E-1	

In the IME Bench Test the EGSE items 1, 2 and 3 are replaced by the Device Under Test (DUT): the IME (IME 2x⁶) itself.

For complete testing including the CIVA components the CivaDPU (CIVA 2-08x-1) and the CivaMID (CIVA 2.09x-1) have to be added (cf. Fig. 8.3-1).

8.3.2 EGSE Functionality and Integrated IME Tests

As incoming tests have to be proceeded a Bench Test and an Integrated IME Test. The EGSE PC is used in the Bench Test to send telecommands and to receive the telemetry data. The received telemetry data are displayed on the monitor and stored in files with automatically generated file names.

After the IME Integration the Full Functional Test has to be performed with Lander test facilities, without EGSE, which does not remain on the Lander test site after successful integration of the IME.

⁶ x stands for G (GRM) or F (FM) respectively

8.3.3 Bench test set-up

The connection scheme of bench test assembly is shown in figure 8.3.3.

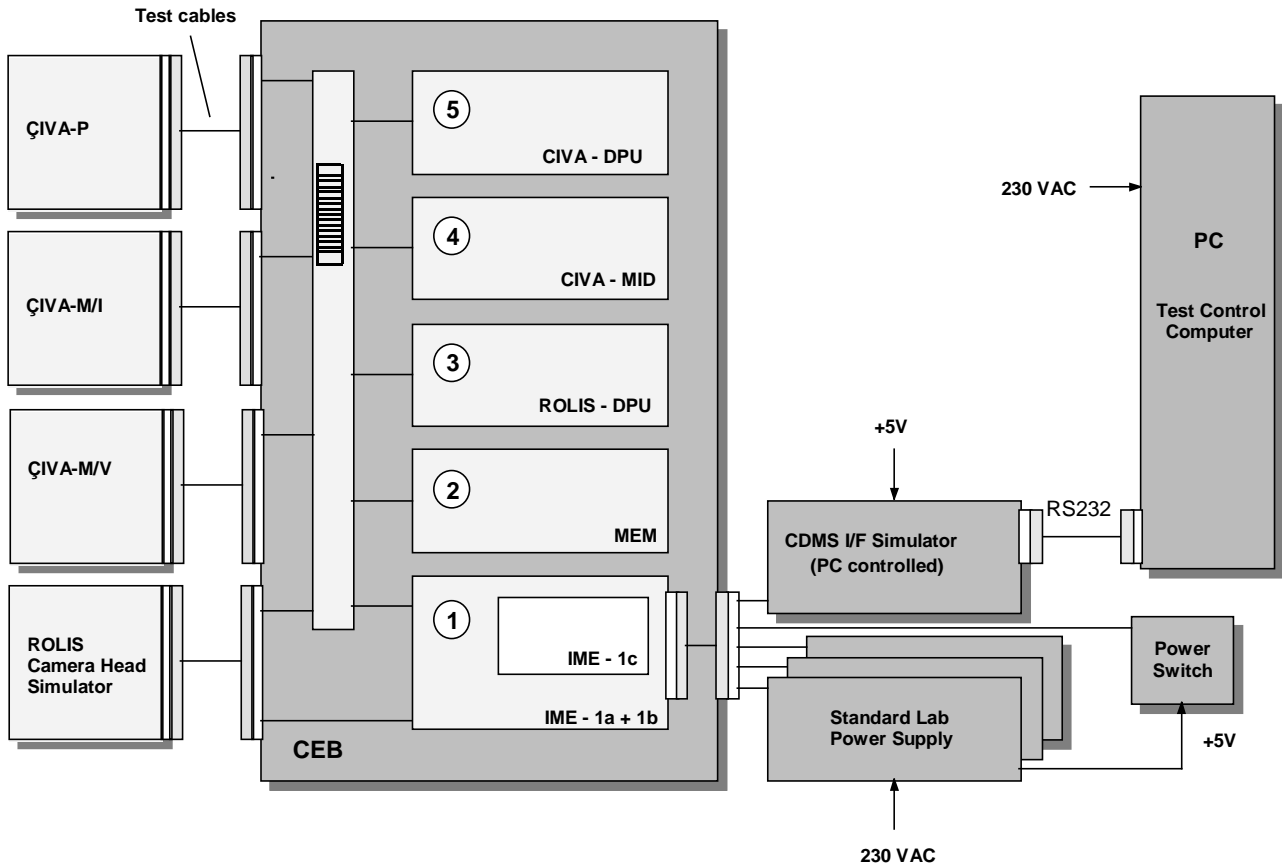

Figure 8.3.3: Connection scheme of bench test assembly

8.3.4 GSE computer set-up

Used test software:

	Name	Vers. No.	date	Item
1	Windows 95; Windows 98, Windows NT, Windows 2000 or Windows XP			
2	EGSE (Test-) Software: CDMS.EXE	Vers. 6. 42	04. Dec. 2001	ROLIS 3-04F

ROSETTA LANDER ÇIVA & ROLIS IME	Acceptance Data Package	
RO-LRS-ADP-3304	Issue 2.1	Model: FM

8.4 MAINTENANCE HANDBOOK

N/A.

8.5 LOGBOOK/HISTORICAL RECORD CARD

The Logbooks are included in the ADP as **Annex 16.4**.

8.6 MATING/DEMATING LOG

The Mating/Demating Log is documented in the Logbooks for the IME and its components.
[cf. **Annex 16.4**].

9 PRODUCT ASSURANCE DATA

The Product Assurance Plan is referenced “LCI-GO-1-3085-IAS”.

9.1 DECLARED MATERIALS LIST

Declared materials list can be found in **annex 2**.

9.2 DECLARED MECHANICAL PARTS LIST

Declared mechanical parts list can be found in **annex 2**.

9.3 DECLARED PROCESSES LIST

Declared processes list can be found in **annex 3**.

9.4 DECLARED EEE-PARTS LIST

Declared EEE parts list can be found in **annex 4** .

9.5 EEE-PARTS APPLICATION LIST

Refer to §9.4 “Declared EEE-parts list”.

ROSETTA LANDER ÇIVA & ROLIS IME	Acceptance Data Package	
RO-LRS-ADP-3304	Issue 2.1	Model: FM

9.6 SAFETY DATA

N/A.

There are no pressure vessels or systems, no pyrotechnics actuators, no radioactive materials, no moving parts, no toxic materials and no high voltages within ROLIS/ÇIVA IME.

9.7 CLEANLINESS CERTIFICATE

N/A.

ROSETTA LANDER ÇIVA & ROLIS IME	Acceptance Data Package	
RO-LRS-ADP-3304	Issue 2.1	Model: FM

10 CONFIGURATION CONTROL

10.1 CONFIGURATION ITEMS DATA LIST / CIDL

The CIDL of RolisIME is a part of the common CIDL of RolisD /RolisIME and is included also in this ADP in **Annex 11**.

10.2 LIST OF NON CONFORMANCE REPORTS (NCR)

List of Non-Conformances / Non-Conformance Reports							
ÇIVA / ROLIS IME				Prepared by:			
Error report No.	Model	Subunit / integration step	Serial-No.	Non-conformance (short description)	Date	Action / remarks	Date of fixing/ Status
RO-ComDPU- NC-001- DLR/BA				Low-power state of ComDPU		Rework by DLR/BA (cf. LogBook of RolisDPU: RO- LRS-RP 4411/2)	closed
LCI-FA-053- 3111-IAS				Contact failure between 1a / 1b-boards of ExpIF		Rework by MP Ae (cf. LogBook of PIF: RO-LRS- RP 4430/3)	closed
LCI-FA-053- 3112-IAS				Voltage drop on +5.2V-power line		Rework by DLR/BA and MP Ae (cf. LogBook of PIF: RO-LRS- RP 4430/3)	closed
RO-LAN-NC- 32181				ROLIS harness routing		Cf. W215 Cable-Spec RO-LRS-SP 5615*	closed

ROSETTA LANDER ÇIVA & ROLIS IME	Acceptance Data Package	
RO-LRS-ADP-3304	Issue 2.1	Model: FM

RO-LCI-DM-054-3107-IAS				Exchange rate between ROLIS and ÇIVA		Implemented by DLR/BA (ROLIS-S/W)	closed

* The W215 Cable-Spec (RO-LRS-SP 5615) is included in the ADP as attached Document in **Annex 12** § 11.12.

10.3 LIST OF WAIVER AND ECR REQUESTS

Waver-code	Short Description	Status for IME (FM)	
RO-LRS-W 01	TV-test on PFM-level	Considered	Test on PFM-level performed (4 cycles) (cf. TestReport: 6/4/01)