





ITP for Herschel FM TB/TV

Herschel

Title: **Integrated Test Procedure  
for the Herschel FM TB/TV Test**

CI-No: 100 000

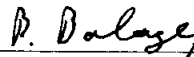
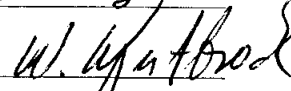
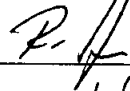
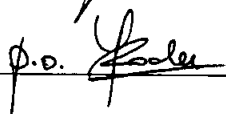
Prepared by:	G. Jahn		Date:	15.11.2008
Checked by:	J. Kroeker			17. 11. 2008
Product Assurance:	for R. Stritter			16. 11. 2008
Configuration Control:	W. Wietbrock			17/11/2008
Project Management:	W. Fricke			16.11.08
TAS-F Approval:	D. Montet			16 NOV 08
Distribution:	See Distribution List (last page)			

Copying of this document, and giving it to others and the use or communication of the contents there-of, are forbidden without express authority. Offenders are liable to the payment of damages. All rights are reserved in the event of the grant of a patent or the registration of a utility model or design.

Issue	Date	Sheet	Description of Change	Release
Draft 1	11.01.08	All	First Issue	
Draft 2	07.08.08	All	Update for Spec Iss. 4 (to be issued)	
Draft 4	31.10.08		ETS comments on Draft 2 (received by mail on 09.08.08) implemented in AD list, TP-A and TP-L  TAS-F comments implemented: New AD24 H.1.2 SVM TCS heater lines table updated  ESA comments implemented: 5.1 TMM correlation deleted H1.1 PPS tilting 1° above immersion value TP-A Max tilt angle determined by tilting test TP-B Global leak test setup check introduced TP-K SOVT2 introduced Global leak measurements introduced TP-L IST replaced by SFT2  General: Wording updates Updates due to Test Spec Iss.5 changes	
Draft 6	05.11.08	Annex C Annex I TP-A TP-B TP-K	Test heater list introduced Loading of alarm limits defined Expected timing for LSS preparation included VG measurement after LSS 5m door closure HIFI in Standby during SVM TB cold TV Hot sequence refined in ITP TT&C test call from ITP introduced	
1	07.11.08	Annex A Annex I TP-G TP-H	Warning and alarm limit list included SVM test heater settings according to [AD25] SVM TCS go-ahead required before cooler recycling in SVM TB Ensure that S/C is vertical before starting HIFI SFTs	
1.1	15.11.08	Annex H Annex I TP-B	IR rig heaters setpoint for mode C deleted Update of references for cryo SCOE operations Several typos corrected (SVM alarm limits, valves) Wording updated for clarification Expected duration of SVM TV cold 64 hrs, was 48 hrs. Overlap of SVM TV cold into PLM Rapid Cool-down introduced and no	

Issue	Date	Sheet	Description of Change	Release
			<p>waiting period before SVM TV cold.</p> <p>No tilt angle change during HIFI SFT in SVM TV cold</p> <p>Global Leak Test setup check with calibrated leak advanced to after LSS cool-down</p> <p>Loading of SVM TCTs already included in function procedure but explicitly mentioned in ITP</p> <p>SVM TB cold: change of test heater settings for TS#4e as specified changed to modification of TCT tables on TAS-F request</p> <p>TP-C Load SVM TCT 5</p> <p>TP-E Enable TCS FDIR</p> <p>TP-F Correction of UIUs for all HIFI units to be initiated by SVM TCS</p> <p>Disabling of FDIR at end of phase acc. to TAS-F request</p> <p>TP-I PACS TV duration increased from 32 to 40 hrs</p> <p>TP-K Update of Tel decontamination heater sequence and thresholds</p> <p>Loading of TCT 9 (for phase 14o-14w) linked to SVM TV phase 14p instead of Telescope decontamination phase 14o upon TAS-F request</p>	

**Table of Contents**

<b>1</b>	<b>Scope</b>	<b>7</b>
<b>2</b>	<b>Documentation and Abbreviations</b>	<b>8</b>
2.1	Applicable Documents	8
2.2	Reference Documents	9
2.3	Abbreviations	11
<b>3</b>	<b>Requirements to be verified</b>	<b>13</b>
<b>4</b>	<b>Configuration</b>	<b>13</b>
4.1	EGSE configuration	13
<b>5</b>	<b>Test Criteria</b>	<b>16</b>
5.1	Stability Criteria	16
<b>6</b>	<b>Summary Sheets</b>	<b>17</b>
6.1	Non Conformance Report (NCR) Summary	17
6.2	Sign-off Sheet	18
<b>Annex A</b>	<b>Sensor Warning and Alarm Limits</b>	<b>A-1</b>
A.1	TDH Sensor Warning and Alarm Limits	A-1
<b>Annex B</b>	<b>Wiring Lists for TDH Sensors</b>	<b>B-1</b>
B.1	Pt100 Sensors	B-1
B.2	Thermocouples	B-2
<b>Annex C</b>	<b>Verification of Test Heaters</b>	<b>C-1</b>
<b>Annex D</b>	<b>End-of-Phase Reporting</b>	<b>D-1</b>
D.1	TDH Data	D-1
D.2	CCS Data	D-1
D.3	CVSE status	D-1
D.4	Operations / Deviations / NCRs	D-2

<b>Annex E</b>	<b>HACS Integration and Operation Procedure</b>	<b>E-1</b>
E.1	HACS Mechanical Integration	E-1
E.2	HACS electrical Integration	E-1
E.2.1	Light Source Installation	E-1
E.2.2	Control H/W Installation	E-1
E.2.3	Activation	E-1
E.2.4	Adjust Laser and Image Settings	E-1
E.3	Perform Measurements	E-1
E.3.1	Manually	E-1
E.3.2	Automatically	E-1
E.4	Deactivation	E-1
E.5	Operational Constraints	E-1
<b>Annex F</b>	<b>Form Sheets</b>	<b>F-1</b>
<b>Annex G</b>	<b>Helium flow chart and CVSE instrumentation</b>	<b>G-1</b>
<b>Annex H</b>	<b>Data tables</b>	<b>H-1</b>
H.1.1	Tilting Angles for PPS Operation	H-1
H.1.2	SVM TCS heater lines cycling control table	H-1
H.1.3	Test heater settings	H-1
<b>Annex I</b>	<b>Integrated Step-by-Step Procedure</b>	<b>I-1</b>
I.1	Functional tests and S/C preparation	I.1-1
I.2	TP-B – LEOP and SVM Cold	I.2-1
I.2.1	Tilt Angle Adjustment during TP-B - LEOP and SVM Cold	I.2-1
I.3	TP-C – PLM Rapid Cool-Down and SVM heat-up	I.3-1
I.4	TP-D – TV Phase HIFI 0-1	I.4-1
I.5	TP-E – Combined Instruments TV	I.5-1
I.6	TP-F – HIFI TV Test 2	I.6-1
I.7	TP-G – SPIRE TV and SVM TB Hot	I.7-1
I.8	TP-H – HIFI TV Test 3	I.8-1
I.9	TP-I – PACS TV Test	I.9-1
I.10	TP-J – HIFI TV Test 4	I.10-1
I.11	TP-K – SVM TV HOT	I.11-1
I.12	TP-L - Recovery to Ambient	I.12-1

## Table of Figures

Figure 1: Procedure tree .....	10
Figure 2: Instruments checkout area sketch .....	13
Figure 3: LSS test floor sketch .....	15
Figure 4: HACCS installation .....	E-1
Figure 5: Housekeeping Parameters .....	E-1
Figure 6: Measurement View .....	E-1
Figure 7: Graph View .....	E-1

## **1 Scope**

This document contains the integrated test procedure (ITP) for performing the Herschel FM TB/TV test, i.e. a step by step procedure including the activities on the test object as well as on the test facility and data handling side.

It is to be used in combination with the thermal tests leading procedure [AD5] which contains the descriptive part of the test procedure and also gives the relation to other thermal test activities.

## 2 Documentation and Abbreviations

Applicable documents (AD) are defined as being documents which are needed to complete the work, they are considered as being integral part of this document, as far as specifically called-up. In case of contradictions between contents of the applicable documents and the current document, the statements given in the current document supersede the applicable document.

The following documents in their latest issue are applicable to this test procedure:

### 2.1 Applicable Documents

- [AD1] Unit Switching Status, HP-1-ASPI-TN-0386 Iss. 2
- [AD2] Herschel EGSE SAT and Instruments Procedure for the SAT TB/TV Testing, HP-2-ASED-PR-0236
- [AD3] Test Specification for Herschel Instruments FM Tests performed at satellite level, HP-2-ASP-TS-1083 Iss.2
- [AD4] Herschel FM TV/TB Test Specification, H-P-2-ASP-TS-0997 Iss.5
- [AD5] Herschel FM Thermal Test Leading Procedure, HP-2-ASED-TP-0200
- [AD6] Generic Emergency Procedure in case of alarm during a test campaign, HP-2-ETS-PR-0002 Iss.1, ETS/PROC/SAF/00/002
- [AD7] Emergency Shut Down Procedure for ETS operated Test Facilities, HP-2-ETS-PR-0044 Iss.1, ETS/GPRO/MECH/044
- [AD8] Launch Autonomy Test Procedure for FM, HP-2-ASED-TP-0201
- [AD9] HIFI Power on for IST & TV, SRON-G-HIFI-PR-2007-017\_1.5.3
- [AD10] HIFI Step-by-Step Test Procedure for FM TB/TV, SRON-G/HIFI/PR/2007-024, 1.23
- [AD11] HIFI power-up and power-down procedures for IST and TV tests, HP-2-SRON-PR-0029 Iss. 1.8
- [AD12] HIFI mode transitions, HP-2-SRON-PR-0028 Iss. 1.1
- [AD13] PACS Step-by-Step Test Procedure for FM TB/TV PACS-ME-TP-021\_2.8
- [AD14] SPIRE Step-by-Step Test Procedure for FM TB/TV, SPIRE-RAL-PRC-3042, issue 1.0
- [AD15] (deleted)
- [AD16] ATC health check procedure, HP-2-ASED-TP-0211
- [AD17] S/C Transfer and Mechanical Integration in LSS, HP-2-ASED-PR0131
- [AD18] Electrical Integration and Check-Out for TB/TV Test, HP-2-ASED-RP-, tbi
- [AD19] Herschel EGSE Commissioning Procedure, HP-2-ASED-PR-0069
- [AD20] CVSE Set up for FM TV/TB Test, HP-2-ASED-PR-0126



- [AD21] Procedure for HACS Setup and Measurements in LSS, HP-2-TER-MA-0001
- [AD22] Herschel Videogrammetry Test – Scale Bar Installation Procedure, TEC-TCE/2008.42/ACZ/\*/
- [AD23] Videogrammetry System, Hardware/Software Manual, Videogrammetry-TCE-EDO-080808-TN-01-01
- [AD24] MLI / Thermal Test Equipment Setup Procedure, HP-2-ASED-PR-0115
- [AD25] Herschel FM Thermal Test guide line H-P-2-ASP-TN-178 Iss.1
- [AD26] Herschel FM TV/TB Emergency procedures, H-P-2-ASP-TS-1704 iss. 1
- [AD27] Herschel PFM: Helium II Production And Top Up Procedure, HP-2-ASED-TP-0083
- [AD28] TTC Execution test procedure, HP-2-ASED-TP-0245 Iss.1
- [AD29] Herschel SOVT-2 Test Plan, PT-HMOC-OPS-PL-6217-OPS-OAH
- [AD30] Global Leak Test Procedure, MU1H07\_AA Iss.2
- [AD31] Herschel TT&C Health Check, H-P-2-ASP-SP-1652 iss.1

## 2.2 Reference Documents

- [RD1] HACS operation manual
- [RD2] Videogrammetry operation manual
- [RD3] H-EPLM Instrumentation Plan for FM TB/TV Test, HP-2-ASED-PL-0054
- [RD4] Herschel / Planck - Herschel SVM - FM TV/TB Test Thermocouples Location, HP-4-AI-TN-0135\_2

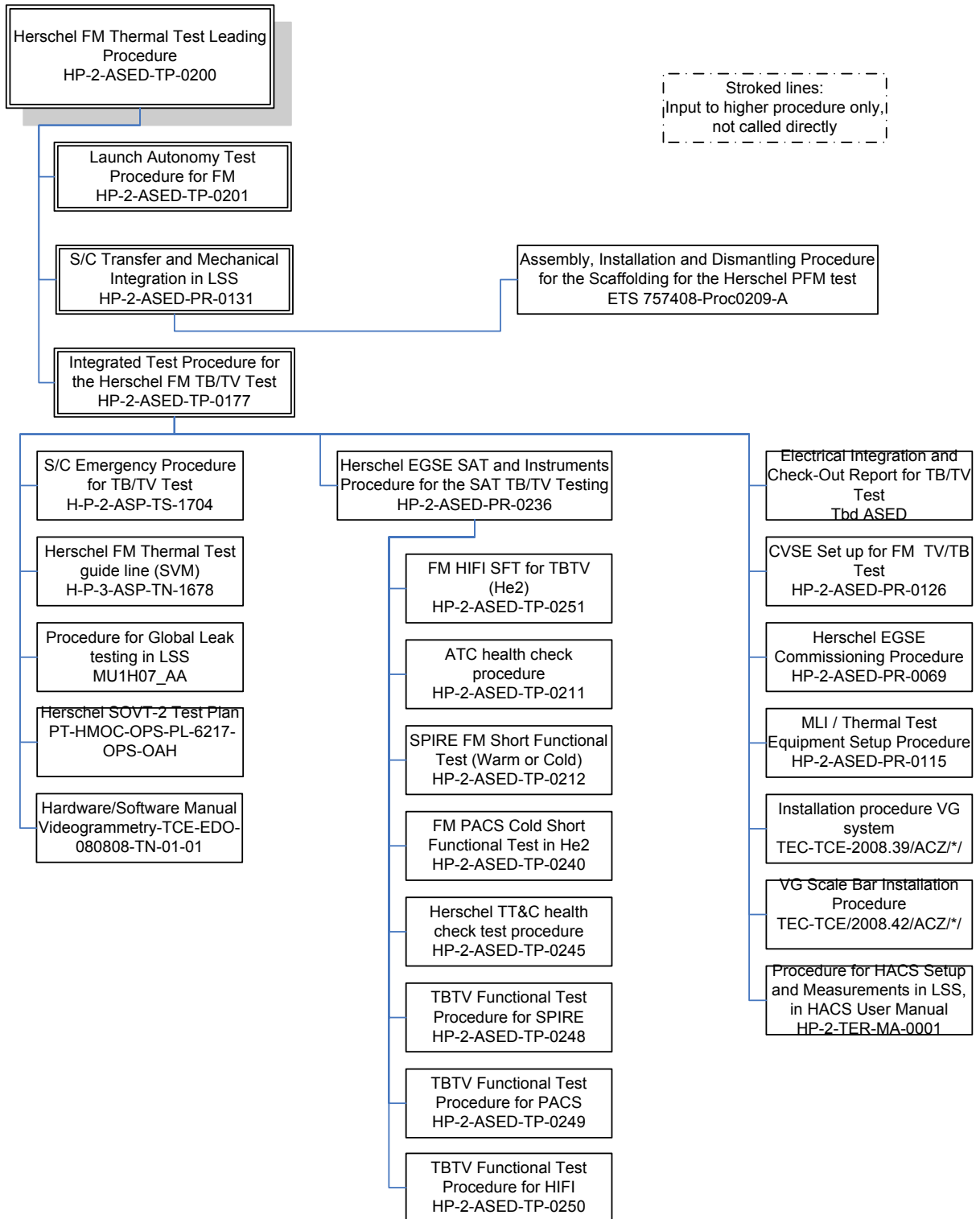

Figure 1: Procedure tree

## 2.3 Abbreviations

AIT	Assembly, Integration and Test
ASED	EADS Astrium ED (Friedrichshafen)
CCS	Central Check-out System
CVSE	Cryo-Vacuum Support Equipment
CVV	Cryostat Vacuum Vessel
DGMM	Detailed Geometrical Mathematical Model
DLCM	Direct Liquid Content Measurement Device
DTMM	Detailed Thermal Mathematical Model
EGSE	Electrical Ground Support Equipment
E-PLM	Extended Payload Module
ETS	European Test Services
FDH	Facility Data Handling
FPU	Focal Plane Unit
GHe	Gaseous Helium
HACS	Herschel Alignment Camera System
He	Helium
HOT	Helium I Tank
HSS	Herschel Sunshield / Solar Generator
HSS-TCR	HSS Thermal Control Rig
HTT	Helium II Tank
HVP	High Vacuum Pump
IR	Infra-red
ITP	Integrated Test Procedure
LAN	Local Area Network
LEOP	Launch and Early Orbit Phase
LHe	Liquid Helium
LN2	Liquid Nitrogen
LOU	Local Oscillator Unit
LSS	Large Space Simulator
NCR	Non-Conformance Report
OBA	Optical Bench Assembly
OBP	Optical Bench Plate
ORS	Operation Request Sheet
PLC	Programmable Logic Controller
PPB	PentaPrism Block
PPS	Passive Phase Separator
PROPOS	Programmable Power Supplies
PTR	Post Test Review
S/C	Spacecraft
SCOE	Special Check-Out Equipment
SIH	Scientific Instrument Harness
SPAD	Specimen Access Device
STM	Structural / Thermal Model

TAS	Thales Alenia Space
TB	Thermal Balance
tbc	to be confirmed
tbd	to be defined
tbi	to be issued
TD	Thermal Dummy
TDH	Thermal Data Handling
TMM	Thermal Mathematical Model
TRB	Test Review Board
TRP	Temperature Reference Point
TRR	Test Readiness Review
TSMU	Transportation Stimuli and Monitoring Unit
TTA	Thermal Test Adapter
TV	Thermal Vacuum
TVQM3	Test Valve (LHV Qualification Model 3)
VDG	Videogrammetry
VTF	Vacuum Feed-Through
VLD	Vertical Lifting Device
VSS	Vertical Support Stand

### 3 Requirements to be verified

Refer to section 1.2 of [AD4]

### 4 Configuration

The specimen configuration is described in the thermal tests leading procedure, refer to [AD5].

#### 4.1 EGSE configuration

##### Instruments checkout

The instruments checkout area is located in room FR001.

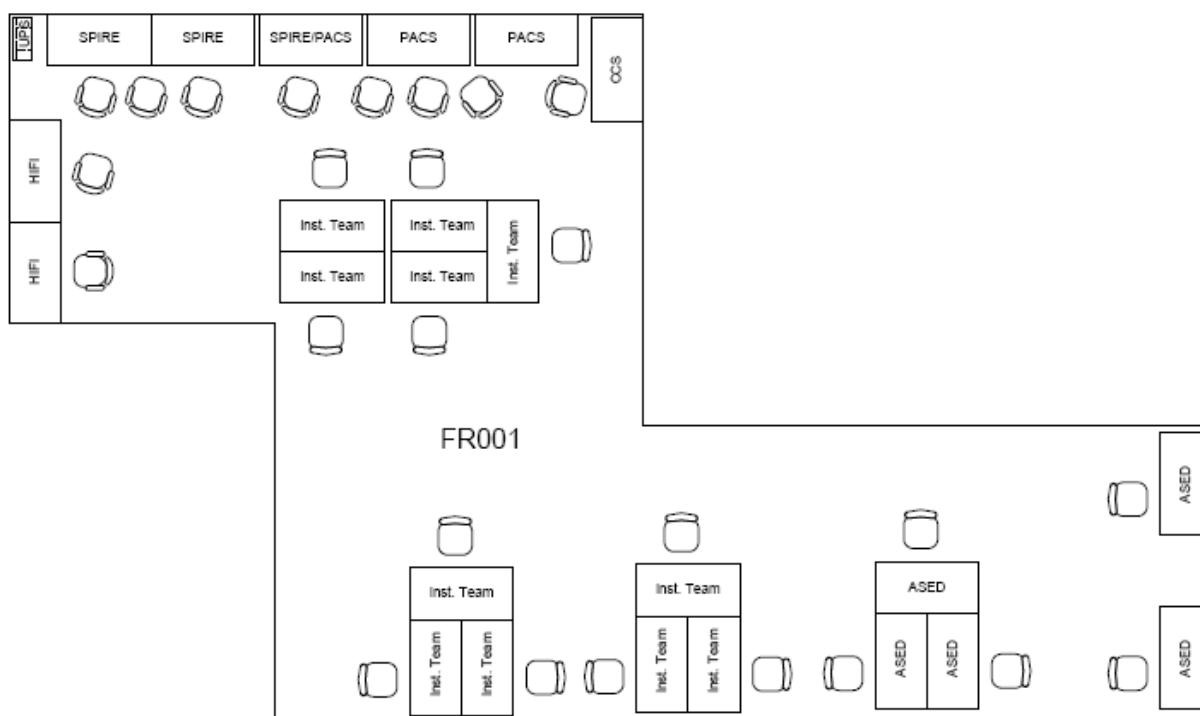

Figure 2: Instruments checkout area sketch

HIFI-IEGSE	3 Workstations
PACS-IEGSE	3 Workstations
SPIRE-IEGSE	3 Workstations

IEGSE Firewall            1 PC  
1 Fax machine (tbc)

All IEGSE Workstations are interconnected via a special VLAN (IEGSE-VLAN).  
This VLAN is available also at Herschel S/C C/O and the LSS test floor.

The Firewall PC creates the bridge to the institutes via a 2nd network interface to the internet.

### **LSS test floor**

On the LSS test floor will be :

- SAS SCOE (3 racks) + desktop controller
- Battery SCOE (1 rack) + desktop controller
- TTC SCOE (1 rack) + desktop controller
- ACMS SCOE (1 rack) + desktop controller
- STR UCE (1 rack)
- TMTD DFE (1 rack)
- Cryo SCOE (1 rack) + desktop controller
- NDIU-lite (1 rack)
- 2 x CCS workstations (1 x PLM, 1 x SVM)
- 1 x CCS-Lite workstation (xmgrace PLM)
- 3 STAMP PCs (1 x PLM, 1 x SVM, 1 x Alarms)
- 4 Dynaworks workstations (1 x SVM, 1 x PLM, 1x facility data, 1 x ESA observer)
- 1 Fax machine (tbc)

The rest of the S/C check-out equipment remains in the check-out area.

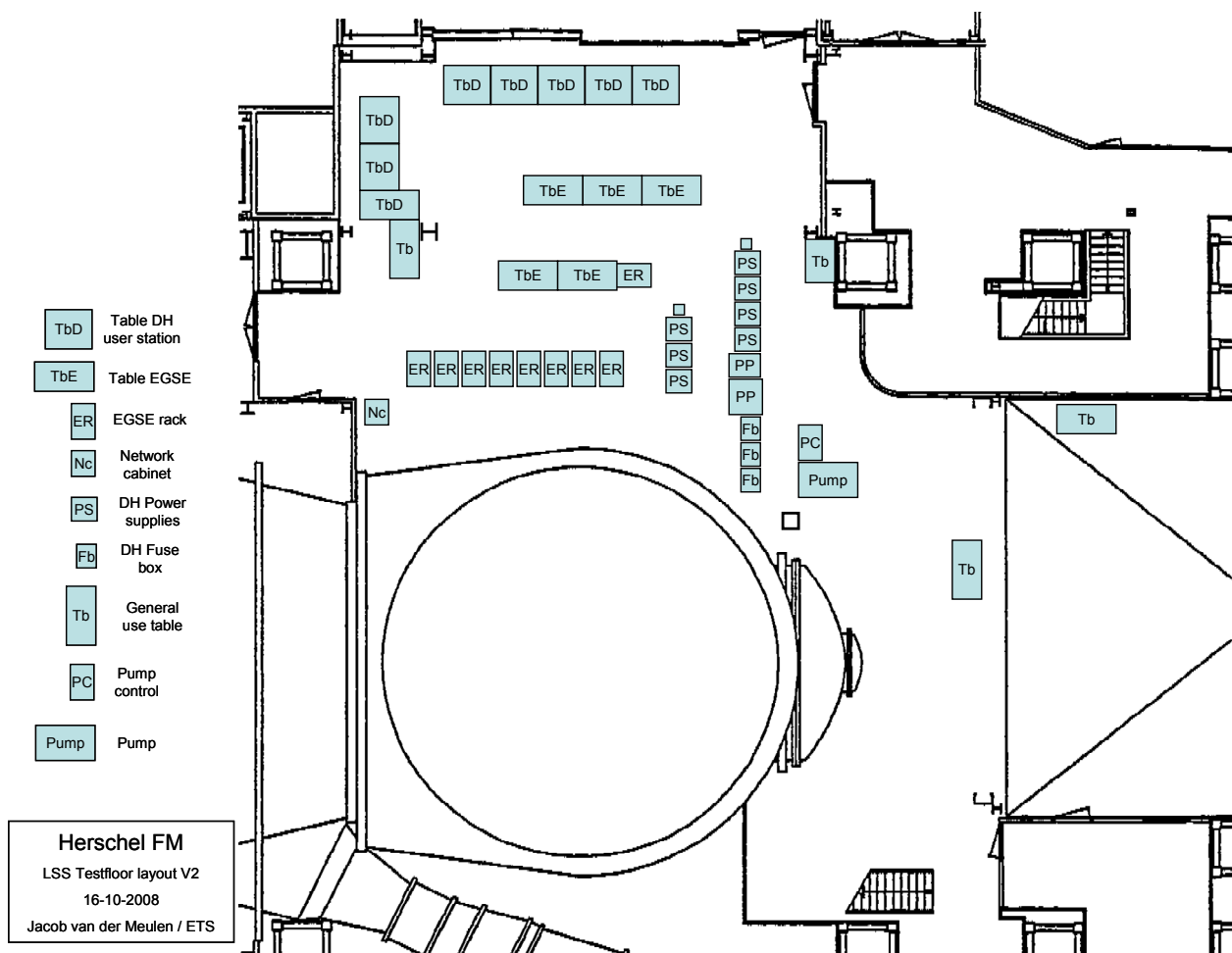

Figure 3: LSS test floor sketch

**S/C checkout**

The rest of the S/C checkout equipment remains in the S/C checkout area.

## 5 Test Criteria

### 5.1 Stability Criteria

Steady-state is reached when the equilibrium temperature sensors (TDH temperature sensors, SCOE Pt1000 and C100 sensors) fulfil the following criteria:

$$\Delta Val = |Val_{average, tp} - Val_{average, tp - \Delta t}| < Threshold$$

$Val_{average, tp}$  Value averaged over 1 hour, averaging begins 1 hr before present time  $tp$

$Val_{average, tp - \Delta t}$  Value averaged over 1 hour, averaging begins at  $\Delta t + 1$  hr and ends at  $\Delta t$  before present time  $tp$

With

Value	$\Delta t$	Threshold
SVM temperature	8 hrs	1 K
Temperature of CVV	24 hrs	0.3 K

The equilibrium criterion illustrated in the following figure shall be checked continuously via the LSS TDH and the Cryo SCOE, respectively.

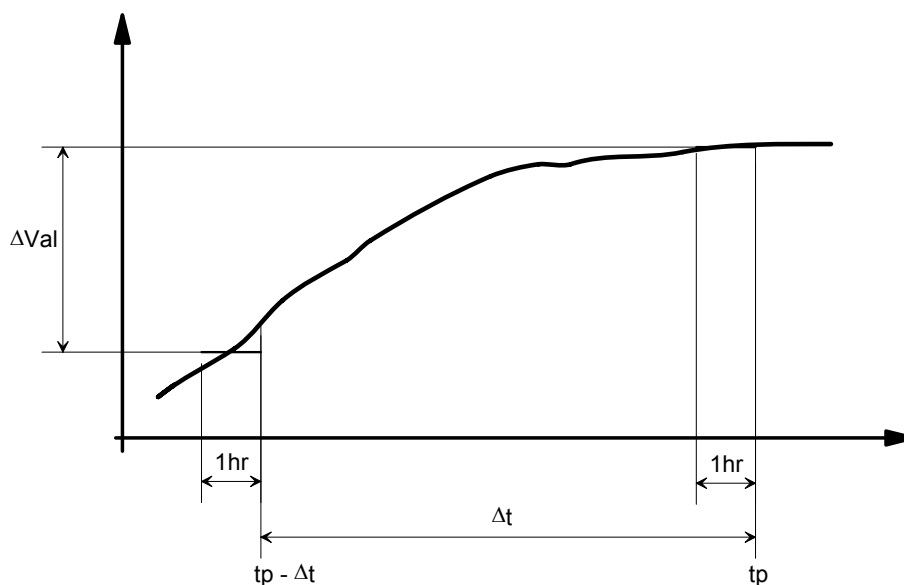



## 6 Summary Sheets

### 6.1 Non Conformance Report (NCR) Summary

NCR - No.	NCR - Title	Date	Open / Closed	PA sig.

**6.2 Sign-off Sheet**

	<b>Date</b>	<b>Signature</b>
<b>Test Director</b>		
<b>Test Conductor</b>		
<b>PA Responsible</b>		
<b>ESA Representative</b>		

## Annex A Sensor Warning and Alarm Limits

The warning and alarm limits for all flight sensors are managed by the CCS. No special test limits have been defined, the flight values are applicable.

No warning and alarm limits shall be implemented for the test sensors which are not mentioned in the tables below

### A.1 TDH Sensor Warning and Alarm Limits

The complete list of predefined alarm limits is available to ETS and on test floor.

PLM and test equipment alarm limits are shown in the table below. Refer to [AD25] for a list of the different SVM alarm limits sets.

Number	Name	Low alarm [K]	Low warning [K]	High warning [K]	High alarm [K]	Extrapolation range [hh:mm:ss]	Low slope [K/min]	High slope [K/min]	Alarm on UNDEFINED	Entropy threshold
4001	PLM_SVTS_TC_SVM-TS-Face-pY	125	130	313	318					
4002	PLM_SVTS_TC_SVM-TS-Face-mY	125	130	313	318					
4010	PLM_SVTS_TC_SVM-TS-Strut-pY-lower	125	130	313	318					
4011	PLM_SVTS_TC_SVM-TS-Strut-pY-upper	125	130	313	318					
4012	PLM_SVTS_TC_SVM-TS-Strut-pY-face	125	130	313	318					
4020	PLM_SVTS_TC_SVM-TS-Strut-mZ-lower	125	130	313	318					
4021	PLM_SVTS_TC_SVM-TS-Strut-mZ-upper	125	130	313	318					
4022	PLM_SVTS_TC_SVM-TS-Strut-mZ-face	125	130	313	318					
9000	EQU_HACS_TC_mZ-radiator	243	248	313	318					

Number	Name	Low alarm [K]	Low warning [K]	High warning [K]	High alarm [K]	Extrapolation range [hh:mm:ss]	Low slope [K/min]	High slope [K/min]	Alarm on UNDEFINED	Entropy threshold
9001	EQU_HACS_TC_mZ-electronics	243	248	323	333	00:10:00				
9010	EQU_HACS_TC_pZ-radiator	243	248	313	318					
9011	EQU_HACS_TC_pZ-electronics	243	248	323	333	00:10:00				
8002	EQU_RIG_TC_HSS-Rig-lower-py-l2	250	270	377	382					
8102	EQU_RIG_TC_HSS-Rig-lower-mid-l2	250	270	377	382					
8212	EQU_RIG_TC_HSS-Rig-lower-my-r2	250	270	377	382					
8004	EQU_RIG_TC_HSS-Rig-lower-py-l4	250	270	377	382					
8104	EQU_RIG_TC_HSS-Rig-lower-mid-l4	250	270	377	382					
8214	EQU_RIG_TC_HSS-Rig-lower-my-r4	250	270	377	382					
8302	EQU_RIG_TC_HSS-Rig-upper-py-l2	185	190	323	328					
8402	EQU_RIG_TC_HSS-Rig-upper-mid-l2	185	190	323	328					
8512	EQU_RIG_TC_HSS-Rig-upper-my-r2	185	190	323	328					
8304	EQU_RIG_TC_HSS-Rig-upper-py-l4	185	190	323	328					
8404	EQU_RIG_TC_HSS-Rig-upper-mid-l4	185	190	323	328					
8514	EQU_RIG_TC_HSS-Rig-upper-my-r4	185	190	323	328					
8305	EQU_RIG_TC_HSS-Rig-upper-py-l5	185	190	323	328					
8406	EQU_RIG_TC_HSS-Rig-upper-mid-l6	185	190	323	328					
8515	EQU_RIG_TC_HSS-Rig-upper-my-r5	185	190	323	328					
8318	EQU_RIG_TC_HSS-Rig-upper-py-r8	185	190	323	328					
8408	EQU_RIG_TC_HSS-Rig-upper-mid-l8	185	190	323	328					
8508	EQU_RIG_TC_HSS-Rig-upper-my-l8	185	190	323	328					
8701	EQU_Rig_TC_Support-pY	280	288	336	340					
8702	EQU_Rig_TC_Support-pZ1	280	288	336	340					
8703	EQU_Rig_TC_Support-pZ2	280	288	336	340					
8704	EQU_Rig_TC_Support-mY	280	288	336	340					

Number	Name	Low alarm [K]	Low warning [K]	High warning [K]	High alarm [K]	Extrapolation range [hh:mm:ss]	Low slope [K/min]	High slope [K/min]	Alarm on UNDEFINED	Entropy threshold
39800	C_EQU_THA_TC_9800- Sk06-J05 connector	-55	-50	100	105					
39810	C_EQU_THA_TC_9810-signal harness close to SK06	-55	-50	100	105					
39801	C_EQU_THA_TC_9801-SK02-J0 connector	-55	-50	100	105					
39811	C_EQU_THA_TC_9811-signal harness close to SK02	-55	-50	100	105					
39821	C_EQU_THA_TC_9821-signal cable nom	-55	-50	100	105					
39831	C_EQU_THA_TC_9831-signal cable red	-55	-50	100	105					
39806	C_EQU_THA_TC_9806-TGC waveguide	-55	-50	100	105					
39816	C_EQU_THA_TC_9816-Coax cable	-55	-50	100	105					
39826	C_EQU_THA_TC_9826-coax cable nom S/C side	-55	-50	100	105					
39846	C_EQU_THA_TC_9846-coax cable nom lss side	-55	-50	100	105					
39836	C_EQU_THA_TC_9836-coax cable red SC side	-55	-50	100	105					
39856	C_EQU_THA_TC_9856-coax cable red lss side	-55	-50	100	105					
39804	C_EQU_THA_TC_9804-umb cable nom	-55	-50	100	105					
39814	C_EQU_THA_TC_9814-umb cable red	-55	-50	100	105					
39802	C_EQU_THA_TC_9802- umbilical bracket -Z	-55	-50	100	105					
39812	C_EQU_THA_TC_9812-umbilical cable close to -Z bracket	-55	-50	100	105					
39803	C_EQU_THA_TC_9803- Sk01A-J02 connector	-55	-50	100	105					
39813	C_EQU_THA_TC_9813- power harness close to SK01A	-55	-50	100	105					
39823	C_EQU_THA_TC_9823-pwr cable nom	-55	-50	100	105					
39833	C_EQU_THA_TC_9833-pwr cable red	-55	-50	100	105					
39807	C_EQU_THA_TC_PLM-Test-harness-upper-pY	-180	-175	105	110					
39808	C_EQU_THA_TC_PLM-Test-harness-upper-pZ	-180	-175	105	110					
39817	C_EQU_THA_TC_PLM-Test-harness-lower-pY	-180	-175	105	110					
39818	C_EQU_THA_TC_PLM-Test-harness-lower-pZ	-180	-175	105	110					



Number	Name	Low alarm [K]	Low warning [K]	High warning [K]	High alarm [K]	Extrapolation range [hh:mm:ss]	Low slope [K/min]	High slope [K/min]	Alarm on UNDEFINED	Entropy threshold
2310	LOU_RAD_TC_rad-heater-control	90	95	145	150					
2320	LOU_SUP_TC_mZ	90	95	145	150					
2321	LOU_SUP_TC_pZ	90	95	145	150					

## **Annex B Wiring Lists for TDH Sensors**

The wiring lists in the following section include the TDH instrumentation with exception of the HSS-TCR thermocouples and heaters, for which the wiring lists are defined by ETS.

The wiring list for the TDH test heaters is given in Section 5.2, Table 5.2.1.

### **B.1 Pt100 Sensors**

The complete Pt100 sensor harness is thermally anchored to the Spin Box Shroud.

Refer to [RD3] for detailed lists.



## B.2 Thermocouples

Refer to [RD3] and [RD4] for detailed lists.



## Annex C Verification of Test Heaters

There is a two-step method to verify the test heater lines at test site (check-outs shall also be performed during integration):

Resistance measurement at the test heater power supply interface rack on the test floor. This rack interfaces the test heater lines coming from the LSS and the test heater power supply and monitoring part of the TDH system. Using an Ohm-meter, the total resistance (i.e. heater plus cable) of each test heater line can be measured, but only if the relevant power supply is disconnected. The measured values shall be filled into the “circuit R on connector” column of table 5.2-1.

As soon as a test heater power connector has been plugged in at the spin box plug dome all affected heater circuits shall be powered up to approx. 20% of the maximum allowed current for each circuit (see table 5.2-1). The total resistance measured by the power supply shall be filled into the “circuit R on PS” column of table 5.2-1. It shall be verified that the derived total resistance (heaters and cable) is greater than the resistance expected only for the heaters:

$$R_{\text{total}} = \frac{U_{\text{measured}}}{I_{\text{measured}}} = R_{\text{cable}} + R_{\text{Heaters}} > R_{\text{Heaters}}$$

If not, the expected heater resistance obviously is wrong and shall be verified.

In order to verify the proper operation of every heater, all test heater lines shall be successively powered up to the specified current during 30 minutes (duration can be shortened or lengthened, depending on the thermal response). During these tests, the power consumption and current in each line shall be measured, and the temperatures of all relevant thermocouples shall be recorded. The temperature at each heater location or unit will be monitored by means of a reference temperature sensor.

**After completion of this verification it shall be checked once again  
that all heater circuits are switched off!**

Maximum allowed current values as listed in Table 5.2-1 are the maximum currents  $I_{\text{max}}$  allowed by the heater itself or the LSS power pins of the respective heater line. They supersede the current range of the selected power supply and shall be used as current limits of the respective test heater lines.



Heater circuit name	Circuit No.	Connector for power	Pins for power	Heater circuit resistance	Circuit R on connector	Circuit R on PS	Max P allowed [W]	Max I allowed [A]	Max U allowed [V]	ESTEC PS number	PS Type	Control sensor / virtual	Check ok
CVV_05_LB-mY	5	5A-4	13,14	10.57			80	2.751	33.21	249	SSP240	1300	
CVV_06_LC-pZ	6	5A-4	1, 2	10.98			140	3.571	44.56	250	SSP240	1005	
CVV_07_UC-pZ	7	5A-4	3, 4	10.40			90	2.942	35.01	251	SSP240	1004	
CVV_08_UB-mZ	8	5A-4	11,12	7.93			110	3.724	35.12	252	SSP240	1101	
CVV_09_Rad-lower-mY	9	5A-3	11, 12	12.48			100	2.831	39.57	253	SSP240	2011	
CVV_10_Rad-upper-mY	10	5A-3	1, 2	9.98			130	3.609	41.43	254	SSP240	1107	
CVV_11_Rad-lower-mZ	11	5A-3	3, 4	12.48			100	2.831	39.57	255	SSP240	2113	
CVV_12_Rad-upper-mZ	12	15A-1	5, 6	7.13			180	5.025	40.85	256	SSP240	1104	
CVV_13_Rad-lower-pY	13	5A-3	5, 6	12.48			100	2.831	39.57	257	SSP240	2214	
CVV_14_Rad-upper-pY	14	5A-3	7, 8	9.98			130	3.609	41.43	258	SSP240	1103	
CVV_15_UB-HSIF-mZ	15	5A-3	9, 10	7.93			110	3.724	35.12	259	SSP240	1102	
LOU_16_rad-lower	16	5A-4	7, 8	11.65			90	2.779	36.55	260	SSP240	2310	
LOU_17_rad-upper	17	5A-4	9, 10	11.65			90	2.779	36.55	261	SSP240	2310	
CVV_23_LC_pZ	23	5A-3	13, 14	12.50			100	2.828	39.60	262	SSP240	1302	
CVV_24_LC_pZ	24	5A-3	15, 16	12.50			100	2.828	39.60	263	SSP240	1005	

Heater circuit name	Circuit No.	Connector for power	Pins for power	Heater circuit resistance	Circuit R on connector	Circuit R on PS	Max P allowed [W]	Max I allowed [A]	Max U allowed [V]	ESTEC PS number	PS Type	Control sensor / virtual	Check ok
CVV_25_UC_pZ	25	5A-4	5,6	12.48			100	2.831	39.57	264	SSP240	1000	
CVV_35_LB-pY	35	5A-4	15, 16	10.57			80	2.751	33.21	265	SSP240	1301	
IRRIG_63_support	63	15A-3	5,6	14.80	15.1		100	2.599	41.07	266	SSP240	8702	
IRRIG_64_support_red	64	15A-3	7,8	14.80	15.1		100	2.599	41.07	328	SSP240	8702	
SVM_ACC_Py_L1	70	5A-1	1, 2	208.00	214		30	0.380	79.56	267	SSP240		
SVM_Battery_Py_L2	71	5A-1	3, 4	200.00	197		31	0.394	79.33	268	SSP240		
SVM_CDMU_pY_L3	72	5A-1	5, 6	100.00	110		64	0.800	81.20	269	SSP240		
SVM_PCDU_pY_L4	73	5A-1	7, 8	33.33	34		192	2.400	83.60	270	SSP240		
SVM_SPIRE_mZ_L5	74	5A-1	9, 10	104.00	108		61	0.766	80.80	271	SSP240		
SVM_HIFI-2_mYmZ_L6	75	5A-5	1, 2	69.33	72		92	1.152	81.59	272	SSP240		
SVM_DECMEC_pYmZ_L7	76	5A-2	1, 2	138.70	141		46	0.576	80.74	273	SSP240		
SVM_BOLC_pYmZ_L8	77	5A-2	3, 4	118.90	122		53	0.668	80.38	274	SSP240		
SVM_RWS_mYpZ_L9	78	5A-5	3, 4	28.57	30		224	2.800	84.20	275	SSP240		
SVM_HIFI-1_mYpZ_L11	79	5A-5	7, 8	46.80	48		136	1.705	82.34	276	SSP240		
SVM_HIFI-1_mYmZ_2_L10	80	5A-5	5, 6	31.30	32		205	2.559	83.94	277	SSP240		



ITP for Herschel FM TB/TV

Herschel

Heater circuit name	Circuit No.	Connector for power	Pins for power	Heater circuit resistance	Circuit R on connector	Circuit R on PS	Max P allowed [W]	Max I allowed [A]	Max U allowed [V]	ESTEC PS number	PS Type	Control sensor / virtual	Check ok
SVM_red_ACC_Py_L1	90	5A-1	11, 12	208.00	215		30	0.380	79.56	278	SSP240		
SVM_red_Battery_Py_L2	91	5A-1	13, 14	200.00	198		31	0.394	79.33	279	SSP240		
SVM_red_CDMU_pY_L3	92	5A-1	15, 16	100.00	100		64	0.800	81.20	280	SSP240		
SVM_red_PCDU_pY_L4	93	5A-1	17, 18	33.33	34		192	2.400	83.60	281	SSP240		
SVM_red_SPIRE_mZ_L5	94	5A-1	19, 20	104.00			61	0.766	80.80	282	SSP240		
SVM_red_HIFI-2_mYmZ_L6	95	5A-5	09, 10	69.33			92	1.152	81.59	283	SSP240		
SVM_red_DECMEC_pYmZ_L7	96	5A-2	5, 6	138.70			46	0.576	80.74	284	SSP240		
SVM_red_BOLC_pYmZ_L8	97	5A-2	7, 8	118.90	123		53	0.668	80.38	285	SSP240		
SVM_red_RWS_mYpZ_L9	98	5A-5	11, 12	28.57			224	2.800	84.20	286	SSP240		
SVM_red_HIFI-1_mYmZ_L10	99	5A-5	13, 14	31.20			136	2.088	68.27	287	SSP240		
SVM_red_HIFI-1_mYpZ_2_L11	100	5A-5	15, 16	46.80			204	2.088	100.84	288	SSP240		
panel +Y+Z -TTC lamp 1	101	5A-2	9, 10	31.25			200	4.000	56.00	289	SSP240		
panel +Y+Z -TTC lamp 1 offset	101	5A-2	9, 10	31.25			200	4.000	56.00	290	SSP240	(Setpoint other PS)	
panel +Y+Z -TTC lamp 2	102	5A-2	11, 12	31.25			200	4.000	56.00	291	SSP240		



Heater circuit name	Circuit No.	Connector for power	Pins for power	Heater circuit resistance	Circuit R on connector	Circuit R on PS	Max P allowed [W]	Max I allowed [A]	Max U allowed [V]	ESTEC PS number	PS Type	Control sensor / virtual	Check ok
panel +Y+Z -TTC lamp 2 offset	102	5A-2	11, 12	31.25			200	4.000	56.00	292	SSP240	(Setpoint other PS)	
panel +Y+Z -TTC lamp 3	103	5A-2	13, 14	31.25			200	4.000	56.00	293	SSP240		
panel +Y+Z -TTC lamp 3 offset	103	5A-2	13, 14	31.25			200	4.000	56.00	294	SSP240	(Setpoint other PS)	
panel +Y+Z -TTC lamp 4	104	5A-2	15, 16	31.25			200	4.000	56.00	295	SSP240		
panel +Y+Z -TTC lamp 4 offset	104	5A-2	15, 16	31.25			200	4.000	56.00	296	SSP240	(Setpoint other PS)	
TTAS enclosure -STR lamp 1	105	15A-2	5,6	31.25			200	4.000	54.00	297	SSP240		
TTAS enclosure -STR lamp 1 offset	105	15A-2	5,6	31.25			200	4.000	54.00	298	SSP240	(Setpoint other PS)	
TTAS enclosure -STR lamp 2	106	15A-2	7,8	31.25			200	4.000	54.00	299	SSP240		
TTAS enclosure -STR lamp 2 offset	106	15A-2	7,8	31.25			200	4.000	54.00	300	SSP240	(Setpoint other PS)	
Harness coax nom	107	5A-2	17, 18	59.90			100	1.292	79.33	301	SSP240	39826	
Harness coax red	108	5A-2	19, 20	48.60			120	1.571	78.72	302	SSP240	39836	



Heater circuit name	Circuit No.	Connector for power	Pins for power	Heater circuit resistance	Circuit R on connector	Circuit R on PS	Max P allowed [W]	Max I allowed [A]	Max U allowed [V]	ESTEC PS number	PS Type	Control sensor / virtual	Check ok
deleted	109	1A-1	5, 6	0.00			0	#DIV/0!	#DIV/0!	303	SSP240		
deleted	110	1A-1	7, 8	0.00			0	#DIV/0!	#DIV/0!	304	SSP240		
Harness signal nom	111	1A-1	9, 10	104.90			38	0.602	64.64	305	SSP240	39821	
Harness signal red	112	1A-1	11, 12	104.50			38	0.603	64.52	306	SSP240	39831	
TTAS	113	15A-2	9, 10	14.00			240	4.140	62.11	307	SSP240	9101	
TTAS_red	114	15A-2	11, 12	14.00			240	4.140	62.11	329	SSP240	9102	
Harness umb nom	115	1A-1	1, 2	126.60			48	0.616	79.49	308	SSP240	39804	
Harness umb red	116	1A-1	3, 4	120.80			50	0.643	79.33	330	SSP240	39814	
Harness power nom	117	1A-1	5, 6	85.70			70	0.904	79.71	309	SSP240	39823	
Harness power red	118	1A-1	7, 8	85.80			70	0.903	79.76	331	SSP240	39833	
IRRIG_23_1st_row_pY	123	B5/2 1A-7 IR-RIG-1	1, 2	40.00			100	1.581	63.25	310	SSP240	8002	
IRRIG_24_1st_row_mid	124	B5/2 1A-7 IR-RIG-1	5, 6	40.00			100	1.581	63.25	311	SSP240	8102	
IRRIG_25_1st_row_mY	125	B5/2 1A-7 IR-RIG-1	9, 10	40.00			100	1.581	63.25	312	SSP240	8212	
IRRIG_26_2nd_row_pY	126	B5/2 1A-7 IR-RIG-1	13, 14	40.00			100	1.581	63.25	313	SSP240	8004	

Heater circuit name	Circuit No.	Connector for power	Pins for power	Heater circuit resistance	Circuit R on connector	Circuit R on PS	Max P allowed [W]	Max I allowed [A]	Max U allowed [V]	ESTEC PS number	PS Type	Control sensor / virtual	Check ok
IRRIG_27_2nd_row_mid	127	B5/2 1A-7 IR-RIG-1	17, 18	40.00			100	1.581	63.25	314	SSP240	8104	
IRRIG_28_2nd_row_mY	128	B5/2 1A-7 IR-RIG-1	21, 22	40.00			100	1.581	63.25	315	SSP240	8214	
IRRIG_29_3rd_row_pY	129	B5/2 1A-7 IR-RIG-1	25, 26	40.00			100	1.581	63.25	316	SSP240	8302	
IRRIG_30_3rd_row_mid	130	B5/2 1A-7 IR-RIG-1	29, 30	40.00			100	1.581	63.25	317	SSP240	8402	
IRRIG_31_3rd_row_mY	131	B5/2 1A-7 IR-RIG-1	33, 34	40.00			100	1.581	63.25	318	SSP240	8512	
IRRIG_32_4th_row_pY	132	B5/2 1A-8 IR-RIG-2	1, 2	40.00			100	1.581	63.25	319	SSP240	8304	
IRRIG_33_4th_row_mid	133	B5/2 1A-8 IR-RIG-2	5, 6	40.00			100	1.581	63.25	320	SSP240	8404	
IRRIG_34_4th_row_mY	134	B5/2 1A-8 IR-RIG-2	9, 10	40.00			100	1.581	63.25	321	SSP240	8514	
IRRIG_37_5th_row_pY	137	B5/2 1A-8 IR-RIG-2	13, 14	53.33			77	1.202	64.08	322	SSP240	8305	
IRRIG_38_5th_row_mid	138	B5/2 1A-8 IR-RIG-2	17, 18	40.00			100	1.581	63.25	323	SSP240	8406	
IRRIG_39_5th_row_mY	139	B5/2 1A-8 IR-RIG-2	21, 22	53.33			77	1.202	64.08	324	SSP240	8515	
IRRIG_40_6th_row_pY	140	B5/2 1A-8 IR-RIG-2	25, 26	36.09			26.6	0.859	30.98	325	SSP240	8318	
IRRIG_41_6th_row_mid	141	B5/2 1A-8 IR-RIG-2	29, 30	53.33			77	1.202	64.08	326	SSP240	8408	



Heater circuit name	Circuit No.	Connector for power	Pins for power	Heater circuit resistance	Circuit R on connector	Circuit R on PS	Max P allowed [W]	Max I allowed [A]	Max U allowed [V]	ESTEC PS number	PS Type	Control sensor / virtual	Check ok
IRRIG_42_6th_row_mY	142	B5/2 1A-8 IR-RIG-2	33, 34	36.09			26.6	0.859	30.98	327	SSP240	8508	
IRRIG_43_1st_row_pY_red	143	B5/2 1A-7 IR-RIG-1	3, 4	40.00			100	1.581	63.25	332		8002	
IRRIG_44_1st_row_mid_red	144	B5/2 1A-7 IR-RIG-1	7, 8	40.00			100	1.581	63.25	333		8102	
IRRIG_45_1st_row_mY_red	145	B5/2 1A-7 IR-RIG-1	11, 12	40.00			100	1.581	63.25	334		8212	
IRRIG_46_2nd_row_pY_red	146	B5/2 1A-7 IR-RIG-1	15, 16	40.00			100	1.581	63.25	335		8004	
IRRIG_47_2nd_row_mid_red	147	B5/2 1A-7 IR-RIG-1	19, 20	40.00			100	1.581	63.25	336		8104	
IRRIG_48_2nd_row_mY_red	148	B5/2 1A-7 IR-RIG-1	23, 24	40.00			100	1.581	63.25	337		8214	
IRRIG_49_3rd_row_pY_red	149	B5/2 1A-7 IR-RIG-1	27, 28	40.00			100	1.581	63.25	338		8302	
IRRIG_50_3rd_row_mid_red	150	B5/2 1A-7 IR-RIG-1	31, 32	40.00			100	1.581	63.25	339		8402	
IRRIG_51_3rd_row_mY_red	151	B5/2 1A-7 IR-RIG-1	35, 36	40.00			100	1.581	63.25	340		8512	
IRRIG_52_4th_row_pY_red	152	B5/2 1A-8 IR-RIG-2	3, 4	40.00			100	1.581	63.25	341		8304	
IRRIG_53_4th_row_mid_red	153	B5/2 1A-8 IR-RIG-2	7, 8	40.00			100	1.581	63.25	342		8404	
IRRIG_54_4th_row_mY_red	154	B5/2 1A-8 IR-RIG-2	11, 12	40.00			100	1.581	63.25	343		8514	



Heater circuit name	Circuit No.	Connector for power	Pins for power	Heater circuit resistance	Circuit R on connector	Circuit R on PS	Max P allowed [W]	Max I allowed [A]	Max U allowed [V]	ESTEC PS number	PS Type	Control sensor / virtual	Check ok
IRRIG_57_5th_row_pY_red	157	B5/2 1A-8 IR-RIG-2	15, 16	53.33			77	1.202	64.08	344		8305	
IRRIG_58_5th_row_mid_red	158	B5/2 1A-8 IR-RIG-2	19, 20	40.00			100	1.581	63.25	345		8405	
IRRIG_59_5th_row_mY_red	159	B5/2 1A-8 IR-RIG-2	23, 24	53.33			77	1.202	64.08	346		8515	
IRRIG_60_6th_row_pY_red	160	B5/2 1A-8 IR-RIG-2	27, 28	36.09			26.6	0.859	30.98	347		8318	
IRRIG_61_6th_row_mid_red	161	B5/2 1A-8 IR-RIG-2	31, 32	53.33			77	1.202	64.08	348		8408	
IRRIG_62_6th_row_mY_red	162	B5/2 1A-8 IR-RIG-2	35, 36	36.09			26.6	0.859	30.98	349		8508	

Table 5.2-1: Verification of Test Heater Lines

## Annex D End-of-Phase Reporting

The print-outs, plots and reports listed in the following section will be provided as inputs to the TRB at the end of each test phase.

### D.1 TDH Data

1. Printout of all temperature and power setting data at end of phase
2. Plots of relevant temperatures and power settings for complete phase
  - TC / Pt list as appropriate
  - PS list as appropriate

### D.2 CCS Data

1. Printout of all temperature and power setting data at end of phase
2. Printout of all valve states, pressure, mass flow and level probe values (if available) at end of phase
3. Plots of relevant sensor readings and power settings for complete phase
  - TC / Pt list as appropriate
  - Mass flow, pressures, consumed mass
  - PS list as appropriate
4. Evaluation of HTT filling level

### D.3 CVSE status

Pumps status

Gas meter reading

Safety unit status

CVSE valves status

#### **D.4 Operations / Deviations / NCRs**

ORS list

Procedure variations list

NCR list

## Annex E HACS Integration and Operation Procedure

### E.1 HACS Mechanical Integration

- For transport and storage the cameras are mounted onto a dummy LOU support which is mounted on an aluminium baseplate. The complete assembly is covered by a Perspex cover. To avoid any potential problems with static electricity, mounting or dismounting of the perspex cover shall be performed under electrostatic safe conditions only.
- Installation of the camera head onto the LOU support structure is a very delicate operation that shall be done with extreme care. The spacing between the LOU PPB (Pentaprism Block) and the optics module housing is only 5mm so that extreme care shall be taken not to damage the LOU PPB.
- Place the camera head on the LOU baseplate and insert the M5 bolts (4x). Two persons are needed.
- Insert the dowel pins (2x) using the installation tool and tighten the screws.

### E.2 HACS electrical Integration

#### E.2.1 Light Source Installation

- Ensure that the power rail pigtail is not connected to 220V
- Connect the 10 meter fiber pigtails to the VFT's. Thread the outer barrel only lightly finger tight! Over tightening the barrel will not improve signal transmission and could cause permanent damage. To remove, unthread the barrel and gently pull straight out.
- Connect the two vacuum and cryogenic compatible 18 meter fiber cables to the +/- z cameras. Connect the other ends to the VFT's. Please note that there are two vacuum fibres, one for the +z and one for the -z camera (clearly marked as such), which are not interchangeable. Further, it shall be noted which side on the fibre shall be coupled to the VFT connector and which side shall be coupled to the camera. Identification of the 4 ends of the vacuum fibres is as follows:

	+z	-z
Camera end	+z HAC	-z HAC
VFT end	+z VFT	-z VFT

- Connect the two RS-232 pigtails to the control PC as shown in the next figure.

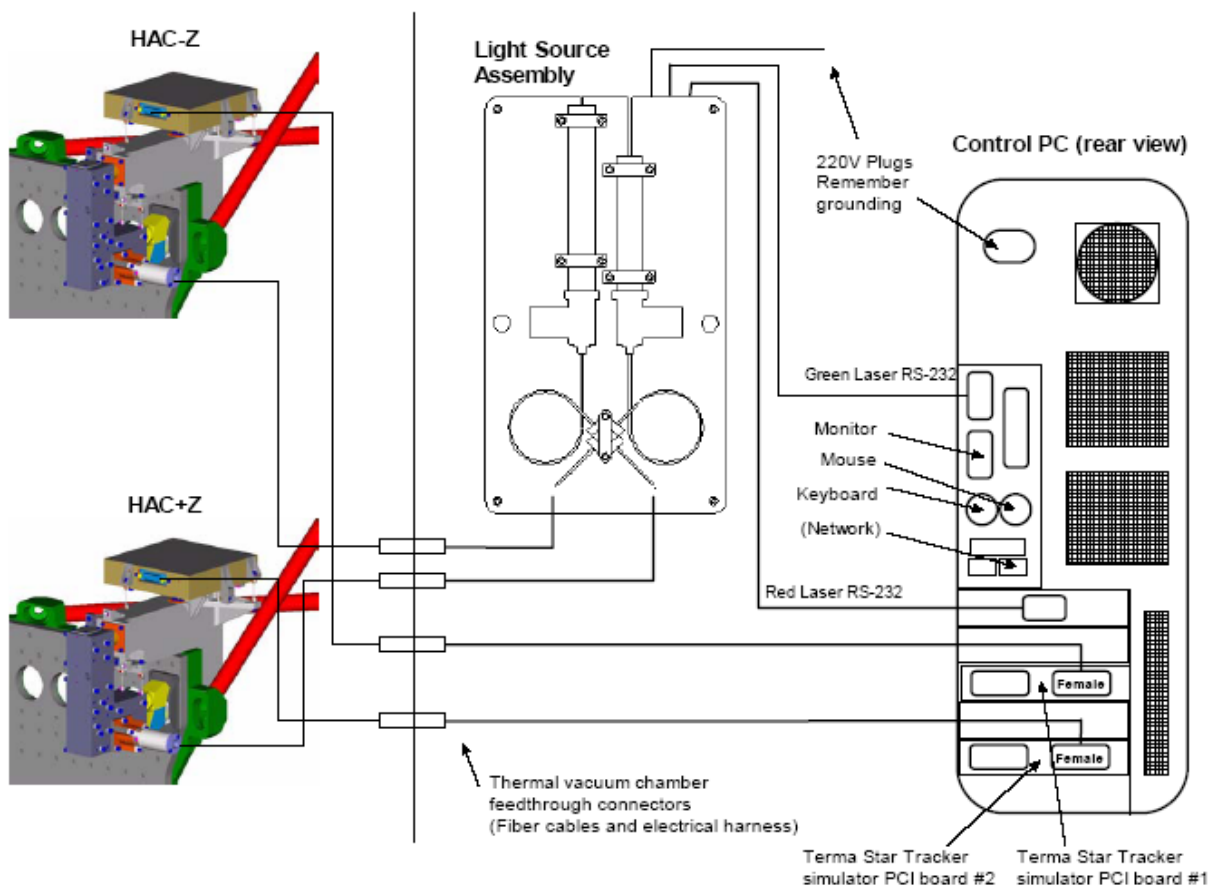

Figure 4: HACS installation

### E.2.2 Control H/W Installation

- Connect a power cable to the PC and the supplied 220V power rail (part of the light source assembly). See Figure 1.2-1
- Connect a power cable to the PC monitor and the supplied 220V power rail (part of the light source assembly).
- Connect the PC monitor, mouse and keyboard.
- Connect the ambient electrical harness to the two PCI boards as shown in Figure 1.2-1. Connect the other end to the applicable pre-mounted VFT's.
- Connect the vacuum and cryogenic compatible electrical harness to the +/-z camera's. Connect the other ends to the VFT's.
  - o To avoid the electrical harness from acting as a heat sink during cold testing, it shall be wrapped in MLI starting at the camera connector over a length of at least 6 meter.
  - o Mechanical supporting of the electrical harness shall be implemented such that negligible strain on the connector of the electronics module results for all temperature conditions.

- Connect the power rail pigtail (from the light source assembly) to 220V.

**E.2.3 Activation**

- Power on the lasers (On /off buttons are located on the light source assembly).
- Power on the HACS control PC and activate the HACS control S/W by double- clicking on the HACS controle software icon on the PC desktop.
- Power on the cameras. This can be done automatically by running the command schedule that is loaded at start-up. Select “Command”-“Execute Schedule” and press “Start”.
- Open the CHU Housekeeping window by selecting “View”-“CHU Housekeeping”. Verify that camera voltages and power consumptions are going to nominal values as shown in Figure 1.2-2.

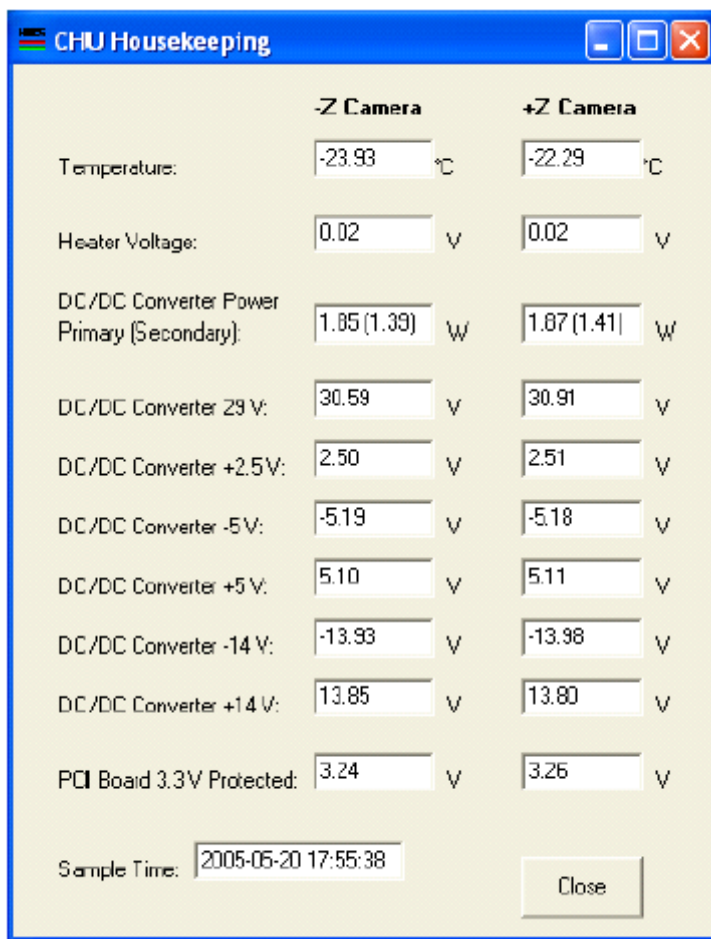

Figure 5: Housekeeping Parameters

A healthy camera has voltages within  $\pm 5\%$  of the nominal values and a primary DC/DC converter power consumption at approximately 1.7W.

### **E.2.4 Adjust Laser and Image Settings**

Laser adjustment shall be made for all four laser / camera combinations. An example is given here for the green laser and the –z Camera.

- Activate the green laser by selecting “Command”-“Light Source Attenuation”. Use the default laser attenuation (1950 steps), select “Green Laser” and press “Execute”.
- Take an image by selecting “Command”-“Image Window Dump”. Select “Dump from –z Camera” and use default values for integration time and image dimensions. Press “Execute”.
- Inspect the image visually by selecting “View”-“Image”. The image should show one reference spot close to the centre of the CCD and one image measurement spot.
- Inspect the spots by double-clicking on them and thus activating the Matrix Viewer. The pixel values in the spots should not be saturated (see User Manual section 7.2.2). If more than two pixels in a spot are saturated (DN of 16383), try and reduce the laser power, for example to 1930 steps and take a new image.
- Check that the software can identify the spots correctly. This is done by selecting “Command”-“Raw Spot Detection” and press “Execute”. The Raw Spot Detection-Latest Results window will become visible. The window shows the CCD coordinates for the identified reference and measurement spot together with spot intensity and size.
  - If Raw Spot detection fails with the message “Too many Sub-Spots”, increase the used Threshold Delta Value as described in the User manual section 7.3.3 and do the Raw Spot Detection again.
  - If only one spot is identified, measurement spot is most likely out of range. This can be further investigated by reducing the Threshold Delta Value and do the Raw Spot Detection again.

## **E.3 Perform Measurements**

Having identified the image integration time and laser attenuation parameters, the actual measurements can be performed. For a full set of translation and rotation measurements four images are required, a green laser image taken with the –z camera, a green laser image taken with the +z camera, a red laser image taken with the –z camera and a red laser image taken with the +z camera.

### **E.3.1 Manually**

For each measurement the following is performed:

- Adjust laser settings as described in chapter 1.2.4
- Perform an “Image Window Dump” for each camera as described in chapter 1.2.4.
- Perform “Raw Spot Detection” for each camera and laser as described in chapter 1.2.4.
- The HACS control software will temporarily save the raw spot detection results from the four images. To get the actual measurements select “Command”-“Rotation / Translation Calculation”
- The Rotation / Translation command window is opened
- The results are displayed in the Measurement view (Figure) and in the Graph view (Figure 1.3-2).

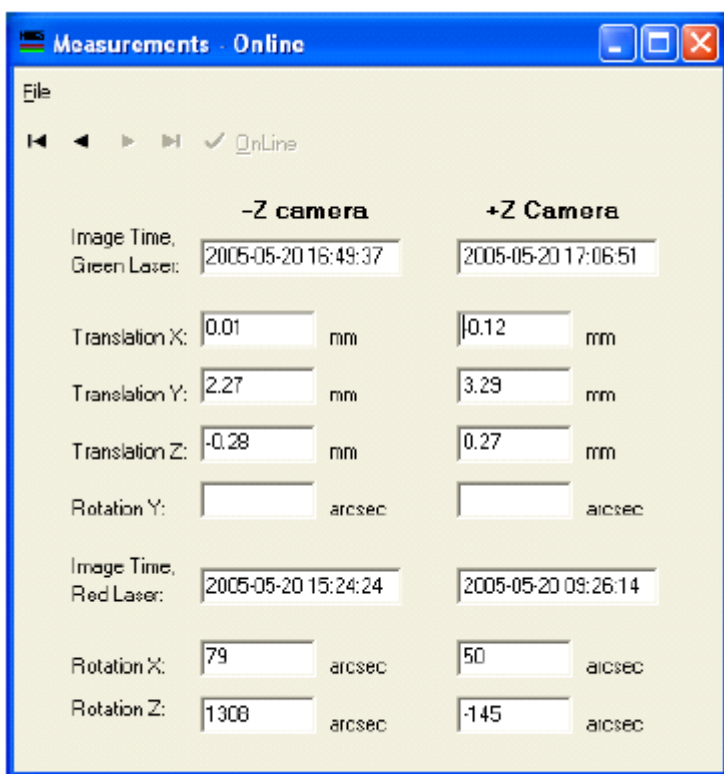

Figure 6: Measurement View



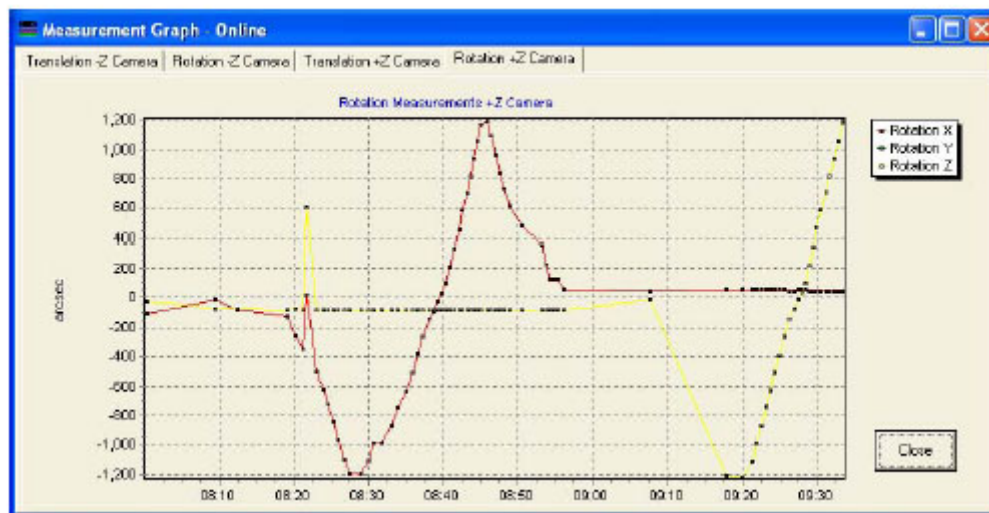

Figure 7: Graph View

### E.3.2 Automatically

The HACS control software includes a command scheduler that makes it possible to execute HACS commands automatically. The schedule can contain up to 1000 commands to be executed within 300 hours. It is possible to re-start the schedule execution automatically with a user defined period between schedule execution times.

Automatically measurements can be performed by using the scheduler as follows:

- Open the Edit Schedule window by selecting "Edit"- "Schedule"
- Load the measurement schedule file "measurement.dat" by selecting "File"- "Load Schedule"
- Close the Edit Schedule window by pressing "Close"
- Start the schedule by selecting "Command"- "ExecuteSchedule". Click the "Cyclic Execution" check box if measurements shall be performed at regular intervals. Start the measurement by pressing "Start".

## E.4 Deactivation

Power off the cameras and move both lasers to the home position as follows:

- Click on the CHU Power On/Off button. The CHU Power On/Off window is opened.
- Deactivate both cameras
- Click on the Light Source attenuation button. The light Source attenuation window is opened.
- An attenuation value of 0 steps moves both lasers to the home position.
- Verify in the Housekeeping window that camera voltages and power consumptions go to zero.

## E.5 Operational Constraints

The HACS camera applicable temperature range is outlined below.

Hot Operational	Cold Operational	Cold Start-up	Cold Non-Operational	Hot Non-Operational
+60°C	-35°C	-35°C	-40°C	+70°C

Compliance to the temperature limits is mandatory in order not to damage the camera electronics. At ambient temperature and vacuum conditions the cameras can be operated at a 50% duty cycle (50% of the time on, 50% off) increasing to 100% at an ambient temperature of -40°C. The built-in temperature control will switch-off the cameras in case they become too warm.

**In the unlikely event that the control PC breaks down during testing, then the following steps must be performed:**

1. Power off the PC and light source assembly
2. Disconnect the camera electrical harness from the two PC PCI boards
3. Connect the supplied heater plug 26-pin connector to the camera electrical harness pigtails
4. Connect the heater plug red (+) and Black (-) banana plugs to a +10V DC power supply. The DC power supply must be capable of supplying in total  $2 \times 2.5 = 5W$
5. Switch on the +10V DC power supply
6. Monitor the camera temperatures via the additional thermo-couplers under LSS responsibility and insure that the temperatures do not drop below -35°C

## Annex F Form Sheets

The following form sheets will be used during the test:

**ORS:** An Operation Request Sheet will be issued whenever specific actions are to be taken as planned in the ITP (e.g. test phase transition, valve status change...) in order to guarantee traceability.

**PVS:** Procedure Variation Sheets will be issued when a deviation from the planned test sequence as defined in the ITP has to be performed.

The Test Conductor Data Sheet gives an overview of the overall test timeline.



<b>Procedure Variation Sheet</b>		Curr. No.:
		Date:
		Page:            of
Test designation Herschel FM TB/TV	Test Procedure HP-2-ASED-TP-0177	Issue 1
Test step changed	Reason for Change	
Prepared by:	Test Conductor	Project Engineer
PA/QA	Test Director	Customer

<b>TEST CONDUCTOR DATA SHEET</b>			
<b>Herschel FM TB/TV Test</b>			
Test Phase	Expected Duration (hrs)	Actual	
		Date & Time of TP start (UTC)	Duration (hrs)
TP-A - Functional tests and S/C preparation	520		
TP-B - LEOP and SVM Cold	148		
TP-C - PLM Rapid Cool-Down and SVM heat-up	56		
TP-D – TV Phase HIFI 0-1	11		
TP-E – Combined Instruments TV	8		
TP-F – HIFI TV Test 2	28		
TP-G – SPIRE TV and SVM TB Hot	48		
TP-H – HIFI TV Test 3	53		
TP-I – PACS TV Test	32		
TP-J – HIFI TV Test 4	78		
TP-K – SVM TV HOT	64		
SOVT2 at end of TP-K	120		
TP-L - Recovery to Ambient	72		
Test end	-		-
<b>Total Test Time</b>	1238		
<b>Total Test Time (from start of LEOP)</b>	718		

Annex G Helium flow chart and CVSE instrumentation

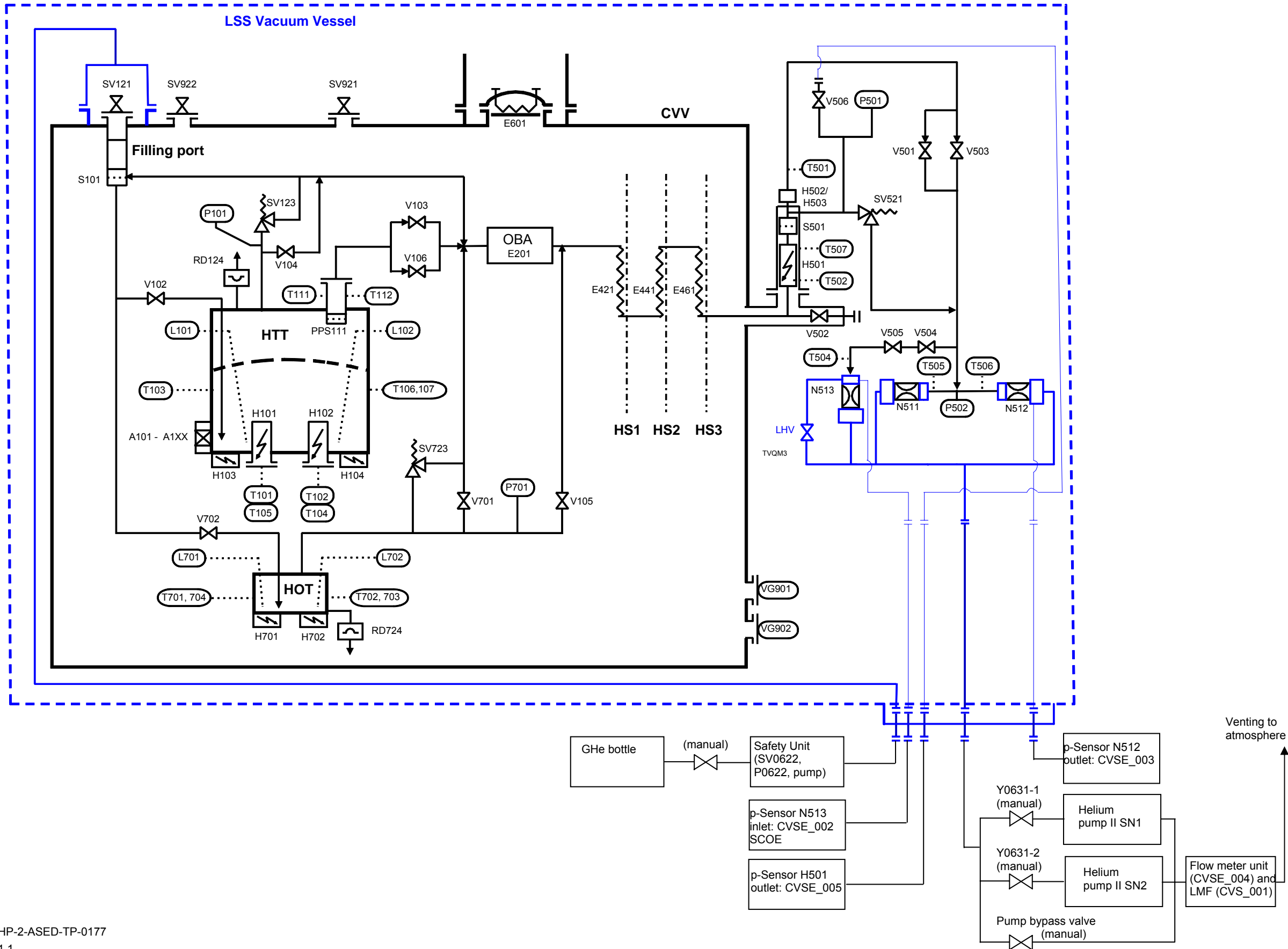

**Annex H Data tables**

**H.1.1 Tilting Angles for PPS Operation**

HTT filling level / %	Nominal tilt angle
97.9	3.5
97.6	4
97	5
95.3	7.5
93.4	10
91.3	12.5
89.1	15
86.9	17.5
84.6	20
82.2	22.5
79.75	25
77.2	27.5

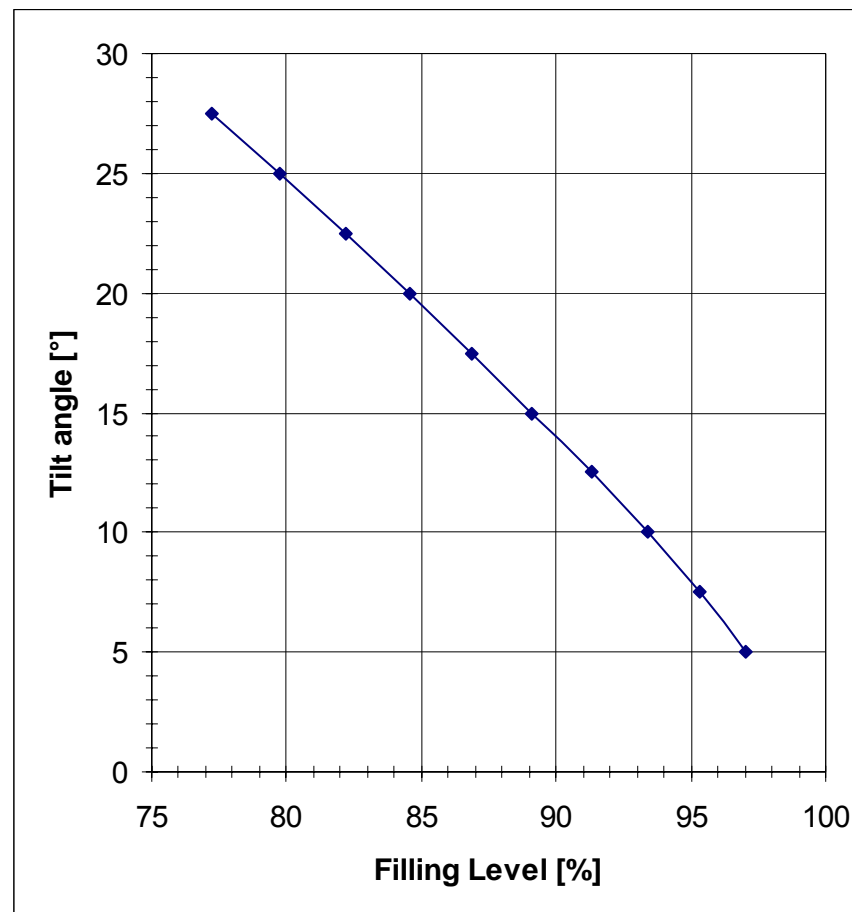

The tilting angles given in the table above represent the calculated values for immersion of the porous plug in the bulk liquid. To guarantee safe operation of the PPS, the tilt angle shall be adjusted to 1° above the immersion values on a daily basis (maximum He consumption via PPS per day is 0.5% fill level, i.e. less than 1°).



**H.1.2 SVM TCS heater lines cycling control table**

Fill in the following table to trace cycling of SVM TCS heater lines:

Note : BEWARE OF THE CONFUSION TCS LINE NUMBER / LOOP INDEX

TCS line number (ref. H-PAI-TN-0069)	Loop Index	Location	Heater's location Herschel	THM 1	THM 2	THM 3	measured reference	Control Loop Class	Nominal Heater HPS(HCS)	Redundant Heater HPS(HCS)	TCS line number (ref. H-PAI-TN-0069)	Test phase	Cycling date / time	Remarks
Spare	1		Decontamination Heating 1	N/A	N/A	N/A	ThermAvgTemp001	N/A	1(1)	18(1)	Spare			
Spare	7		Decontamination Heating 3	N/A	N/A	N/A	ThermAvgTemp007	A	2(1)	17(1)	Spare			
Spare	12		Propellant tanks	THM-52	THM-100	N/A	ThermAvgTemp012	A	2(6)	17(6)	Spare			
Spare	19		Decontamination Heating 5	N/A	N/A	N/A	ThermAvgTemp019	A	4(1)	15(1)	Spare			
Spare	31		Decontamination Heating 7	N/A	N/A	N/A	ThermAvgTemp031	A	6(1)	13(1)	Spare			
Spare	49		Decontamination Heating 8	N/A	N/A	N/A	ThermAvgTemp049	A	9(1)	10(1)	Spare			
TcsLine01	6	+Y+Z	XPND1	THM-49	THM-97	THM-145	ThermAvgTemp006	A	1(6)	18(6)	TcsLine01			
TcsLine02	2	+Y+Z	XPND2	THM-50	THM-98	THM-146	ThermAvgTemp002	A	1(2)	18(2)	TcsLine02			
TcsLine03	38	+Y	BATTERY (*)	THM-51	THM-99	THM-147	ThermAvgTemp038	A	7(2)	12(2)	TcsLine03			
TcsLine05	11	+Y-Z	FPSPU / FPDPU	THM-53	THM-101	THM-149	ThermAvgTemp011	A	2(5)	17(5)	TcsLine05			
TcsLine06	13	+Y-Z	FPBOLC	THM-54	THM-102	THM-150	ThermAvgTemp013	A	3(1)	16(1)	TcsLine06			
TcsLine07	14	+Y+Z	CRS1	THM-55	THM-103	THM-151	ThermAvgTemp014	A	3(2)	16(2)	TcsLine07			
TcsLine08	15	+Y-Z	FPDECMC	THM-56	THM-104	THM-152	ThermAvgTemp015	A	3(3)	16(3)	TcsLine08			
TcsLine09	16	RCS	PIPES	THM-57	THM-105	THM-153	ThermAvgTemp016	A	3(4)	16(4)	TcsLine09			
TcsLine10	17	-Z	CCU/HSDCU/HSFCU	THM-58	THM-106	THM-154	ThermAvgTemp017	A	3(5)	16(5)	TcsLine10			
TcsLine11	5	RCS	PIPES	THM-59	THM-107	THM-155	ThermAvgTemp005	A	1(5)	18(5)	TcsLine11			
TcsLine12	20	-Y-Z	FHWOV	THM-60	THM-108	THM-156	ThermAvgTemp020	B	4(2)	15(2)	TcsLine12			
TcsLine13	43	-Y-Z	FHHRV	THM-61	THM-109	THM-157	ThermAvgTemp043	A	8(1)	11(1)	TcsLine13			
TcsLine14	53	STR 1 Pr. Baf.	STR 1 Primary Baffle	THM-62	THM-110	THM-158	ThermAvgTemp053	A	9(5)	10(5)	TcsLine14			
TcsLine15	27	-Y-Z	FHWEV/FHICU	THM-63	THM-111	THM-159	ThermAvgTemp027	A	5(3)	14(3)	TcsLine15			
TcsLine16	39	-Y	FHWOH	THM-64	THM-112	THM-160	ThermAvgTemp039	B	7(3)	12(3)	TcsLine16			
TcsLine17	40	-Y	FHWEH	THM-65	THM-113	THM-161	ThermAvgTemp040	A	7(4)	12(4)	TcsLine17			
TcsLine18	26	-Y	FHHRH	THM-66	THM-114	THM-162	ThermAvgTemp026	A	5(2)	14(2)	TcsLine18			
TcsLine19	48	-Y	FHLCU/FHIFH	THM-67	THM-115	THM-163	ThermAvgTemp048	A	8(6)	11(6)	TcsLine19			
TcsLine20	52	-Y	FHLSU	THM-68	THM-116	THM-164	ThermAvgTemp052	A	9(4)	10(4)	TcsLine20			
TcsLine21	36	-Y+Z	RWL2	THM-69	THM-117	THM-165	ThermAvgTemp036	A	6(6)	13(6)	TcsLine21			
TcsLine22	32	-Y+Z	RWL4	THM-70	THM-118	THM-166	ThermAvgTemp032	A	6(2)	13(2)	TcsLine22			
TcsLine23	33	-Y+Z	RWL1	THM-71	THM-119	THM-167	ThermAvgTemp033	A	6(3)	13(3)	TcsLine23			
TcsLine24	34	-Y+Z	RWL3	THM-72	THM-120	THM-168	ThermAvgTemp034	A	6(4)	13(4)	TcsLine24			
TcsLine25	54	TANKS	TANK+Y	THM-73	THM-121	THM-169	ThermAvgTemp054	A	9(6)	10(6)	TcsLine25			
TcsLine26	50	TANKS	TANK-Y	THM-74	THM-122	THM-170	ThermAvgTemp050	A	9(2)	10(2)	TcsLine26			
TcsLine27	37	STAR	STAR TRACKER	THM-75	THM-123	THM-171	ThermAvgTemp037	B	7(1)	12(1)	TcsLine27			

TCS line number (ref. H-PAI-TN-0069)	Loop Index	Location	Heater's location Herschel	THM 1	THM 2	THM 3	measured reference	Control Loop Class	Nominal Heater HPS(HCS)	Redundant Heater HPS(HCS)	TCS line number (ref. H-PAI-TN-0069)	Test phase	Cycling date / time	Remarks
		<b>TRAC.</b>												
TcsLine28	35	<b>-Y-Z</b>	FHIFV	THM-76	THM-124	THM-172	ThermAvgTemp035	A	6(5)	13(5)	TcsLine28			
TcsLine29	22	<b>20 N TH</b>	FCV A1A	THM-77	THM-125	THM-173	ThermAvgTemp022	A	4(4)	15(4)	TcsLine29			
TcsLine30	23	<b>20 N TH</b>	FCV C2A	THM-78	THM-126	THM-174	ThermAvgTemp023	A	4(5)	15(5)	TcsLine30			
TcsLine31	41	<b>20 N TH</b>	FCV C1A	THM-79	THM-127	THM-175	ThermAvgTemp041	A	7(5)	12(5)	TcsLine31			
TcsLine32	42	<b>20 N TH</b>	FCV A2A	THM-80	THM-128	THM-176	ThermAvgTemp042	A	7(6)	12(6)	TcsLine32			
TcsLine33	51	<b>20 N TH</b>	FCV C4A	THM-81	THM-129	THM-177	ThermAvgTemp051	A	9(3)	10(3)	TcsLine33			
TcsLine34	44	<b>20 N TH</b>	FCV C3A	THM-82	THM-130	THM-178	ThermAvgTemp044	A	8(2)	11(2)	TcsLine34			
TcsLine35	45	<b>RCS</b>	PIPES	THM-83	THM-131	THM-179	ThermAvgTemp045	A	8(3)	11(3)	TcsLine35			
TcsLine36	46	<b>STR 2 Pr. Baf.</b>	STR 2 Primary Baffle	THM-84	THM-132	THM-180	ThermAvgTemp046	A	8(4)	11(4)	TcsLine36			
TcsLine37	47	<b>RCS</b>	PIPES	THM-85	THM-133	THM-181	ThermAvgTemp047	A	8(5)	11(5)	TcsLine37			
TcsLine38	18	<b>Gyro</b>	GYRO	THM-86	THM-134	THM-182	ThermAvgTemp018	A	3(6)	16(6)	TcsLine38			
TcsLine39	3	<b>20 N TH</b>	FCV A1B	THM-87	THM-135	THM-183	ThermAvgTemp003	A	1(3)	18(3)	TcsLine39			
TcsLine40	4	<b>20 N TH</b>	FCV C2B	THM-88	THM-136	THM-184	ThermAvgTemp004	A	1(4)	18(4)	TcsLine40			
TcsLine41	8	<b>20 N TH</b>	FCV C1B	THM-89	THM-137	THM-185	ThermAvgTemp008	A	2(2)	17(2)	TcsLine41			
TcsLine42	9	<b>20 N TH</b>	FCV A2B	THM-90	THM-138	THM-186	ThermAvgTemp009	A	2(3)	17(3)	TcsLine42			
TcsLine43	10	<b>20 N TH</b>	FCV C4B	THM-91	THM-139	THM-187	ThermAvgTemp010	A	2(4)	17(4)	TcsLine43			
TcsLine44	28	<b>20 N TH</b>	FCV C3B	THM-92	THM-140	THM-188	ThermAvgTemp028	A	5(4)	14(4)	TcsLine44			
TcsLine45	21	<b>RCS</b>	PIPES	THM-93	THM-141	THM-189	ThermAvgTemp021	A	4(3)	15(3)	TcsLine45			
TcsLine46	24	<b>RCS</b>	PIPES	THM-94	THM-142	THM-190	ThermAvgTemp024	A	4(6)	15(6)	TcsLine46			
TcsLine47	29	<b>RCS</b>	PIPES	THM-95	THM-143	THM-191	ThermAvgTemp029	A	5(5)	14(5)	TcsLine47			
TcsLine48	30	<b>RCS</b>	PT/LV1/LV2/LF	THM-96	THM-144	THM-192	ThermAvgTemp030	A	5(6)	14(6)	TcsLine48			
TcsLine49	25	<b>+Y+Z</b>	CRS2	THM-12	THM-20	THM-36	ThermAvgTemp025	A	5(1)	14(1)	TcsLine49			

**H.1.3 Test heater settings**

SVM test heaters – Refer to [AD25] for test heater settings

Heater circuit name	Circuit No.	Heater circuit resistance	Max P [W]	Max P allowed [W]	Max I [A]	Max I allowed [A]	ESTEC PS number	PS Type	Control sensor / virtual	Control type
SVM_ACC_Py_L1	70	208.00	30	30	0.380	0.380	267	SSP240		Manual
SVM_Battery_Py_L2	71	200.00	31	31	0.394	0.394	268	SSP240		Manual
SVM_CDMU_pY_L3	72	100.00	64	64	0.800	0.800	269	SSP240		Manual
SVM_PCDU_pY_L4	73	33.33	192	192	2.400	2.400	270	SSP240		Manual
SVM_SPIRE_mZ_L5	74	104.00	61	61	0.766	0.766	271	SSP240		Manual
SVM_HIFI-2_mYmZ_L6	75	69.33	92	92	1.152	1.152	272	SSP240		Manual
SVM_DECMEC_pYmZ_L7	76	138.70	46	46	0.576	0.576	273	SSP240		Manual
SVM_BOLC_pYmZ_L8	77	118.90	53	53	0.668	0.668	274	SSP240		Manual
SVM_RWS_mYpZ_L9	78	28.57	224	224	2.800	2.800	275	SSP240		Manual
SVM_HIFI-1_mYpZ_L11	79	46.80	136	136	1.705	1.705	276	SSP240		Manual
SVM_HIFI-1_mYmZ_2_L10	80	31.30	205	205	2.559	2.559	277	SSP240		Manual
SVM_red_ACC_Py_L1	90	208.00	30	30	0.380	0.380	278	SSP240		Manual
SVM_red_Battery_Py_L2	91	200.00	31	31	0.394	0.394	279	SSP240		Manual
SVM_red_CDMU_pY_L3	92	100.00	64	64	0.800	0.800	280	SSP240		Manual
SVM_red_PCDU_pY_L4	93	33.33	192	192	2.400	2.400	281	SSP240		Manual
SVM_red_SPIRE_mZ_L5	94	104.00	61	61	0.766	0.766	282	SSP240		Manual
SVM_red_HIFI-2_mYmZ_L6	95	69.33	92	92	1.152	1.152	283	SSP240		Manual
SVM_red_DECMEC_pYmZ_L7	96	138.70	46	46	0.576	0.576	284	SSP240		Manual
SVM_red_BOLC_pYmZ_L8	97	118.90	53	53	0.668	0.668	285	SSP240		Manual
SVM_red_RWS_mYpZ_L9	98	28.57	224	224	2.800	2.800	286	SSP240		Manual
SVM_red_HIFI-1_mYmZ_L10	99	18.70	136	136	2.697	2.697	287	SSP240		Manual
SVM_red_HIFI-1_mYpZ_2_L11	100	31.30	204	204	2.553	2.553	288	SSP240		Manual
panel +Y+Z -TTC lamp 1	101	31.25	200	200	4.000	4.000	289	SSP240		Fixed voltage
panel +Y+Z -TTC lamp 1 offset	101	31.25	200	200	4.000	4.000	290	SSP240	(Setpoint other PS)	Formula voltage
panel +Y+Z -TTC lamp 2	102	31.25	200	200	4.000	4.000	291	SSP240		Fixed voltage
panel +Y+Z -TTC lamp 2 offset	102	31.25	200	200	4.000	4.000	292	SSP240	(Setpoint other PS)	Formula voltage
panel +Y+Z -TTC lamp 3	103	31.25	200	200	4.000	4.000	293	SSP240		Fixed voltage
panel +Y+Z -TTC lamp 3 offset	103	31.25	200	200	4.000	4.000	294	SSP240	(Setpoint other PS)	Formula voltage
panel +Y+Z -TTC lamp 4	104	31.25	200	200	4.000	4.000	295	SSP240		Fixed voltage

Heater circuit name	Circuit No.	Heater circuit resistance	Max P [W]	Max P allowed [W]	Max I [A]	Max I allowed [A]	ESTEC PS number	PS Type	Control sensor / virtual	Control type
panel +Y+Z -TTC lamp 4 offset	104	31.25	200	200	4.000	4.000	296	SSP240	(Setpoint other PS)	Formula voltage
TTAS enclosure -STR lamp 1	105	31.25	200	200	4.000	4.000	297	SSP240		Fixed voltage
TTAS enclosure -STR lamp 1 offset	105	31.25	200	200	4.000	4.000	298	SSP240	(Setpoint other PS)	Formula voltage
TTAS enclosure -STR lamp 2	106	31.25	200	200	4.000	4.000	299	SSP240		Fixed voltage
TTAS enclosure -STR lamp 2 offset	106	31.25	200	200	4.000	4.000	300	SSP240	(Setpoint other PS)	Formula voltage

PLM warm-up heaters

Heater circuit name	Circuit No.	Heater circuit resistance	Max P [W]	Max P allowed [W]	Max I [A]	Max I allowed [A]	ESTEC PS number	PS Type	Control sensor / virtual	Control type	Mode A
CVV_05_LB-mY	5	10.57	80	80	2.751	2.751	249	SSP240	1300	Thermostatic current	293 K
CVV_06_LC-pZ	6	10.98	140	140	3.571	3.571	250	SSP240	1005	Thermostatic current	293 K
CVV_07_UC-pZ	7	10.40	90	90	2.942	2.942	251	SSP240	1004	Thermostatic current	293 K
CVV_08_UB-mZ	8	7.93	110	110	3.724	3.724	252	SSP240	1101	Thermostatic current	293 K
CVV_09_Rad-lower-mY	9	12.48	100	100	2.831	2.831	253	SSP240	2011	Thermostatic current	293 K
CVV_10_Rad-upper-mY	10	9.98	130	130	3.609	3.609	254	SSP240	1107	Thermostatic current	293 K
CVV_11_Rad-lower-mZ	11	12.48	100	100	2.831	2.831	255	SSP240	2113	Thermostatic current	293 K
CVV_12_Rad-upper-mZ	12	7.13	180	180	5.025	5.025	256	SSP240	1104	Thermostatic current	293 K
CVV_13_Rad-lower-pY	13	12.48	100	100	2.831	2.831	257	SSP240	2214	Thermostatic current	293 K
CVV_14_Rad-upper-pY	14	9.98	130	130	3.609	3.609	258	SSP240	1103	Thermostatic current	293 K
CVV_15_UB-HSIF-mZ	15	7.93	110	110	3.724	3.724	259	SSP240	1102	Thermostatic current	293 K
LOU_16_rad-lower	16	11.65	90	90	2.779	2.779	260	SSP240	2310	Thermostatic current	293 K
LOU_17_rad-upper	17	11.65	90	90	2.779	2.779	261	SSP240	2310	Thermostatic current	293 K
CVV_23_LC_pZ	23	12.50	100	100	2.828	2.828	262	SSP240	1302	Thermostatic current	293 K
CVV_24_LC_pZ	24	12.50	100	100	2.828	2.828	263	SSP240	1005	Thermostatic current	293 K
CVV_25_UC_pZ	25	12.48	100	100	2.831	2.831	264	SSP240	1000	Thermostatic current	293 K
CVV_35_LB-pY	35	10.57	80	80	2.751	2.751	265	SSP240	1301	Thermostatic current	293 K

Infrared Rig heaters

Heater circuit name	Circuit No.	Heater circuit resistance	Max P [W]	Max P allowed [W]	Max I [A]	Max I allowed [A]	ESTEC PS number	PS Type	Control sensor / virtual	Control type	Mode A	Mode B
IRRIG_63_support	63	14.80	100	100	2.599	2.599	266	SSP240	8702	Thermostatic current	293 K	333 K
IRRIG_64_support_red	64	14.80	100	100	2.599	2.599	328	SSP240	8702	Thermostatic current	293 K	333 K
IRRIG_23_1st_row_pY	123	40.00	100	100	1.581	1.581	310	SSP240	8002	Thermostatic current	<b>293 K</b>	<b>373 K</b>
IRRIG_24_1st_row_mid	124	40.00	100	100	1.581	1.581	311	SSP240	8102	Thermostatic current	293 K	373 K
IRRIG_25_1st_row_mY	125	40.00	100	100	1.581	1.581	312	SSP240	8212	Thermostatic current	293 K	373 K
IRRIG_26_2nd_row_pY	126	40.00	100	100	1.581	1.581	313	SSP240	8004	Thermostatic current	293 K	373 K
IRRIG_27_2nd_row_mid	127	40.00	100	100	1.581	1.581	314	SSP240	8104	Thermostatic current	293 K	373 K
IRRIG_28_2nd_row_mY	128	40.00	100	100	1.581	1.581	315	SSP240	8214	Thermostatic current	293 K	373 K
IRRIG_29_3rd_row_pY	129	40.00	100	100	1.581	1.581	316	SSP240	8302	Thermostatic current	<b>193 K</b>	<b>293 K</b>
IRRIG_30_3rd_row_mid	130	40.00	100	100	1.581	1.581	317	SSP240	8402	Thermostatic current	193 K	293 K
IRRIG_31_3rd_row_mY	131	40.00	100	100	1.581	1.581	318	SSP240	8512	Thermostatic current	193 K	293 K
IRRIG_32_4th_row_pY	132	40.00	100	100	1.581	1.581	319	SSP240	8304	Thermostatic current	193 K	293 K
IRRIG_33_4th_row_mid	133	40.00	100	100	1.581	1.581	320	SSP240	8404	Thermostatic current	193 K	293 K
IRRIG_34_4th_row_mY	134	40.00	100	100	1.581	1.581	321	SSP240	8514	Thermostatic current	193 K	293 K
IRRIG_37_5th_row_pY	137	53.33	77	77	1.202	1.202	322	SSP240	8305	Thermostatic current	193 K	293 K
IRRIG_38_5th_row_mid	138	40.00	100	100	1.581	1.581	323	SSP240	8406	Thermostatic current	193 K	293 K
IRRIG_39_5th_row_mY	139	53.33	77	77	1.202	1.202	324	SSP240	8515	Thermostatic current	193 K	293 K
IRRIG_40_6th_row_pY	140	36.09	26.6	26.6	0.859	0.859	325	SSP240	8318	Thermostatic current	193 K	293 K
IRRIG_41_6th_row_mid	141	53.33	77	77	1.202	1.202	326	SSP240	8408	Thermostatic current	193 K	293 K
IRRIG_42_6th_row_mY	142	36.09	26.6	26.6	0.859	0.859	327	SSP240	8508	Thermostatic current	193 K	293 K
IRRIG_43_1st_row_pY_red	143	40.00	100	100	1.581	1.581	332		8002	Thermostatic current	<b>293 K<sup>1)</sup></b>	<b>373 K<sup>1)</sup></b>
IRRIG_44_1st_row_mid_red	144	40.00	100	100	1.581	1.581	333		8102	Thermostatic current	293 K <sup>1)</sup>	373 K <sup>1)</sup>
IRRIG_45_1st_row_mY_red	145	40.00	100	100	1.581	1.581	334		8212	Thermostatic current	293 K <sup>1)</sup>	373 K <sup>1)</sup>
IRRIG_46_2nd_row_pY_red	146	40.00	100	100	1.581	1.581	335		8004	Thermostatic current	293 K <sup>1)</sup>	373 K <sup>1)</sup>
IRRIG_47_2nd_row_mid_red	147	40.00	100	100	1.581	1.581	336		8104	Thermostatic current	293 K <sup>1)</sup>	373 K <sup>1)</sup>
IRRIG_48_2nd_row_mY_red	148	40.00	100	100	1.581	1.581	337		8214	Thermostatic current	293 K <sup>1)</sup>	373 K <sup>1)</sup>
IRRIG_49_3rd_row_pY_red	149	40.00	100	100	1.581	1.581	338		8302	Thermostatic current	<b>193 K<sup>1)</sup></b>	<b>293 K<sup>1)</sup></b>
IRRIG_50_3rd_row_mid_red	150	40.00	100	100	1.581	1.581	339		8402	Thermostatic current	193 K <sup>1)</sup>	293 K <sup>1)</sup>
IRRIG_51_3rd_row_mY_red	151	40.00	100	100	1.581	1.581	340		8512	Thermostatic current	193 K <sup>1)</sup>	293 K <sup>1)</sup>
IRRIG_52_4th_row_pY_red	152	40.00	100	100	1.581	1.581	341		8304	Thermostatic current	193 K <sup>1)</sup>	293 K <sup>1)</sup>
IRRIG_53_4th_row_mid_red	153	40.00	100	100	1.581	1.581	342		8404	Thermostatic current	193 K <sup>1)</sup>	293 K <sup>1)</sup>
IRRIG_54_4th_row_mY_red	154	40.00	100	100	1.581	1.581	343		8514	Thermostatic current	193 K <sup>1)</sup>	293 K <sup>1)</sup>
IRRIG_57_5th_row_pY_red	157	53.33	77	77	1.202	1.202	344		8305	Thermostatic current	193 K <sup>1)</sup>	293 K <sup>1)</sup>
IRRIG_58_5th_row_mid_red	158	40.00	100	100	1.581	1.581	345		8405	Thermostatic current	193 K <sup>1)</sup>	293 K <sup>1)</sup>
IRRIG_59_5th_row_mY_red	159	53.33	77	77	1.202	1.202	346		8515	Thermostatic current	193 K <sup>1)</sup>	293 K <sup>1)</sup>
IRRIG_60_6th_row_pY_red	160	36.09	26.6	26.6	0.859	0.859	347		8318	Thermostatic current	193 K <sup>1)</sup>	293 K <sup>1)</sup>
IRRIG_61_6th_row_mid_red	161	53.33	77	77	1.202	1.202	348		8408	Thermostatic current	193 K <sup>1)</sup>	293 K <sup>1)</sup>
IRRIG_62_6th_row_mY_red	162	36.09	26.6	26.6	0.859	0.859	349		8508	Thermostatic current	193 K <sup>1)</sup>	293 K <sup>1)</sup>

1) Redundant IR Rig heaters to be used only in case of failure of nominal heater line.

Test equipment heaters

Heater circuit name	Circuit No.	Heater circuit resistance	Max P [W]	Max P allowed [W]	Max I [A]	Max I allowed [A]	ESTEC PS number	PS Type	Control sensor / virtual	Control type	Mode A
Harness coax nom	107	59.00	100	100	1.302	1.302	301	SSP240	39826	Thermostatic current	20 °C
Harness coax red	108	49.00	120	120	1.565	1.565	302	SSP240	39836	Thermostatic current	20 °C
Harness signal nom	111	110.00	38	38	0.588	0.588	305	SSP240	39821	Thermostatic current	20 °C
Harness signal red	112	110.00	38	38	0.588	0.588	306	SSP240	39831	Thermostatic current	20 °C
TTAS	113	14.00	240	240	4.140	4.140	307	SSP240	9101	Thermostatic current	20 °C
TTAS_red	114	14.00	240	240	4.140	4.140	329	SSP240	9102	Thermostatic current	20 °C
Harness umb nom	115	110.00	55	55	0.707	0.707	308	SSP240	39804	Thermostatic current	20 °C
Harness umb red	116	110.00	55	55	0.707	0.707	330	SSP240	39814	Thermostatic current	20 °C
Harness power nom	117	85.70	70	70	0.904	0.904	309	SSP240	39823	Thermostatic current	20 °C
Harness power red	118	85.80	70	70	0.903	0.903	331	SSP240	39833	Thermostatic current	20 °C

## Annex I Integrated Step-by-Step Procedure

The following chapter contains the Integrated Step-by-Step Test Procedure. Each section describes a complete test phase and is subdivided in a first overview sheet, followed by a table for the test steps in four columns, to be performed by the shift leader / TCS, CCS, ETS TDH and ETS LSS control, respectively. The test steps table for each phase contains three sections, to be performed at the beginning, during and at the end of the phase.

Test steps can be referenced by an unambiguous identifier, e.g. TP-A-1-T10, which is composed of the test phase (TP-A-), the beginning (1-), during (2-) or end (3-) identifier, the TCS (T), CCS (C), TDH (D) or LSS control (L) identifier and the sequential number.

The test phases nomenclature used in the current ITP is not in line with the phase definition in the test spec [AD4]. To guarantee traceability, the respective phase number from the test spec is annotated in the first column of the step by step procedure below, identified as "TS #x" where x represents the [AD4] phase number.

The "maximum predicted Power" values of the test heaters in the tables below are maximum powers during the complete test, not for the individual phase.

I.1 Functional tests and S/C preparation

Phase	TP-A – Functional tests and S/C preparation	Type: stable	S/C Attitude	Tilt /° : 0
Expected Duration / hrs	260	TTAS I/F 20°C	+Z to collimator mirror	
Objective	<ul style="list-style-type: none"> <li>Final setup and check-out of test equipment (CVSE, CCS, TDH, test MLI, videogrammetry, HACS)</li> <li>Check of SVM TCS (ATC)</li> <li>S/C tilting verification (followed by electrical verification of harness test heater lines)</li> <li>Dry-run of TB/TV functional procedure</li> <li>TT&amp;C tests as per [AD31].</li> <li>Cryostat preparation to achieve representative initial conditions for LEOP simulation: HTT He II top-up, pump-down and Thermal Shields cooling from external dewar, followed by a non-cooled phase to increase the TS1 temperature and HTT / HOT heating to target launch condition.</li> <li>Videogrammetry measurement under ambient and vacuum conditions</li> </ul>			
End of Phase Condition	<ul style="list-style-type: none"> <li>Cryostat in launch conditions: <ul style="list-style-type: none"> <li>Fill level 96% -0/+2%</li> <li>HTT temperature &lt; 1.947 K</li> <li>HOT temperature &lt; 35 K</li> <li>OBA temperature &lt; 49.4 K</li> <li>Shield 1 temperature &lt; 100.6 K</li> <li>Shield 2 temperature &lt; 144 K</li> <li>Shield 3 temperature &lt; 208 K (212 K tbc)</li> </ul> </li> <li>SVM in launch mode</li> <li>LSS closed and pumped down, ready for cool-down of shrouds</li> </ul>			
Important Remarks	<p>Mechanical S/C installation in the LSS is covered by [AD17] which is executed before the current ITP.</p> <p>Completion of electrical [AD18], CCS [AD19], CVSE [AD20], HACS [AD21], videogrammetry [AD23] and thermal setup [AD24] are covered by detailed procedures which are called from the current procedure. Final check-out activities will be performed in parallel to the activities defined here below. After installation in the LSS, He II production and top-up will be performed [AD27].</p> <p>The functional dry-run will be based on a red-lined version of the TB/TV functional procedure. The expected duration for the dry run is 5 days. The Dry Run scope extends to:</p> <ul style="list-style-type: none"> <li>SVM: launch mode, TB-COLD, TV-COLD, TB-HOT, TV-HOT.</li> <li>Decontamination: LOU baffle, Telescope.</li> <li>PLM: LEOP, Rapid Cool Down.</li> <li>Instrument tests.</li> </ul> <p>The following operations shall not be rehearsed during the Dry Run, but the demonstration of their feasibility shall be demonstrated before chamber closure:</p> <ul style="list-style-type: none"> <li>PLM valve operations.</li> <li>Nozzle switching.</li> </ul> <p>The LOU N2 purge line shall be removed as late as possible. During / after chamber evacuation, the S/C will be switched off to avoid exceeding maximum acceptance temperatures on the power panel units.</p> <p>Although this phase comprises mainly preparations for the actual TB/TV test, <b>it is important to keep the planned sequence and duration</b> in order to reach the representative launch conditions, especially the HTT, HOT and Thermal Shield 1 temperatures, at the end of the phase.</p>			

Test location:	ETS / LSS	Shift leader:	PA / QA:	Date:
----------------	-----------	---------------	----------	-------



	<p>Based on STM1 experience, the expected duration for LSS operations from beginning of scaffolding removal to readiness for shrouds cool-down is ~51 hrs.</p> <p>Planned sequence after end of He operations: He II top-up CVSE removal while pumping on V502</p> <ol style="list-style-type: none"> <li>1. End of He operations</li> <li>2. Preparation for TB/TV (<b>Facility preops</b>) - <b>8 hours (2 pers)</b> in parallel: Removal of CVSE helium setup (<b>ASED – 8 hrs, 6 pers</b>)</li> <li>2. Removal of He tower by crane - <b>1 hour (3 pers)</b></li> <li>3. Removal of scaffolding, level A&amp;B&amp;C&amp;D by crane ( <b>ETS will make it's possible to remove the maximum items by hands</b>) - <b>9 hours (4 pers)</b></li> <li>4. Removal of basic scaffolding (partly by crane) - <b>8 hours (4 pers)</b></li> <li>5. Installation of MLI patches on supports, <b>bottom and lower cylinder - 3 hours (2 pers)</b></li> <li>6. Installation of VDG scalebar <b>2 hours</b> (according to A. Cozzani)</li> <li>7. Flying Dutch man for MLI on VDG flange - <b>1/2 hour 2 (pers)</b></li> <li>8. Cleaning of main (C1) and auxiliary chamber (C2) + shroud 3 - <b>2 hours (2 pers)</b></li> <li>9. CP1 leak detection - <b>1 hour (2 pers)</b></li> <li>10. Moving of the LSS lid over the chamber + <b>removal of the top lid trolley 1 hour (3 pers)</b>+ removal of telescope foil, Astrium activity <b>-(1 hr, 10 pers)</b></li> <li>11. Closure of the Top lid - <b>1 hour (3 pers)</b></li> <li>12. Closure of the 5 m door + leak check - <b>2 hours (2 pers)</b></li> <li>13. Perform VDG measurement to verify correct operation - 1 hr</li> <li>13. 5 m door barriers removal in the basement for pumping unit installation - <b>1/2 hour (1 pers)</b></li> <li>14. Check motion system tilt operations (<b>both side</b>) - <b>1 hour (2 pers)</b></li> <li>15. Witness plate &amp; QCM installation - <b>1 hour</b></li> <li>16. Closure of the man door &amp; Start pumping down - <b>1 hour</b></li> <li>17. Estimate duration of the pumping down - <b>6 hours</b></li> <li>18. LSS leak check flanges - <b>2 hours</b></li> <li>19. Start cool down</li> </ol> <p>The overall expected duration from end of He operations to readiness for shrouds cool-down is thus 52 hrs.</p> <p>According to TMM predictions, the Thermal Shields cooling has to be stopped not earlier than 55 hrs before the launch simulation, i.e. sufficient margins have to be foreseen for unexpected events in the sequence after the end of shields cooling. The available time span can be extended to ~61 hrs by HTT pumping (mass flow ~10 mg/s) for 1 day at the end of the shields cooling.</p> <p>TP-A covers the test spec phases TS #0 and TS #1, and part of TS #2</p>
--	--

Test location:	ETS / LSS	Shift leader:	PA / QA:	Date:
----------------	-----------	---------------	----------	-------

Step	Phase:	TP-A – Functional tests and S/C preparation		Remarks / NCR	
	Test Floor: TCS, CVSE, Cryo	CCS: Instruments, PLM, SVM	FACILITY DATA HANDLING      LSS CONTROL		
TP-A-1 start of phase	<p>1. <b>Cryo Valve States:</b> (unchanged)</p> <p>V102: closed V104: closed V103: closed V106: closed V701: closed V702: closed V105: closed V501: closed V503: closed V504: open V505: open TV QM3: closed</p> <p>2. Helium venting via V502 / CVSE or via opening V501/V503 on request of Cryo Engineer</p>	<p>1. <b>Main Title:</b> Herschel FM TB/TV Test</p> <p>2. <b>Subtitle:</b> TP-A - Functional tests and S/C preparation</p> <p>3. Start new section in Log Book</p> <p>4. Fill in: Date / Time of start: ..... / .....</p> <p>5. <b>CCS Alarm Limits:</b> keep predefined CCS alarm limits throughout test</p> <p>6. <b>CCS data logging:</b> Start script "K102999ECVT035_ASDGEN_SCOE_CCU_LOG.tcl"; acquisition interval 30 sec.</p> <p>7. <b>SVM state and active PM:</b> CDMS: Launch / A ACMS: S.By / A TT&amp;C / XPND: OFF</p> <p>8. <b>Instrument states:</b> PACS: OFF SPIRE: OFF HIFI: OFF</p>	<p>1. <b>Main Title:</b> Herschel FM TB/TV Test</p> <p>2. <b>Subtitle:</b> TP-A - Functional tests and S/C preparation</p> <p>3. <b>Alarm Limits:</b> alarms off</p> <p>4. <b>Acquisition Interval:</b> 2 min</p> <p>5. <b>TDH Test Heaters:</b> all off</p>	<p>1. <b>Sun Simulator:</b> off</p> <p>2. <b>Shrouds:</b> <u>C1 shroud:</u> ambient <u>C2 shroud:</u> ambient</p> <p>3. <b>Pressure:</b> ambient</p> <p>4. <b>Spin Box:</b> <u>Temperature:</u> ambient <u>Tilt angle:</u> 0°</p> <p>5. <b>5m door and Cover:</b> open</p> <p>LSS status before S/C transfer:</p> <ul style="list-style-type: none"> <li>• MLI curtain installed</li> <li>• MLI patches installed (except on supports, bottom and lower cylinder parts, to be installed after scaffolding dismounting)</li> <li>• VDG system installed (except scale bar)</li> <li>• TTA installed</li> <li>• IR rig installed, connected and checked out (heaters and sensors)</li> <li>• Scaffolding up to level C installed, including He dewar tower</li> </ul>	
TP-A-2 during phase TS #0	<p>1. Initialise parallel activities for finalization of S/C installation in LSS as defined in the respective detailed procedures:</p> <p>electrical [AD18] (including CCS and TDH harness, TDH sensor and heaters checkout)</p> <p>ok at: ..... / .....</p>				
Test location: ETS / LSS		Shift leader:		PA / QA:	Date:

Step	Phase:	TP-A – Functional tests and S/C preparation		Remarks / NCR
	Test Floor: TCS, CVSE, Cryo	CCS: Instruments, PLM, SVM	DATA HANDLING FACILITY LSS CONTROL	
	CCS [AD19]  ok at: ..... / .....  CVSE [AD20]  ok at: ..... / .....  HACS [AD21] (including functional check)  ok at: ..... / .....  videogrammetry [AD22], [AD23]  ok at: ..... / .....  thermal setup [AD24]  ok at: ..... / .....			
	2. When CCS and electrical setup is completed: Give go-ahead to start ATC health check and functional dry-run           5. When Cryo-SCOE setup is completed: Perform Cryo-SCOE SFT  ok at: ..... / .....  6. Check synchronization of CCS and Facility clocks: Clock offset ( > 0 means CCS shows later time than TDH):  offset: .....  7. Perform cryostat preparation activities in parallel to all other activities up to end of TP-A-2: He II production and top-up acc. to [AD27] to HTT filling level 96% (-0/+2%) at 1.7±0.01 K	3. Upon go-ahead from shift leader: Execute section 8.0 of [AD2].  4. Start TB/TV dry-run according to red-lined functional test procedure (ACS HP-2-ASED-SD-0434)		
Test location:	ETS / LSS	Shift leader:	PA / QA:	Date:

Step	Phase:	TP-A – Functional tests and S/C preparation		Remarks / NCR
	Test Floor: TCS, CVSE, Cryo	CCS: Instruments, PLM, SVM	DATA HANDLING FACILITY LSS CONTROL	
8.	Determine filling level of HTT (L101 / L102):  HTT filling level: .....	10. On TCS request: Perform liquid level measurement according to section 9.4.1 of [AD2].		
9.	Determine required tilt angle for PPS start-up using table in section Annex H:  Required tilt angle: .....			
11.	<b>Perform KIP for go-ahead to stop Thermal Shields cooling</b> and start of uncooled preparation phase: Confirm closure of all preparation activities started in TP-A-2-T1  confirmed at: ..... / .....	16. At end of TB/TV dry run: Switch SVM to Launch Mode: Perform section 8.0.2 of [AD2].		
12.	Confirm successful closure of functional dry run	17. Perform final checks acc. to section 8.1 of [AD2]		
13.	Check He pumps			
14.	Check for open work or blocking points before LSS closure and pump-down			
15.	Call Key Point Meeting to give go-ahead.  go-ahead at: ..... / .....			
18.	Stop thermal shields cooling from external dewar.  stopped at: ..... / .....			
19.	Remove external shield cooling CVSE, attach SV121 catcher, safety line and V502 blind cap			
20.	Remove LOU N2 purge line and close MLI			
21.	Perform leak test of LSS internal safety line			
22.	Request PA to perform visual inspection			
23.	Request LSS to remove scaffolding			
				24. Upon request of shift leader: Remove scaffolding and integrate MLI patches on supports, bottom
Test location: ETS / LSS		Shift leader:	PA / QA:	Date:

Step	Phase:	TP-A – Functional tests and S/C preparation		Remarks / NCR
	Test Floor: TCS, CVSE, Cryo	CCS: Instruments, PLM, SVM	DATA HANDLING	
25. Open pump inlet valves to initiate <b>helium tubing evacuation</b>  pump opened at <b>T_pump</b> = ..... / .....				
26. Request CCS to <b>open external valves</b> V501 and V503 at <b>T_pump + 320 s</b> . New cryo valve states: Open: V501, V503, V504, V505 Closed: V103, V106, V105, V102, V104, V701, V702, TVQM3  ok at ..... / .....	28. On request of shift leader: Open external valves V501 and V503			
27. Monitor HST pressures P501, P502 to verify tubing evacuation to pressure below 10 mbar before T_pump + 1240 sec  ok at ..... / .....				
29. Open HTT outlet valve V104 and nozzle bypass valve TVQM3 (SPARE1) to start <b>pumping on HTT</b> . New cryo valve states: Open: V104, V501, V503, V504, V505, TVQM3 Closed: V103, V106, V105, V102, V701, V702  ok at ..... / .....	31. On request of shift leader: Open valves V104 and TVQM3 (SPARE1)			
30. Continue pumping on HTT for ~1 day, target mass flow rate ~10 mg/s. Pumping duration tbc during test by test conductor, depending on achieved mass flow rate.				
32. Close external vent line valves V501/V503, HTT outlet valve V104, and nozzle bypass valve TVQM3 to <b>stop pumping on HTT</b> . New cryo valve states: Open: V504, V505 Closed: V103, V106, V105, V102, V104, V701, V702, V501, V503, TVQM3  ok at ..... / ..... (Note: Helium tubing system is at underpressure from now on!)	33. On request of shift leader: Close valves V501/V503, V104 and TVQM3 (SPARE1)			
Test location: ETS / LSS	Shift leader:	PA / QA:	Date:	

Step	Phase:	TP-A – Functional tests and S/C preparation		Remarks / NCR
	Test Floor: TCS, CVSE, Cryo	CCS: Instruments, PLM, SVM	DATA HANDLING FACILITY LSS CONTROL	
35. Fill in <b>planned time</b> for following activities: <ul style="list-style-type: none"> <li>(Delayed) launch simulation planned at (55 hrs after end of TS cooling):  Planned T0 = ..... / .....</li> <li>Start of HTT heating planned at (T0 - 4 hrs):  ..... / .....</li> <li>1<sup>st</sup> switch-on of SPIRE LPU is not performed (27hrs before T0):  .....n/a.....</li> <li>2<sup>nd</sup> switch-on of SPIRE LPU planned at (2hrs before T0):  ..... / .....</li> </ul> 38. Request LSS to move and close cover 39. Remove telescope protective foil before closure  43. Request LSS to perform <b>Videogrammetry</b> measurement acc. to [AD23] 45. When 5m door is closed: Move helium pumping units 2 to basement (for nominal operation) and install vent-line to LSS flange on port A9 (in parallel to next activities); perform leak tests  46. Monitor HTT and Thermal Shields temperatures throughout non-cooled phase. Check for possible deviations wrt predictions and update planning for launch simulation (T0) accordingly.  47. Keep helium gas with pressure ~50 mbar above			34. Integrate VDG scale bar (as early as possible) 36. Clean chamber 37. Report readiness for LSS cover closure           40. Move LSS cover above LSS and suspend cover to crane 41. Close LSS cover after protective foil removal 42. Close 5m door  44. Perform Videogrammetry measurement acc. to [AD23]	
Test location:	ETS / LSS	Shift leader:	PA / QA:	Date:

Step	Phase:	TP-A – Functional tests and S/C preparation		Remarks / NCR
	Test Floor: TCS, CVSE, Cryo	CCS: Instruments, PLM, SVM	FACILITY DATA HANDLING      LSS CONTROL	
TS #1	ambient in safety line until start of chamber cool-down			
	48. Request LSS to perform tilting tests. During tilting to -Y down (positive tilt), observe PPS temperatures T111/T112 and record tilt angles: Return to vertical orientation after tilting verification.			49. On request and under control of shift leader: Perform tilting tests to +Y and -Y. Max. foreseen tilt angle: +/-20°
	Time                      Observation                      Tilt angle			max. +Y tilt angle:                      .....
	.....	.....	.....	max. -Y tilt angle:                      .....
	.....	.....	.....	Note: These measured max angles must not be exceeded throughout the test!
TS #2a	50. Switch off HACS to avoid overheating	53. Execute section 8.2.1 of [AD2]	54. Load alarm limits: General LOU SVM: T0	55. Install witness plates
	ok at:                      ..... / .....			
	51. Switch off VG902 before LSS pump-down to avoid ESD/corona effect:			
TS #2b	52. Request TDH to load SVM alarm limits T0			57. Close man door
	56. Request LSS to <b>start pump down</b> : latest time (launch simulation -8 hrs):			58. Pre-operations and switch ON instructions performed Ok at date / time: ..... / .....
	started at (date / time):			59. Confirm facility ready to start test Ok at date / time: ..... / .....
				60. On request of test conductor, start pumping down LSS chamber

Test location:	ETS / LSS	Shift leader:	PA / QA:	Date:
----------------	-----------	---------------	----------	-------

Step	Phase:	TP-A – Functional tests and S/C preparation		Remarks / NCR
	Test Floor: TCS, CVSE, Cryo	CCS: Instruments, PLM, SVM	DATA HANDLING FACILITY LSS CONTROL	
TS #2e	61. Monitor SVM temperatures. Expect exceedance of acceptance temperature limits on SVM power panel units 8 hrs after begin of pump down. If warning limits are reached: request Test Director decision to switch off S/C.  S/C off at: .....	62. On request of test director: Execute section 8.2.5 of [AD2] to switch off S/C		according to LSS procedure : ETS/INST/THER/211 63. Switch on door signs. Ok at date / time: .....
TS #2f	64. Initiate S/C switch ON 5 hrs before planned launch simulation. S/C switch on planned at: .....  S/C switched on at ..... (including loading of SVM TCT T1) 65. Request TDH to load SVM alarm limits T1	66. 5 hrs before planned launch simulation: Execute section 8.2.6 of [AD2] to switch on S/C 67. Start new CCS session.	68. Load alarm limits as defined in <b>Annex A:</b> General LOU SVM: T1	69. Install on doors the red warning notices. Ok at date / time: ..... 70. Ask security to change to safety configuration 3. Ok at date / time: ..... 71. Start chamber interseal pumps. Ok at date / time: ..... 72. Open V7. .... 73. Fill in pump down sheet. Ok at date / time: ..... 74. Start pumping with all CPS pumps. Ok at date / time: ..... 75. Open mass spectrometer valves (D7, B10). Ok at date / time: ..... 76. Start the two 20K cryo-pumps. Ok at date / time: ..... 77. When chamber pressure is 12 mbar, start roots 4. Ok at date / time: ..... 78. When chamber pressure reaches

Test location: ETS / LSS	Shift leader:	PA / QA:	Date:
--------------------------	---------------	----------	-------



Step	Phase:	TP-A – Functional tests and S/C preparation		Remarks / NCR
	Test Floor: TCS, CVSE, Cryo	CCS: Instruments, PLM, SVM	DATA HANDLING FACILITY LSS CONTROL	
			1x10-1. start Motion System interseal pumps and auxiliaries Ok at date / time: ..... / ..... 79. Start SNSE sectional flushing. Ok at date / time: ..... / ..... 80. Switch ON the 4 TM pumps at 5x10-2.mbar Ok at date / time: ..... / ..... 81. At 2x10-2 mbar, close V7 and cool down CP1. Ok at date / time: ..... / ..... 82. At 5x10-3 mbar open the 4 TM pumps HV valves ..... / ..... 83. Verify nominal operation of the 4 TM pumps. ..... / ..... 84. Cool down CP2. ..... / ..... 85. Stop roots 4 and CPS pumps. ..... / ..... 86. Start HP GN2 system.Mirror temp. 26° C. ..... / ..... 87. Switch ON mass spectrometers. ..... / ..... 88. Perform an He leak check on the 5m door shroud. ..... / ..... 89. Perform an He leak check on the MS shroud. ..... / ..... 90. Perform a leak check on flanges B2, B3, B4, B5, B6, B7, B10, A9, E11, E12, C2, C6.	
Test location:	ETS / LSS	Shift leader:	PA / QA:	Date:

Step	Phase:	TP-A – Functional tests and S/C preparation		Remarks / NCR
	Test Floor: TCS, CVSE, Cryo	CCS: Instruments, PLM, SVM	DATA HANDLING FACILITY LSS CONTROL	
			..... / ..... 91. If the 20K cryo-pumps are ready, open the VW 100 valves of cryo No 1 and No 2. ..... / ..... 92. Ask the Data Handling to set an alarm on the chamber pressure (1x10 <sup>-5</sup> mbar). ..... / ..... 93. Ask the Data Handling to set an alarm on CP1 and CP2 at -170° C. ..... / ..... 94. Start MS heater foils. ..... / ..... 95. Inform shift leader that pump down is completed	
TP-A-3 end of phase	1. Check Cryo Valve states at end of preparation phase: Open: V504, V505 Closed: V102, V104, V103, V106, V105, V701, V702, V501, V503, TVQM3 2. Verify that end-of-phase conditions are reached	1. Prepare EOP reports as defined in <b>Annex D</b> 2. Store CCS data (tables and rec files) on CD ROM Fill in: Date / Time of end: ..... / .....		

Test location:	ETS / LSS	Shift leader:	PA / QA:	Date:
----------------	-----------	---------------	----------	-------

I.2 TP-B – LEOP and SVM Cold

<b>Phase</b>	<b>TP-B - LEOP and SVM Cold</b>	<b>Type:</b> transient	<b>S/C Attitude</b>	<b>Tilt /°</b> : 0 at beginning, to be adjusted during phase
<b>Expected Duration / hrs</b>	148	<b>TTAS I/F</b> 20°C	+Z to collimator mirror	
<b>Objective</b>	<ul style="list-style-type: none"> <li>• Cool-down LSS shrouds (RT to LN2)</li> <li>• Verify safe PPS start-up and operation</li> <li>• Simulate the PLM in-orbit cool-down after launch</li> <li>• Confirm PLM TMM predictions of temperature peak in HTT</li> <li>• Verify PPS margin wrt peak temperature</li> <li>• Perform alignment measurements using the HACS</li> <li>• Verify the SVM pre-launch and launch sequence</li> <li>• Validate the SVM thermal control design changes between STM and FM configuration</li> <li>• validate the SVM thermal Mathematical Model (TMM) in steady state and transient conditions</li> <li>• validate the SVM thermal control design concept and thermal performances</li> </ul>			
<b>End of Phase Condition</b>	<ul style="list-style-type: none"> <li>• HTT temperature decreasing after peak value (T101, T102, T104, T105 drift &lt; 0 for 30 min)</li> <li>• PPS temperature margin checked</li> <li>• SVM TB-Cold conditions</li> </ul>			
<b>Important</b>	<p>Lift-off simulation to be initiated when the cryostat launch conditions are reached</p> <ul style="list-style-type: none"> <li>• Fill level 96% -0/+2%</li> <li>• HTT temperature &lt; 1.947 K</li> <li>• HOT temperature &lt; 35 K</li> <li>• OBA temperature &lt; 49.4 K</li> <li>• Shield 1 temperature &lt; 100.6 K</li> <li>• Shield 2 temperature &lt; 144 K</li> <li>• Shield 3 temperature &lt; 208 K (212 K tbc)</li> </ul> <p>HTT / HOT heating to be performed before lift-off simulation to reach the HTT / HOTS target temperature of 1.947 K at the same time (tbc during test).</p> <p>The launch sequence has to be followed closely, especially the time from external valves V501/V503 opening to PPS start-up, comprising opening of V103/V106 and tilting the S/C to immerse the PPS in the HTT liquid contents.. To operate correctly, the PPS shall be located 0 to 30 mm below the liquid surface. This is achieved by tilting the S/C by 1 (one) more degree when the PPS has already started. Correct operation of the PPS is confirmed when the temperature at the PPS outlet is lower than the temperature within the HTT, i.e. T111 &amp; T112 &lt; T101, T102, T104, T105</p> <p>SVM is switched from Launch Mode to Safe Mode, where a cold stabilization phase is performed, including the observation of TCS heater line cycling (to be recorded in section H.1.2) and the verification of the RCS design by tuning of test heaters</p> <p>The SVM is then switched to NOM mode, and the thermal stability is achieved in the various instrument prime / standby modes:</p> <ul style="list-style-type: none"> <li>• HIFI prime (check STB to prime switching), PACS/SPIRE OFF, wait for stabilisation</li> <li>• HIFI prime), PACS/SPIRE stand-by, wait for stabilisation</li> <li>• HIFI prime (control law dynamic verification), PACS/SPIRE stand-by, modify control law set point to check the dynamic response, wait for stabilisation</li> </ul> <p>After the stability phases, and near to the end of the PLM LEOP phase, the SVM cold TV part is performed including SVM unit functional tests and instrument SFTs.</p> <p>TP-B covers the test spec phases TS #2 (end) and TS #3 – TS #5.</p>			

Test location:	ETS / LSS	Shift leader:	PA / QA:	Date:
----------------	-----------	---------------	----------	-------

Step	Phase:	TP-B - LEOP and SVM Cold	FACILITY		Remarks / NCR
	TCS, CVSE, Cryo	CCS: Instruments, PLM, SVM	DATA HANDLING	LSS CONTROL	
TP-B-1 start of phase	<p>1. <b>Cryo Valve States:</b> (unchanged)</p> <p>V102: closed V104: closed V103: closed V106: closed V701: closed V702: closed V105: closed V501: closed V503: closed V504: open V505: open TV QM3: closed</p> <p>2. Request TDH to switch on test heaters</p>	<p>1. <b>Main Title:</b> Herschel FM TB/TV Test</p> <p>2. <b>Subtitle:</b> TP-B - LEOP and SVM Cold</p> <p>3. Start new section in Log Book</p> <p>4. Fill in: Date / Time of start: ..... / .....</p> <p>5. <b>CCS data logging:</b> Restart script "K102999ECVT035_ASDGEN_SCOE_CCU_LOG.tcl"; acquisition interval 30 sec.</p> <p>6. <b>SVM state and active PM:</b> LAM acc. to Sec. 3 of [AD1] CDMS: Launch / A ACMS: S.By / A TT&amp;C / XPND: OFF</p> <p>7. <b>Instrument states:</b> PACS: OFF SPIRE: OFF HIFI: OFF</p>	<p>1. <b>Main Title:</b> Herschel FM TB/TV Test</p> <p>2. <b>Subtitle:</b> TP-B - LEOP and SVM Cold</p> <p>3. <b>Alarm Limits:</b> Keep alarm limits as defined in <b>Annex A:</b> General LOU SVM: T1</p> <p>4. <b>Acquisition Interval:</b> 2 min</p> <p>5. <b>TDH Test Heaters:</b> <b>Switch on test heaters</b> TTAS 293K Test harness 293K SVM: Off IR rig: mode A, cold</p>	<p>1. <b>Sun Simulator:</b> off</p> <p>2. <b>Shrouds:</b> <u>C1 shroud:</u> ambient <u>C2 shroud:</u> ambient</p> <p>3. <b>Pressure:</b> &lt;10<sup>-5</sup> mbar</p> <p>4. <b>Spin Box:</b> <u>Temperature:</u> ambient <u>SB shroud:</u> ambient <u>Tilt angle:</u> 0°</p> <p>5. <b>5m door and Cover:</b> closed</p>	
TP-B-2 during phase (TS#2c)	<p>1. Request ETS to perform Videogrammetry measurement acc. to [RD2]</p> <p>2. Start VG902 measurements</p> <p>3. Verify He pumps status</p> <p>6. <b>Extrapolate OBA and thermal shields temperatures to update planned T0</b> (launch simulation to be performed when cryostat launch conditions are reached, see above).  Updated planned T0 = ..... / .....</p> <p>7. Extrapolate HTT temperature to updated T0.  Extrapolated HTT temp. at planned T0 = .....K</p>		<p>4. perform Videogrammetry measurement acc. to [RD2]</p>	<p>5. Be prepared to adjust tilt angle immediately on request of test conductor, independently from cool-down sequence</p>	

Test location: ETS / LSS	Shift leader:	PA / QA:	Date:
-----------------------------	---------------	----------	-------

Step	Phase:	TP-B - LEOP and SVM Cold		Remarks / NCR
	TCS, CVSE, Cryo	CCS: Instruments, PLM, SVM	FACILITY DATA HANDLING      LSS CONTROL	
TS #2g	8. Extrapolate HOT temperature to updated T0.  Extrapolated HOT temp. at planned T0 = .....K  9. If extrapolated <b>HTT</b> temperature is below 1.947 K: switch on / off H103 / H104 <b>to reach target temperature</b> at planned T0. Additional HTT temperature slope for 10 W heater power is ~28 mK/hr.  Expected heating power and duration = .....W. / .....min..  10. <b>Switch on</b> H103 / H104 heaters:  total power: .....W  Switched on at ..... / .....  11. <b>Switch off</b> H103 / H104 heaters:  Switched off at ..... / .....  HTT temperature: .....K	13. Perform 2 <sup>nd</sup> switch-ON of SPIRE LPU at (2hrs before delayed launch simulation): Perform Section 8.2.7 of [AD2]  ok at ..... / ..... (Note: Switch-off planned after 3.5 hrs. LPU duration shall not exceed the planned time!)  switch-off planned at ..... / .....		
	12. Request CCS to perform 2 <sup>nd</sup> switch-ON of SPIRE LPU at ( <b>2hrs before delayed launch simulation</b> ):  planned at ..... / ..... (Note: Switch-off planned after 3.5 hrs. LPU duration shall not exceed the planned time!)  14. When TS1 average is at <b>100.6 K</b> : Verify that cryostat is at launch condition as defined above  15. <b>Start launch simulation sequence</b>			
TS #2g	15. <b>Start launch simulation sequence</b>			
Test location:	ETS / LSS	Shift leader:	PA / QA:	Date:

Step	Phase:	TP-B - LEOP and SVM Cold	FACILITY		Remarks / NCR
	TCS, CVSE, Cryo	CCS: Instruments, PLM, SVM	DATA HANDLING	LSS CONTROL	
TS#2h	<p>16. Request LSS to start shrouds cool-down</p> <p>19. Note time stamp for lift-off simulation: "lift-off" at T0 = ..... / .....</p> <p>20. <b>Open external valves V501 and V503 at T0 + 320 s.</b> New cryo valve states: Open: V501, V503, V504, V505 Closed: V103, V106, V105, V102, V104, V701, V702, TVQM3  ok at ..... / .....</p> <p>21. <b>Open PPS valves V103 and V106 at T0 + 1240 s.</b> New cryo valve states: Open: V103, V106, V501, V503, V504, V505 Closed: V105, V102, V104, V701, V702, TVQM3  ok at ..... / .....</p> <p>25. Request CCS to disable Gyro / STR continuity check for tilting</p> <p>27. Request LSS to tilt S/C to perform <b>PPS start-up at T0 + 1494 s</b>  ok at ..... / .....</p> <p>29. Verify cryo valve states at end of PPS start-up: Open: V103, V106, V501, V503, V504, V505 Closed: V102, V104, V105, V701, V702, TVQM3</p> <p>30. Verify that vent line heaters H501 / H502 are off</p> <p>33. 30 min after end of tilting: Request CCS to enable</p>	<p>17. Execute section 8.2.8 of [AD2] to simulate launch phase and separation. <b>Perform switching of helium valves V501 &amp; V502, V103 &amp; V106 only upon explicit go-ahead from shift leader</b></p> <p>26. On request of shift leader: disable Gyro / STR continuity check acc to section section 9.3 of [AD2].</p> <p>34. On request of shift leader: enable Gyro / STR continuity</p>		<p>18. On request of shift leader: start cool-down operation acc. to applicable procedure: ETS/INST/THER/328</p> <p>22. Set LN2 tank pressure to 2 bar ..... / .....</p> <p>23. Check LN2 tank level: it must be above 50000 l. Transfer LN2 from another tank if level is below 50000 l. ..... / .....</p> <p>24. Check that all pumps are in nominal conditions. ..... / .....</p> <p>28. On request of shift leader: <b>Immediately adjust tilt angle</b>, rotation around S/C Z axis, telescope moves to the left as seen from 5m door (independent from cool-down sequence). Tilt direction: + Tilt speed: 1°/min</p> <p>31. Cool down C1+C2 sections (use LN2 pump 1 A). Ok at date / time: ..... / .....</p> <p>32. Verify nominal cool down of all shrouds. Ok at date / time: ..... / .....</p>	

Test location:	ETS / LSS	Shift leader:	PA / QA:	Date:
----------------	-----------	---------------	----------	-------

Step	Phase:	TP-B - LEOP and SVM Cold		Remarks / NCR	
	TCS, CVSE, Cryo	CCS: Instruments, PLM, SVM	FACILITY DATA HANDLING      LSS CONTROL		
TS #2i	<p>Gyro / STR continuity check</p> <p>35. Monitor PPS temperature drop (ok if T111 &lt; T101)</p> <p>36. Monitor HTT temperature &amp; pressure, PPS temperature gradient, and mass flow rate</p>	<p>check acc to section section 9.3 of [AD2].</p> <p>37. Switch OFF SPIRE LPU (1.5 hrs after delayed launch): Perform Section 8.2.9 of [AD2]</p> <p>ok at ..... / .....</p>		<p>38. Establish LN2 circulation in C1+C2. Ok at date / time: ..... / .....</p>	
TS #2j	<p>39. Adjust pressure in SV121 safety line to 55±5 mbar using the dedicated pump in the safety unit to avoid helium flow through SV121 when CVV is cold and O-ring gets leaky. Pressure will decrease to ~20 mbar with decreasing temperature in safety line.</p> <p>Ok at date / time: ..... / .....</p> <p>40. Keep pressure in safety line at HTT saturated vapour pressure ±3 mbar until CVV is recovered to ambient temperature (check on a daily basis, no adjustments foreseen).</p> <p>41. In parallel to next steps; When CVV temperature is below 210 K: Verify that alignment target is visible to HACS Ok at date / time: ..... / .....</p> <p>42. Start HACS measurements acc. to [RD1] (continue in next test phases until CVV reaches equilibrium temperature)</p> <p>45. Call Key Point Meeting for end of SVM LEOP mode.  Ok at date / time: ..... / .....</p> <p>46. Request TAS-F to <b>check Global Leak Test setup</b> by calibrated leak acc. to [AD30]; no waiting time, continue immediately with next steps.</p>	<p>43. After LPU switch off, start SVM LEOP mode: Perform Section 8.2.10 of [AD2] for mode transition.</p>		<p>44. Verify:</p> <ul style="list-style-type: none"> <li>- Chamber pressure is &lt; 1 x 10<sup>-5</sup> mbar</li> <li>- Chamber temperature is ≤100 K</li> <li>- GS position is 0° (S/C -Z to collimator mirror)</li> </ul>	
TS #3a	<p>47. Request TDH to load SVM alarm limits T2</p> <p>48. Request TDH to set SVM test heaters acc. to [AD25]</p>	<p>49. <b>Transition to System Safe Mode:</b> Perform Section 8.3.1 of [AD2] for transition to CDMS survival.</p>	<p>50. Load alarm limits as defined in <b>Annex A:</b> General LOU</p>		
Test location: ETS / LSS		Shift leader:	PA / QA:	Date:	

Step	Phase:	TP-B - LEOP and SVM Cold		Remarks / NCR	
	TCS, CVSE, Cryo	CCS: Instruments, PLM, SVM	FACILITY DATA HANDLING      LSS CONTROL		
TS #3b	<p>52. Monitor HTT filling level by integration of mass flow measurements and <b>adjust tilting angle every 24 hours</b> acc. to section H.1.1 (1° above table value); fill in section I.2.1. Note: Gyro/STR continuity check to be disabled before tilting operations, re-enable after 30 min!</p> <p>53. Monitor overall temperatures and test heater duty cycles. Adjust heater settings if necessary.</p> <p>56. Monitor SVM temperatures and adjust test heater power as appropriate</p> <p>58. Verify that all SVM TCS heater lines have switched during SVM cold phases. Fill in table in section H.1.2 throughout TP-B</p>	<p>54. Perform Section 8.3.2 of [AD2] for transition to ACMS survival.</p>	<p>SVM: T2</p> <p>51. Set SVM test heaters acc. to SVM TCS request</p> <p>57. Adjust test heater settings on request of thermal team during cool-down and stabilization</p>	<p>55. On request of shift leader: Perform daily adjustment of tilt angle</p>	
TS #3c	<p>59. Monitor SVM equilibrium temperature sensors and SVM TCS heater duty cycles</p> <p>60. Continue <b>SVM safe mode until stability criteria</b> are fulfilled: Temperature drift &lt;1°C/8 hrs for all SVM structure sensors.</p> <p>Reached at date / time: ..... / .....</p> <p>61. Call Key Point Meeting for <b>end of SVM safe mode phase:</b></p> <p>go-ahead at date / time: ..... / .....</p>	<p>62. Perform Section 8.3.3 of [AD2] for Safe Mode stabilization.</p>			
TS #3d	<p><b>63. Request CCS to start transition sequence to SVM TB cold</b></p>	<p>64. On TCS request: Transition to SAM: Perform section 8.3.4 of [AD2]</p>			
TS #3e		<p>65. Perform section 8.3.5 of [AD2] for transition to CMDU Nom</p>			
TS #3f		<p>66. Perform section 8.3.6 of [AD2] for transition to ACMS OCM</p>			
TS #3g		<p>67. Perform section 8.3.7 of [AD2] for transition to ACMS SCM</p>			
TS #3h		<p>68. Perform section 8.3.8 of [AD2] for CDMS reconfiguration B to A</p>			

Test location:	ETS / LSS	Shift leader:	PA / QA:	Date:
----------------	-----------	---------------	----------	-------



Step	Phase:	TP-B - LEOP and SVM Cold		Remarks / NCR
	TCS, CVSE, Cryo	CCS: Instruments, PLM, SVM	FACILITY DATA HANDLING      LSS CONTROL	
TS #3i		69. Perform section 8.3.9 of [AD2] for ACC reconfiguration B to A		
TS #3j		70. Perform section 8.3.10 of [AD2] for TTC reconfiguration to A		
TS #3k		71. Perform section 8.3.11 of [AD2] for transition to CMDS nom		
TS #3l		72. Perform section 8.3.12 of [AD2] for transition to ACMS OCM		
TS #3m		73. Perform section 8.3.13 of [AD2] for transition to ACSM SCM		
	75. Request CCS to initiate SVM for SVM TB cold (including loading of SVM TCT 2)	74. Start new CCS session		
TS #4a	77. Request TDH to set SVM test heaters acc. to [AD25] 78. Request TDH to load SVM alarm limits T3	76. Perform section 8.4 of [AD2] to initiate SVM for SVM TB cold (including loading of SVM TCT 2)	79. Set SVM test heaters acc. to SVM TCS request Load alarm limits as defined in <b>Annex A</b> : General LOU SVM: T3	
TS #4b	80. Start SVM TB cold phase: <b>HIFI Standby1 mode 1</b> 81. Continue SVM TB Cold <b>HIFI Standby1 mode 1</b> until stability criteria are fulfilled: Temperature drift <1°C/8 hrs for all SVM structure sensors.  Reached at date / time: ..... / .....	82. Perform section 8.4.1 of [AD2] to start SVM TB cold HIFI Standby1 mode 1 (PACS and SPIRE off) 83.		
TS #4c	84. Start SVM TB cold <b>HIFI prime mode 2</b> 85. Request TDH to load SVM alarm limits T4	87. Switch PACS and SPIRE to STB, HIFI remains in Standby1 mode: Perform Section 8.4.3 of [AD2] for mode transition	88. Load alarm limits as defined in <b>Annex A</b> : General LOU SVM: T4	
TS #4d	86. Continue SVM TB Cold HIFI Standby1 mode 2 until stability criteria are fulfilled: Temperature drift <1°C/8 hrs for all SVM structure sensors.  Reached at date / time: ..... / .....			
TS #4e	89. Request CCS to modify SVM TCS control law set	91. Modify SVM control law set points (TCT table) according to		

Test location:	ETS / LSS	Shift leader:	PA / QA:	Date:
----------------	-----------	---------------	----------	-------



Step	Phase:	TP-B - LEOP and SVM Cold		Remarks / NCR
	TCS, CVSE, Cryo	CCS: Instruments, PLM, SVM	FACILITY DATA HANDLING      LSS CONTROL	
98.	Continue LEOP simulation for 4 hrs to verify HTT temperature decrease with small nozzles  ok at ..... / .....			
<b>99. End of PLM LEOP simulation sequence</b>				
100.	Open external vent line valves V504 and V505 to activate large nozzle. New cryo valve states: Open: V103, V106, V501, V503, V504, V505 Closed: V102, V104, V105, V701, V702, TVQM3  ok at ..... / .....	102. Open external vent line valves V504 and V505 on TCS request		
101.	Perform <b>verification of PPS margin</b> wrt max. bath temperature: Heat HTT to max(2.1 K; peak temperature + 25 mK). Expected HTT temperature slope for 10 W heater power is ~18 mK/hr			
103.	Switch on H103 to 10W on Cryo SCOE	105. On TCS request: switch on H103, Power 10 W		
104.	Monitor PPS temperature sensors T111, T112 and HTT DLCM sensors T101, T102, T104, T105. Liquid break-through is indicated by a sudden increase of the PPS outlet sensors.  break-through at HTT temperature: .....K.  observed at ..... / .....			
106.	When HTT target temperature is reached: switch off H103 (even if no liquid break-through has occurred)	107. On TCS request: switch off H103		
108.	<b>Perform PPS sensors cross-check:</b>	111. On TCS request: close V103 and V106		
109.	Close PPS valves V103 / V106 to flood PPS and determine temperature sensors offset. New cryo valve states: Open: V501, V503, V504, V505			

Test location:	ETS / LSS	Shift leader:	PA / QA:	Date:
----------------	-----------	---------------	----------	-------

Step	Phase:	TP-B - LEOP and SVM Cold		Remarks / NCR
	TCS, CVSE, Cryo	CCS: Instruments, PLM, SVM	FACILITY DATA HANDLING      LSS CONTROL	
	<p>Closed: V103, V106, V102, V104, V105, V701, V702, TVQM3</p> <p>ok at ..... / .....</p> <p>110. Wait for stable reading of T111 / T112</p> <p>112. Request CCS to disable Gyro / STR continuity check for tilting</p> <p>114. Request LSS to return to vertical S/C orientation</p> <p>vertical at ..... / .....</p> <p>116. Request CCS to enable Gyro / STR continuity check 30 min after end of tilting:</p> <p>118. Perform <b>pressure sensors cross-check</b></p> <p>119. Close both manual He pump inlet valves Y0631 (including needle valves).</p> <p>120. Wait for stable readings (below svp) on all pressure sensors P502, P501, CVSE_002, CVSE_003, CVSE_005</p> <p>121. Record P506 analogue pressure reading:</p> <p>P506: .....mbar</p> <p>Date / time: ..... / .....</p> <p>122. Open HTT outlet valve V104 to get svp reference value. New cryo valve states: Open: V104, V501, V503, V504, V505 Closed: V103, V106, V102, V105, V701, V702, TVQM3</p> <p>ok at ..... / .....</p> <p>123.</p> <p>125. Wait for stable readings on all pressure sensors P502, P501, CVSE_002, CVSE_003, CVSE_005</p>	<p>113. On request of shift leader: disable Gyro / STR continuity check acc to section section 9.3 of [AD2].</p> <p>117. On request of shift leader: enable Gyro / STR continuity check acc to section section 9.3 of [AD2].</p> <p>124. On TCS request: open V104</p>	<p>115. On request of shift leader: <b>Return S/C to vertical.</b> Tilt speed: 1°/min</p>	

Test location:	ETS / LSS	Shift leader:	PA / QA:	Date:
----------------	-----------	---------------	----------	-------

Step	Phase:	TP-B - LEOP and SVM Cold		Remarks / NCR	
	TCS, CVSE, Cryo	CCS: Instruments, PLM, SVM	FACILITY DATA HANDLING      LSS CONTROL		
	126. Record P506 analogue pressure reading:  P506: .....mbar  Date / time: ..... / ..... 127. Record gas meter reading:  Gas meter: .....m <sup>3</sup> 128. Open both manual He pump inlet valves Y0631 to <b>restart pumping on HTT.</b> 129. Measure HTT contents via LLP:  L101/L102 reading: .....%  131.  132. Verify that coldest SVM equipment sensor is at cold predicted level including margins (values tbd by TASF)  coldest equipment sensor: .....  Temperature: .....  ok at ...../.....	130. On TCS request: Perform HTT Liquid Level Probes measurement (L101/L102) according to section 9.4.1 of [AD2].          133. Start new CCS session			
TS #5a	134. <b>In parallel to PLM LEOP phase:</b> Request CCS to <b>start SVM TV cold phase.</b> 135. Request TDH to load SVM alarm limits T5	136. On shift leader request: Start SVM TV cold, switch instruments to Stand By: Perform section 8.5.1 of [AD2]	137. Load alarm limits as defined in <b>Annex A:</b> General LOU SVM: T5		
TS #5b	138. Request TDH to change SVM test heaters mode acc. to [AD25]	139. Load TCT table "TCT 3 TV_COLD 5b-5f" 140. Perform section 8.5.2 of [AD2] for TV cold TT&C cell / A	141. Set SVM test heaters acc. to SVM TCS request		
TS #5c	142. Request TDH to load SVM alarm limits T6	143. Perform section 8.5.3 of [AD2] for TV cold TT&C cell / B	144. Load alarm limits as defined in <b>Annex A:</b> General LOU SVM: T6		
Test location: ETS / LSS		Shift leader:	PA / QA:	Date:	

Step	Phase:	TP-B - LEOP and SVM Cold	FACILITY		Remarks / NCR
	TCS, CVSE, Cryo	CCS: Instruments, PLM, SVM	DATA HANDLING	LSS CONTROL	
TS #5d		145. Perform section 8.5.4 of [AD2] for TV cold Power cell / A			
TS #5e		146. Perform section 8.5.5 of [AD2] for TV cold Power cell / B			
TS #5f		147. Perform section 8.5.6 of [AD2] for TV cold RW cell and STR1			
TS #5g		148. Load TCT table "TCT 4 TV_COLD 5g-5o, 6-9"			
		149. Perform section 8.5.7 of [AD2] for TV cold RW cell and STR2			
TS #5h	150. Request TDH to change SVM test heaters mode acc. to [AD25] 151. Request TDH to load SVM alarm limits T4	152. Inform TCS to change SVM test heaters mode 153. Perform section 8.5.8 of [AD2] for TV cold HIFI cells / A	154. Set SVM test heaters acc. to SVM TCS request 155. Load alarm limits as defined in <b>Annex A:</b> General LOU SVM: T4		
TS #5i	156. Note: Do not change tilt angle during HIFI test!	157. Perform section 8.5.9 of [AD2] for TV cold HIFI cells / B			
TS #5j		158. Perform section 8.5.10 of [AD2] for TV cold PACS cell / A			
TS #5k		159. Perform section 8.5.11 of [AD2] for TV cold PACS cell / B			
TS #5l		160. Perform section 8.5.12 of [AD2] for TV cold SPIRE cell / A			
TS #5m		161. Perform section 8.5.13 of [AD2] for TV cold SPIRE cell / B			
TS #5n	162. Note: During the lock threshold test and the TC threshold test, the commandability and observability of the S/C can be lost for up to 3 hours.	163. Perform section 8.5.14 of [AD2] for TT&C test (Expected duration 16 hrs)			
TS #5o	164. Wait for end of PLM Rapid Cool-down phase. <b>165. End of SVM TV cold sequence, overlap with PLM Rapid cool-down expected.</b> 166. Verify that all SVM TCS heater lines have cycled.				

Test location:	ETS / LSS	Shift leader:	PA / QA:	Date:
----------------	-----------	---------------	----------	-------

Step	Phase:	TP-B - LEOP and SVM Cold	FACILITY		Remarks / NCR
	TCS, CVSE, Cryo	CCS: Instruments, PLM, SVM	DATA HANDLING	LSS CONTROL	
TP-B-3 end of phase	1. Verify that end-of-phase conditions are reached: <ul style="list-style-type: none"> <li>• PLM LEOP finished</li> <li>• End of SVM TV-cold expected during PLM Rapid Cool-down</li> </ul> 3. Convene Key Point Meeting	2. Prepare EOP reports as defined in Annex D  4. Store CCS data (tables and rec files) on CD ROM  5. Fill in: Date / Time of end: ..... / .....			

Test location:	ETS / LSS	Shift leader:	PA / QA:	Date:
----------------	-----------	---------------	----------	-------





**I.3 TP-C – PLM Rapid Cool-Down and SVM heat-up**

<b>Phase</b>	<b>TP-C - PLM Rapid Cool-Down and SVM heat-up</b>	<b>Type:</b> transient	<b>S/C Attitude</b>	<b>Tilt /° :</b> 0 at beginning, to be adjusted during phase to immerse PPS
<b>Expected Duration / hrs</b>	56	<b>TTAS I/F</b> 20°C	+Z to collimator mirror	
<b>Objective</b>	<ul style="list-style-type: none"> <li>• Bring HTT to required instrument TV temperature as quickly as possible and stabilize L0/L1/L2 temperatures</li> <li>• Verify PPS margin wrt maximum mass flow rate at HTT temperature 2.05 K</li> <li>• Finish SVM TV cold phase</li> <li>• Bring SVM to hot case temperatures</li> <li>• Perform DLCM operation</li> <li>• Measure HTT contents with LLP (initial measurement performed at end of previous phase)</li> </ul>			
<b>End of Phase Condition</b>	<ul style="list-style-type: none"> <li>• HTT temperature ~1.85 K</li> <li>• HTT temperature drift &lt; 0.21 K/hr</li> <li>• L1 temperature drift &lt; 0.21 K/hr</li> <li>• L2 temperature drift &lt; 0.54 K/hr</li> </ul>			
<b>Important</b>	<p>During RC, when HTT has reached 2.05K (tbc), perform PPS maximum flow rate verification using the nozzles bypass and pump inlet valve adjustment, starting from almost closed pump inlet to fully open to simulate decreasing external vent line flow impedance.</p> <p>TP-C covers the test spec phase TS #6.</p>			

Test location: ETS / LSS	Shift leader:	PA / QA:	Date:
-----------------------------	---------------	----------	-------

Step	Phase:	TP-C – PLM Rapid Cool-Down and SVM heat-up		Remarks / NCR	
	TCS, CVSE, Cryo	CCS: Instruments, PLM, SVM	FACILITY DATA HANDLING      LSS CONTROL		
TP-C-1 start of phase	<p>1. <b>Cryo Valve States:</b> (unchanged)</p> <p>V102: closed V104: open V103: closed V106: closed V701: closed V702: closed V105: closed V501: open V503: open V504: open V505: open TV QM3: closed</p>	<p>1. <b>Main Title:</b> Herschel FM TB/TV Test</p> <p>2. <b>Subtitle:</b> TP-C - PLM Rapid Cool-Down and SVM heat-up</p> <p>3. Start new section in Log Book</p> <p>4. Fill in: Date / Time of start: ..... / .....</p> <p>5. <b>CCS data logging:</b> Restart script "K102999ECVT035_ASDGEN_SCOE_CCU_LOG.tcl"; acquisition interval 30 sec.</p>	<p>1. <b>Main Title:</b> Herschel FM TB/TV Test</p> <p>2. <b>Subtitle:</b> TP-C - PLM Rapid Cool-Down and SVM heat-up</p> <p>3. <b>Alarm Limits:</b> Keep alarm limits as defined in <b>Annex A</b></p> <p>4. <b>Acquisition Interval:</b> 2 min</p> <p>5. <b>TDH Test Heaters:</b> unchanged TTAS 293K (tbc) Test harness 293K (tbc) SVM: unchanged IR rig: mode A, cold</p>	<p>1. <b>Sun Simulator:</b> off</p> <p>2. <b>Shrouds:</b> C1 shroud: LN2 C2 shroud: LN2</p> <p>3. <b>Pressure:</b> &lt;10<sup>-5</sup> mbar</p> <p>4. <b>Spin Box:</b> Temperature: 293 K SB shroud: LN2 Tilt angle: &gt;0° (unchanged)</p> <p>5. <b>5m door and Cover:</b> closed</p>	
TP-C-2 during phase; TS #6a  TS #6c	<p>1. Switch instruments to STB</p> <p>3. Request CCS to load SVM TCS TCT table 5</p> <p>5. Request CCS to perform DLCM and LLP measurement</p> <p>L101/L102 reading: ...../.....%</p> <p>7. Open nozzle bypass valve TVQM3 to <b>initiate HTT rapid cool-down</b>. New cryo valve states: Open: V104, V501, V503, V504, V505, TVQM3 Closed: V103, V106, V102, V105, V701, V702</p> <p>ok at ..... / .....</p> <p>8. Monitor HTT, OBA, TS temperatures and mass flow rate. Perform PPS mass flow rate margin test when HTT is at 2.05 K (step TP-C-2-T15)</p> <p>9. If mass flow rate exceeds 100 mg/s, operate pump inlet valves to limit mass flow to 100 mg/s maximum (to avoid undershoot in thermal shields temperatures)</p>	<p>2. Switch FPUs to STB: Perform Section 8.6.1 of [AD2]</p> <p>4. On TCS request: load SVM TCS TCT table 5.</p> <p>6. On TCS request: Execute DLCM measurements acc. to section 8.6.3 of [AD2]</p> <p>10. Open nozzle bypass valve TVQM3 (SPARE1 on Cryo-SCOE)</p>			
Test location:	ETS / LSS	Shift leader:	PA / QA:	Date:	

Step	Phase:	TP-C – PLM Rapid Cool-Down and SVM heat-up		Remarks / NCR
	TCS, CVSE, Cryo	CCS: Instruments, PLM, SVM	FACILITY DATA HANDLING      LSS CONTROL	
TS #6b	11. Request TDH to set SVM test heaters acc. to [AD25] 12. Request TDH to switch to TTAS-B test heater settings  15. When HTT has reached 2.05 K: <b>Verify PPS mass flow rate margin. Note: No change of tilt angle during HIFI SFT!</b> 16. Monitor PPS operation (T111, T112 vs. T101, T102, T104, T105) throughout check  17. Close both manual He pump inlet ball valves Y0631, keeping one needle valve fully open 18. Open PPS outlet valves V103 & V106, close HTT outlet V104. New cryo valve states: Open: V103, V106, V501, V503, V504, V505, TVQM3 Closed: V104, V102, V105, V701, V702  ok at ..... / ..... 19. Wait for 10 min to dry out PPS 21. Request CCS to disable Gyro / STR continuity check for tilting 23. Inform LSS to expect rising LSS pressure due to temperature rise on test tubing 24. Request LSS to tilt S/C for PPS immersion. Assess expected tilt angle from section H.1.1. and liquid level of step TP-C-B5  required tilt angle: ..... 26. Monitor PPS temperature drop (ok if T111 < T101) 27. Verify correct PPS operation for 10 min 28. Increase mass flow rate slowly by slow opening of pump inlet ball valve Y0631 while monitoring PPS operation	20. On TCS request: Open valves V103 and V106; close valve V104  22. On request of shift leader: disable Gyro / STR continuity check acc to section section 9.3 of [AD2].	13. Set SVM test heaters acc. to SVM TCS request 14. Switch TTAS test heaters to mode TTAS-B  25. On request of shift leader: <b>adjust tilt angle</b> , rotation around S/C Z axis, telescope moves to the left. Tilt direction: + Tilt speed: 1°/min	

Test location:	ETS / LSS	Shift leader:	PA / QA:	Date:
----------------	-----------	---------------	----------	-------

Step	Phase:	TP-C – PLM Rapid Cool-Down and SVM heat-up		Remarks / NCR
	TCS, CVSE, Cryo	CCS: Instruments, PLM, SVM	FACILITY DATA HANDLING      LSS CONTROL	
29.	If PPS outlet temperature rises: Note maximum achieved mass flow rate before break-through:  max mass flow: .....mg/s			
30.	Continue until pump inlet valves are fully open			
31.	Close PPS outlet valves V103 / V106, flooding the PPS; New cryo valve states: Open: V501, V503, V504, V505, TVQM3 Closed: V103, V106, V104, V102, V105, V701, V702  ok at ..... / .....	32. On TCS request: close valves V103 and V106		
33.	<b>End of PPS margin verification, resume HTT rapid cool-down</b>			
34.	Open HTT outlet V104; new cryo valve states: Open: V104, V501, V503, V504, V505, TVQM3 Closed: V103, V106, V102, V105, V701, V702  ok at ..... / .....	35. On TCS request: close valve V104		
36.	Request LSS to return to 0° tilt angle  vertical at ..... / .....			37. On TCS request: return to vertical position (0° tilt) Tilt speed: 1°/min
38.	Request CCS to enable Gyro / STR continuity check 30 min after end of tilting:	39. On request of shift leader: enable Gyro / STR continuity check acc to section section 9.3 of [AD2].		
40.	(empty)			
41.	Monitor HTT, OBA, TS temperatures and mass flow rate.			
42.	If mass flow rate exceeds 100 mg/s, operate pump inlet valves to limit mass flow to 100 mg/s maximum (to avoid undershoot in thermal shields temperatures)			
43.	Continue rapid cool-down until HTT temperature (T101, T102, T104, T105) is <1.85 K			

Test location: ETS / LSS	Shift leader:	PA / QA:	Date:
-----------------------------	---------------	----------	-------

Step	Phase:	TP-C – PLM Rapid Cool-Down and SVM heat-up	FACILITY		Remarks / NCR
	TCS, CVSE, Cryo	CCS: Instruments, PLM, SVM	DATA HANDLING	LSS CONTROL	
TS #6d	<p>44. Determine filling level of HTT (L101/L102):</p> <p>HTT filling level: ...../.....%</p> <p>45. <b>End of rapid HTT cool-down.</b></p> <p>47. Inform LSS to expect rising LSS pressure due to temperature rise on test tubing</p> <p>48. Adjust mass flow rate to 4.05±0.1 mg/s (equilibrium mdot) by closing He pump inlet ball valves and partial opening of needle valves.</p> <p>49. Request TDH to perform <b>videogrammetry measurement</b></p> <p>51. Wait until temperature and stability criteria are fulfilled; adjust mass flow rate if necessary:</p> <ul style="list-style-type: none"> <li>HTT temperature &lt; 1.85 K; drift &lt; 210 mK / 1h</li> <li>Level 1 temperature &lt; 5 K; drift &lt; 210 mK / 1h</li> <li>Level 2 temperature &lt; 12 K; drift &lt; 540 mK / 1h</li> </ul>	<p>46. On TCS request: perform liquid level probes measurement according to section 9.4.1 of [AD2].</p>	<p>50. On TCS request: perform videogrammetry measurement</p>		
TP-C-3 end of phase	<p>1. Verify that end-of-phase conditions are reached:</p> <ul style="list-style-type: none"> <li>HTT rapid cool-down finished</li> <li></li> </ul> <p>3. Fill in:</p> <p>Date / Time of end: ..... / .....</p> <p>4. Convene TRB</p>	<p>2. Prepare EOP reports as defined in <b>Annex D</b></p> <p>5. Store CCS data (tables and rec files) on CD ROM</p>			

Test location:	ETS / LSS	Shift leader:	PA / QA:	Date:
----------------	-----------	---------------	----------	-------

I.4 TP-D – TV Phase HIFI 0-1

<b>Phase</b>	TP-D – TV Phase HIFI 0-1	<b>Type:</b> stable	<b>S/C Attitude</b>	<b>Tilt /° :</b> 0 to -20
<b>Expected Duration / hrs</b>	11	<b>TTAS I/F</b> 20°C	+Z to collimator mirror	
<b>Objective</b>	<ul style="list-style-type: none"> <li>• Measure chopper speed</li> <li>• Measure the mixer I.V curves</li> <li>• Measure noise added by the IF chain</li> <li>• Optimize diplexer position for LO coupling + coarse VD2</li> </ul>			
<b>End of Phase Condition</b>	<ul style="list-style-type: none"> <li>• HIFI tests completed</li> </ul>			
<b>Important</b>	<p>Throughout the instruments TV test phases, the spacecraft will remain tilted to -20° to allow cooler recycling, and to maintain stable conditions as far as possible.</p> <p>After the initial stabilization phase and a first planned adjustment on the second day, the mass flow from the HTT is left drifting as long as the HTT temperature slope does not exceed ±3 mK/day.</p> <p>TP-D covers the test spec phase TS #7.</p>			

Test location: ETS / LSS	Shift leader:	PA / QA:	Date:
-----------------------------	---------------	----------	-------

Step	Phase:	TP-D – TV Phase HIFI 0-1	FACILITY		Remarks / NCR
	TCS, CVSE, Cryo	CCS: Instruments, PLM, SVM	DATA HANDLING	LSS CONTROL	
TP-D-1 start of phase	<p>1. <b>Cryo Valve States:</b> (unchanged) Open: V104, V501, V503, V504, V505, TVQM3 Closed: V103, V106, V102, V105, V701, V702</p>	<p>1. <b>Main Title:</b> Herschel FM TB/TV Test 2. <b>Subtitle:</b> TP-D – TV Phase HIFI 0-1 3. Start new section in Log Book 4. Fill in: Date / Time of start: ..... / ..... 5. <b>CCS data logging:</b> Restart script "K102999ECVT035_ASDGEN_SCOE_CCU_LOG.tcl"; acquisition interval 30 sec.</p>	<p>1. <b>Main Title:</b> Herschel FM TB/TV Test 2. <b>Subtitle:</b> TP-D – TV Phase HIFI 0-1 3. <b>Alarm Limits:</b> Keep alarm limits as defined in <b>Annex A</b> 4. <b>Acquisition Interval:</b> 2 min 5. <b>TDH Test Heaters:</b> unchanged TTAS 293K (tbc) Test harness 293K (tbc) SVM: unchanged IR rig: mode A, cold</p>	<p>1. <b>Sun Simulator:</b> off 2. <b>Shrouds:</b> C1 shroud: LN2 C2 shroud: LN2 3. <b>Pressure:</b> &lt;10<sup>-5</sup> mbar 4. <b>Spin Box:</b> Temperature: 293 K SB shroud: LN2 Tilt angle: 0° 5. <b>5m door and Cover:</b> closed</p>	
TP-D-2 during phase	<p>1. Monitor temperatures and test heater settings 2. Monitor HTT temperature and mass flow rate; manually adjust mass flow rate if HTT temperature drift exceeds ±3 mK/day throughout phase. 3. Monitor PLM external equilibrium temperature sensors throughout phase. 6. Request CCS to disable Gyro / STR continuity check for tilting 8. Request LSS to tilt S/C to -20° to enable cooler recycling.  -20° reached at ..... / .....</p>	<p>4. Start new CCS session 5. Monitor HK data. Inform shift leader and instruments teams of any red out-of-limit values throughout phase. 7. On request of shift leader: disable Gyro / STR continuity check acc to section section 9.3 of [AD2].</p>		<p>9. On request of shift leader: <b>adjust tilt angle to -20°</b> for instruments testing (telescope moves to the right as seen from 5m door) Tilt speed: 1°/min (Notes: - S/C remains at -20° tilt angle throughout instruments testing phase - Do not exceed the maximum tilt angle determined in the tilting verification!)</p>	

Test location:	ETS / LSS	Shift leader:	PA / QA:	Date:
----------------	-----------	---------------	----------	-------

Step	Phase:	TP-D – TV Phase HIFI 0-1	FACILITY		Remarks / NCR
	TCS, CVSE, Cryo	CCS: Instruments, PLM, SVM	DATA HANDLING	LSS CONTROL	
TS #7a TS #7b	10. Request CCS to enable Gyro / STR continuity check 30 min after end of tilting:  13. Request CCS to perform <b>HIFI TV phase 0-1</b> sequence	11. On request of shift leader: enable Gyro / STR continuity check acc to section section 9.3 of [AD2].  12. HIFI team: implement CUS update with new safety tables (tbc by HIFI)  14. Perform <b>HIFI TV phase 0-1</b> acc. to section 8.7of [AD2].  15. Switch HIFI to stand-by mode acc. to section 8.7 of [AD2]. (if not already included in previous script??)			
TP-D-3 end of phase	1. Verify that end-of-phase conditions are reached:  3. Fill in: Date / Time of end: ..... / .....  4. Convene Key Point Meeting	2. Prepare EOP reports as defined in <b>Annex D</b>  5. Store CCS data (tables and rec files) on CD ROM			

Test location:	ETS / LSS	Shift leader:	PA / QA:	Date:
----------------	-----------	---------------	----------	-------



**I.5 TP-E – Combined Instruments TV**

<b>Phase</b>	<b>TP-E – Combined Instruments TV</b>	<b>Type:</b> stable	<b>S/C Attitude</b>	<b>Tilt /° : -20</b>
<b>Expected Duration / hrs</b>	8	<b>TTAS I/F</b> 20°C	+Z to collimator mirror	
<b>Objective</b>	<ul style="list-style-type: none"> <li>Activities have been deleted from this test phase. Wait for HIFI readiness for next phase</li> </ul>			
<b>End of Phase Condition</b>	<ul style="list-style-type: none"> <li>HIFI ready for next phase</li> </ul>			
<b>Important</b>	TP-E covers the test spec phase TS #8.			

Test location: ETS / LSS	Shift leader:	PA / QA:	Date:
-----------------------------	---------------	----------	-------

Step	Phase:	TP-E – Combined Instruments TV	FACILITY		Remarks / NCR
	TCS, CVSE, Cryo	CCS: Instruments, PLM, SVM	DATA HANDLING	LSS CONTROL	
TP-E-1 start of phase	<ol style="list-style-type: none"> <li><b>Cryo Valve States:</b> (unchanged) Open: V104, V501, V503, V504, V505, TVQM3 Closed: V103, V106, V102, V105, V701, V702</li> </ol>	<ol style="list-style-type: none"> <li><b>Main Title:</b> Herschel FM TB/TV Test</li> <li><b>Subtitle:</b> TP-E – Combined Instruments TV</li> <li>Start new section in Log Book</li> <li>Fill in: Date / Time of start: ..... / .....</li> <li><b>CCS data logging:</b> Keep script "K102999ECVT035_ASDGEN_SCOE_CCU_LOG.tcl" running from previous phase; acquisition interval 30 sec.</li> </ol>	<ol style="list-style-type: none"> <li><b>Main Title:</b> Herschel FM TB/TV Test</li> <li><b>Subtitle:</b> TP-E – Combined Instruments TV</li> <li><b>Alarm Limits:</b> Keep alarm limits as defined in Annex A</li> <li><b>Acquisition Interval:</b> 2 min</li> <li><b>TDH Test Heaters:</b> unchanged TTAS 293K (tbc) Test harness 293K (tbc) SVM: mode H (tbd) IR rig: mode A, cold</li> </ol>	<ol style="list-style-type: none"> <li><b>Sun Simulator:</b> off</li> <li><b>Shrouds:</b> C1 shroud: LN2 C2 shroud: LN2</li> <li><b>Pressure:</b> &lt;10<sup>-5</sup> mbar</li> <li><b>Spin Box:</b> Temperature: 293 K SB shroud: LN2 Tilt angle: -20°</li> <li><b>5m door and Cover:</b> closed</li> </ol>	
TP-E-2 during phase	<ol style="list-style-type: none"> <li>Monitor temperatures and test heater settings</li> <li>Monitor HTT temperature and mass flow rate; manually adjust mass flow rate if HTT temperature drift exceeds ±3 mK/day throughout phase.</li> <li>Monitor PLM external equilibrium temperature sensors throughout phase.</li> <li>Request CCS to enable TCS FDIR line upon SVM TCS directives</li> </ol>	<ol style="list-style-type: none"> <li>Start new CCS session</li> <li>Monitor HK data. Inform shift leader and instruments teams of any red out-of-limit values throughout phase.</li> <li>Enable TCS FDIR line upon SVM TCS directives</li> </ol>			
TS #8a	<ol style="list-style-type: none"> <li>Wait for 8 hours / HIFI to prepare next test phase</li> </ol>				
TP-E-3 end of phase	<ol style="list-style-type: none"> <li>Fill in: Date / Time of end: ..... / .....</li> </ol>	<ol style="list-style-type: none"> <li>Store CCS data (tables and rec files) on CD ROM</li> </ol>			
Test location: ETS / LSS		Shift leader:	PA / QA:	Date:	

Step	Phase:	TP-E – Combined Instruments TV	FACILITY		Remarks / NCR
	TCS, CVSE, Cryo	CCS: Instruments, PLM, SVM	DATA HANDLING	LSS CONTROL	
2.	Convene Key Point Meeting				

Test location:	ETS / LSS	Shift leader:	PA / QA:	Date:
----------------	-----------	---------------	----------	-------

**I.6 TP-F – HIFI TV Test 2**

<b>Phase</b>	<b>TP-F – HIFI TV Test 2</b>	<b>Type:</b> stable	<b>S/C Attitude</b>	<b>Tilt /° : -20</b>
<b>Expected Duration / hrs</b>	28 (acc. to [AD4]; 18 acc. to [AD10])	<b>TTAS I/F</b> 20°C	+Z to collimator mirror	
<b>Objective</b>	<ul style="list-style-type: none"> <li>Optimize diplexer position for signal coupling from diplexer scans with hot/cold</li> <li>Get fine LOU VD2 optimum for mixer pumping from vector scans</li> </ul>			
<b>End of Phase Condition</b>	<ul style="list-style-type: none"> <li>SPIRE/PACS combined tests completed</li> </ul>			
<b>Important</b>	TP-F covers the test spec phase TS #9.			

Test location: <b>ETS / LSS</b>	Shift leader:	PA / QA:	Date:
------------------------------------	---------------	----------	-------

Step	Phase:	TP-F – HIFI TV Test 2		Remarks / NCR	
	TCS, CVSE, Cryo	CCS: Instruments, PLM, SVM	FACILITY DATA HANDLING      LSS CONTROL		
TP-F-1 start of phase	<p>1. <b>Cryo Valve States:</b> (unchanged) Open: V104, V501, V503, V504, V505, TVQM3 Closed: V103, V106, V102, V105, V701, V702</p>	<p>1. <b>Main Title:</b> Herschel FM TB/TV Test 2. <b>Subtitle:</b> TP-F – HIFI TV Test 2 3. Start new section in Log Book 4. Fill in: Date / Time of start: ..... / ..... 5. <b>CCS data logging:</b> Keep script "K102999ECVT035_ASDGEN_SCOE_CCU_LOG.tcl" running from previous phase; acquisition interval 30 sec.</p>	<p>1. <b>Main Title:</b> Herschel FM TB/TV Test 2. <b>Subtitle:</b> TP-F – HIFI TV Test 2 3. <b>Alarm Limits:</b> Keep alarm limits as defined in <b>Annex A</b> 4. <b>Acquisition Interval:</b> 2 min 5. <b>TDH Test Heaters:</b> unchanged TTAS                    293K (tbc) Test harness        293K (tbc) SVM:                    mode H (tbd) IR rig:                   mode A, cold</p>	<p>1. <b>Sun Simulator:</b> off 2. <b>Shrouds:</b> <u>C1 shroud:</u> LN2 <u>C2 shroud:</u> LN2 3. <b>Pressure:</b> &lt;10<sup>-5</sup> mbar 4. <b>Spin Box:</b> <u>Temperature:</u> 293 K <u>SB shroud:</u> LN2 <u>Tilt angle:</u> -20° 5. <b>5m door and Cover:</b> closed</p>	
TP-F-2 during phase	<p>1. Monitor temperatures and test heater settings 2. Monitor HTT temperature and mass flow rate; manually adjust mass flow rate if HTT temperature drift exceeds ±3 mK/day throughout phase. 3. Monitor PLM external equilibrium temperature sensors throughout phase. 6. Perform planned adjustment of mass flow rate to reduce HTT temperature drift 24-48 hrs after first adjustment (tbc during test)</p>	<p>4. Start new CCS session 5. Monitor HK data. Inform shift leader and instruments teams of any red out-of-limit values throughout phase. 7. HIFI team: implement updated look-up table for diplexer, IF2 drain currents, LOU VD2 (tbc by HIFI)</p>			
TS #9a	<p>8. Request CCS to perform <b>HIFI test 2</b> sequence 9. Within 15 minutes after HIFI units switch-on: SVM TCS to request CCS to correct UIUs for all HIFI units</p>	<p>10. Perform <b>HIFI test 2 sequence</b> acc. to section 8.9 of [AD2]. 11. On SVM TCS request: correct UIUs for all HIFI units.</p>			
TS #9b	<p>13. Request CCS to disable FDIR</p>	<p>12. Switch HIFI to stand-by mode acc. to section 8.9 of [AD2]. (if not already included in previous script) 14. On SVM TCS request: disable FDIR</p>			

Test location:	ETS / LSS	Shift leader:	PA / QA:	Date:
----------------	-----------	---------------	----------	-------

Step	Phase:	TP-F – HIFI TV Test 2	FACILITY		Remarks / NCR
	TCS, CVSE, Cryo	CCS: Instruments, PLM, SVM	DATA HANDLING	LSS CONTROL	
TP-F-3 end of phase	1. Verify that end-of-phase conditions are reached:  3. Fill in: Date / Time of end: ..... / .....  4. Convene Key Point Meeting	2. Prepare EOP reports as defined in <b>Annex D</b>  5. Store CCS data (tables and rec files) on CD ROM			

Test location: ETS / LSS	Shift leader:	PA / QA:	Date:
-----------------------------	---------------	----------	-------

**I.7 TP-G – SPIRE TV and SVM TB Hot**

<b>Phase</b>	<b>TP-G – SPIRE TV and SVM TB Hot</b>	<b>Type:</b> stable	<b>S/C Attitude</b>	<b>Tilt /° : -20</b>
<b>Expected Duration / hrs</b>	48	<b>TTAS I/F</b> 20°C	+Z to collimator mirror	
<b>Objective</b>	<ul style="list-style-type: none"> <li>• Perform functional/performance test on SPIRE</li> <li>• SVM TB Hot test STR validation (2 STRs in parallel)</li> <li>• STR validation (2 STRs in parallel)</li> </ul>			
<b>End of Phase Condition</b>	<ul style="list-style-type: none"> <li>• SPIRE tests completed</li> </ul>			
<b>Important</b>	<p>The SPIRE TV test sequence consist of the following steps (not given in chronological sequence below):</p> <ul style="list-style-type: none"> <li>• Cooler recycle (automatic)</li> <li>• Photometer Thermal Control (PTC) Headroom Characterisation</li> <li>• Photometer Thermal Control (PTC) Verification</li> <li>• PCAL Photometer Characterisation</li> <li>• SCAL Photometric Verification</li> <li>• PCAL Spectrometer Characterisation</li> <li>• Photometer scan mode POF5</li> <li>• Photometer chop/jiggle mode POF2</li> <li>• SPEC high resolution mode SOF1 Simulation</li> <li>• 300 mK Stage Decontamination</li> <li>• Photometer Ambient Background Verification</li> <li>• Spectrometer Ambient Background Verification</li> </ul> <p>Cryo Cooler recycling shall not be performed during the SVMT TB HOT DTCP mode. Expected cooler hold time is 21 hrs.</p> <p>TP-G covers the test spec phase TS #10.</p>			

Test location: ETS / LSS	Shift leader:	PA / QA:	Date:
-----------------------------	---------------	----------	-------

Step	Phase:	TP-G – SPIRE TV and SVM TB Hot		Remarks / NCR	
	TCS, CVSE, Cryo	CCS: Instruments, PLM, SVM	FACILITY DATA HANDLING      LSS CONTROL		
TP-G-1 start of phase	<p>1. <b>Cryo Valve States:</b> (unchanged) Open: V104, V501, V503, V504, V505, TVQM3 Closed: V103, V106, V102, V105, V701, V702</p>	<p>1. <b>Main Title:</b> Herschel FM TB/TV Test 2. <b>Subtitle:</b> TP-G – SPIRE TV and SVM TB Hot 3. Start new section in Log Book 4. Fill in: Date / Time of start: ..... / ..... 5. <b>CCS data logging:</b> Restart script "K102999ECVT035_ASDGEN_SCOE_CCU_LOG.tcl" Acquisition interval 30 sec.</p>	<p>1. <b>Main Title:</b> Herschel FM TB/TV Test 2. <b>Subtitle:</b> TP-G – SPIRE TV and SVM TB Hot 3. <b>Alarm Limits:</b> Keep alarm limits as defined in <b>Annex A</b> 4. <b>Acquisition Interval:</b> 2 min 5. <b>TDH Test Heaters:</b> unchanged TTAS                    293K (tbc) Test harness        293K (tbc) SVM:                    mode H (tbd) IR rig:                 mode A, cold</p>	<p>1. <b>Sun Simulator:</b> off 2. <b>Shrouds:</b> <u>C1 shroud:</u> LN2 <u>C2 shroud:</u> LN2 3. <b>Pressure:</b> &lt;10<sup>-5</sup> mbar 4. <b>Spin Box:</b> <u>Temperature:</u> 293 K <u>SB shroud:</u> LN2 <u>Tilt angle:</u> -20° 5. <b>5m door and Cover:</b> closed</p>	
TP-G-2 during phase	<p>1. Monitor temperatures and test heater settings 2. Monitor HTT temperature and mass flow rate; manually adjust mass flow rate if HTT temperature drift exceeds ±3 mK/day throughout phase. 3. Monitor PLM external equilibrium temperature sensors throughout phase.</p>	<p>4. Start new CCS session 5. Monitor HK data. Inform shift leader and instruments teams of any red out-of-limit values throughout phase.</p>			
TS#10a	<p>6. Request CCS to perform <b>SPIRE TV</b> sequence</p>	<p>7. Perform <b>SPIRE TV sequence</b> acc. to section 8.10.1 of [AD2]. Request go-ahead from SVM TCS before performing cooler recycling.</p>			
TS#10b	<p>8. <b>In parallel</b> to SPIRE TV test: start transition to <b>SVM hot case</b> and stabilization in DTCP mode 9. Request TDH to set SVM test heaters acc. to [AD25] 11. Request CCS to start SVM TB DTCP phase. No cryo cooler recycling shall be performed during the TB DTCP phase. 12. Request TDH to load SVM alarm limits T6</p>	<p>13. On TCS request: Start SVM TB for STR1 and STR2 together: Perform section 8.10.2 of [AD2]. Note: Request go-ahead from shift leader / SVM TCS before cooler recycling!</p>	<p>10. Set SVM test heaters acc. to SVM TCS request 14. Load alarm limits as defined in <b>Annex A:</b> General LOU SVM: T6</p>		
Test location: ETS / LSS		Shift leader:	PA / QA:	Date:	



Step	Phase:	TP-G – SPIRE TV and SVM TB Hot		Remarks / NCR
	TCS, CVSE, Cryo	CCS: Instruments, PLM, SVM	FACILITY DATA HANDLING   LSS CONTROL	
TS#10c	15. Monitor SVM temperatures, <b>wait for stabilization</b>  ok at ...../.....	19. On TCS request: Start SVM TB hot DTCP mode: Perform section 8.10.3 of [AD2]. Note: Request go-ahead from shift leader / SVM TCS before cooler recycling!	17. Set SVM test heaters acc. to SVM TCS request	
	16. Request TDH to set SVM test heaters acc. to [AD25]			
TS#10d	18. Request CCS to start SVM TB for STR1 and STR2 together. No cryo cooler recycling shall be performed during the TB phase.	22. Switch SPIRE to stand-by mode acc. to section 8.10.4 of [AD2]. (if not included in previous script)	23. Load alarm limits as defined in <b>Annex A</b> : General LOU SVM: T4	
	20. Monitor SVM temperatures, <b>wait for stabilization</b>  ok at ...../.....			
	21. Request TDH to load SVM alarm limits T4			
	24. Request TDH to set SVM test heaters acc. to [AD25]			
TP-G-3 end of phase	1. Verify that end-of-phase conditions are reached:  3. Fill in: Date / Time of end: ..... / .....  4. Convene Key Point Meeting	2. Prepare EOP reports as defined in <b>Annex D</b>  5. Store CCS data (tables and rec files) on CD ROM		

Test location: ETS / LSS	Shift leader:	PA / QA:	Date:
-----------------------------	---------------	----------	-------

**I.8 TP-H – HIFI TV Test 3**

<b>Phase</b>	<b>TP-H – HIFI TV Test 3</b>	<b>Type:</b> stable	<b>S/C Attitude</b>	<b>Tilt /° : -20</b>
<b>Expected Duration / hrs</b>	53 (47 acc. to HIFI)	<b>TTAS I/F</b> 20°C	+Z to collimator mirror	
<b>Objective</b>	<ul style="list-style-type: none"> <li>• Performance test 5 frequencies per subband</li> <li>• Standing wave test</li> <li>• Tsys survey</li> <li>• Spur survey with diplexer scans (embedded in Tsys) (needs stable LOU temperature)</li> <li>• LO purity M1,2 sweep 3b, 7b</li> <li>• IF stability</li> </ul>			
<b>End of Phase Condition</b>	<ul style="list-style-type: none"> <li>• HIFI TV phase 3 tests completed</li> </ul>			
<b>Important</b>	<p>At the end of the HIFI test sequence, the IR rig heaters are switched to HOT mode (if PLM external stability criterion is met)</p> <p>TP-H covers the test spec phase TS #11.</p>			

Test location: ETS / LSS	Shift leader:	PA / QA:	Date:
-----------------------------	---------------	----------	-------

Step	Phase:	TP-H – HIFI TV Test 3		Remarks / NCR	
	TCS, CVSE, Cryo	CCS: Instruments, PLM, SVM	FACILITY DATA HANDLING      LSS CONTROL		
TP-H-1 start of phase	<p>1. <b>Cryo Valve States:</b> (unchanged) Open: V104, V501, V503, V504, V505, TVQM3 Closed: V103, V106, V102, V105, V701, V702</p>	<p>1. <b>Main Title:</b> Herschel FM TB/TV Test 2. <b>Subtitle:</b> TP-H – HIFI TV Test 3 3. Start new section in Log Book 4. Fill in: Date / Time of start: ..... / ..... 5. <b>CCS data logging:</b> Keep script "K102999ECVT035_ASDGEN_SCOE_CCU_LOG.tcl" running from previous phase; acquisition interval 30 sec.</p>	<p>1. <b>Main Title:</b> Herschel FM TB/TV Test 2. <b>Subtitle:</b> TP-H – HIFI TV Test 3 3. <b>Alarm Limits:</b> Keep alarm limits as defined in Annex A 4. <b>Acquisition Interval:</b> 2 min 5. <b>TDH Test Heaters:</b> unchanged TTAS                    293K (tbc) Test harness        293K (tbc) SVM:                    unchanged IR rig:                   mode A, cold</p>	<p>1. <b>Sun Simulator:</b> off 2. <b>Shrouds:</b> <u>C1 shroud:</u> LN2 <u>C2 shroud:</u> LN2 3. <b>Pressure:</b> &lt;10<sup>-5</sup> mbar 4. <b>Spin Box:</b> <u>Temperature:</u> 293 K <u>SB shroud:</u> LN2 <u>Tilt angle:</u> -20° 5. <b>5m door and Cover:</b> closed</p>	
TP-H-2 during phase	<p>1. Monitor temperatures and test heater settings 2. Monitor HTT temperature and mass flow rate; manually adjust mass flow rate if HTT temperature drift exceeds ±3 mK/day throughout phase. 3. Monitor PLM external equilibrium temperature sensors throughout phase.</p>	<p>4. Start new CCS session 5. Monitor HK data. Inform shift leader and instruments teams of any red out-of-limit values throughout phase.</p>			
TS#11a	<p>7. Request CCS to perform <b>HIFI test 3</b> sequence</p>	<p>6. HIFI team: implement updated look-up table for diplexer, IF2 drain currents, LOU VD2 (tbc by HIFI) 8. Perform <b>HIFI test 3sequence</b> acc. to section 8.11 of [AD2].</p>			
TS#11b	<p>10. When PLM external equilibrium conditions (CVV drift &lt; 0.3 K / 24 hrs) are reached, • Ensure that HACS measurements are performed for end of PLM-Ext-Cold phase</p>	<p>9. Switch HIFI to stand-by mode acc. to section 8.11 of [AD2]. (already included in previous script??)</p>			

Test location:	ETS / LSS	Shift leader:	PA / QA:	Date:
----------------	-----------	---------------	----------	-------

Step	Phase:	TP-H – HIFI TV Test 3		Remarks / NCR
	TCS, CVSE, Cryo	CCS: Instruments, PLM, SVM	FACILITY DATA HANDLING   LSS CONTROL	
	<ul style="list-style-type: none"> <li>Request go-ahead from Test Director to switch to PLM-EXT-HOT mode (IR rig heaters to mode B):  go-ahead at date / time: ..... / .....</li> <li>Signature: .....</li> </ul> <p>11. Request TDH to switch IR Rig test heaters to mode B (Note: This switching shall not be performed immediately before or during HIFI tests due to possible conflict with LOU stability req!!!)</p>		<p>12. On TCS request: Switch IR Rig test heaters to mode B</p>	
TP-H-3 end of phase	<p>1. Verify that end-of-phase conditions are reached:</p> <p>3. Fill in: Date / Time of end: ..... / .....</p> <p>4. Convene Key Point Meeting</p>	<p>2. Prepare EOP reports as defined in <b>Annex D</b></p> <p>5. Store CCS data (tables and rec files) on CD ROM</p>		

Test location: ETS / LSS	Shift leader:	PA / QA:	Date:
-----------------------------	---------------	----------	-------

**I.9 TP-I – PACS TV Test**

<b>Phase</b>	<b>TP-I – PACS TV Test</b>	<b>Type:</b> stable	<b>S/C Attitude</b>	<b>Tilt /° :</b> -20
<b>Expected Duration / hrs</b>	40	<b>TTAS I/F</b> 20°C	+Z to collimator mirror	
<b>Objective</b>	<ul style="list-style-type: none"> <li>• PACS instrument functional / performance tests</li> </ul>			
<b>End of Phase Condition</b>	<ul style="list-style-type: none"> <li>• PACS tests completed</li> </ul>			
<b>Important</b>	<p>The PACS TV test sequence consists of the following major elements:</p> <ul style="list-style-type: none"> <li>• PACS FDIR Verification</li> <li>• Chopper Controller Parameter Verification and Determination</li> <li>• Grating Controller Parameter Verification and Determination</li> <li>• Full Functional Test</li> <li>• PACS Reference Mission Scenario</li> <li>• Short Performance Test</li> <li>• Red Bolometer Tuning</li> <li>• AOT Test</li> <li>• Test of Redundant PACS Instrument</li> </ul> <p>TP-I covers the test spec phase TS #12.</p>			

Test location: <b>ETS / LSS</b>	Shift leader:	PA / QA:	Date:
------------------------------------	---------------	----------	-------

Step	Phase:	TP-I – PACS TV Test		Remarks / NCR	
	TCS, CVSE, Cryo	CCS: Instruments, PLM, SVM	FACILITY DATA HANDLING      LSS CONTROL		
TP-I-1 start of phase	<p>1. <b>Cryo Valve States:</b> (unchanged) Open: V104, V501, V503, V504, V505, TVQM3 Closed: V103, V106, V102, V105, V701, V702</p>	<p>1. <b>Main Title:</b> Herschel FM TB/TV Test 2. <b>Subtitle:</b> TP-I – PACS TV Test 3. Start new section in Log Book 4. Fill in: Date / Time of start: ..... / .....</p> <p>5. <b>CCS data logging:</b> Keep script "K102999ECVT035_ASDGEN_SCOE_CCU_LOG.tcl" running from previous phase; acquisition interval 30 sec.</p>	<p>1. <b>Main Title:</b> Herschel FM TB/TV Test 2. <b>Subtitle:</b> TP-I – PACS TV Test 3. <b>Alarm Limits:</b> Keep alarm limits as defined in <b>Annex A</b> 4. <b>Acquisition Interval:</b> 2 min 5. <b>TDH Test Heaters:</b> unchanged TTAS                    293K (tbc) Test harness        293K (tbc) SVM:                    unchanged IR rig:                   mode B, hot</p>	<p>1. <b>Sun Simulator:</b> off 2. <b>Shrouds:</b> <u>C1 shroud:</u> LN2 <u>C2 shroud:</u> LN2 3. <b>Pressure:</b> &lt;10<sup>-5</sup> mbar 4. <b>Spin Box:</b> <u>Temperature:</u> 293 K <u>SB shroud:</u> LN2 <u>Tilt angle:</u> -20° 5. <b>5m door and Cover:</b> closed</p>	
TP-I-2 during phase	<p>1. Monitor temperatures and test heater settings 2. Monitor HTT temperature and mass flow rate; manually adjust mass flow rate if HTT temperature drift exceeds ±3 mK/day throughout phase. 3. Monitor PLM external equilibrium temperature sensors throughout phase.</p>	<p>4. Start new CCS session 5. Monitor HK data. Inform shift leader and instruments teams of any red out-of-limit values throughout phase.</p>			
TS#12a	<p>6. Request CCS to perform <b>PACS TV test</b> sequence</p>	<p>7. Perform <b>PACS TV sequence</b> acc. to section 8.12 of [AD2].</p>			
TS#12b		<p>8. Switch PACS to stand-by mode acc. to section 8.12 of [AD2].</p>			
TP-I-3 end of phase	<p>1. Verify that end-of-phase conditions are reached: 3. Fill in:</p>	<p>2. Prepare EOP reports as defined in <b>Annex D</b> 5. Store CCS data (tables and rec files) on CD ROM</p>			

Test location:	ETS / LSS	Shift leader:	PA / QA:	Date:
----------------	-----------	---------------	----------	-------

Step	Phase:	TP-I – PACS TV Test	FACILITY		Remarks / NCR
	TCS, CVSE, Cryo	CCS: Instruments, PLM, SVM	DATA HANDLING	LSS CONTROL	
	Date / Time of end: ..... / .....				
4.	Convene Key Point Meeting				

Test location:	ETS / LSS	Shift leader:	PA / QA:	Date:
----------------	-----------	---------------	----------	-------

I.10 TP-J – HIFI TV Test 4

<b>Phase</b>	<b>TP-J – HIFI TV Test 4</b>	<b>Type:</b> stable	<b>S/C Attitude</b>	<b>Tilt /° : -20</b>
<b>Expected Duration / hrs</b>	78 (88 acc. to HIFI)	<b>TTAS I/F</b> 20°C	+Z to collimator mirror	
<b>Objective</b>	<ul style="list-style-type: none"> <li>Stability verification</li> <li>LCU ripple test: Take 10ms mixer currents (embedded ini stability)</li> <li>AOT test</li> </ul>			
<b>End of Phase Condition</b>	<ul style="list-style-type: none"> <li>HIFI TV phase 4 tests completed</li> </ul>			
<b>Important</b>	TP-J covers the test spec phase TS #13.			

Test location: ETS / LSS	Shift leader:	PA / QA:	Date:
-----------------------------	---------------	----------	-------



Step	Phase:	TP-J – HIFI TV Test 4		Remarks / NCR	
	TCS, CVSE, Cryo	CCS: Instruments, PLM, SVM	FACILITY DATA HANDLING      LSS CONTROL		
TP-J-1 start of phase	<ol style="list-style-type: none"> <li><b>Cryo Valve States:</b> (unchanged) Open: V104, V501, V503, V504, V505, TVQM3 Closed: V103, V106, V102, V105, V701, V702</li> </ol>	<ol style="list-style-type: none"> <li><b>Main Title:</b> Herschel FM TB/TV Test</li> <li><b>Subtitle:</b> TP-J – HIFI TV Test 4</li> <li>Start new section in Log Book</li> <li>Fill in: Date / Time of start: ..... / .....</li> <li><b>CCS data logging:</b> Keep script "K102999ECVT035_ASDGEN_SCOE_CCU_LOG.tcl" running from previous phase; acquisition interval 30 sec.</li> </ol>	<ol style="list-style-type: none"> <li><b>Main Title:</b> Herschel FM TB/TV Test</li> <li><b>Subtitle:</b> TP-J – HIFI TV Test 4</li> <li><b>Alarm Limits:</b> Keep alarm limits as defined in <b>Annex A</b></li> <li><b>Acquisition Interval:</b> 2 min</li> <li><b>TDH Test Heaters:</b> unchanged TTAS                    293K (tbc) Test harness        293K (tbc) SVM:                    unchanged IR rig:                    mode B, hot</li> </ol>	<ol style="list-style-type: none"> <li><b>Sun Simulator:</b> off</li> <li><b>Shrouds:</b> <u>C1 shroud:</u> LN2 <u>C2 shroud:</u> LN2</li> <li><b>Pressure:</b> &lt;10<sup>-5</sup> mbar</li> <li><b>Spin Box:</b> <u>Temperature:</u> 293 K <u>SB shroud:</u> LN2 <u>Tilt angle:</u> -20°</li> <li><b>5m door and Cover:</b> closed</li> </ol>	
TP-J-2 during phase	<ol style="list-style-type: none"> <li>Monitor temperatures and test heater settings</li> <li>Monitor HTT temperature and mass flow rate; manually adjust mass flow rate if HTT temperature drift exceeds ±3 mK/day throughout phase.</li> <li>Monitor PLM external equilibrium temperature sensors throughout phase.</li> </ol>	<ol style="list-style-type: none"> <li>Start new CCS session</li> <li>Monitor HK data. Inform shift leader and instruments teams of any red out-of-limit values throughout phase.</li> </ol>			
TS#13a	<ol style="list-style-type: none"> <li>Request CCS to perform <b>HIFI test 4</b> sequence</li> </ol>	<ol style="list-style-type: none"> <li>HIFI team: implement updated frequency switch values from the standing wave tests (tbc by HIFI)</li> <li>Perform <b>HIFI test 4 sequence</b> acc. to section 8.13 of [AD2].</li> </ol>			
TS#13b		<ol style="list-style-type: none"> <li>Switch HIFI to stand-by mode acc. to section 8.13 of [AD2]. (if not included in previous script)</li> </ol>			
TP-J-3 end of phase	<ol style="list-style-type: none"> <li>Verify that end-of-phase conditions are reached:</li> <li>Fill in:</li> </ol>	<ol style="list-style-type: none"> <li>Prepare EOP reports as defined in <b>Annex D</b></li> <li>Store CCS data (tables and rec files) on CD ROM</li> </ol>			
Test location: ETS / LSS		Shift leader:	PA / QA:	Date:	

Step	Phase:	TP-J – HIFI TV Test 4	FACILITY		Remarks / NCR
	TCS, CVSE, Cryo	CCS: Instruments, PLM, SVM	DATA HANDLING	LSS CONTROL	
	Date / Time of end: ..... / .....				
4.	Convene Key Point Meeting				

Test location:	ETS / LSS	Shift leader:	PA / QA:	Date:
----------------	-----------	---------------	----------	-------

I.11 TP-K – SVM TV HOT

<b>Phase</b>	<b>TP-K – SVM TV HOT</b>	<b>Type:</b> stable	<b>S/C Attitude</b>	<b>Tilt /° : -20</b>
<b>Expected Duration / hrs</b>	64 +120 SOVT2	<b>TTAS I/F</b> 20°C	+Z to collimator mirror	
<b>Objective</b>	<ul style="list-style-type: none"> <li>• Perform Videogrammetry measurement</li> <li>• Perform DLCM and LLP measurement</li> <li>• Perform SVM unit functional tests</li> <li>• Perform SFT on instruments</li> <li>• Perform CCU testing</li> <li>• Perform helium vent line dp measurements with big and small nozzles and PPS operation</li> <li>• Warm up telescope using decontamination heaters, and verify cycling</li> <li>• Warm up LOU baffle and verify decontamination heaters</li> <li>• Perform RCS global leak test</li> </ul>			
<b>End of Phase Condition</b>	<ul style="list-style-type: none"> <li>• Telescope heaters cycling</li> <li>• LOU baffle heaters cycling</li> <li>• SVM functional tests completed</li> </ul>			
<b>Important</b>	<p>At the end of the telescope heater verification, the telescope decontamination heaters will be kept ON (at the end of the telescope decontamination verification) during the recovery to ambient.</p> <p>TP-K covers the test spec phase TS #13c and TS #14.</p>			

Test location: ETS / LSS	Shift leader:	PA / QA:	Date:
-----------------------------	---------------	----------	-------

Step	Phase:	TP-K – SVM TV HOT		Remarks / NCR	
	TCS, CVSE, Cryo	CCS: Instruments, PLM, SVM	FACILITY DATA HANDLING      LSS CONTROL		
TP-K-1 start of phase	<p>1. <b>Cryo Valve States:</b> (unchanged) Open: V104, V501, V503, V504, V505, TVQM3 Closed: V103, V106, V102, V105, V701, V702</p>	<p>1. <b>Main Title:</b> Herschel FM TB/TV Test 2. <b>Subtitle:</b> TP-K – SVM TV HOT 3. Start new section in Log Book 4. Fill in: Date / Time of start: ..... / ..... 5. <b>CCS data logging:</b> Keep script "K102999ECVT035_ASDGEN_SCOE_CCU_LOG.tcl" running from previous phase; acquisition interval 30 sec.</p>	<p>1. <b>Main Title:</b> Herschel FM TB/TV Test 2. <b>Subtitle:</b> TP-K – SVM TV HOT 3. <b>Alarm Limits:</b> Keep alarm limits as defined in <b>Annex A</b> 4. <b>Acquisition Interval:</b> 2 min 5. <b>TDH Test Heaters:</b> unchanged TTAS                    293K (tbc) Test harness        293K (tbc) SVM:                    unchanged IR rig:                   mode B, hot</p>	<p>1. <b>Sun Simulator:</b> off 2. <b>Shrouds:</b> <u>C1 shroud:</u> LN2 <u>C2 shroud:</u> LN2 3. <b>Pressure:</b> &lt;10<sup>-5</sup> mbar 4. <b>Spin Box:</b> <u>Temperature:</u> 293 K <u>SB shroud:</u> LN2 <u>Tilt angle:</u> -20° 5. <b>5m door and Cover:</b> closed</p>	
TP-K-2 during phase	<p>1. Monitor temperatures and test heater settings 2. Monitor HTT temperature and mass flow rate; manually adjust mass flow rate if HTT temperature drift exceeds ±3 mK/day throughout phase. 3. Monitor PLM external equilibrium temperature sensors throughout phase to detect end of PLM external hot stabilization (CVV drift &lt; 0.3 K / 24 hrs).  Equilibrium at date / time: ..... / ..... 6. Request CCS to disable Gyro / STR continuity check for tilting 8. Request LSS to return S/C to vertical orientation  vertical at ..... / ..... 10. Request CCS to enable Gyro / STR continuity check 30 min after end of tilting:</p>	<p>4. Start new CCS session 5. Monitor HK data. Inform shift leader and instruments teams of any red out-of-limit values throughout phase.  7. On request of shift leader: disable Gyro / STR continuity check acc to section section 9.3 of [AD2].  11. On request of shift leader: enable Gyro / STR continuity check acc to section section 9.3 of [AD2].</p>		<p>9. On TCS request: return to vertical position (0° tilt) Tilt speed: 1°/min</p>	
TS#13c	<p>12. Request TDH to perform <b>videogrammetry measurement</b></p>		<p>13. On TCS request: perform videogrammetry measurement</p>		
Test location: ETS / LSS		Shift leader:	PA / QA:	Date:	

Step	Phase:	TP-K – SVM TV HOT	FACILITY		Remarks / NCR
	TCS, CVSE, Cryo	CCS: Instruments, PLM, SVM	DATA HANDLING	LSS CONTROL	
TS#14a	14. Request CCS to measure HTT contents using L101/L102  HTT filling level: ..... %  15. Determine required tilt angle for PPS operation from section H.1.1.  Required tilt angle: .....  17. Request CCS to perform DLCM measurement  19. Request TDH to set SVM test heaters acc. to [AD25]	16. On TCS request: Perform LLP measurement acc to section 9.4.1 of [AD2]    18. On TCS request: Perform DLCM measurement acc to section 8.14.1 of [AD2]		20. Set SVM test heaters acc. to SVM TCS request	
TS#14b	21. In parallel to SVM TV hot and decontamination heater verification: <b>Perform He pressure drop tests</b> (including sensors cross-check) as defined below up to step TP-K-B-72.  22. Record gas meter reading:  Gas meter: .....m <sup>3</sup>  23. Disconnect gas meter (to reduce mass flow oscillations)  ok at date / time: ..... / .....  24. Close valve TVQM3. New cryo valve states: Open: V104, V501, V503, V504, V505 Closed: V103, V106, V102, V105, V701, V702, TVQM3  ok at ..... / .....  26. Fully open He pump inlet ball valves Y0631, close needle valves to measure with high mass flow ( <b>PPS bypass</b> )  27. Measure flow through small and large nozzles (PPS bypass): Wait for stable readings on all pressure sensors P502, P501, CVSE_002, CVSE_003, CVSE_005  28. Record P506 analogue pressure reading:  P506: .....mbar  Date / time: ..... / .....	25. On TCS request: Close valve TVQM3 (SPARE1 on CryoSCOE)			
Test location: ETS / LSS		Shift leader:	PA / QA:		Date:

Step	Phase:	TP-K – SVM TV HOT	FACILITY		Remarks / NCR
	TCS, CVSE, Cryo	CCS: Instruments, PLM, SVM	DATA HANDLING	LSS CONTROL	
29.	Close valve V505 to measure small nozzles. New cryo valve states: Open: V104, V501, V503, V504 Closed: V102, V103, V106, V105, V701, V702, V505, TVQM3  ok at ..... / .....	32. On TCS request: Close valve V505			
30.	Wait for stable readings on all pressure sensors P502, P501, CVSE_002, CVSE_003, CVSE_005				
31.	Record P506 analogue pressure reading:  P506: .....mbar  Date / time: ..... / .....				
33.	Open PPS valve V103 and close HTT outlet V104 to measure small nozzles with low mass flow ( <b>gas pumping through PPS</b> ). New cryo valve states: Open: V103, V501, V503, V504 Closed: V104, V102, V106, V105, V701, V702, V505, TVQM3  ok at ..... / ..... Note: very small mass flow is expected when pumping gas through PPS.	36. On TCS request: Open valve V103, close valve V104			
34.	Wait for stable readings on all pressure sensors, P502, P501, CVSE_002, CVSE_003, CVSE_005				
35.	Record P506 analogue pressure reading:  P506: .....mbar  Date / time: ..... / .....				
37.	Open V505 to measure small and large nozzles with low mass flow (gas pumping through PPS). New cryo valve states: Open: V103, V501, V503, V504, V505 Closed: V104, V102, V106, V105, V701, V702, TVQM3  ok at ..... / .....	40. On TCS request: Open valve V505			
38.	Wait for stable readings on all pressure sensors, P502,				
Test location: ETS / LSS		Shift leader:	PA / QA:	Date:	

Step	Phase:	TP-K – SVM TV HOT	FACILITY		Remarks / NCR
	TCS, CVSE, Cryo	CCS: Instruments, PLM, SVM	DATA HANDLING	LSS CONTROL	
	<p>P501, CVSE_002, CVSE_003, CVSE_005</p> <p>39. Record P506 analogue pressure reading:</p> <p>P506: .....mbar</p> <p>Date / time: ..... / .....</p> <p>41. Skip pressure drop measurements with PPS operating (i.e. go to step TPK-2-T53) if required tilt angle is above maximum allowed angle (PPS operation not possible)</p> <p>42. Before S/C tilting: request CCS to disable the GYR/STR continuity check</p> <p>44. Pressure drop <b>measurements with PPS operating:</b> Request LSS to tilt to required tilt angle</p> <p>46. Verify PPS operation: T111 &lt; T101</p> <p>47. Measure small and large nozzles with nominal mass flow (PPS operating): Wait for stable readings on all pressure sensors, P502, P501, CVSE_002, CVSE_003, CVSE_005</p> <p>48. Record P506 analogue pressure reading:</p> <p>P506: .....mbar</p> <p>Date / time: ..... / .....</p> <p>49. Close V505 to measure small nozzles with nominal mass flow (PPS operating). New cryo valve states: Open: V103, V501, V503, V504 Closed: V104, V102, V106, V105, V701, V702, V505, TVQM3</p> <p>ok at ..... / .....</p> <p>50. Wait for stable readings on all pressure sensors, P502, P501, CVSE_002, CVSE_003, CVSE_005</p> <p>51. Record P506 analogue pressure reading:</p> <p>P506: .....mbar</p>	<p>43. On request of shift leader: disable the GYR/STR continuity check acc to section section 9.3 of [AD2]</p> <p>52. On TCS request: close valve V505</p>		<p>45. On TCS request: Adjust tilt angle, rotation around S/C Z axis, S/C X towards S/C -Y. Tilt direction: + Tilt speed: 1°/min</p>	
Test location: ETS / LSS		Shift leader:	PA / QA:		Date:





Step	Phase:	TP-K – SVM TV HOT	FACILITY		Remarks / NCR
	TCS, CVSE, Cryo	CCS: Instruments, PLM, SVM	DATA HANDLING	LSS CONTROL	
	Date / time: ..... / .....				
	66. Open large nozzle valve V505 and nozzle bypass TVQM3. New cryo valve states: Open: V104, V501, V503, V504, V505, TVQM3 Closed: V102, V103, V106, V105, V701, V702  ok at ..... / .....	69. On TCS request: open valve V505 and valve TVQM3 (SPARE1 on CryoSCOE)			
	67. Open both manual He pump inlet valves Y0631 to re-start pumping via HTT outlet and small nozzles. Adjust mass flow to 4.0±0.5 mg/s				
	68. Reconnect Gas meter  ok at ..... / .....				
	70. 30 min after last S/C tilting (step 57 above): request CCS to enable the GYR/STR continuity check	71. On request of shift leader: enable the GYR/STR continuity check acc to section section 9.3 of [AD2]			
	72. <b>End of pressure drop measurements sequence</b> (independent from SVM TV hot sequence)				
	73. Verify that warmest SVM equipment sensor is at hot predicted level including margins (-0/+5°C, tbc)  coldest equipment sensor: .....  Temperature: .....  ok at ...../.....				
	74. In parallel to SVM TV hot and pressure drop measurements: Perform <b>LOU decontamination verification sequence</b> as defined below up to step TP-K-B-90.				
TS#14c	75. Verify / set maximum temperature thresholds for LOU heater lines 1, 2 and 3 to Tmin=220 K, Tmax=230 K.	76. Perform section 8.14.3 of [AD2] to verify / set maximum temperature thresholds for LOU heater lines 1, 2 and 3 Tmin=220 K, Tmax=230 K.			
TS#14d	77. Switch on LOU decontamination heater lines 1 and 2	79. Perform section 8.14.4 of [AD2] to switch ON LOU decontamination heater lines 1 and 2			
Test location: ETS / LSS		Shift leader:	PA / QA:	Date:	

Step	Phase:	TP-K – SVM TV HOT		Remarks / NCR
	TCS, CVSE, Cryo	CCS: Instruments, PLM, SVM	FACILITY DATA HANDLING   LSS CONTROL	
TS#14e	78. Wait for LOU heater line cycling (2 times OFF/ON) ok at ...../..... 80. Switch OFF LOU decontamination heater lines 1 and 2 81. Wait for 2 hours	82. Perform section 8.14.5 of [AD2] to switch OFF LOU decontamination heater lines 1 and 2		
TS#14f	83. Select LOU heater lines 1 + 3	84. Perform section 8.14.6 of [AD2] to select LOU heater lines 1 + 3		
TS#14g	85. Switch on LOU decontamination heater lines 1 and 3 86. Wait for LOU heater lines cycling (2 times OFF/ON) ok at ...../.....	87. Perform section 8.14.7 of [AD2] to switch ON LOU decontamination heater lines 1 and 3		
TS#14h	88. Switch OFF LOU decontamination heater lines 1 and 3  <b>90. End of LOU decontamination verification sequence</b>	89. Perform section 8.14.8 of [AD2] to switch OFF LOU decontamination heater lines 1 and 3		
TS#14i	91. In parallel to LOU heater verification and pressure drop measurements: Request CCS to perform <b>SVM TV Hot</b> sequence (including loading of SVM TCT 6). Initiate Telescope decontamination sequence (step TP-K-B-122) 24hrs before expected end of SVM TV hot	93. Perform <b>SVM TV Hot</b> , TT&C CELL-B acc. to sections 8.14.9 to 8.14.10 of [AD2].	94. Load alarm limits as defined in <b>Annex A</b> : General LOU SVM: T6	
TS#14j	92. Request TDH to load SVM alarm limits T6 95. Request TDH to load SVM alarm limits T5	96. Load TCT table "TCT 7 TV_HOT 14j-14m" 97. Perform TT&C Cell/A acc. to section 8.14.11 of [AD2]	98. Load alarm limits as defined in <b>Annex A</b> : General LOU SVM: T5	
TS#14k		99. Perform TV Hot, Power Cell /B acc. to section 8.14.12 of [AD2]		
TS#14l		100. Perform TV Hot, Power Cell /A acc. to section 8.14.12 of [AD2]		
Test location: ETS / LSS		Shift leader:	PA / QA:	Date:

Step	Phase:	TP-K – SVM TV HOT	FACILITY		Remarks / NCR
	TCS, CVSE, Cryo	CCS: Instruments, PLM, SVM	DATA HANDLING	LSS CONTROL	
TS#14m		[AD2] 101. Perform TV Hot, RW cell + STR 2 acc. to section 8.14.13 of [AD2]			
TS#14n		102. Load TCT table "TCT 8 TV_HOT 14n" 103. Perform TV Hot, RW cell + STR 1 acc. to section 8.14.13 of [AD2]			
	104. Ensure that S/C is vertical before starting HIFI SFTs.  ok at ...../.....				
	105. Request TDH to load SVM alarm limits T4			106. Load alarm limits as defined in <b>Annex A:</b> General LOU SVM: T4	
TS#14p	107. Request TDH to set SVM test heaters acc. to [AD25]	108. Perform TV Hot, HIFI Cell /A acc. to section 8.14.15 of [AD2]		109. Set SVM test heaters acc. to SVM TCS request	
	110. Request CCS to load SVM TCS TCT table 9 (TS#14o-14w)	111. On TCS request: Load SVM TCS TCT table 9 (TS#14o-14w)			
TS#14q		112. Perform TV Hot, HIFI Cell /B acc. to section 8.14.16 of [AD2]			
TS#14r		113. Perform TV Hot, PACS Cell /A acc. to section 8.14.17 of [AD2]			
TS#14s		114. Perform TV Hot, PACS Cell /B acc. to section 8.14.18 of [AD2]			
TS#14t		115. Perform TV Hot, SPIRE Cell /A acc. to section 8.14.19 of [AD2]			
TS#14u		116. Perform TV Hot, SPIRE Cell /B acc. to section 8.14.20 of [AD2]			
TS#14v	117. Request CCS to switch off instruments	118. Perform instruments switch-off acc. to section 8.14.21 of [AD2]			
	<b>119. End of SVM TV hot sequence</b>				

Test location:	ETS / LSS	Shift leader:	PA / QA:	Date:
----------------	-----------	---------------	----------	-------

Step	Phase:	TP-K – SVM TV HOT	FACILITY		Remarks / NCR
	TCS, CVSE, Cryo	CCS: Instruments, PLM, SVM	DATA HANDLING	LSS CONTROL	
TS#14w	<b>120. TT&amp;C test sequence</b>	121. Perform TT&C test sequence acc. to section 8.14.22 of [AD2] (Expected duration 16 hrs)			
TS#14o	<p>122. During SVM TV hot sequence, 24 hrs before expected end of SVM TV hot: <b>Start Telescope decontamination heater verification</b> (expected duration ~20 hrs)</p> <p>124. Wait for cycling of at least 3 telescope decontamination heater lines</p> <p>ok at ...../.....</p> <p>125. Remove Telescope decontamination heater line mask to enable lines 5 and 9 in addition</p> <p>126. Wait for stability of average telescope temperature: slope &lt; 3°C/day for two consecutive minima (heater switch on) and two consecutive maxima (heater switch off)</p> <p>ok at ...../.....</p> <p>127. End of <b>Telescope decontamination</b> sequence (Note: Telescope decontamination is kept ON for Warm-up)</p> <p>129. Request TAS-F to initiate <b>Global Leak measurements</b> acc. to [AD30]; continue with next steps</p>	<p>123. Perform section 8.14.14 of [AD2] to start telescope decontamination heater verification (including initial masking of heater lines 5 and 9): Thresholds are +43.5°C / +44.4°C</p> <p>128. (Note: Telescope decontamination is kept ON for Warm-up)</p>			
Test location: ETS / LSS		Shift leader:	PA / QA:		Date:

Step	Phase:	TP-K – SVM TV HOT	FACILITY		Remarks / NCR
	TCS, CVSE, Cryo	CCS: Instruments, PLM, SVM	DATA HANDLING	LSS CONTROL	
130. After end of SVM TV Hot sequence: <b>Initiate SOVT2 test sequence</b>					
131. Before S/C tilting: request CCS to disable the GYR/STR continuity check		132. On request of shift leader: disable the GYR/STR continuity check acc to section section 9.3 of [AD2]			
133. Request LSS to tilt S/C to -20° tilt angle for instrument cooler recycling  20° reached at ..... / .....				134. On TCS request: tilt S/C to -20°. Tilt speed: 1°/min	
135. 30 min after S/C tilting: request CCS to enable the GYR/STR continuity check		136. On request of shift leader: enable the GYR/STR continuity check acc to section section 9.3section 9.3 of [AD2]			
137. Give go-ahead to perform SOVT2 test acc. to [AD29].		<p><b>Open Issues to be clarified:</b></p> <ul style="list-style-type: none"> <li>SVM configuration at beginning of SOVT</li> <li>SVM test heater settings</li> <li>Responsibilities</li> </ul> <p>...</p>			
138. Wait for completion of SOVT2 test (expected duration 5d)					
139. Before S/C tilting: request CCS to disable the GYR/STR continuity check		140. On request of shift leader: disable the GYR/STR continuity check acc to section section 9.3 of [AD2]			
141. Request LSS to return to 0° tilt angle  vertical at ..... / .....				142. On TCS request: return to vertical position (0° tilt) Tilt speed: 1°/min	
143. 30 min after S/C tilting: request CCS to enable the GYR/STR continuity check		144. On request of shift leader: enable the GYR/STR continuity check acc to section section 9.3 of [AD2]			
<b>145. End of SOVT2 test sequence</b>					

Test location: ETS / LSS	Shift leader:	PA / QA:	Date:
--------------------------	---------------	----------	-------

Step	Phase:	TP-K – SVM TV HOT		Remarks / NCR
	TCS, CVSE, Cryo	CCS: Instruments, PLM, SVM	DATA HANDLING FACILITY LSS CONTROL	
TP-K-3 end of phase	1. Verify that end-of-phase conditions are reached:  3. Fill in: Date / Time of end: ..... / .....  4. Convene Key Point Meeting	2. Prepare EOP reports as defined in <b>Annex D</b>  5. Store CCS data (tables and rec files) on CD ROM		

Test location: ETS / LSS	Shift leader:	PA / QA:	Date:
-----------------------------	---------------	----------	-------

I.12 TP-L - Recovery to Ambient

<b>Phase</b>	<b>TP-L - Recovery to Ambient</b>	<b>Type:</b> Transient	<b>S/C Attitude</b>	<b>Tilt /° : 0</b>
<b>Expected Duration / hrs</b>	72	<b>TTAS I/F</b> 20°C	+Z to collimator mirror	
<b>Objective</b>	<ul style="list-style-type: none"> <li>• Warm-up of S/C external surfaces to ambient temperature</li> <li>• Warm-up of LSS shrouds</li> <li>• Re-pressurization of LSS</li> </ul>			
<b>End of Phase Condition</b>	<ul style="list-style-type: none"> <li>• LSS ready to open chamber</li> </ul>			
<b>Important</b>	<p>Warm-up of the S/C is initiated by electrical test heaters. The LSS shroud temperatures are to be kept 10°C colder than the external S/C parts to avoid contamination.</p> <p>The S/C will be switched off during the warm up (when the maximum temperatures allowed on the power panel units is reached, PCDU likely to trigger first). The S/C will be switched ON later, once repressurisation is made.</p> <p>The Telescope decontamination heaters are kept ON for warm-up.</p> <p>During the repressurization, special care has to be taken to check for indication of a possible air leak into the CVV. Indications are sudden temperature rise of the CVV internal components (Thermal Shields, Optical Bench, HTT, Mass flow). Emergency procedure is to re-evacuate the LSS in case of leak indication.</p> <p>IST testing of the S/C is foreseen to be performed during the recovery phase after the go-ahead from TB/TV test director. These tests are performed under control of the IST test procedure.</p>			

Test location:	ETS / LSS	Shift leader:	PA / QA:	Date:
----------------	-----------	---------------	----------	-------

Step	Phase:	TP-L - Recovery to Ambient		Remarks / NCR	
	TCS, CVSE, Cryo	CCS: Instruments, PLM, SVM	FACILITY DATA HANDLING      LSS CONTROL		
TP-L-1 start of phase	<p>1. <b>Cryo Valve States:</b> (unchanged) Open: V104, V501, V503, V504, V505, TVQM3 Closed: V102, V103, V106, V105, V701, V702</p>	<p>1. <b>Main Title:</b> Herschel FM TB/TV Test 2. <b>Subtitle:</b> TP-L - Recovery to Ambient 3. Start new section in Log Book 4. Fill in: Date / Time of start: ..... / ..... 5. <b>CCS data logging:</b> Restart script "K102999ECVT035_ASDGEN_SCOE_CCU_LOG.tcl" acquisition interval 30 sec.</p>	<p>1. <b>Main Title:</b> Herschel FM TB/TV Test 2. <b>Subtitle:</b> TP-L - Recovery to Ambient 3. <b>Alarm Limits:</b> Load alarm limits as defined in <b>Annex A:</b> General LOU SVM: T2 4. <b>Acquisition Interval:</b> 2 min 5. <b>TDH Test Heaters:</b>  TTAS                    293K (tbc) Test harness        293K (tbc) SVM:                    unchanged IR rig:                mode B, hot</p>	<p>1. <b>Sun Simulator:</b> off 2. <b>Shrouds:</b> <u>C1 shroud:</u> LN2 <u>C2 shroud:</u> LN2 3. <b>Pressure:</b> &lt;10<sup>-5</sup> mbar 4. <b>Spin Box:</b> <u>Temperature:</u> 293 K <u>SB shroud:</u> LN2 <u>Tilt angle:</u> 0° 5. <b>5m door and Cover:</b> closed</p>	
TP-L-2 during phase  TS#15b	<p>1. Switch on PLM warm-up test heaters 2. Continuously perform HACS measurements during CVV warm-up. 3. Monitor temperatures and test heater settings 4. Monitor HTT temperature and mass flow rate 5. Monitor PLM external temperature sensors throughout phase to verify warm-up heaters operation 8. Gradually reduce SVM test heater power acc. to [AD25].  10. Give go-ahead to CCS to <b>start SFT2 testing under control of SFT2 test procedure and under responsibility of the SFT2 test team. Thermal and S/C responsibility remains with TB test team until opening of chamber.</b> Monitor SVM temperature throughout warm-up and switch off the SVM if upper acceptance warning limits are reached</p>	<p>6. Start new CCS session          11. On go-ahead of TCS: Start SFT2 testing under control of SFT2 test procedure. Be prepared to switch off SVM in case of temperature acceptance limits violation.</p>	<p>7. Switch on PLM warm-up test heaters (mode A, target temperature 293 K)         9. Set SVM test heaters acc. to SVM TCS request</p>		
Test location: ETS / LSS		Shift leader:	PA / QA:	Date:	



Step	Phase:	TP-L - Recovery to Ambient	FACILITY		Remarks / NCR
	TCS, CVSE, Cryo	CCS: Instruments, PLM, SVM	DATA HANDLING	LSS CONTROL	
12. Keep ~20 mbar pressure in LSS internal safety line					
13. When minimum external temperature (virtual sensors) is >120 K, request LSS to <b>initiate warm up of shrouds.</b>					
14. Monitor CVV test heater harness temperature. Reduce test heater power if necessary to keep harness temperature below 110°C (383 K)					
			15. Remove shroud temperature alarm limits	16. On request of test conductor: stop C1 LN2 mode and open V001 (keep C2 in LN2 mode). ..... / .....	
				17. Drain C1. ..... / .....	
				18. Set mirror temperature at 40°C. ..... / .....	
				19. Start C1 VTC mode to bring C1 shrouds at ambient temperature. ..... / .....	
				20. While S/C temperature below 20°C (tbc – was 0°C for STM2): Keep shrouds 10 K below minimum external S/C temperature (virt sensor)	
				21. When C1 shrouds are stabilised at ambient temperature, stop C1 VTC mode. ..... / .....	
				22. Prepare facility for C2 draining. ..... / .....	
				23. Stop LN2 pump and stop C2 LN2 mode. ..... / .....	
				24. Start C2 draining mode. ..... / .....	
				25. When draining is finished, open V084 and V 085 on	
Test location:	ETS / LSS	Shift leader:	PA / QA:	Date:	

Step	Phase:	TP-L - Recovery to Ambient	FACILITY		Remarks / NCR
	TCS, CVSE, Cryo	CCS: Instruments, PLM, SVM	DATA HANDLING	LSS CONTROL	
				the LN2 pump local cabinet. ..... / ..... 26. Start C2 warm-up mode, gas temperature set point 30°C. ..... / ..... 27. When C2 shrouds are at ambient temperature, stop C2 warm up. ..... / ..... 28. Start C1 and C2 warm-up to stabilized shrouds at ambient temperature. (Switch on W10) ..... / ..... 29. When C1 and C2 are stabilized at ambient temperature, inform customer that LSS is ready for re-pressurisation. ..... / .....	
	30. When <b>ambient temperature is reached</b> on structure and MLI average sensors: Check that manual SV121 pressurization valve is closed. Increase pressure in LSS internal safety line to 1050 mbar from pressurized He gas bottle  Ok at date / time: ..... / ..... 31. Switch off VG902  Switched off at date / time:..... / ..... 32. Switch off HACS  Switched off at date / time:..... / ..... 33. Request TDH to perform <b>Videogrammetry</b> measurement acc. to [AD23]			34. Perform Videogrammetry measurement acc. to [AD23]	

Test location:	ETS / LSS	Shift leader:	PA / QA:	Date:
----------------	-----------	---------------	----------	-------

Step	Phase:	TP-L - Recovery to Ambient	FACILITY		Remarks / NCR
	TCS, CVSE, Cryo	CCS: Instruments, PLM, SVM	DATA HANDLING	LSS CONTROL	
TS#16a	35. Check He background in LSS vacuum 36. If a significant He background is found: <ul style="list-style-type: none"> <li>• <b>Do not initiate LSS repressurization.</b></li> <li>• Inform test director / conductor</li> </ul> 38. Monitor HTT, OBA and TS1, TS2, TS3 temperatures and He mass flow rate during re-pressurisation to <b>detect possible indication of CVV air leak</b> . In case of sudden increase, request LSS to stop pressurization and start re-pumping the LSS vacuum immediately.	42.	43. Remove pressure and cryo panel temperature alarm limits	37. Check He background in LSS vacuum  39. Be prepared to immediately stop chamber re-pressurisation and re-start pumping immediately on TCS request.	
	40. Request LSS to <b>initiate repressurisation</b> up to 80 mbar 41. Switch on H501 to control external vent line temperature to 293 K.			44. On TCS request start chamber re-pressurisation. ..... / ..... 45. Ask DH to disable alarms on chamber pressure and cryo-panels temperature. ..... / ..... 46. Switch off vacuum gauge RG 1102. ..... / ..... 47. Close mass spectrometer valves. ..... / ..... 48. Switch off mass spectrometers. ..... / ..... 49. Close VV 100 valves of cryopumps 1&2. ..... / ..... 50. Close turbo pump HV valves. ..... / ..... 51. Stop turbopumps.	

Test location:	ETS / LSS	Shift leader:	PA / QA:	Date:
----------------	-----------	---------------	----------	-------

Step	Phase:	TP-L - Recovery to Ambient	FACILITY		Remarks / NCR
	TCS, CVSE, Cryo	CCS: Instruments, PLM, SVM	DATA HANDLING	LSS CONTROL	
57. At 80 mbar, check HTT, OBA, TS1, TS2, TS3 temperatures and He mass flow rate again for possible indications of CVV air leak 58. Request LSS to continue re-pressurisation				..... / ..... 52. Start chamber repressurisation with GN2 (250 mbar/h). ..... / ..... 53. Decrease mirror temperature to 26°C. ..... / ..... 54. At 1 mbar, stop MS interseal pump. ..... / ..... 55. At 80 mbar, stop chamber repressurisation 56. Inform TCS shift leader  59. On TCS request, continue with chamber repressurisation with GN2 (250 mbar/h). ..... / ..... 60. At 100 mbar, stop CP1 and CP2. ..... / ..... 61. At ambient pressure, stop facility interseal pumps. ..... / ..... 62. Stop MS auxiliaries. ..... / ..... 63. Stop C1 and C2 warm-up mode. ..... / ..... 64. Notify to test director that chamber is at atmospheric pressure. ..... / .....	
Test location:	ETS / LSS	Shift leader:	PA / QA:	Date:	

Step	Phase:	TP-L - Recovery to Ambient	FACILITY		Remarks / NCR
	TCS, CVSE, Cryo	CCS: Instruments, PLM, SVM	DATA HANDLING	LSS CONTROL	
TS#16b	66. Switch OFF all test heaters 68. Request ETS to perform <b>videogrammetry</b> measurement		67. Switch OFF all test heaters 69. On TCS request: perform <b>videogrammetry</b> measurement	65. Stop SUSI HP GN2 sub-system. ..... / .....	
TS#16c	70. Request ETS to open 5m man door  72. Request ETS to open top lid  <b>75. Transfer of S/C responsibility to SFT2 / AIT team</b>  78. Collect contamination samples and witness plates 79. Install Telescope contamination protection cover 80. Request LSS to install basic scaffolding 81. S/C removal from LSS according to AIT directions			71. On test director request, open 5-m man door. ..... / ..... 73. Install in front of man door the sign : NITROGEN DANGER DO NOT ENTER 74. On test director request, open top lid (release pressure first). ..... / ..... 76. Open 5-m door. ..... / ..... 77. <b>WARNING :</b> PROHIBIT ACCESS TO CHAMBER UNTIL OXYGEN CONTENT CHECK HAS BEEN PERFORMED. ..... / .....  82. On TCS/AIT request: install basic scaffolding	
TP-L-3 end of phase	1. Verify that end-of-phase conditions are reached	2. Prepare EOP reports as defined in <b>Annex D</b>			
Test location: ETS / LSS		Shift leader:	PA / QA:	Date:	

Step	Phase:	TP-L - Recovery to Ambient	FACILITY		Remarks / NCR
	TCS, CVSE, Cryo	CCS: Instruments, PLM, SVM	DATA HANDLING	LSS CONTROL	
3.	Fill in: Date / Time of end:           ..... / .....	4. Store CCS data (tables and rec files) on CD ROM			

**END OF TEST**

Test location: <p style="text-align: center;">ETS / LSS</p>	Shift leader:	PA / QA:	Date:
--	---------------	----------	-------

END OF DOCUMENT

	Name	Dep./Comp.		Name	Dep./Comp.
	Baldock Richard	FAE12	X	Sonn Nico	ASG51
X	Barlage Bernhard	AED13	X	Steininger Eric	AED321
	Bayer Thomas	ASA42	X	Stritter Rene	AED11
	Brune Holger	ASA45		Suess Rudi	OTN/ASA44
	Chen Bing	HE Space	X	Theunissen Martijn	DSSA
X	Davis William	Captec	X	Vascotto Riccardo	HE Space
	Edelhoff Dirk	AED21	X	Wagner Klaus	ASG23
	Fehringer Alexander	ASG15	X	Wietbrock Walter	AET12
X	Fricke Wolfgang Dr.	AED 65	X	Wöhler Hans	ASG23
	Geiger Hermann	ASA42	X	Wössner Ulrich	ASE252
X	Grasl Andreas	OTN/ASA44	X	Zumstein Armin	AED15
	Grasshoff Brigitte	AET12			
X	Hamer Simon	Terma			
X	Hanka, Erhard	FI522			
X	Hendrikse Jeffrey	HE Space			
X	Hendry David	Terma			
	Hengstler Reinhold	ASA42			
X	Hinger Jürgen	ASG23			
X	Hohn Rüdiger	AED65			
	Hopfgarten Michael	AET32			
X	Huber Johann	ASA42			
	Hund Walter	ASE252			
X	Idler Siegmund	AED312			
	Ivány von András	FAE12			
X	Jahn Gerd Dr.	ASG23			
X	Jolk Matthias	AET1	X	ESA/ESTEC	ESA
	Klenke Uwe	ASG72	X	Thales Alenia Space Cannes	TAS-F
X	Kölle Markus	ASA43	X	Thales Alenia Space Torino	TAS-I
	König Werner	AET32			
X	Koppe Axel	AED312			
X	Kroeker Jürgen	AED65		<b>Instruments:</b>	
X	La Gioia Valentina	Terma	X	MPE (PACS)	MPE
X	Lang Jürgen	ASE252	X	RAL (SPIRE)	RAL
X	Langenstein Rolf	AED15	X	SRON (HIFI)	SRON
X	Langfermann Michael	ASA41			
	Leitermann Stefan	AET12			
X	Liberatore Danilo	Rhea		<b>Subcontractors:</b>	
X	Martin Olivier	Altec		Austrian Aerospace	AAE
X	Maukisch Jan	ASA43		Austrian Aerospace	AAEM
X	Much Christoph	ASA43		BOC Edwards	BOCE
X	Müller Martin	ASA43		Dutch Space Solar Arrays	DSSA
	Pietroboni Karin	AED65		EADS Astrium Sub-Subsyst. & Equipment	ASSE
	Reichle Konrad	ASA42		EADS CASA Espacio	CASA
X	Runge Axel	OTN/ASA44		EADS CASA Espacio	ECAS
	Saal Christoph	External		European Test Services	ETS
X	Schink Dietmar	AED321		Patria New Technologies Oy	PANT
X	Schmidt Thomas	AED15		SENER Ingenieria SA	SEN
	Schweickert Gunn	ASG23		Thales Alenia Space, Antwerp	TAS-ETCA