



Titel:  
Title:

## EMC Test Procedure



Project: **HERSCHEL**  
Projekt:

Dokument Nr.: **HP-2-ASED-TP-0155**  
Document No.:

Ausgabe: **1.1** Datum: **28.11.07**  
Issue: Date:

**TITLE:** HERSCHEL S/C Level  
Conducted EMC Test Procedure

**CI-NO:** 100 000

**PREPARED BY:** Klaus Tigges / Clemens Kalde *C. Kalde* **DATE:** 29.11.07

**CHECKED BY:** Michael Hopfgarten *M. Hopfgarten* **DATE:** 29.11.07  
*J. Kroeber*

**PRODUCT ASSURANCE:** *for* René Stritter *B. Balage* **DATE:** 29.11.07

**CONFIGURATION CONTROL:** *for* Walter Wietbrock *W. Wietbrock* **DATE:** 29.11.07.

**PROJECT MANAGEMENT:** *for* Wolfgang Fricke *J. Kroeber* **DATE:** 29.11.07

*Test Director* **B. GABILLOT (TAS-F)** *[Signature]* 25/11/2007

**TEST LOCATION:** EADS Astrium GmbH, Immenstaad

**DATE OF TEST:**

**DISTRIBUTION:** See Distribution List (Last Page)

Copying of this document, and giving it to others and the use or communication of the contents there-of, are forbidden without express authority. Offenders are liable to the payment of damages. All rights are reserved in the event of the grant of a patent or the registration of a utility model or design.

**Change Record:**

| <i>Ausg./Rev.:</i><br><i>Issue/Rev.:</i> | <i>Datum:</i><br><i>Date:</i> | <i>Blatt:</i><br><i>Sheet:</i> | <i>Beschreibung der Änderung:</i><br><i>Description of Change:</i> | <i>Freigabe:</i><br><i>Release:</i> |
|--|-------------------------------|--------------------------------|--|-------------------------------------|
| 1  | 16.11.07                      |                                | Initial Issue  |                                     |
| 1.1                                      | 28.11.07                      | 9,15-17,<br>47,48              | RD 4 transfered to AD10  |                                     |
|  |                               | 16, 47,<br>48, 51-<br>54       | PACS always in Safe Mode   |                                     |
|  |                               | 23                             | Name of Test Director changed                                      |                                     |
|  |                               | 47, 48                         | References to AD 10 adapted  |                                     |
|  |                               |                                |  |                                     |
|  |                               |                                |  |                                     |
|  |                               |                                |  |                                     |
|  |                               |                                |  |                                     |
|  |                               |                                |  |                                     |
|  |                               |                                |  |                                     |
|  |                               |                                |  |                                     |

**Table of Contents:**

|          |   |           |
|----------|---|-----------|
| <b>1</b> | <b>Scope .....</b>                              | <b>7</b>  |
| 1.1      | Objective .....                                 | 7         |
| 1.2      | Test Flow.....                                  | 7         |
| 1.3      | Test Specimen .....                             | 9         |
| <b>2</b> | <b>Documents/Drawings .....</b>                 | <b>9</b>  |
| 2.1      | Applicable Documents.....                       | 9         |
| 2.2      | Reference Documents .....                       | 9         |
| <b>3</b> | <b>Configuration.....</b>                       | <b>10</b> |
| 3.1      | EGSE Configuration .....                        | 10        |
| 3.2      | Satellite Configuration .....                   | 13        |
| 3.3      | Instrumentation Selection and Calibration ..... | 18        |
| 3.4      | Facility .....                                  | 18        |
| <b>4</b> | <b>Conditions.....</b>                          | <b>20</b> |
| 4.1      | General Requirements .....                      | 20        |
| 4.2      | Environmental Conditions.....                   | 20        |
| 4.3      | Receiver/Analyser Settings .....                | 20        |
| 4.4      | General Precautions and Safety .....            | 21        |
| 4.4.1    | General Safety Requirements .....               | 21        |
| 4.4.2    | ESD constraints.....                            | 21        |
| 4.5      | Management Activities .....                     | 22        |
| 4.5.1    | Pre-Test Activities .....                       | 22        |
| 4.5.2    | Procedure Variation.....                        | 22        |
| 4.5.3    | Criteria for Failure .....                      | 22        |
| 4.5.4    | Test Completion and Post-Test Activities.....   | 22        |
| 4.6      | PA Requirements.....                            | 23        |
| 4.7      | Personnel .....                                 | 23        |

|            |  |           |
|------------|--|-----------|
| <b>5</b>   | <b>Test Requirements.....</b>  | <b>24</b> |
| <b>5.1</b> | <b>CE Current on Satellite Ground Line .....</b>                                 | <b>24</b> |
| 5.1.1      | CE Current on Satellite Ground Line Test Set-Up .....                            | 24        |
| <b>5.2</b> | <b>CE Current on Primary Power Lines.....</b>                                    | <b>24</b> |
| 5.2.1      | Requirements for CE Current on PP Lines .....                                    | 26        |
| 5.2.2      | CE Current Test Set-Up .....   | 26        |
| <b>5.3</b> | <b>CE Voltage on Primary Power Lines.....</b>                                    | <b>26</b> |
| 5.3.1      | Requirements for CE Voltage on PP Lines.....                                     | 28        |
| 5.3.2      | CE Voltage Test Set-Up on PP Lines .....   | 28        |
| <b>5.4</b> | <b>CE Current on Signal Lines .....</b>  | <b>28</b> |
| 5.4.1      | Requirements for CE Current on Signal Lines .....                                | 28        |
| 5.4.2      | CE Current Signal Lines Test Set-Up .....  | 28        |
| <b>5.5</b> | <b>CE Voltage on Signal Lines .....</b>  | <b>31</b> |
| 5.5.1      | Requirements for CE Voltage Requirements on Signal Lines.....                    | 31        |
| 5.5.2      | CE Voltage Signal Lines Test Set-Up.....   | 31        |
| <b>5.6</b> | <b>CS Voltage on Signal Lines (optional) .....</b>                               | <b>32</b> |
| 5.6.1      | Requirements for CS Voltage on Signal Lines .....                                | 32        |
| 5.6.2      | CS Signal Voltage Test Set-Up .....  | 32        |
| <b>6</b>   | <b>Test- Aid/Adapter arrangements .....</b>                                      | <b>35</b> |
| <b>6.1</b> | <b>General Test- Aid/Adapter Types.....</b>                                      | <b>35</b> |
| 6.1.1      | Power line Test Adapters .....   | 36        |
| 6.1.2      | Signal line Test Adapter .....   | 40        |
| <b>6.2</b> | <b>Arrangements for Power Lines.....</b>   | <b>42</b> |
| <b>6.3</b> | <b>Arrangements for Signal Lines.....</b>  | <b>43</b> |
| 6.3.1      | RWL adapter arrangement for measuring on DB02 Bracket .....                      | 43        |
| 6.3.2      | Optional RWL adapter arrangement for measuring on DB71 Bracket (RWL panel) ..... | 44        |
| 6.3.3      | MILBUS adapter arrangement for measuring on ACC level .....                      | 44        |
| <b>6.4</b> | <b>Test- Aid/Adapter locations/accessability on HERSCHEL.....</b>                | <b>45</b> |
| 6.4.1      | Adapter arrangement for CE tests on power- and signal lines .....                | 45        |
| 6.4.2      | Optional adapter arrangement for CE/CS tests on signal lines .....               | 46        |
| <b>7</b>   | <b>Activities Flow .....</b>   | <b>47</b> |
| <b>7.1</b> | <b>General Operational Procedures .....</b>                                      | <b>47</b> |
| <b>7.2</b> | <b>Tests Activities Flow .....</b>   | <b>49</b> |
| <b>8</b>   | <b>Step by Step Procedure/Report.....</b>  | <b>55</b> |

|             |  |            |
|-------------|--|------------|
| <b>8.1</b>  | <b>Installation of Test Adapters to Power- and Signal Lines.....</b>       | <b>55</b>  |
| <b>8.2</b>  | <b>Reference/Ambient Tests on Satellite Ground Line .....</b>              | <b>58</b>  |
| <b>8.3</b>  | <b>Reference/Ambient Tests on Power Lines.....</b>                         | <b>59</b>  |
| <b>8.4</b>  | <b>Reference/Ambient Tests on Signal Lines.....</b>                        | <b>79</b>  |
| <b>8.5</b>  | <b>Tests on Satellite Ground Line.....</b>                                 | <b>82</b>  |
| <b>8.6</b>  | <b>Conducted Emission Tests on Power Lines .....</b>                       | <b>83</b>  |
| <b>8.7</b>  | <b>Tests on Satellite Ground Line.....</b>                                 | <b>102</b> |
| <b>8.8</b>  | <b>Conducted Emission Tests on Signal Lines .....</b>                      | <b>103</b> |
| <b>8.9</b>  | <b>Conducted Susceptibility Tests on Signal Lines .....</b>                | <b>106</b> |
| <b>8.10</b> | <b>De-Installation of Test Adapters from Power- and Signal Lines .....</b> | <b>112</b> |
| <b>9</b>    | <b>Summary Sheets .....</b>  | <b>113</b> |
| <b>9.1</b>  | <b>Procedure Variation Summary .....</b>                                   | <b>113</b> |
| <b>9.2</b>  | <b>Non Conformance Report (NCR) Summary .....</b>                          | <b>113</b> |
| <b>9.3</b>  | <b>Sign-off Sheet .....</b>  | <b>113</b> |

**Table of Figures**

|  |    |
|--|----|
| Figure 3-1: Cleanroom of Astrium Friedrichshafen .....   | 19 |
| Figure 5-1: Schematic for CM and DM Measurements.....  | 26 |
| Figure 5-2: TC Test Adapter arrangement for CE, DB02 level.....                                  | 29 |
| Figure 5-3: TDC Test Adapter arrangement for CE, DB02 level .....                                | 29 |
| Figure 5-4: Optional TC/TDC Test Adapter arrangement for CE, DB 71 level.....                    | 30 |
| Figure 5-5: TC Test Adapter arrangement for CS, DB02 level.....                                  | 33 |
| Figure 5-6: TDC Test Adapter arrangement for CS, DB02 level .....                                | 33 |
| Figure 5-7: TC/TDC Test Adapter arrangement for CS (optional, for measurements on the RWL panel) | 34 |
| Figure 6-1: Test Adapter, General Configuration.....   | 35 |
| Figure 6-2: Test Adapter, Current Probe Arrangement.....   | 36 |
| Figure 6-3: Test Adapter DB01-J01 .....  | 36 |
| Figure 6-4: Test Adapter DB01-J02 .....  | 37 |
| Figure 6-5: Test Adapter DB01-J04 .....  | 37 |
| Figure 6-6: Test Adapter DB01-J05 .....  | 38 |
| Figure 6-7: Test Adapter for DB01-J06.....   | 39 |
| Figure 6-8: Test adapter DB02-P01 .....  | 40 |
| Figure 6-9: Optional test adapter DB71-J02 (for RWL panel only!).....                            | 41 |
| Figure 6-10: Test adapter ACC-J23 (L3 is < 10 cm, L2 is < 5 cm).....                             | 41 |

**Table of Tables**

|   |     |
|---|-----|
| Table 1-1: Satellite Conducted EMC Test Flow .....              | 8   |
| Table 3-1: EGSE Configuration for the REFERENCE Mode .....      | 10  |
| Table 3-2: EGSE Configuration for the NOISIEST Mode.....        | 11  |
| Table 3-3: EGSE Configuration for the SENSITIVE Mode.....       | 12  |
| Table 3-4: Satellite Configuration for the REFERENCE Mode ..... | 14  |
| Table 3-5: Satellite Configuration for the NOISIEST Mode.....   | 16  |
| Table 3-6: Satellite Configuration for the SENSITIVE Mode.....  | 18  |
| Table 3-7: Test Equipment List.....                             | 18  |
| Table 4-1: Receiver/Analyser Settings .....                     | 20  |
| Table 4-2: Personnel .....                                      | 23  |
| Table 7-1: Test Activities Flow.....                            | 54  |
| Table 8-1: Frequency Table for CS Injection on TC Line .....    | 108 |
| Table 8-2: Frequency Table for CS Injection on TDC Line .....   | 111 |
| Table 9-1: Procedure Variation Sheet .....                      | 113 |
| Table 9-2: Non- Conformance Record Sheet.....                   | 113 |

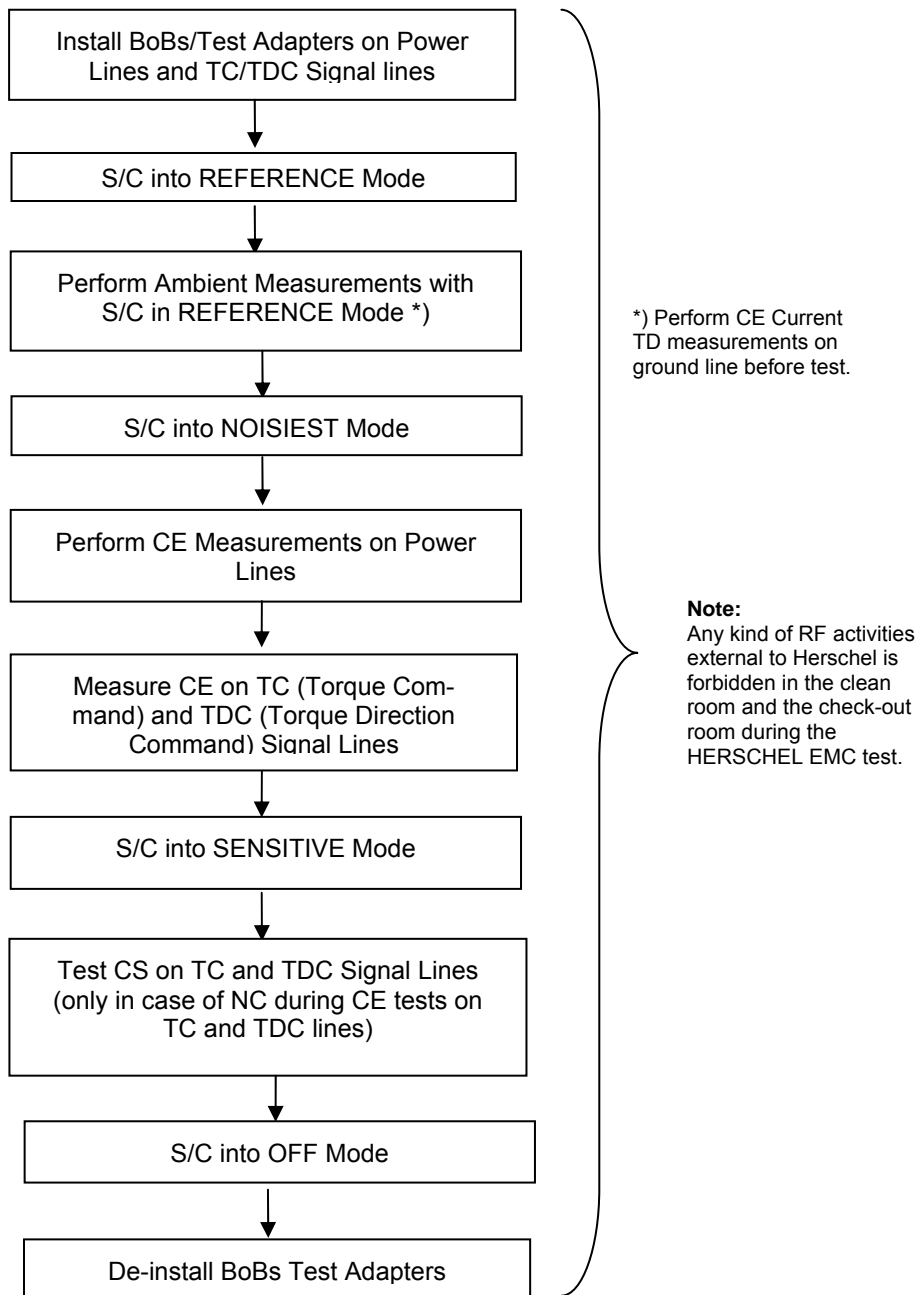
## **1 SCOPE**

### **1.1 Objective**

This procedure describes the activities to be carried out for the Conducted EMC Test of the satellite. The objective of this activity is to confirm the system level compatibility margins concerning the conducted EMC requirements.

### **1.2 Test Flow**

A general test flow is shown in the **Table 1-1** below.



**Table 1-1:** Satellite Conducted EMC Test Flow



### 1.3 Test Specimen

The test specimen is the satellite. The model is the PFM.

## 2 DOCUMENTS/DRAWINGS

### 2.1 Applicable Documents

The following documents in their latest issue are applicable to this procedure:

|      |                    |   |           |
|------|--------------------|---|-----------|
| AD1  | HP-2-ASED-PL-00007 | Herschel PA Plan  | Issue 2.1 |
| AD2  | HP-2-ASED-PL-0023  | Herschel Contamination Control Plan   | Issue 2   |
| AD3  | H-P-2-ASP-ID-0621  | HERSCHEL PLM Electrical Interface Control Document, EICD                                    | Issue 3   |
| AD4  | H-P-IC-AI-0003     | HERSCHEL/PLANCK SVM Electrical ICD  | Issue 6   |
| AD5  | H-P-1-ASPI-SP-0027 | General Design and Interface Requirements   | Issue 5   |
| AD6  | H-P-1-ASPI-SP-0037 | HERSCHEL/PLANCK EMC Specification   | Issue 4.0 |
| AD7  | H-P-1-ASPI-PL-0038 | HERSCHEL/PLANCK EMC/ESD Control Plan  | Issue 3   |
| AD8  | H-P-2-ASP-TS-0819  | HERSCHEL FM EMC Test Requirements Specification   | Issue 4   |
| AD9  | H-P-DW-AI-0004     | HERSCHEL FM EGSE to SVM connection diagrams   | Issue 1   |
| AD10 | HP-2-ASED-PR-0100  | Herschel EGSE & Satellite & Instrument Procedure for the SAT EMC CE Test in Warm Conditions | 1.0       |
|      |                    |   |           |

### 2.2 Reference Documents

In this section all documents are given which either

- could serve as reference for the conducted tests, or
- may be referred in the test report for clarification/justification of an outcome (result) of the test.

|     |                   |  |    |
|-----|-------------------|--|----|
| RD1 | H-P-PR-AI-0091    | HERSCHEL PFM SVM – EMC Confidence Test Procedure                   | 01 |
| RD2 | H-P-RP-AI-0176    | HERSCHEL PFM SVM – EMC Confidence Test Report                      | 01 |
| RD3 | H-P-RP-AI-0166    | Conducted Susceptibility CM on RWL's TOCO and TD lines Test Report | 01 |
| RD4 |                   | Now AD 10  |    |
| RD5 | H-P-2-ASP-TN-1406 | Herschel FM EMC CE Data Collection                                 | 1  |
|     |                   |  |    |
|     |                   |  |    |

### 3 CONFIGURATION

#### 3.1 EGSE Configuration

The configuration is the PFM of the satellite in combination with the EGSE and SCOE in accordance to the AD9.

The configuration of the used EGSE as used for the REFERENCE, NOISIEST and SENSITIVE Mode are shown in the next tables. In OFF Mode, all EGSE is switched off.

| Subsystem  | Configuration for REFERENCE Mode  |
|------------|---|
| TM/TC DFE  | <ul style="list-style-type: none"> <li>• Online</li> <li>• TM Chain A</li> <li>• TC Chain A</li> <li>• Archiving ON</li> </ul>  |
| CDMU SCOE  | <ul style="list-style-type: none"> <li>• Not used</li> </ul>  |
| Power SCOE | Battery Simulator Nominal Set: <ul style="list-style-type: none"> <li>• Offline but the SCOE is switched on</li> <li>• Vbat = 24 V</li> <li>• Icharge = 10 A</li> <li>• Idisch = 16 A</li> <li>• OVP = 27 V</li> <li>• OCP = ON</li> </ul> Solar Array Simulator Nominal Set: <ul style="list-style-type: none"> <li>• Offline but the SCOE is switched on</li> <li>• Voc = 43 V</li> <li>• Isc = 2.0 A</li> <li>• Rs = 0.1</li> <li>• N = 100</li> <li>• Vprot = 45 V</li> <li>• Iprot (FPCS) less than 3.3 A</li> <li>• AIT BDR 1 and BDR 2 = ON</li> <li>• Separation Straps 1 to 8 = not separated</li> <li>• SA Temp simulation set to 110 °C</li> </ul> |
| ACMS SCOE  | <ul style="list-style-type: none"> <li>• Closed loop configuration to support OCM. RWLs not running.</li> </ul>   |
| TT&C SCOE  | All instruments ON and RF cables connected to TT&C subsystem in order to provide <ul style="list-style-type: none"> <li>• RF downlink signal spectrum monitoring</li> </ul>   |

**Table 3-1: EGSE Configuration for the REFERENCE Mode**

| Subsystem  | Configuration for NOISIEST Mode   |
|------------|---|
| TM/TC DFE  | <ul style="list-style-type: none"> <li>• Online</li> <li>• TM Chain A</li> <li>• TC Chain A</li> <li>• Archiving ON</li> </ul>  |
| CDMU SCOE  | <ul style="list-style-type: none"> <li>• Not used</li> </ul>  |
| Power SCOE | <p>Battery Simulator Nominal Set:</p> <ul style="list-style-type: none"> <li>• Online</li> <li>• Vbat = 24 V</li> <li>• Icharge = 10 A</li> <li>• Idisch = 16 A</li> <li>• OVP = 27 V</li> <li>• OCP = ON</li> </ul> <p>Solar Array Simulator Nominal Set:</p> <ul style="list-style-type: none"> <li>• Online</li> <li>• Voc = 43 V</li> <li>• Isc = 2.0 A</li> <li>• Rs = 0.1</li> <li>• N = 100</li> <li>• Vprot = 45 V</li> <li>• Iprot (FPCS) less than 3.3 A</li> <li>• AIT BDR 1 and BDR 2 = ON</li> <li>• Separation Straps 1 to 8 = separated</li> <li>• SA Temp simulation set to 110 °C</li> </ul> |
| ACMS SCOE  | <ul style="list-style-type: none"> <li>• Closed loop configuration to support OCM</li> <li>• RWL's spin up at 1000 rpm</li> </ul>   |
| TT&C SCOE  | <p>All instruments ON and RF cables connected to TT&amp;C subsystem in order to provide</p> <ul style="list-style-type: none"> <li>• RF downlink signal spectrum monitoring</li> </ul>  |

**Table 3-2: EGSE Configuration for the NOISIEST Mode**

| Subsystem  | Configuration for SENSITIVE Mode  |
|------------|---|
| TM/TC DFE  | <ul style="list-style-type: none"> <li>• Online</li> <li>• TM Chain A</li> <li>• TC Chain A</li> <li>• Archiving ON</li> </ul>  |
| CDMU SCOE  | <ul style="list-style-type: none"> <li>• Not used</li> </ul>  |
| Power SCOE | <p>Battery Simulator Nominal Set:</p> <ul style="list-style-type: none"> <li>• Online</li> <li>• Vbat = 24 V</li> <li>• Icharge = 10 A</li> <li>• Idisch = 16 A</li> <li>• OVP = 27 V</li> <li>• OCP = ON</li> </ul> <p>Solar Array Simulator Nominal Set:</p> <ul style="list-style-type: none"> <li>• Online</li> <li>• Voc = 43 V</li> <li>• Isc = 2.0 A</li> <li>• Rs = 0.1</li> <li>• N = 100</li> <li>• Vprot = 45 V</li> <li>• Iprot (FPCS) less than 3.0 A</li> <li>• AIT BDR 1 and BDR 2 = ON</li> <li>• Separation Straps 1 to 8 = separated</li> <li>• SA Temp simulation set to 110 °C</li> </ul> |
| ACMS SCOE  | <ul style="list-style-type: none"> <li>• Closed loop configuration to support OCM (RWLs not running)</li> </ul>   |
| TT&C SCOE  | <p>All instruments ON and RF cables connected to TT&amp;C subsystem in order to provide</p> <ul style="list-style-type: none"> <li>• RF downlink signal spectrum monitoring</li> </ul>  |

**Table 3-3: EGSE Configuration for the SENSITIVE Mode**

### 3.2 Satellite Configuration

The configuration of the used satellite as used for the REFERENCE, NOISIEST and SENSITIVE Mode is shown in the next tables. In OFF Mode the satellite is switched off.

| Subsystem/ Unit       | Configuration for REFERENCE Mode |
|-----------------------|----------------------------------|
| <b>Power Panel</b>    |                                  |
| CDMU                  | OFF                              |
| ACC                   | OFF                              |
| PCDU                  | OFF                              |
| Battery               | OFF                              |
| <b>TTC Panel</b>      |                                  |
| EPC1                  | OFF                              |
| TWT1                  | OFF                              |
| EPC2                  | OFF                              |
| TWT2                  | OFF                              |
| XPND1                 | OFF                              |
| XPND2                 | OFF                              |
| RFDN                  | OFF                              |
| <b>AOCS sensors</b>   |                                  |
| STR1                  | OFF                              |
| STR2                  | OFF                              |
| CRS1                  | OFF                              |
| CRS2                  | OFF                              |
| RWL-1                 | OFF                              |
| RWL-2                 | OFF                              |
| RWL-3                 | OFF                              |
| RWL-4                 | OFF                              |
| GYRO A                | OFF                              |
| GYRO B                | OFF                              |
| SAS                   | OFF                              |
| AAD                   | OFF                              |
| <b>Propulsion</b>     |                                  |
| PT                    | OFF                              |
| 20N thrusters cat bed | OFF                              |
| Latch valve           | OFF                              |
| <b>Miscellaneous</b>  |                                  |
| SREM                  | OFF                              |
| VMC                   | OFF                              |
| <b>SPIRE Panel</b>    |                                  |
| HSDPU N               | OFF                              |
| HSDPU R               | OFF                              |
| HSFCU N               | OFF                              |
| HSFCU R               | OFF                              |
| HSDCU N               | OFF                              |
| HSDCU R               | OFF                              |

| <b>Subsystem/ Unit</b> | <b>Configuration for REFERENCE Mode</b> |
|------------------------|---|
| CCU A                  | OFF                                     |
| CCU B                  | OFF                                     |
|                        |   |
| <b>PACS Panel</b>      |   |
| FPSPU N                | OFF                                     |
| FPSPU R                | OFF                                     |
| FPDPU N                | OFF                                     |
| FPDPU R                | OFF                                     |
| FPDEC/MEC1             | OFF                                     |
| FPDEC/MEC2             | OFF                                     |
| FPBOLC N               | OFF                                     |
| FPBOLC R               | OFF                                     |
|                        |   |
| <b>HIFI Panels</b>     |   |
| FHWEH                  | OFF                                     |
| FHWEV                  | OFF                                     |
| FHLCU N                | OFF                                     |
| FHLCU R                | OFF                                     |
| FHHRH                  | OFF                                     |
| FHHRV                  | OFF                                     |
| FHICU N                | OFF                                     |
| FHICU R                | OFF                                     |

**Table 3-4: Satellite Configuration for the REFERENCE Mode**

| Subsystem/ Unit       | Configuration for NOISIEST Mode   |
|-----------------------|---|
| <b>Power Panel</b>    | See <b>AD10</b> for Mode definition   |
| CDMU                  | ON, NOM   |
| ACC                   | ON, in STANDBY  |
| PCDU                  | ON  |
| Battery               | Not connected   |
| <b>TTC Panel</b>      |   |
| EPC1                  | ON  |
| TWT1                  | ON  |
| EPC2                  | OFF   |
| TWT2                  | OFF   |
| XPND1                 | ON, RX + TX   |
| XPND2                 | ON, but only RX   |
| RFDN                  | /   |
| <b>AOCS sensors</b>   | See <b>AD10</b> for Mode definition   |
| STR1                  | ON, Dumping Mode  |
| STR2                  | STB   |
| CRS1                  | ON  |
| CRS2                  | ON  |
| RWL-1                 | ON  |
| RWL-2                 | ON  |
| RWL-3                 | ON  |
| RWL-4                 | ON  |
| GYRO A                | ON  |
| GYRO B                | OFF   |
| SAS                   | /   |
| AAD                   | /   |
| <b>Propulsion</b>     | See <b>AD10</b> for Mode definition   |
| PT                    | ON  |
| 20N thrusters cat bed | OFF   |
| Latch valve           | OFF   |
| <b>Miscellaneous</b>  |   |
| SREM                  | ON  |
| VMC                   | ON  |
|                       |   |
| <b>SPIRE Panel</b>    | Set the mode according to <b>AD10</b><br><b>IMPORTANT: SPIRE in Science Mode for tests on SPIRE power lines. Else SPIRE in Standby Mode</b> |
| HSDPU N               | ON  |
| HSDPU R               | OFF   |
| HSFCU N               | ON  |
| HSFCU R               | OFF   |
| HSDCU N               | ON  |
| HSDCU R               | OFF   |
| CCU A                 | ON set mode according to <b>AD10</b>  |
| CCU B                 | ON set mode according to <b>AD10</b>  |
|                       |   |

| Subsystem/ Unit    | Configuration for NOISIEST Mode   |
|--------------------|---|
| <b>PACS Panel</b>  | Set the mode according to <b>AD10</b><br><b>IMPORTANT: PACS in Safe Mode for all tests.</b>   |
| FPSPU N            | ON  |
| FPSPU R            | OFF   |
| FPDPU N            | ON  |
| FPDPU R            | OFF   |
| <b>FP/MEC1</b>     | ON  |
| FPDEC/MEC2         | OFF   |
| FPBOLC N           | ON  |
| FPBOLC R           | OFF   |
|                    |   |
| <b>HIFI Panels</b> | Set the mode according to <b>AD10</b><br><b>IMPORTANT: HIFI in Science Mode for tests on HIFI power lines and for tests on AOCS signal lines. Else HIFI in Standby Mode</b> |
| FHWEH              | ON  |
| FHWEV              | ON  |
| FHLCU N            | ON  |
| FHLCU R            | OFF   |
| FHHRH              | ON  |
| FHHRV              | ON  |
| FHICU N            | ON  |
| FHICU R            | OFF   |

**Table 3-5: Satellite Configuration for the NOISIEST Mode**



| Subsystem/ Unit       | Configuration for SENSITIVE Mode     |
|-----------------------|--------------------------------------|
| <b>Power Panel</b>    | See <b>AD10</b> for Mode definition  |
| CDMU                  | ON, NOM                              |
| ACC                   | ON, in STANDBY                       |
| PCDU                  | ON                                   |
| Battery               | Not connected                        |
| <b>TTC Panel</b>      | See <b>AD10</b> for Mode definition  |
| EPC1                  | ON                                   |
| TWT1                  | ON                                   |
| EPC2                  | OFF                                  |
| TWT2                  | OFF                                  |
| XPND1                 | ON, RX + TX                          |
| XPND2                 | ON, but only RX                      |
| RFDN                  | /                                    |
| <b>AOCS sensors</b>   | See <b>AD10</b> for Mode definition  |
| STR1                  | ON, Dumping Mode                     |
| STR2                  | STB                                  |
| CRS1                  | ON                                   |
| CRS2                  | ON                                   |
| RWL-1                 | ON                                   |
| RWL-2                 | ON                                   |
| RWL-3                 | ON                                   |
| RWL-4                 | ON                                   |
| GYRO A                | ON                                   |
| GYRO B                | OFF                                  |
| SAS                   | /                                    |
| AAD                   | /                                    |
| <b>Propulsion</b>     | See <b>AD10</b> for Mode definition  |
| PT                    | ON                                   |
| 20N thrusters cat bed | OFF                                  |
| Latch valve           | OFF                                  |
| <b>Miscellaneous</b>  | See <b>AD10</b> for Mode definition  |
| SREM                  | ON                                   |
| VMC                   | ON                                   |
|                       |                                      |
| <b>SPIRE Panel</b>    |                                      |
| HSDPU N               | OFF                                  |
| HSDPU R               | OFF                                  |
| HSFCU N               | OFF                                  |
| HSFCU R               | OFF                                  |
| HSDCU N               | OFF                                  |
| HSDCU R               | OFF                                  |
| CCU A                 | ON set mode according to <b>AD10</b> |
| CCU B                 | ON set mode according to <b>AD10</b> |
|                       |                                      |
| <b>PACS Panel</b>     |                                      |
| FPSPU N               | OFF                                  |

| Subsystem/ Unit    | Configuration for SENSITIVE Mode |
|--------------------|----------------------------------|
| FPSPU R            | OFF                              |
| FPDPU N            | OFF                              |
| FPDPU R            | OFF                              |
| FPDEC/MEC1         | OFF                              |
| FPDEC/MEC2         | OFF                              |
| FPBOLC N           | OFF                              |
| FPBOLC R           | OFF                              |
|                    |                                  |
| <b>HIFI Panels</b> |                                  |
| FHWEH              | OFF                              |
| FHWEV              | OFF                              |
| FHLCU N            | OFF                              |
| FHLCU R            | OFF                              |
| FHHRH              | OFF                              |
| FHHRV              | OFF                              |
| FHICU N            | OFF                              |
| FHICU R            | OFF                              |

**Table 3-6: Satellite Configuration for the SENSITIVE Mode**

### 3.3 Instrumentation Selection and Calibration

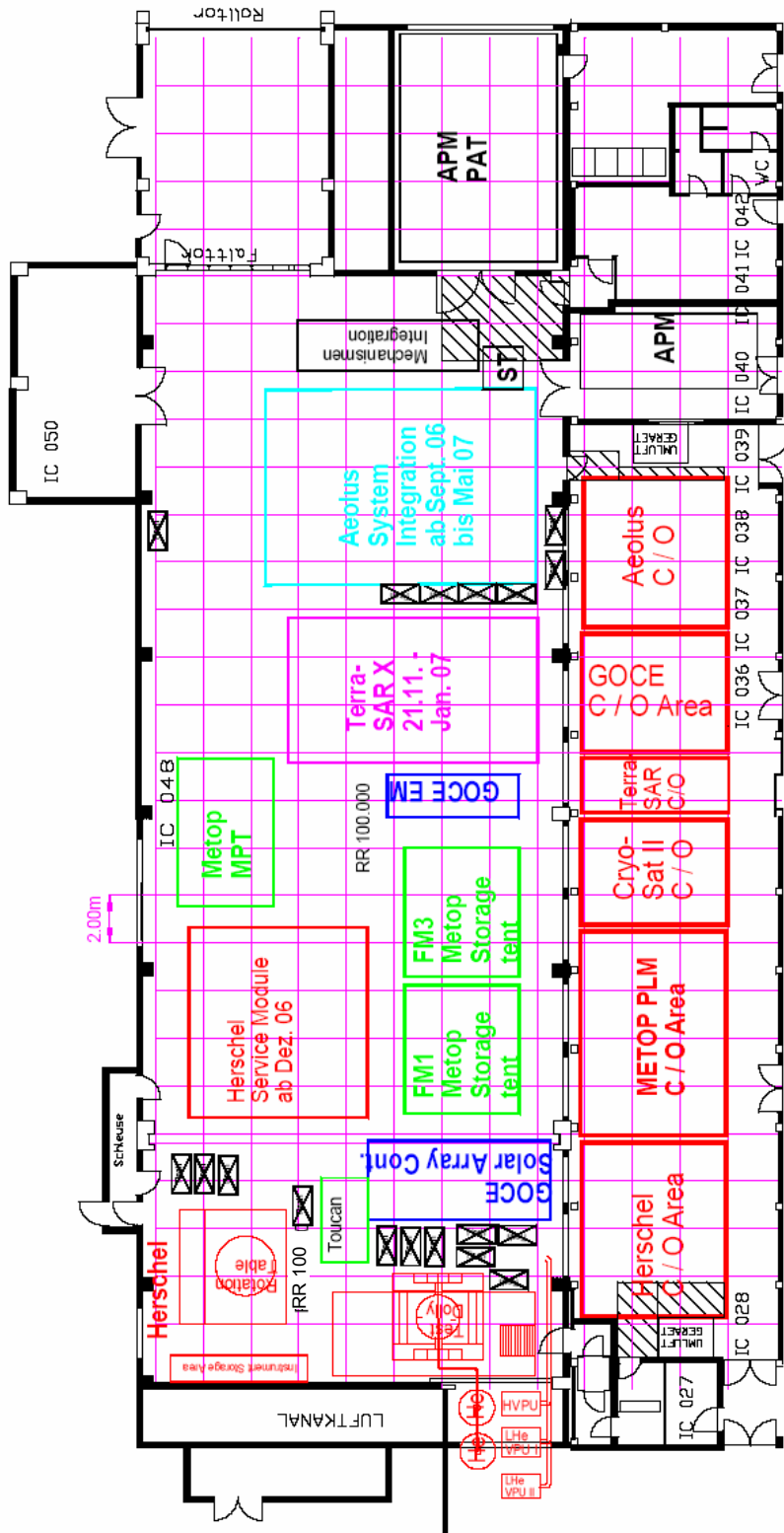
Instrumentation used during the test shall be within its certification period and selected for use in tests such that it meets the specified accuracy requirements. Each instrument Model/Type number and Invent No. shall be recorded with its certification status into the equipment list for every test. The functionality of the test article shall be systematically verified during hardware acceptance testing. The test equipment list shall be included in the test report.

| Equipment: | Manufacturer: | Type: | Inventar No: | Next Cal |
|------------|---------------|-------|--------------|----------|
|            |               |       |              |          |
|            |               |       |              |          |
|            |               |       |              |          |

**Table 3-7: Test Equipment List**

### 3.4 Facility

The activities as detailed in this procedure shall be carried out in the EADS Astrium clean room class 100 in Friedrichshafen. See **Figure 3-1** below.



**Figure 3-1:** Cleanroom of Astrium Friedrichshafen

## 4 CONDITIONS

### 4.1 General Requirements

- The handling of the test set-up shall be in accordance with controlled procedure only
- Handling, mechanical and electrical, has to be done only by qualified personnel
- Test item has to be switched-off when changing the Test Configuration

### 4.2 Environmental Conditions

All activities specified in the procedure have to be performed in a clean room class 100.

Temperature:                      22°C +/- 3°C  
Relative Humidity:                40% to 60%

The cleanliness requirements will be observed throughout the activities, and the overall contamination control requirements identified in the Herschel Contamination Control Plan, AD2, will be observed.

### 4.3 Receiver/Analyser Settings

Using the MIL-STD-461E, the following table shall serve as guideline for receiver bandwidth and data presentation. It is strongly recommended to show only about 2 decades within one plot.

Conducted Emissions, NB:

| Plot   | MIL-STD-461E     |                         | Analyser Settings (Peak detection Mode/Max. Hold) |          |                                 |            |
|--------|------------------|-------------------------|---|----------|---------------------------------|------------|
|        | f- range         | Min. Meas. Time         | ResBW (3 dB)                                      | Video BW | Sweep Points/virtual Stepp size | Sweep-time |
| Plot 1 | 30 Hz – 1 kHz    | 0,015 s/Hz (ca. 15 s)   | 10 Hz   | 30 Hz    | 251/3,9 Hz < ResBW              | 20 s       |
| Plot 1 | 1 kHz – 10 kHz   | 0,15 s/kHz (ca. 1,5 s)  | 100 Hz  | 300 Hz   | 251/36 Hz < ResBW               | 10 s       |
| Plot 2 | 10 kHz – 150 kHz | 0,015 s/kHz (ca. 2,2 s) | 1 kHz   | 3 kHz    | 251/560 Hz < ResBW              | 10 s       |
| Plot 2 | 150 kHz – 1 MHz  | 1,5 s/MHz (ca. 1,5 s)   | 10 kHz  | 30 kHz   | 251/3,4 kHz < ResBW             | 10 s       |
| Plot 3 | 1 MHz – 30 MHz   | 1,5 s/MHz (ca. 45 s)    | 10 kHz  | 30 kHz   | 4001/7,25 kHz < ResBW           | 50 s       |
| Plot 4 | 30 MHz – 50 MHz  | 0,15 s/MHz (ca. 3 s)    | 100 kHz   | 300 kHz  | 501/40 kHz < ResBW              | 10 s       |

**Table 4-1:** Receiver/Analyser Settings

## 4.4 General Precautions and Safety

### 4.4.1 General Safety Requirements

No special hazards are expected. The application of the standard technical rules for mechanical and electrical integration and test activities is sufficient.

Lower level procedures called up by this procedure may define their own safety requirement in the relevant chapters which must be respected accordingly.

Any open waveguides of HIFI shall be closed by copper tape or a dummy load, details on the configuration to be defined during the TRR.

The RF antennas shall be covered by the antenna test caps or removed and the antenna ports loaded by suitable RF load in order to avoid RF transmission in command failure case.

#### **Special precautions concerning EMC test:**

During the EMC test, special measurement adapters on power- and signal lines shall be installed to get access to the lines under test.

**It is absolutely mandatory to fix the EMC adapter connectors mechanically against disconnecting by accident or stress!**

**Pay special attention when clamping and unclamping the measurement transducers (e.g. voltage- and current probes) to and from the EMC adapter wires. Wires may break under stress.**

### 4.4.2 ESD constraints

In order to prevent ESD sensitive H/W from any possible damages by accidental electrostatic discharges an ESD protected area must be defined and setup during ESD sensitive activities:

- Floor and test bench of the ESD protected area has to be covered with anti-static mats
- During all handling activities (as transport, mounting, mating/de-mating of connectors, measurements with individual measurement devices, etc.) the operator has to work on anti static mats with correct clothing and personal grounding-straps
- Adequate ESD clothing is required:
  - Anti static coat
  - Anti static gloves
  - Anti static boots
- Transportation of ESD sensitive H/W will be made only in ESD protective bag or box.

## **4.5 Management Activities**

### **4.5.1 Pre-Test Activities**

At least the following tasks have to be successfully completed before start of integration and test activities according to this procedure:

- This procedure released and accepted
- Formal release to start given by the board following review of relevant test procedures and test configurations.

### **4.5.2 Procedure Variation**

Major activities deviating from the approved test procedure require the agreement of Project, AIV and PA responsible, and shall be documented via Activity Control Sheets (ACS). All ACS's generated in the frame of the execution of this procedure shall be listed in the ACS Summary Sheet.

### **4.5.3 Criteria for Failure**

If the results of any test performed using this procedure or a lower level procedure which this procedure refers to yields a value which lies outside the specified limits, it shall be considered as a non-conformance. Initial analysis of the result will be applied to establish whether the result is due to measurement error or incorrect specification limits. A NCR will then be raised to report the non-conformance. Depending on the magnitude of the non-conformance, and its impact, either a minor or a major NCR will be raised. In case of major NCR the test shall be continued only upon written or verbal authorisation of Customer (Alcatel and ESA). All NCR's raised in the frame of the execution of this procedure shall be listed in the NCR Summary Sheet.

The NCR process is described in the Herschel PA Plan, AD1.

### **4.5.4 Test Completion and Post-Test Activities**

All data that has been recorded during the test activities specified in this procedure shall be collected and retained in a centralised reference volume, and will include:

- PFM logbook
- Relevant CCS logs
- Photographs and plots
- Filled out test procedure
- Activity Control Sheets (ACS), if any
- Copies of NCR's, if any

All these test data shall be available for presentation at the Test Review Board (TRB) which will finally conclude on the test.

A test report shall be produced whose contents shall be as follows:

- Brief summary of the test results
- "As-run" test procedure as an annex (this includes housekeeping data, temperature curves, etc.).
- List of NCR's raised
- List of ACS's generated.
- Relevant meeting minutes (e. g. TRR, TRB)
- Filled out Sign-off Sheet (see section 9.3 of this procedure).

#### 4.6 PA Requirements

Quality Assurance shall monitor all operations (handling, transportation, disassembly, installation and test) as necessary to assure compliance with this procedure and the applicable requirements of the Herschel PA Plan, AD1.

In the course of this procedure PA shall pay particular attention to:

- the application of adequate protections to critical surfaces
- the records in the log-sheet
- the recording of the serial number of the test equipment used
- ensure that the test equipment used is within actual calibration cycle

PA has to make sure that NCR's are raised when applicable and treated by NRB procedure as defined in the Herschel PA Plan, AD1.

#### 4.7 Personnel

| <b>Title</b>        | <b>Function</b>  | <b>Name</b>        |
|---------------------|--|--------------------|
| Test Director       | Overall Responsible  | Benoit Gobillot    |
| Test Conductor      | EMC Test Responsibility  | Michael Hopfgarten |
| Test Engineer       | EMC Test Definition  | Clemens Kalde      |
| Test Engineer       | EMC Test Equipment Responsible   | Hubert Stiehle     |
| EGSE Operator       | Operate EGSE   | See TRR            |
| Mech. Operator(s)   | All mech. Integration activities, handles the Satellite during testing | See TRR            |
| Satellite Operators | Operate the satellite during testing                                   | See TRR            |
| PA Representative   | To ensure PA requirements  | Dave Hendry        |

**Table 4-2:** Personnel

## 5 TEST REQUIREMENTS

### 5.1 CE Current on Satellite Ground Line

No (significant) current shall flow through the satellites ground line. Object of this test is to check the current on the satellites ground line and compare the measured value with the expected value of about 50 mApp. DC currents shall also be measured with this measurement (min. DC current detectable will be about 10 ... 20 mApp).

The measurement shall be done with the S/C in REFERENCE Mode prior to the reference tests on power lines.

Measure the current ripple in time domain (TD). The measurement shall be taken in the frequency range from DC to 50 MHz.

#### 5.1.1 CE Current on Satellite Ground Line Test Set-Up

The grounding wire shall be connected to the power panel grounding starpoint location (insert at the right side below the panel when panel is opened). **For the change of the grounding starpoint from the trolley to the grounding starpoint connection, it must be ensured by parallel connection that the satellite will never be without grounding (floating).**

### 5.2 CE Current on Primary Power Lines

Objective of this test is to provide confirmation that the conducted **current** emissions, measured on the primary power lines towards PCDU are compliant with specification.

This test is performed to fulfil EMC requirement EMCPLM-000 and EMCSYS-092 of HERSCHEL EMC Specification [AD6].

The following lines shall be tested:

- HIFI-LCU
- HIFI-ICU
- SPIRE-FCU
- PACS-DPU
- PACS-SPU
- CCU
- PACS-BOLC
- PACS-MEC

Furthermore the tests in accordance to EMCSYS-096 shall be performed:

- TWTA
- STR1

In **frequency domain** the test shall be performed in common mode and differential Mode. In **time domain** only differential measurements are applicable.



A **reference measurement** with Spacecraft OFF / EGSE ON before the test shall identify any emissions generated by the support or external power equipment.

### 5.2.1 Requirements for CE Current on PP Lines

#### CE Current Time Domain:

The minimum bandwidth used for time domain measurement shall be 50MHz. The actual DC currents shall be measured prior to test and documented in the test procedure/-report.

The results shall be compared with the results as got on subsystem and unit level (refer to RD-7) and analysed by ESA/ TAS.

#### CE Current Frequency domain:

In the frequency range 30 Hz – 50 MHz, the conducted emission on power lines shall be recorded and provided to the EMC team of ASPI/ESA for analysis. The CE shall be deemed by comparison with subsystem and unit test level results (refer to RD-7), and assessed by TAS and ESA.

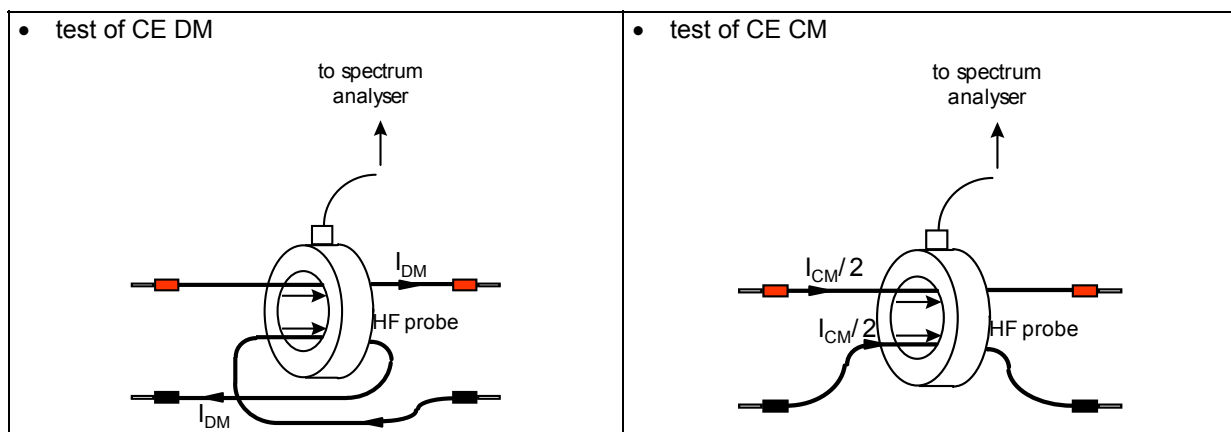
### 5.2.2 CE Current Test Set-Up

The power line connection on the PCDU side shall be interrupted by specifically built test aids in order to get access to the power lines and to enable the measurements in time and frequency domain.

The frequency domain measurements shall be taken with a current probe and a spectrum analyser whereas an oscilloscope will be used for the time domain measurements.

A photograph shall be taken from the set-up, showing break-out boxes, the PCDU power connectors, the test cables and the current probe.

The principle to be applied for the common mode and differential mode measurements is shown in the figure below.



**Figure 5-1: Schematic for CM and DM Measurements**

### 5.3 CE Voltage on Primary Power Lines

Objective of this test is the measurement of conducted **voltage** emissions on the primary power lines towards PCDU.

This test is performed to fulfil EMC requirement EMCPLM-000 and EMCSYS-092 of HERSCHEL EMC Specification [AD6].

The following lines shall be tested:

- HIFI-LCU
- HIFI-ICU
- SPIRE-FCU
- PACS-DPU
- PACS-SPU
- CCU
- PACS-BOLC
- PACS-MEC

Furhtermore the tests in accordance to EMCSYS-096 shall be added:

- TWTA
- STR1

The test shall be done in **time domain**, differential mode and common mode (between the return line and the satellite structure).

A **background measurement** with Spacecraft OFF / EGSE ON before the test shall identify any emissions generated by the support or external power equipment.

### 5.3.1 Requirements for CE Voltage on PP Lines

The conducted emission voltage on power lines (both, between Plus>Returns and Return/Structure) shall be deemed by comparison with unit/satellite test level results and assessed by the EMC team. The minimum bandwidth used for measurement shall be 50 MHz. Only periodic components are considered to contribute to "ripple".

### 5.3.2 CE Voltage Test Set-Up on PP Lines

The power line connection on the PCDU side shall be interrupted by test adapters in order to get access to the power lines and to enable the time domain voltage measurements.

The measurement shall be taken with an oscilloscope.

A photograph shall be taken from the set-up, showing break-out boxes/test adapter, the test cables and the voltage probe.

## 5.4 CE Current on Signal Lines

Objective of this test is to check that the conducted current emissions on ACC-RWL signal lines TC and TDC are compliant with specification. This test is performed to fulfil EMC requirement EMCSYS-096 of HERSCHEL EMC Specification [AD6].

The following signal lines shall be tested:

- Torque Command (TC)
- Torque Direction Command (TDC)

The test shall be done in **frequency domain, common mode (CM)**.

A **background measurement** with Spacecraft OFF / EGSE ON before the test shall identify any emissions generated by the support or external power equipment.

### 5.4.1 Requirements for CE Current on Signal Lines

In the frequency range 30 Hz – 50 MHz, the conducted current emission on signal lines shall not exceed 77 dB $\mu$ A rms.

### 5.4.2 CE Current Signal Lines Test Set-Up

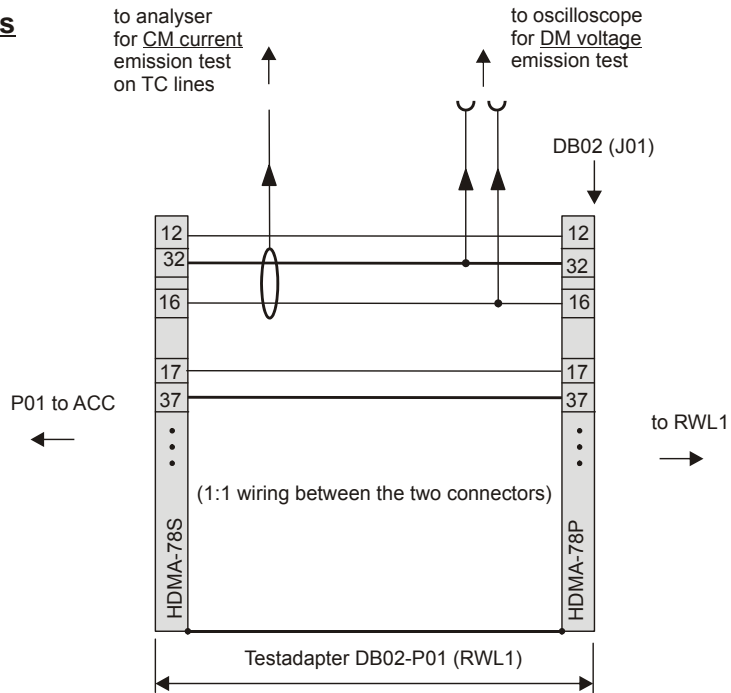
The TC and TDC signal lines shall be interrupted by a test adapter placed at DB02 level in order to get access to the lines for common mode measurement in accordance to Figure 5-2 and Figure 5-3 below and paragraph 6.3.1.

As an option only the TC and TDC signal lines may be interrupted by a test adapter placed at DB71 level, see Figure 5-4 and paragraph 6.3.2.

The measurement shall be taken with a current probe connected to a spectrum analyser.

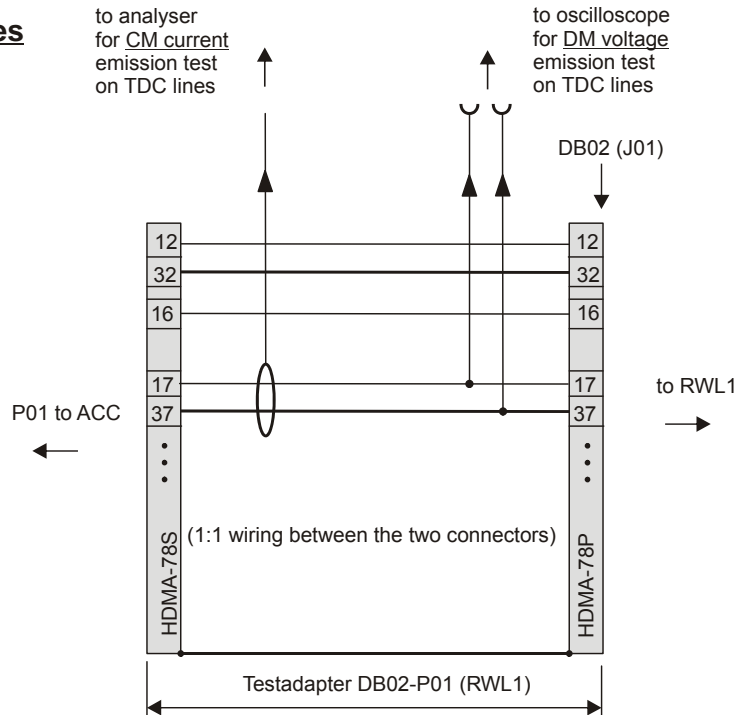
A photograph shall be taken from the set-up, showing break-out boxes, the PCDU power connectors and the test cables and the voltage probe.

**CE on TC lines**

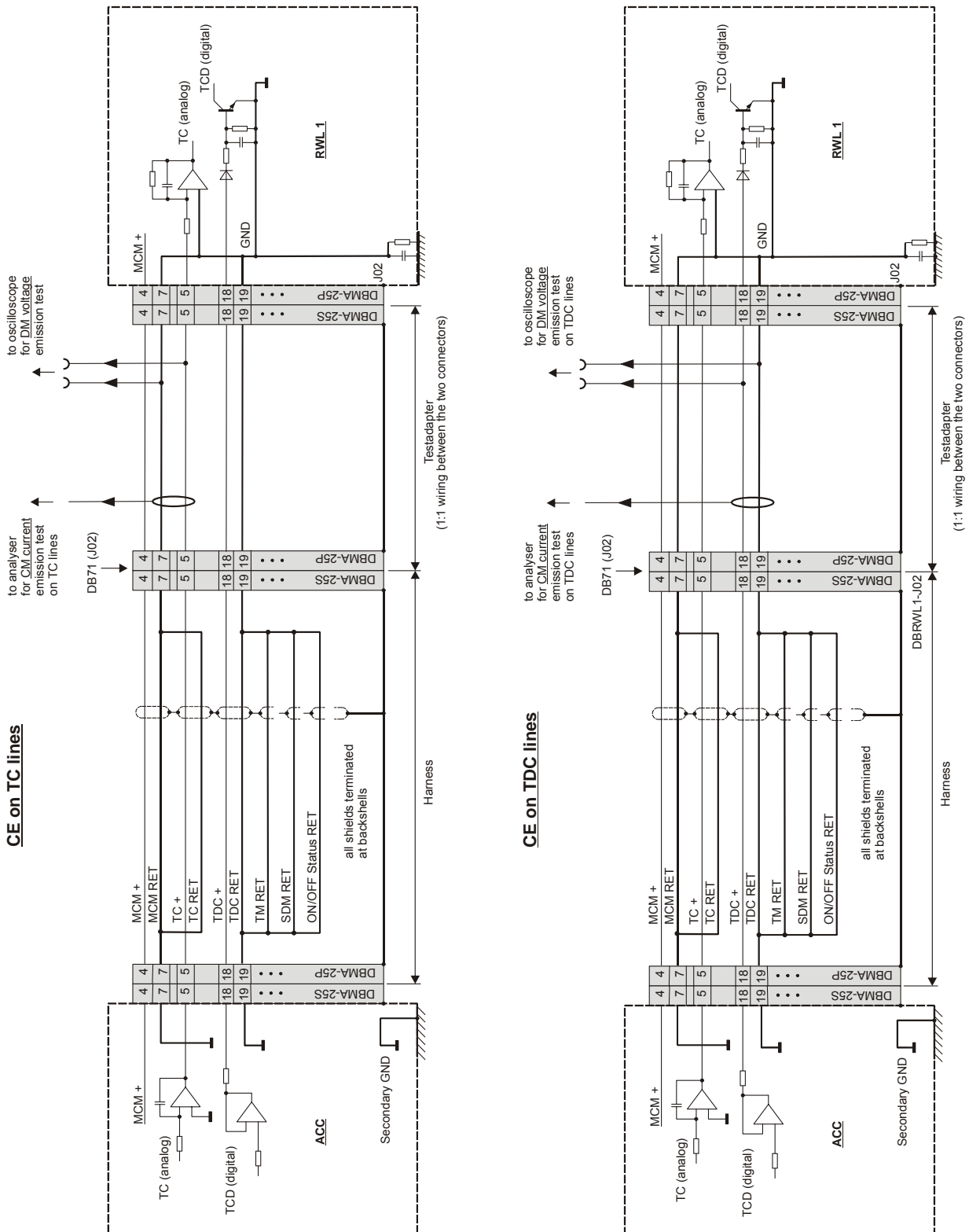


**Figure 5-2: TC Test Adapter arrangement for CE, DB02 level**

**CE on TDC lines**



**Figure 5-3: TDC Test Adapter arrangement for CE, DB02 level**



**Figure 5-4: Optional TC/TDC Test Adapter arrangement for CE, DB 71 level**

## 5.5 CE Voltage on Signal Lines

### ACC-RWL signal lines TC and TDC:

Objective of this test is to check that the conducted voltage emissions on ACC-RWL signal lines TC and TDC are within the values measured at sub system level. This test is performed to fulfil EMC requirement EMCSYS-096 of HERSCHEL EMC Specification [AD6].

The following signal lines shall be tested:

- Torque Command (TC)
- Torque Direction (TDC)

During the emission test on RWL signal lines:

- the TC command shall be set to "500" leading to a read out TLM (MCM) close to 0.5105V,
- the TDC command shall be set to CLOCKWISE direction

### MILBUS:

In addition the conducted voltage emissions shall be measured on

- ACC/1553 (MILBUS)

During the emission measurements the MILBUS shall be nominal operating.

The tests shall be done in **time domain, differential mode (DM)**.

A **background measurement** with Spacecraft OFF / EGSE ON before the test shall identify any emissions generated by the support or external power equipment.

### 5.5.1 Requirements for CE Voltage Requirements on Signal Lines

TC/TDC: The voltage ripple shall be compared to 300 mVpp. The minimum bandwidth used for measurement shall be 50MHz.

MILBUS: No requirement exists. The measurement is for information only.

### 5.5.2 CE Voltage Signal Lines Test Set-Up

#### TC and TDC:

The TC and TDC signal lines shall be interrupted by a test adapter placed at DB02 level in order to get access to the lines for common mode measurement in accordance to Figure 5-2 and Figure 5-3 and paragraph 6.3.1.

As an option only the TC and TDC signal lines may be interrupted by a test adapter placed at DB71 level, see Figure 5-4 and paragraph 6.3.2.

#### MILBUS:

The MILBUS signal lines shall be interrupted by a test adapter (see paragraph 6.3.3) in order to get access to the lines for differential mode voltage measurements.

All the measurement shall be taken with an oscilloscope.

A photograph shall be taken from the set-up, showing break-out boxes, the PCDU power connectors and the test cables and the voltage probe.

## 5.6 CS Voltage on Signal Lines (optional)

### TC and TDC:

Objective of this test is to check that the ACC-RWL signal lines TC and TDC present no risk of susceptibility when submitted to the levels specified in [AD01] EMCEQ-650. This test is performed to fulfil EMC requirement EMCSYS-094 of HERSCHEL EMC Specification [AD6]

The following lines shall be tested:

- Torque Command (TC)
- Torque Direction Command (TDC)

The test shall be done in **time domain, differential mode**.

As **reference measurement** before the test the TLM values shall be monitored at RWL side without injecting any noise. During the emission test

- the TC command shall be set to "500" leading to a read out TLM (MCM) close to 0.5105V.
- the TDC command shall be set to: CLOCKWISE direction

The frequencies to be tested are listed in the step by step procedure.

### 5.6.1 Requirements for CS Voltage on Signal Lines

In the frequency range 50 kHz – 50 MHz, the injected voltage should not exceed 2 V<sub>pp</sub> either on the signal or the AGND line. In any case, even if the level of 2 V<sub>pp</sub> is not reached the imposed current has to be monitored and it **should not exceed 100 mApp** at injection point.

Monitoring of the frequency and current amplitude shall be done by use of a spectrum analyser. The 100 mApp limit applies **only** for the injected spectral frequency; amplitudes of other signal parts of the emission spectrum are not relevant.

All along the tests sequence the TLM (MCM) read out monitoring shall be recorded.

#### Success Criteria:

1. The RWL shall not exhibit any failures malfunctions or unintended responses when submitted to the injected signals.
2. The motor current TLM (MCM) shall keep inside the range +/-12.5 mV around the value without noise injection when submitted to the injected signals.

### 5.6.2 CS Signal Voltage Test Set-Up

The TC and TDC signal lines shall be interrupted by a test adapter

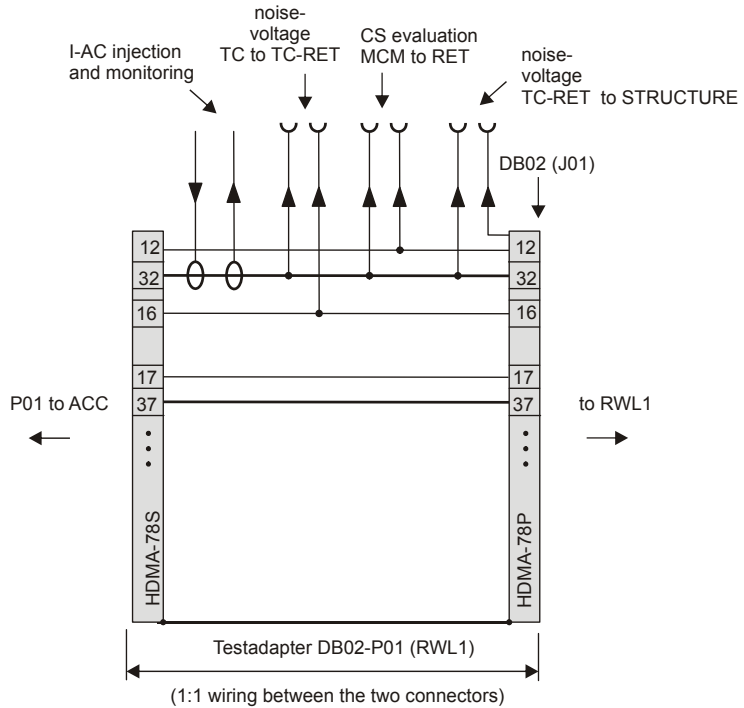
The torque command and -direction lines shall be interrupted by a test adapter placed at DB02 level in order to get access to the signal lines and to enable the injection and the time domain voltage measurements in accordance to Figure 5-5 and Figure 5-6 below and paragraph 6.3.1.

As an option only the TC and TDC signal lines may be interrupted by a test adapter placed at DB71 level near the RWL, see Figure 5-7 and paragraph 6.3.2.

A photograph shall be taken from the set-up, showing the position of the break-out box, the voltage probe and the concerned signal lines.

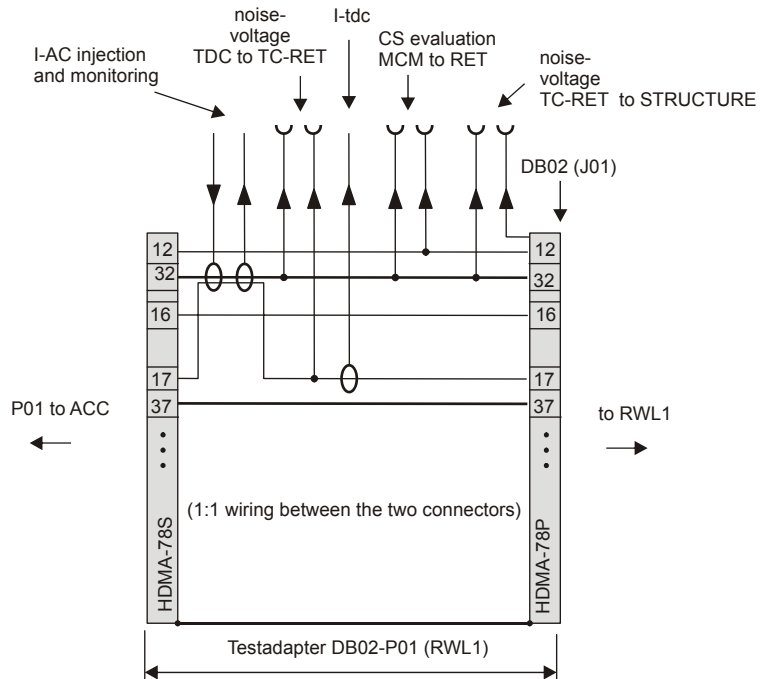


**CS on TC lines**

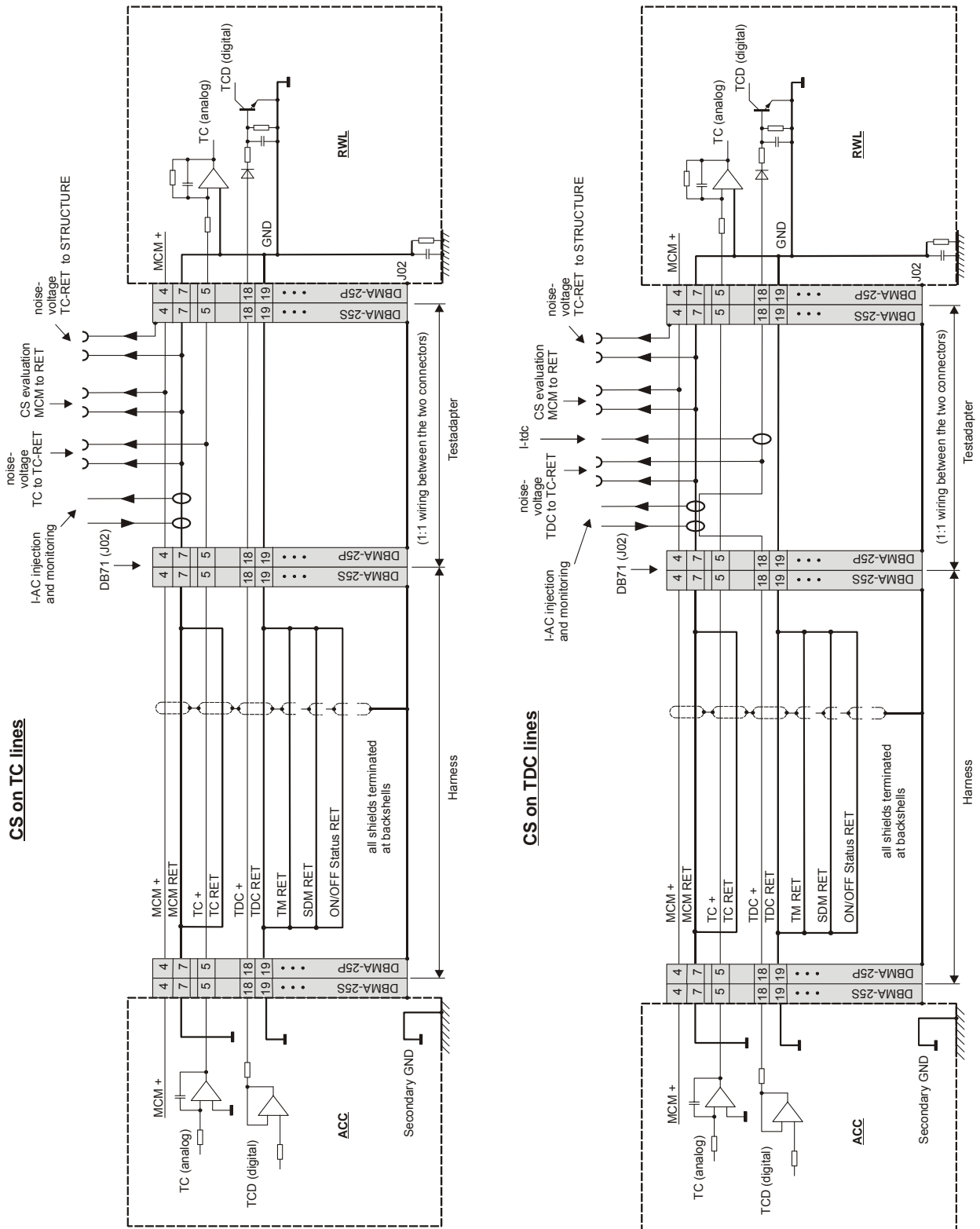


**Figure 5-5: TC Test Adapter arrangement for CS, DB02 level**

**CS on TDC lines**



**Figure 5-6: TDC Test Adapter arrangement for CS, DB02 level**

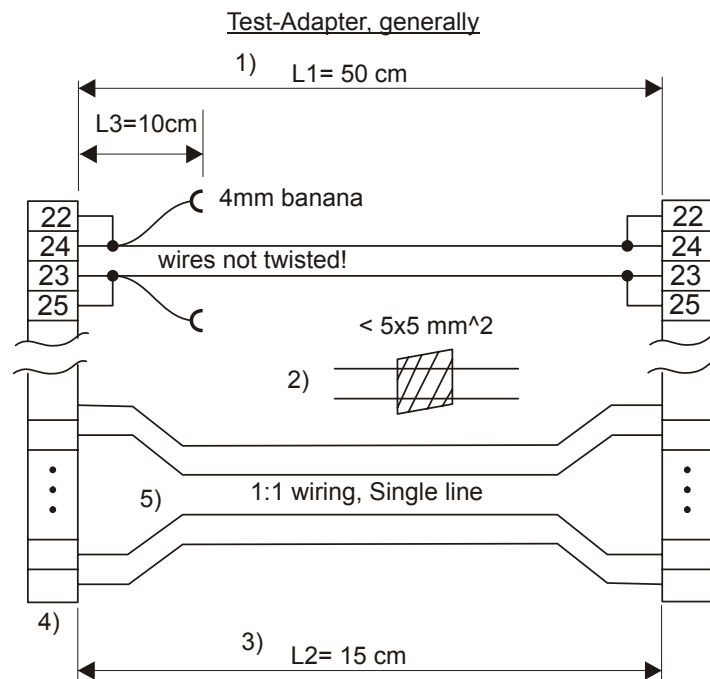


**Figure 5-7: TC/TDC Test Adapter arrangement for CS (optional, for measurements on the RWL panel)**

## 6 TEST- AID/ADAPTER ARRANGEMENTS

### 6.1 General Test- Aid/Adapter Types

General configuration for power- and signal line adapters:



**Figure 6-1: Test Adapter, General Configuration**

1)  $L1 > L2$  to avoid breaking the wire under test during differential measurements with (large) current probes (see extra sketch below). If all wires have the same length, the stress is only on the tested wire!

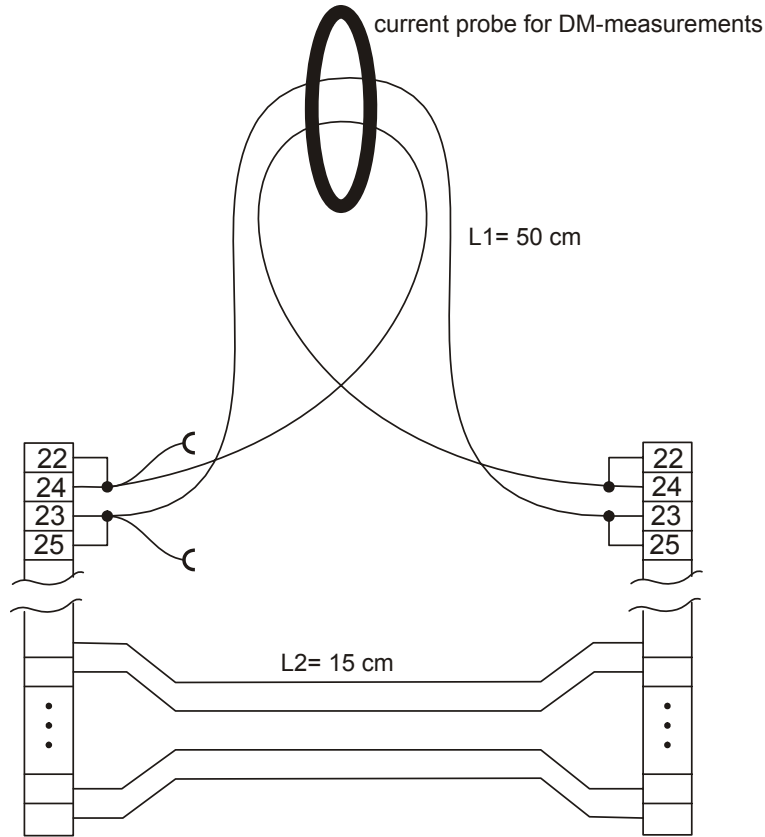
2) Maximum allowed cross-section of two wires to match for the feed through current clamp.

3)  $L3$  as short as possible/meaningfull to save place, see 1) also.

4) Material: standard wires and connectors. However connector savers shall be used in addition! Manufacturing via external supplier.

5) 1:1 single line wiring of all other pins. Twisting respecting the flight harness not necessary due to the shortness of the wires.

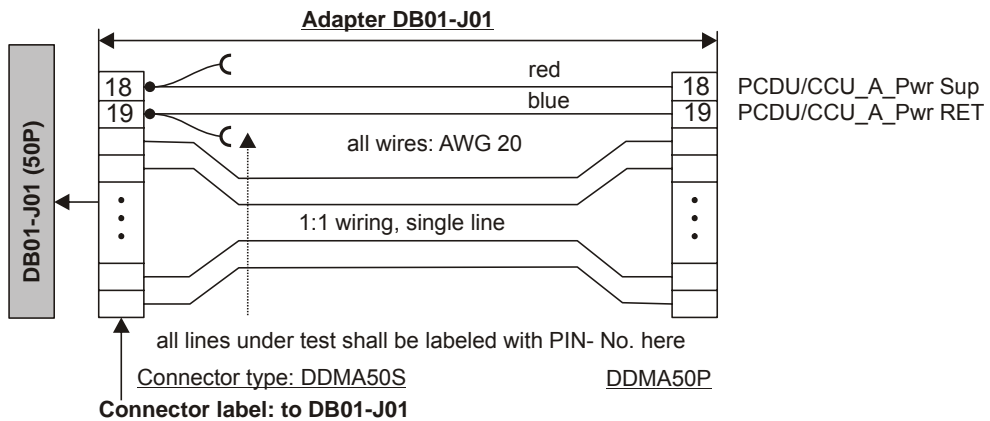
6) All wires of every adapter shall be AWG 20.



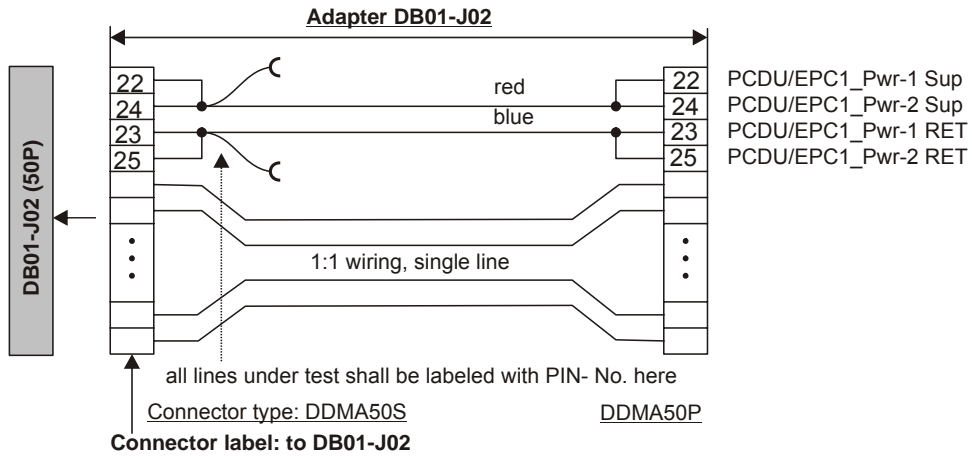
**Figure 6-2: Test Adapter, Current Probe Arrangement**

**6.1.1 Power line Test Adapters**

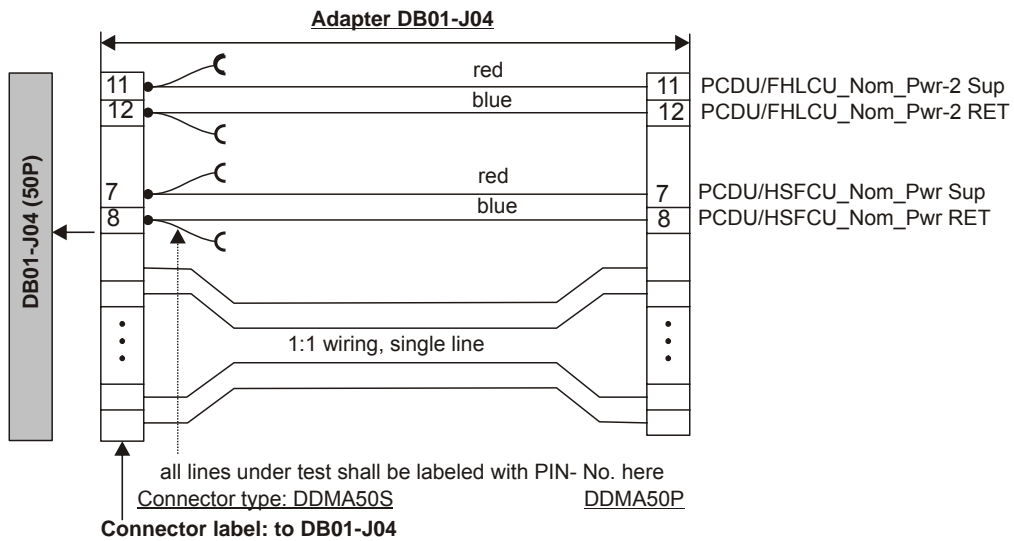
The following adapter types shall be used for testing on power lines:



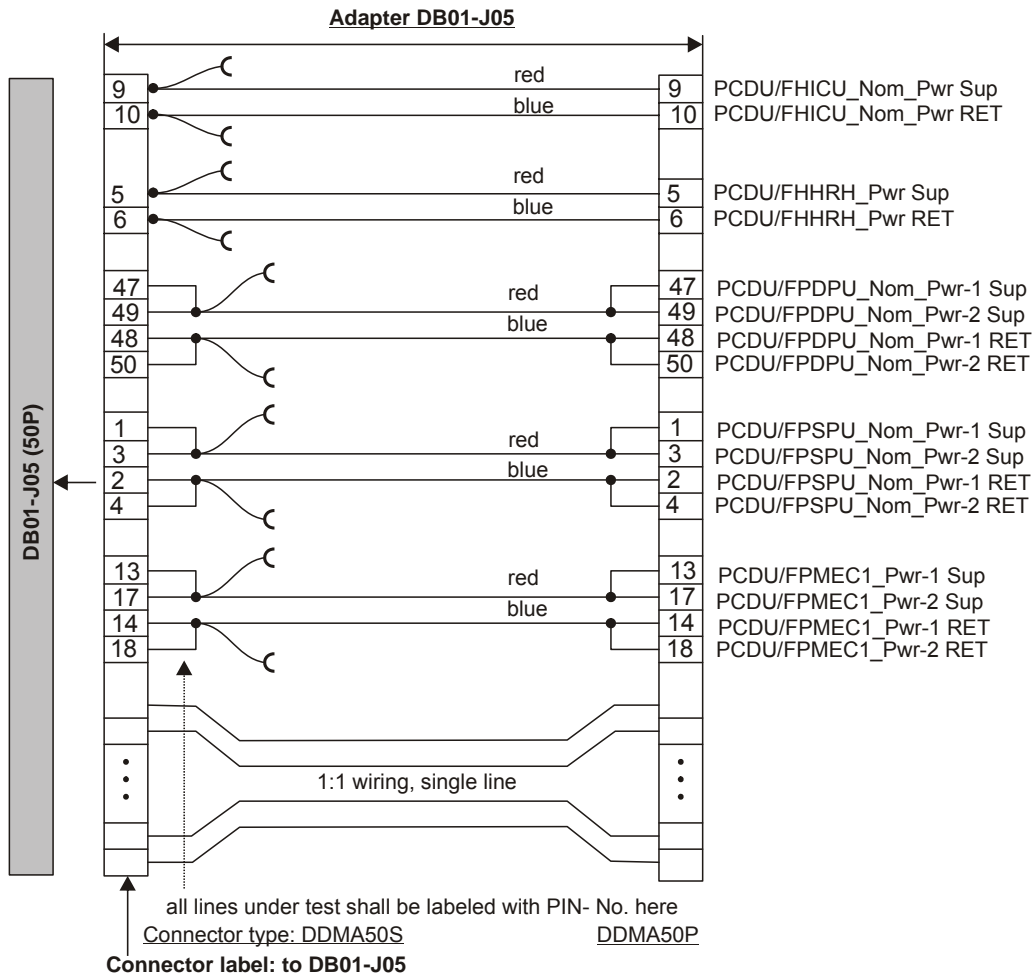
**Figure 6-3: Test Adapter DB01-J01**



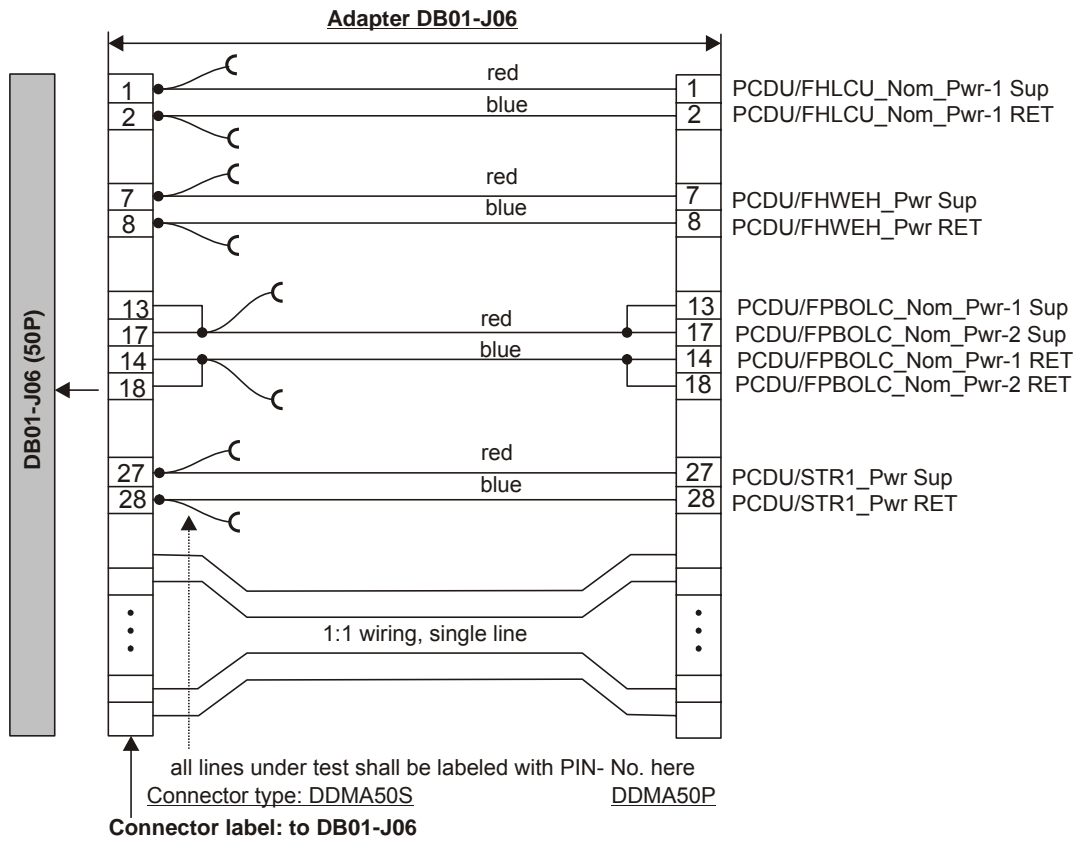
**Figure 6-4: Test Adapter DB01-J02**



**Figure 6-5: Test Adapter DB01-J04**



**Figure 6-6: Test Adapter DB01-J05**



**Figure 6-7: Test Adapter for DB01-J06**

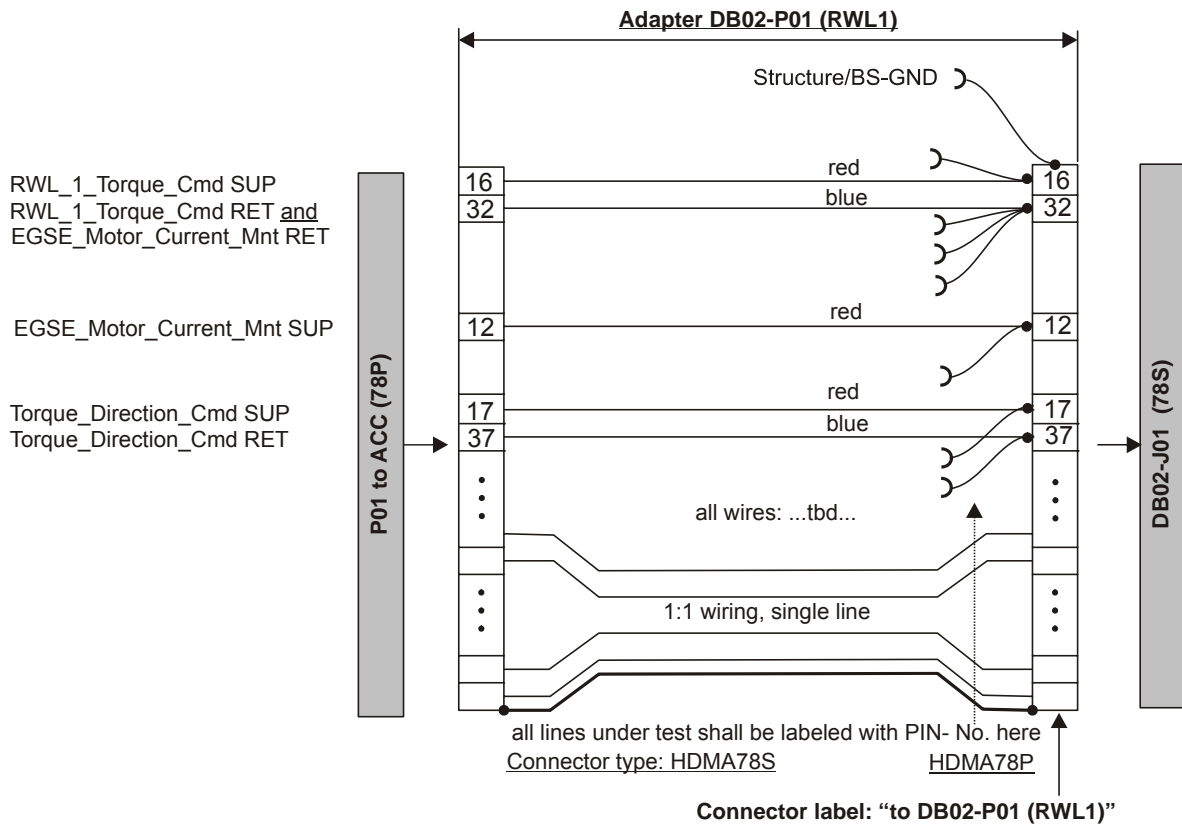
CE Voltage measurement in Time Domain, Pwr-Return to Structure:

For this measurement the voltage probe "-" shall be connected to the satellite structure.  
The access point is ...*tdb during test*...

**6.1.2 Signal line Test Adapter**

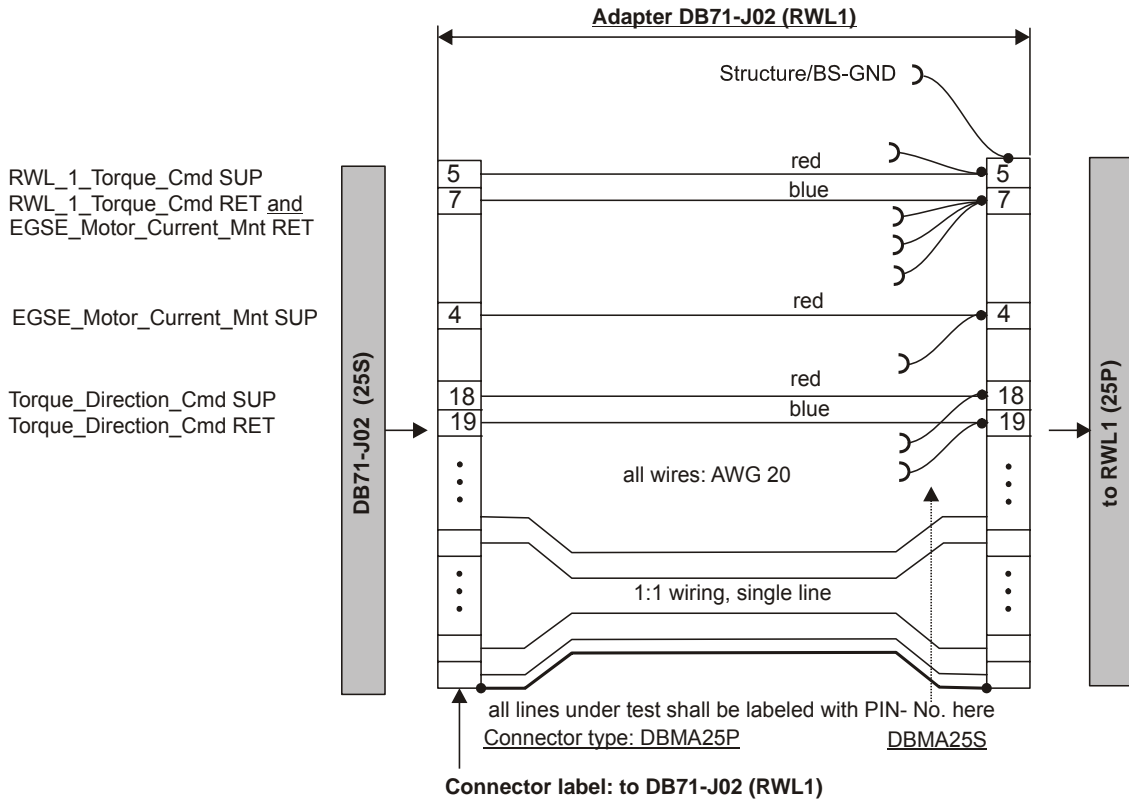
**Note that the signal lines are shielded and the shield is rooted via the connector shells.**

The following adapter type shall be used for CE/CS on TC/TDC signal lines:



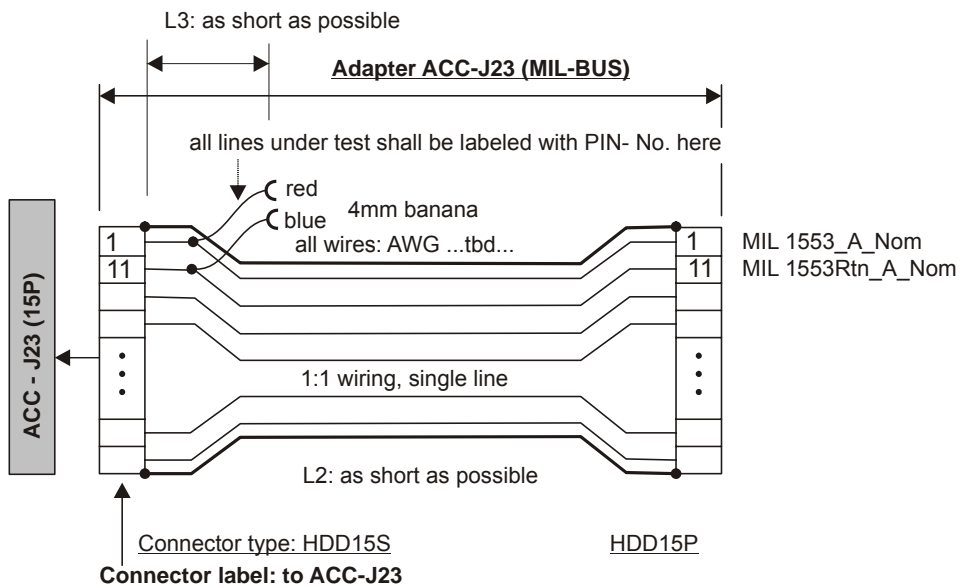
**Figure 6-8: Test adapter DB02-P01**





**Figure 6-9: Optional test adapter DB71-J02 (for RWL panel only!)**

The following adapter type shall be used for CE on MIL-BUS signal lines:



**Figure 6-10: Test adapter ACC-J23 (L3 is < 10 cm, L2 is < 5 cm)**

## 6.2 Arrangements for Power Lines

The following table shows the relation between test equipment, test adapter type and accessibility of the lines under test.

| Equipment |           | Test Adapter | Accessible per:                             |          |                          | Comment/<br>Current Cap.<br>(A) |
|-----------|-----------|--------------|---|----------|--------------------------|---------------------------------|
|           |           |              | Bracket –<br>Connector<br>(Adapter<br>Name) | Type     | Pin                      |                                 |
| HIFI      | LCU main  | Figure 6-7   | DB01 - J06                                  | DDMA-50P | PLS: 1 (*)<br>RTN: 2     | AWG 18/4                        |
| - " -     | - " -     | Figure 6-5   | DB01 – J04                                  | DDMA-50P | PLS: 11 (*)<br>RTN: 12   | AWG 18/4                        |
| - " -     | ICU main  | Figure 6-6   | DB01 - J05                                  | DDMA-50P | PLS: 9<br>RTN: 10        | AWG 20/2                        |
| SPIRE     | FCU main  | Figure 6-5   | DB01 - J04                                  | DDMA-50P | PLS: 7<br>RTN: 8         | AWG 20/4                        |
| PACS      | DPU main  | Figure 6-6   | DB01 - J05                                  | DDMA-50P | PLS: 47/49<br>RTN: 48/50 | AWG 20/2                        |
| - " -     | SPU main  | Figure 6-6   | DB01 - J05                                  | DDMA-50P | PLS: 01/03<br>RTN: 02/04 | AWG 20/1,5                      |
| CCU       | CCU main  | Figure 6-3   | DB01 - J01                                  | DDMA-50P | PLS: 18<br>RTN: 19       | AWG 20/1,5                      |
| TWTA      | EPC1      | Figure 6-4   | DB01 - J02                                  | DDMA-50P | PLS: 22/24<br>RTN: 23/25 | AWG 20/3                        |
| STR       | STR1      | Figure 6-7   | DB01 - J06                                  | DDMA-50P | PLS: 27<br>RTN: 28       | AWG 20/1                        |
| PACS      | MEC main  | Figure 6-6   | DB01 - J05                                  | DDMA-50P | PLS: 13/17<br>RTN: 14/18 | AWG 20/2                        |
| - " -     | BOLC main | Figure 6-7   | DB01 - J06                                  | DDMA-50P | PLS: 13/17<br>RTN: 14/18 | AWG 20/1,2                      |

In detail:

### HIFI-LCU-main Power Lines (\*):

- The measurement shall be done on the **PCDU/FHLCU\_Pwrs SUP/RTN** lines.
- The test aids Figure 6-7 and Figure 6-5 shall be placed at DB01 level on harness side. The connectors to be disconnected for installing the adapter are J06 and J04.
- **Attention!** The power lines to be tested are rooted in parallel via two connectors (J06 and J04). Take care to install the current probe correctly.

### HIFI-ICU main Power Lines:

- The measurement shall be done on the **PCDU/FHICU\_Nom\_Pwr SUP/RTN** lines.
- The test aid shall be placed at DB01 level on harness side. The connector to be disconnected for installing the adapter is J05.

### SPIRE-FCU main Power Lines:

- The measurement shall be done on the **PCDU/HSFCU\_Nom\_Pwr SUP/RTN** lines.
- The test aid Figure 6-5 shall be placed at DB01 level on harness side. The connector to be disconnected for installing the adapter is J04.

### PACS-DPU main Power Lines:

- The measurement shall be done on the **PCDU/FPDPU\_Nom\_Pwrs SUP/RTN** lines.
- The test aid Figure 6-6 shall be placed at DB01 level on harness side. The connector to be disconnected for installing the adapter is J05.

#### PACS-SPU main Power Lines:

- The measurement shall be done on the **PCDU/FPSPU1\_Pwrs SUP/RTN** lines.
- The test aid Figure 6-6 shall be placed at DB01 level on harness side. The connector to be disconnected for installing the adapter is J05.

#### PACS-MEC main Power Lines:

- The measurement shall be done on the **PCDU/FPMEC1\_Pwrs SUP/RTN** lines.
- The test aid Figure 6-6 shall be placed at DB01 level on harness side. The connector to be disconnected for installing the adapter is J05.

#### PACS-BOLC main Power Lines:

- The measurement shall be done on the **PCDU/FPBOLC\_Pwrs SUP/RTN** lines.
- The test aid Figure 6-7 shall be placed at DB01 level on harness side. The connector to be disconnected for installing the adapter is J06.

#### CCU main Power Lines:

- The measurement shall be done on the **PCDU/CCU\_A\_Pwrs SUP/RTN** lines.
- The test aid Figure 6-3 shall be placed at DB01 level on harness side. The connector to be disconnected for installing the adapter is J01.

#### TWTA-EPC1 Power Lines:

- The measurement shall be done on the **PCDU/EPC1\_Pwrs SUP/RTN** lines.
- The test aid Figure 6-4 shall be placed at DB01 level on harness side. The connector to be disconnected for installing the adapter is J02.

#### STR1 Power Lines:

- The measurement shall be done on the **PCDU/STR1\_Pwr SUP/RTN** lines.
- The test aid Figure 6-7 shall be placed at DB01 level on harness side. The connector to be disconnected for installing the adapter is J06.

## 6.3 Arrangements for Signal Lines

The following shows the test adapter arrangement, test adapter type and accessibility of the lines under test.

### 6.3.1 *RWL adapter arrangement for measuring on DB02 Bracket*

- The test aid Figure 6-8 shall be placed at DB02 level. The connector to be disconnected for installing the adapter is DB02-J01.
- The conducted emission measurement (CE testing) shall be done on the **Torque\_Cmd SUP/RET (16+32)** and **Torque\_Direction\_Cmd SUP/RET (17+32)** lines (see also Figure 5-2 and Figure 5-3).
- The conducted susceptibility test (CS testing) shall be done on the **MCM/TC\_RET (32)** line for the TC-interface (see also Figure 5-5).
- The conducted susceptibility test (CS testing) shall be done on the **MCM/TC\_RET (32) and TDC + (17)** lines for the TDC- interface (see also Figure 5-6).

### 6.3.2 **Optional RWL adapter arrangement for measuring on DB71 Bracket (RWL panel)**

- The test aid Figure 6-9 (see also Figure 5-4) shall be placed at DB71 level. The connector to be disconnected for installing the adapter is DB71-J02.
- The conducted emission measurement (CE testing) shall be done on the **Torque\_Cmd SUP/RET (5+7)** and **Torque\_Direction\_Cmd SUP/RET (18+19)** lines.
- The conducted susceptibility test (CS testing) shall be done on the **MCM/TC\_RET (7)** line for the TC-interface.
- The conducted susceptibility test (CS testing) shall be done on the **MCM/TC\_RET (7) and TDC + (18)** lines for the TDC- interface.

### 6.3.3 **MILBUS adapter arrangement for measuring on ACC level**

- The test aid Figure 6-10 shall be placed at ACC level. The connector to be disconnected for installing the adapter is ACC-J23.
- The conducted emission measurement (CE testing) shall be done differentially between the **MIL 1553\_A\_Nom (1)** and **MIL 1553Rtn\_A\_Nom (11)** lines.

## 6.4 Test- Aid/Adapter locations/accessability on HERSCHEL

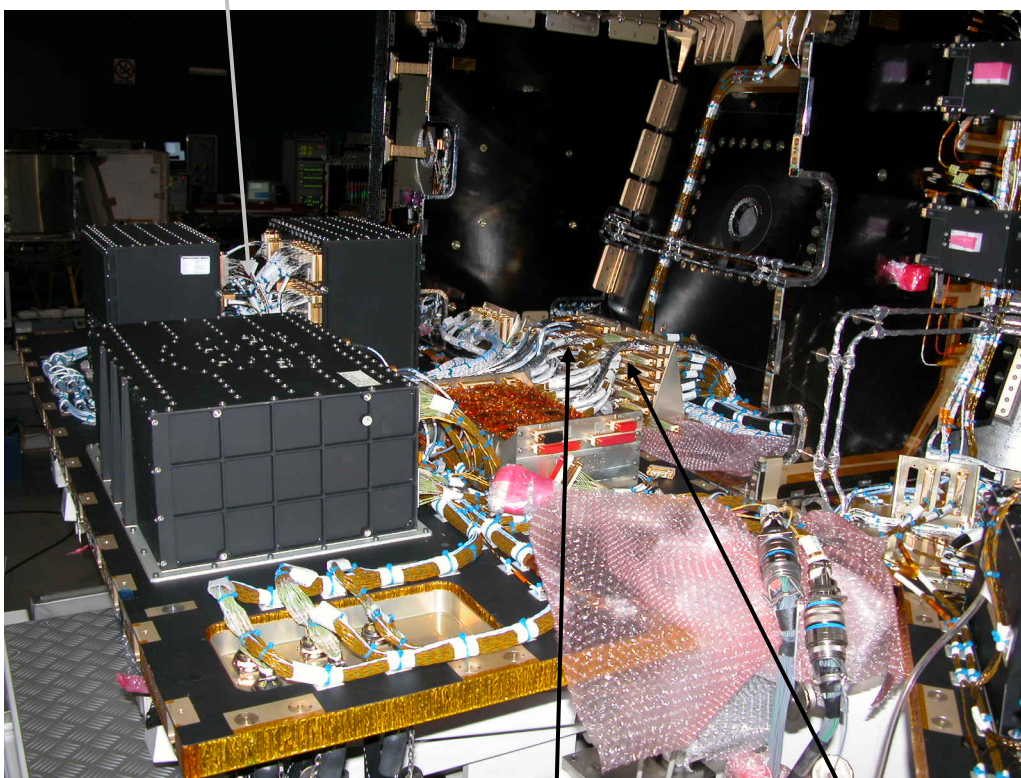
### 6.4.1 Adapter arrangement for CE tests on power- and signal lines

ACC:

Access to connector:

**J23** for CE measurements on MILBUS signal lines. Insert Test Adapter on the ACC.

Connector savers shall be used!



Bracket DB02:

Access to connector:

**J01** for CE measurements on RWL1 signal lines. Insert Test Adapter on this side of the bracket.

Connector savers shall be used!

Bracket DB01:

Access to connectors:

**J01, J02, J03, J04, J05, J06** for CE measurements on power lines.

Insert Test Adapter on this side of the bracket.

Connector type at DB01 on this side is "DyMA-xxP". So the test adapter connector type must be "DyMA-xxS".

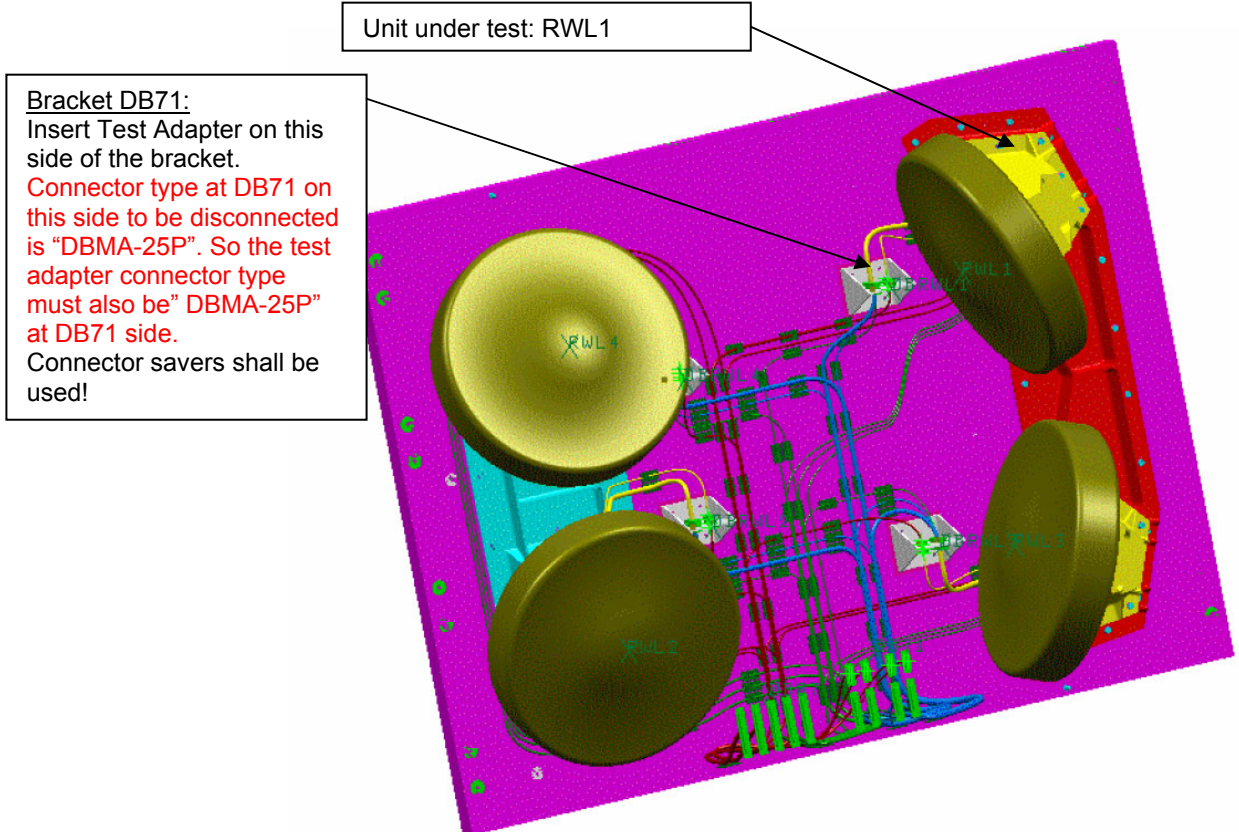
Connector savers shall be used!

### Pecautions:

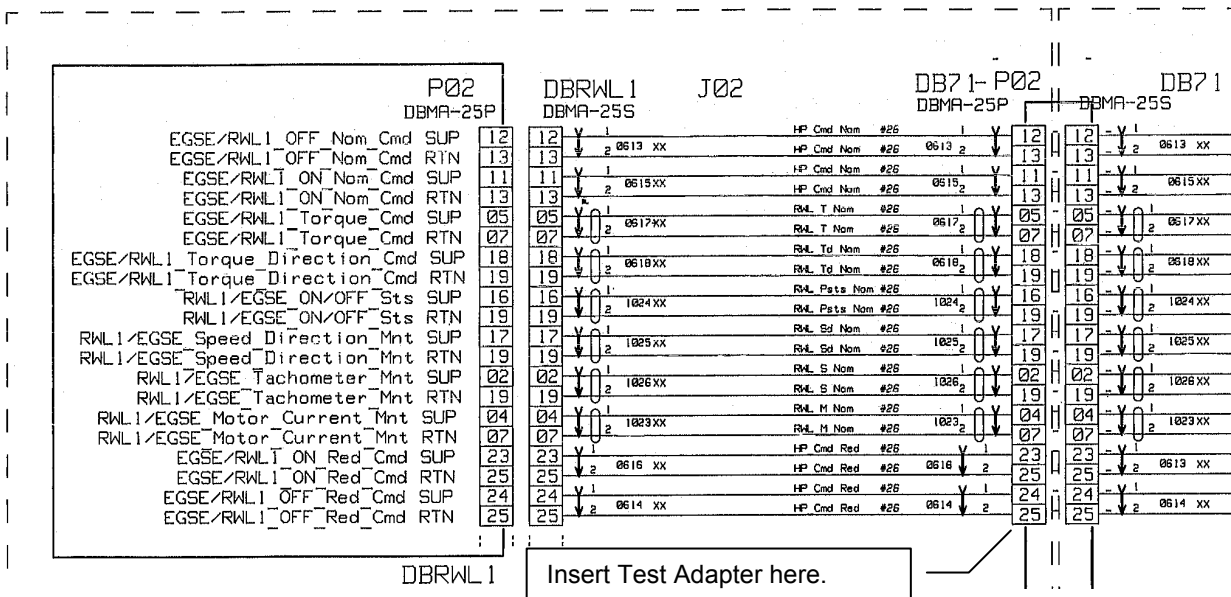
**It is absolutely mandatory to fix the EMC adapter connectors (power and signal) mechanically against disconnecting by accident or stress!**

**Note that the signal lines are shielded and the shield is rooted via the connector shells. So, when installing the EMC adapters and later performing the measurements, take care and measures that the shielding path is conductively not interrupted!**

**6.4.2 Optional adapter arrangement for CE/CS tests on signal lines**



Test adapter placement at DB71 level:



**Pecautions: See previous chapter.**

## 7 ACTIVITIES FLOW

The following tables depict the flow of the activities described in this procedure.

### 7.1 General Operational Procedures

The following table describes the general procedures to be followed followed by the SCOE operators in order to switch the satellite into the required configuration for the conducted tests.

| Test Step No/<br>Info | Description/Comments |   |
|-----------------------|----------------------|---|
| <b>A</b>              |                      | <b>REFERENCE MODE</b>   |
| A.1                   | <b>OP</b>            | Switch satellite EGSE into the REFERENCE mode Configuration according to the configuration table in chapter 3.1: perform Section 8.1.1 of <b>AD10</b> |
| A.2                   | <b>OP</b>            | Confirm that all satellite equipment is OFF (unpowered): perform Section 8.1.2 of <b>AD10</b>   |
| A.3                   | <b>OP</b>            | Confirm that HIFI, PACS and SPIRE are OFF (unpowered): perform Section 8.1.3 of <b>AD10</b>   |

| Test Step No/<br>Info | Description/Comments |  |
|-----------------------|----------------------|--|
| <b>B</b>              |                      | <b>NOISIEST MODE</b>   |
| B.1                   | <b>OP</b>            | Switch satellite EGSE into the NOISIEST mode Configuration according to the configuration table in chapter 3.1. No actions required here as performed in B.2 below |
| B.2                   | <b>OP</b>            | SVM NOISIEST mode  |
| B.2.1                 | <b>OP</b>            | Switch on into noisiest mode: perform sect. <b>8.1.1, 8.1.2, 8.1.3, 8.2.1 and 8.2.7</b> of <b>AD10</b>   |
| B.2.2                 | <b>OP</b>            | Switch PACS to <b>Safe Mode</b> perform Section 8.2.3.1 of <b>AD10</b>   |
| B.2.3                 | <b>OP</b>            | Switch SPIRE to STANDBY: perform Section 8.2.4.1 of <b>AD10</b>  |
| B.2.4                 | <b>OP</b>            | Switch HIFI to STANDBY: perform Section 8.2.5.1 of <b>AD10</b>   |
| B.2.5                 | <b>OP</b>            | Confirm that SVM & CCU equipment is operating correctly in NOISIEST mode and Instruments powered in STANDBY: perform Section 8.2.2 of <b>AD10</b>                  |
| B.3                   | <b>OP</b>            | PACS NOISIEST mode   |
| B.3.1                 |                      | If SVM OFF: perform B.2  |
| B.3.2                 | <b>OP</b>            | If SPIRE is in NOISIEST mode then return to STANDBY: perform section 8.2.4.3 of <b>AD10</b>  |
| B.3.3                 | <b>OP</b>            | If HIFI is in NOISIEST mode then return to STANDBY: perform section 8.2.5.3 of <b>AD10</b>   |
| B.3.4                 | <b>OP</b>            | PACS is in NOISIEST mode and confirm: perform section 8.2.3.2 of <b>AD10</b>   |
| B.4                   | <b>OP</b>            | HIFI NOISIEST mode   |
| B.4.1                 |                      | If SVM OFF: perform B.2  |
| B.4.2                 | <b>OP</b>            | <b>NA</b>  |
| B.4.3                 | <b>OP</b>            | If SPIRE is in NOISIEST mode then return to STANDBY: perform section 8.2.4.3 of <b>AD10</b>  |
| B.4.4                 | <b>OP</b>            | HIFI to NOISY mode and confirm: perform section 8.2.5.2 of <b>AD10</b>   |

| Test Step No/<br>Info | Description/Comments |  |
|-----------------------|----------------------|--|
| B.5                   | <b>OP</b>            | SPIRE NOISIEST mode  |
| B.5.1                 | <b>OP</b>            | If SVM OFF: perform B.2  |
| B.5.2                 | <b>OP</b>            | If HIFI is in NOISIEST mode then return to STANDBY: perform section 8.2.5.3 of <b>AD10</b> |
| B.5.3                 | <b>OP</b>            | <b>NA</b>  |
| B.5.4                 | <b>OP</b>            | SPIRE to NOISY mode and confirm: perform section 8.2.4.2 of <b>AD10</b>                    |
| B.6                   | <b>OP</b>            | RWL-1-4 noisiest mode @ 15 min : perform section 8.2.6 of <b>AD10</b>                      |
|                       |                      |  |
|                       |                      |  |

| Test Step No/<br>Info | Description/Comments |   |
|-----------------------|----------------------|---|
| <b>C</b>              |                      | <b>SENSITIVE MODE</b> (according to the configuration table in chapter 3.1)                             |
| C.1                   | <b>OP</b>            | If SATELLITE initially OFF  |
| C.1.1                 | <b>OP</b>            | Switch on into sensitive mode: perform sect. <b>8.1.1, 8.1.2, 8.1.3, 8.2.1 and 8.2.7</b> of <b>AD10</b> |
| C.2                   | <b>OP</b>            | If SATELLITE ON in NOISIEST mode  |
| C.2.1                 | <b>OP</b>            | If SPIRE is in NOISIEST mode then return to STANDBY: perform section 8.2.4.3 of <b>AD10</b>             |
| C.2.2                 | <b>OP</b>            | Switch OFF SPIRE and confirm: perform section 8.2.4.4 of <b>AD10</b>                                    |
| C.2.3                 | <b>OP</b>            | If HIFI is in NOISIEST mode then return to STANDBY: perform section 8.2.5.3 of <b>AD10</b>              |
| C.2.4                 | <b>OP</b>            | Switch OFF HIFI and confirm: perform section 8.2.5.4 of <b>AD10</b>                                     |
| C.2.5                 | <b>OP</b>            | <b>NA</b>   |
| C.2.6                 | <b>OP</b>            | Switch OFF PACS and confirm: perform section 8.2.3.4 of <b>AD10</b>                                     |
| C.2.7                 | <b>OP</b>            | Spin down reaction wheels: perform section 8.3.1 of <b>AD10</b>   |
| C.3                   | <b>OP</b>            | Confirm sensitive mode: perform section 8.3.2   |
|                       |                      |   |

| Test Step No/<br>Info | Description/Comments |  |
|-----------------------|----------------------|--|
| <b>D</b>              |                      | <b>OFF MODE</b>  |
| D.1                   | <b>OP</b>            | SPIRE OFF  |
| D.1.1                 | <b>OP</b>            | If SPIRE is in NOISIEST mode then return to STANDBY: perform section 8.2.4.3 of <b>AD10</b>      |
| D.1.2                 | <b>OP</b>            | Switch OFF SPIRE and confirm: perform section 8.2.4.4 of <b>AD10</b>                             |
|                       |                      |  |
|                       |                      |  |
| D.2                   | <b>OP</b>            | HIFI OFF   |
| D.2.1                 | <b>OP</b>            | If HIFI is in NOISIEST mode then return to STANDBY: perform section 8.2.5.3 of <b>AD10</b>       |
| D.2.2                 | <b>OP</b>            | Switch OFF HIFI and confirm: perform section 8.2.5.4 of <b>AD10</b>                              |
|                       |                      |  |
|                       |                      |  |
| D.3                   | <b>OP</b>            | PACS OFF   |
| D.3.1                 | <b>OP</b>            | <b>NA</b>  |
| D.3.2                 | <b>OP</b>            | Switch OFF PACS and confirm: perform section 8.2.3.4 of <b>AD10</b>                              |
|                       |                      |  |
|                       |                      |  |
| D.4                   | <b>OP</b>            | SVM & CCU OFF  |
| D.4.1                 | <b>OP</b>            | Switch OFF SVM: perform section 8.4.1.1 of <b>AD10</b>   |
| D.4.2                 | <b>OP</b>            | Confirm that all satellite equipment is OFF (unpowered) : perform section 8.4.1.2 of <b>AD10</b> |



| Test Step No/<br>Info | Description/Comments          |
|-----------------------|-------------------------------|
| D.5                   | <b>OP</b> Switch all EGSE OFF |

## 7.2 Tests Activities Flow

The following table depicts the flow of the activities described in this procedure.

| Test Step No | Activity  | SATELLITE Operational Mode |
|--------------|---|----------------------------|
| <b>0</b>     | <b>Install BoBs/Test Adapter to Power- and Signal Lines</b>                                       | OFF Mode                   |
| 0.1          | Test adapter "DB01-J01" for CE on CCU-MAIN  |                            |
| 0.2          | Test adapter "DB01-J02" for CE on TWTA-EPC1   |                            |
| 0.3          | Test adapter "DB01-J04" for CE on HIFI-LCU-MAIN and SPIRE-FCU-main                                |                            |
| 0.4          | Test adapter "DB01-J05" for CE on HIFI-ICU-MAIN, PACS-DPU-MAIN, PACS-SPU-MAIN and PACS-MEC1-MAIN  |                            |
| 0.5          | Test adapter "DB01-J06" for CE on HIFI-LCU-MAIN, PACS-BOLC-MAIN and STR1                          |                            |
| 0.6          | Test adapter "DB02-P01" for CE/CS on Signal Lines: RWL1 TC/TDC                                    |                            |
| 0.7          | Test adapter "ACC-J23" for CE on Signal Lines: MILBUS   |                            |
| <b>1</b>     | <b>Reference Test on Satellite Ground Line</b>  | REFERENCE Mode             |
| 1.1          | CE Current Ripple in Time Domain  |                            |
| <b>2</b>     | <b>Reference Test on HIFI-LCU-main Power Lines</b>  | REFERENCE Mode             |
| 2.1          | If not already done switch into REFERENCE Mode according to chapter 7.1 "A" and confirm the mode. |                            |
| 2.2          | CE Current in Frequency Domain Common Mode  |                            |
| 2.3          | CE Current in Frequency Domain Differential Mode  |                            |
| 2.4          | CE Current in Time Domain Differential Mode   |                            |
| 2.5          | CE Voltage in Time Domain Differential Mode   |                            |
| 2.6          | CE Voltage in Time Domain, Pwr-Return to Structure  |                            |
| <b>3</b>     | <b>Reference Test on HIFI-ICU-main Power Lines</b>  | REFERENCE Mode             |
| 3.1          | If not already done switch into REFERENCE Mode according to chapter 7.1 "A" and confirm the mode. |                            |
| 3.2          | CE Current in Frequency Domain Common Mode  |                            |
| 3.3          | CE Current in Frequency Domain Differential Mode  |                            |
| 3.4          | CE Current in Time Domain Differential Mode   |                            |
| 3.5          | CE Voltage in Time Domain Differential Mode   |                            |
| 3.6          | CE Voltage in Time Domain, Pwr-Return to Structure  |                            |
| <b>4</b>     | <b>Reference Test on SPIRE-FCU-main Power Lines</b>   | REFERENCE Mode             |
| 4.1          | If not already done switch into REFERENCE Mode according to chapter 7.1 "A" and confirm the mode. |                            |
| 4.2          | CE Current in Frequency Domain Common Mode  |                            |
| 4.3          | CE Current in Frequency Domain Differential Mode  |                            |
| 4.4          | CE Current in Time Domain Differential Mode   |                            |

| Test Step No | Activity  | SATELLITE Operational Mode |
|--------------|---|----------------------------|
| 4.5          | CE Voltage in Time Domain Differential Mode   |                            |
| 4.6          | CE Voltage in Time Domain, Pwr-Return to Structure  |                            |
| <b>5</b>     | <b>Reference Test on PACS-DPU-main Power Lines</b>  | REFERENCE Mode             |
| 5.1          | If not already done switch into REFERENCE Mode according to chapter 7.1 "A" and confirm the mode. |                            |
| 5.2          | CE Current in Frequency Domain Common Mode  |                            |
| 5.3          | CE Current in Frequency Domain Differential Mode  |                            |
| 5.4          | CE Current in Time Domain Differential Mode   |                            |
| 5.5          | CE Voltage in Time Domain Differential Mode   |                            |
| 5.6          | CE Voltage in Time Domain, Pwr-Return to Structure  |                            |
| <b>6</b>     | <b>Reference Test on PACS-SPU-main Power Lines</b>  | REFERENCE Mode             |
| 6.1          | If not already done switch into REFERENCE Mode according to chapter 7.1 "A" and confirm the mode. |                            |
| 6.2          | CE Current in Frequency Domain Common Mode  |                            |
| 6.3          | CE Current in Frequency Domain Differential Mode  |                            |
| 6.4          | CE Current in Time Domain Differential Mode   |                            |
| 6.5          | CE Voltage in Time Domain Differential Mode   |                            |
| 6.6          | CE Voltage in Time Domain, Pwr-Return to Structure  |                            |
| <b>7</b>     | <b>Reference Test on PACS-BOLC-main Power Lines</b>   | REFERENCE Mode             |
| 7.1          | If not already done switch into REFERENCE Mode according to chapter 7.1 "A" and confirm the mode. |                            |
| 7.2          | CE Current in Frequency Domain Common Mode  |                            |
| 7.3          | CE Current in Frequency Domain Differential Mode  |                            |
| 7.4          | CE Current in Time Domain Differential Mode   |                            |
| 7.5          | CE Voltage in Time Domain Differential Mode   |                            |
| 7.6          | CE Voltage in Time Domain, Pwr-Return to Structure  |                            |
| <b>8</b>     | <b>Reference Test on PACS-MEC-main Power Lines</b>  | REFERENCE Mode             |
| 8.1          | If not already done switch into REFERENCE Mode according to chapter 7.1 "A" and confirm the mode. |                            |
| 8.2          | CE Current in Frequency Domain Common Mode  |                            |
| 8.3          | CE Current in Frequency Domain Differential Mode  |                            |
| 8.4          | CE Current in Time Domain Differential Mode   |                            |
| 8.5          | CE Voltage in Time Domain Differential Mode   |                            |
| 8.6          | CE Voltage in Time Domain, Pwr-Return to Structure  |                            |
| <b>9</b>     | <b>Reference Test on CCU-main Power Lines</b>   | REFERENCE Mode             |
| 9.1          | If not already done switch into REFERENCE Mode according to chapter 7.1 "A" and confirm the mode. |                            |
| 9.2          | CE Current in Frequency Domain Common Mode  |                            |
| 9.3          | CE Current in Frequency Domain Differential Mode  |                            |
| 9.4          | CE Current in Time Domain Differential Mode   |                            |
| 9.5          | CE Voltage in Time Domain Differential Mode   |                            |
| 9.6          | CE Voltage in Time Domain, Pwr-Return to Structure  |                            |

| Test Step No | Activity  | SATELLITE Operational Mode   |
|--------------|---|--|
| <b>10</b>    | <b>Reference Test on TWTA-EPC1 Power Lines</b>  |  |
| 10.1         | If not already done switch into REFERENCE Mode according to chapter 7.1 "A" and confirm the mode. |  |
| 10.2         | CE Current in Frequency Domain Common Mode  |  |
| 10.3         | CE Current in Frequency Domain Differential Mode  |  |
| 10.4         | CE Current in Time Domain Differential Mode   |  |
| 10.5         | CE Voltage in Time Domain Differential Mode   |  |
| 10.6         | CE Voltage in Time Domain, Pwr-Return to Structure  |  |
| <b>11</b>    | <b>Reference Test on STR1 Power Lines</b>   | REFERENCE mode   |
| 11.1         | If not already done switch into REFERENCE Mode according to chapter 7.1 "A" and confirm the mode. |  |
| 11.2         | CE Current in Frequency Domain Common Mode  |  |
| 11.3         | CE Current in Frequency Domain Differential Mode  |  |
| 11.4         | CE Current in Time Domain Differential Mode   |  |
| 11.5         | CE Voltage in Time Domain Differential Mode   |  |
| 11.6         | CE Voltage in Time Domain, Pwr-Return to Structure  |  |
| <b>12</b>    | <b>Reference Test on TC Signal Lines (RWL1)</b>   | REFERENCE Mode   |
| 12.1         | If not already done switch into REFERENCE Mode according to chapter 7.1 "A" and confirm the mode. |  |
| 12.2         | CE Current in Frequency Domain Common Mode  |  |
| 12.3         | CE Voltage in Time Domain Common Mode   |  |
| <b>13</b>    | <b>Reference Test on TDC Signal Lines (RWL1)</b>  | REFERENCE Mode   |
| 13.1         | If not already done switch into REFERENCE Mode according to chapter 7.1 "A" and confirm the mode. |  |
| 13.2         | CE Current in Frequency Domain Common Mode  |  |
| 13.3         | CE Voltage in Time Domain Common Mode   |  |
| <b>14</b>    | <b>Reference Test on ACC/1553 (MILBUS) Signal Lines</b>   | REFERENCE Mode   |
| 14.1         | If not already done switch into REFERENCE Mode according to chapter 7.1 "A" and confirm the mode. |  |
| 14.2         | CE Voltage in Time Domain Differential Mode   |  |
| <b>15</b>    | <b>Reference Test on Satellite Ground Line DELETED</b>  |  |
| 15.1         | CE Current Ripple in Time Domain  |  |
| <b>16</b>    | <b>Test on HIFI-LCU-main Power Lines</b>  | NOISIEST Mode with <b>HIFI in SCIENCE</b> , <b>PACS in Safe Mode</b> and SPIRE in STANDBY: " <b>B4</b> " |
| 16.1         | If not already done switch into NOISIEST mode according to chapter 7.1 "B4" and confirm the mode  |  |
| 16.2         | CE Current in Frequency Domain Common Mode  |  |
| 16.3         | CE Current in Frequency Domain Differential Mode  |  |
| 16.4         | CE Current in Time Domain Differential Mode   |  |
| 16.5         | CE Voltage in Time Domain Differential Mode   |  |
| 16.6         | CE Voltage in Time Domain, Pwr-Return to Structure  |  |

| Test Step No | Activity   | SATELLITE Operational Mode  |
|--------------|--|---|
| <b>17</b>    | <b>Test on HIFI-ICU-main Power Lines</b>   | NOISIEST Mode with <b>HIFI in SCIENCE PACS in Safe Mode</b> and SPIRE in STANDBY: " <b>B4</b> " |
| 17.1         | If not already done switch into NOISIEST mode according to chapter 7.1 "B4" and confirm the mode |   |
| 17.2         | CE Current in Frequency Domain Common Mode   |   |
| 17.3         | CE Current in Frequency Domain Differential Mode   |   |
| 17.4         | CE Current in Time Domain Differential Mode  |   |
| 17.5         | CE Voltage in Time Domain Differential Mode  |   |
| 17.6         | CE Voltage in Time Domain, Pwr-Return to Structure   |   |
| <b>18</b>    | <b>Test on SPIRE-FCU-main Power Lines</b>  | NOISIEST Mode with <b>SPIRE in SCIENCE PACS in Safe Mode</b> and HIFI in STANDBY: " <b>B5</b> " |
| 18.1         | If not already done switch into NOISIEST mode according to chapter 7.1 "B5" and confirm the mode |   |
| 18.2         | CE Current in Frequency Domain Common Mode   |   |
| 18.3         | CE Current in Frequency Domain Differential Mode   |   |
| 18.4         | CE Current in Time Domain Differential Mode  |   |
| 18.5         | CE Voltage in Time Domain Differential Mode  |   |
| 18.6         | CE Voltage in Time Domain, Pwr-Return to Structure   |   |
| <b>19</b>    | <b>Test on PACS-DPU-main Power Lines</b>   | NOISIEST Mode with <b>PACS in Safe Mode</b> and HIFI and SPIRE in STANDBY: " <b>B3</b> "        |
| 19.1         | If not already done switch into NOISIEST mode according to chapter 7.1 "B3" and confirm the mode |   |
| 19.2         | CE Current in Frequency Domain Common Mode   |   |
| 19.3         | CE Current in Frequency Domain Differential Mode   |   |
| 19.4         | CE Current in Time Domain Differential Mode  |   |
| 19.5         | CE Voltage in Time Domain Differential Mode  |   |
| 19.5         | CE Voltage in Time Domain, Pwr-Return to Structure   |   |
| <b>20</b>    | <b>Test on PACS-SPU-main Power Lines</b>   | NOISIEST Mode with <b>PACS in Safe Mode</b> and HIFI and SPIRE in STANDBY: " <b>B3</b> "        |
| 20.1         | If not already done switch into NOISIEST mode according to chapter 7.1 "B3" and confirm the mode |   |
| 20.2         | CE Current in Frequency Domain Common Mode   |   |
| 20.3         | CE Current in Frequency Domain Differential Mode   |   |
| 20.4         | CE Current in Time Domain Differential Mode  |   |
| 20.5         | CE Voltage in Time Domain Differential Mode  |   |
| 20.6         | CE Voltage in Time Domain, Pwr-Return to Structure   |   |
| <b>21</b>    | <b>Test on PACS-BOLC-main Power Lines</b>  | NOISIEST Mode with <b>PACS in Safe Mode</b> and HIFI and SPIRE in STANDBY: " <b>B3</b> "        |
| 21.1         | If not already done switch into NOISIEST mode according to chapter 7.1 "B3" and confirm the mode |   |

| Test Step No | Activity   | SATELLITE Operational Mode  |
|--------------|--|---|
| 21.2         | CE Current in Frequency Domain Common Mode   |   |
| 21.3         | CE Current in Frequency Domain Differential Mode   |   |
| 21.4         | CE Current in Time Domain Differential Mode  |   |
| 21.5         | CE Voltage in Time Domain Differential Mode  |   |
| 21.6         | CE Voltage in Time Domain, Pwr-Return to Structure   |   |
| <b>22</b>    | <b>Test on PACS-MEC-main Power Lines</b>   | NOISIEST Mode with <b>PACS in Safe Mode</b> and HIFI and SPIRE in STANDBY: "B3"         |
| 22.1         | If not already done switch into NOISIEST mode according to chapter 7.1 "B3" and confirm the mode |   |
| 22.2         | CE Current in Frequency Domain Common Mode   |   |
| 22.3         | CE Current in Frequency Domain Differential Mode   |   |
| 22.4         | CE Current in Time Domain Differential Mode  |   |
| 22.5         | CE Voltage in Time Domain Differential Mode  |   |
| 22.6         | CE Voltage in Time Domain, Pwr-Return to Structure   |   |
| <b>23</b>    | <b>Test on CCU-main Power Lines</b>  | NOISIEST Mode with <b>HIFI in SCIENCE, PACS in Safe Mode</b> and SPIRE in STANDBY: "B4" |
| 23.1         | If not already done switch into NOISIEST mode according to chapter 7.1 "B4" and confirm the mode |   |
| 23.2         | CE Current in Frequency Domain Common Mode   |   |
| 23.3         | CE Current in Frequency Domain Differential Mode   |   |
| 23.4         | CE Current in Time Domain Differential Mode  |   |
| 23.5         | CE Voltage in Time Domain Differential Mode  |   |
| 23.6         | CE Voltage in Time Domain, Pwr-Return to Structure   |   |
| <b>24</b>    | <b>Test on TWTA-EPC1 Power Lines</b>   | NOISIEST Mode with <b>HIFI in SCIENCE, PACS in Safe Mode</b> and SPIRE in STANDBY: "B4" |
| 24.1         | If not already done switch into NOISIEST mode according to chapter 7.1 "B4" and confirm the mode |   |
| 24.2         | CE Current in Frequency Domain Common Mode   |   |
| 24.3         | CE Current in Frequency Domain Differential Mode   |   |
| 24.4         | CE Current in Time Domain Differential Mode  |   |
| 24.5         | CE Voltage in Time Domain Differential Mode  |   |
| 24.6         | CE Voltage in Time Domain, Pwr-Return to Structure   |   |
| <b>25</b>    | <b>Test on STR1 Power Lines</b>  | NOISIEST Mode with <b>HIFI in SCIENCE, PACS in Safe Mode</b> and SPIRE in STANDBY: "B4" |
| 25.1         | If not already done switch into NOISIEST mode according to chapter 7.1 "B4" and confirm the mode |   |
| 25.2         | CE Current in Frequency Domain Common Mode   |   |
| 25.3         | CE Current in Frequency Domain Differential Mode   |   |
| 25.4         | CE Current in Time Domain Differential Mode  |   |
| 25.5         | CE Voltage in Time Domain Differential Mode  |   |
| 25.6         | CE Voltage in Time Domain, Pwr-Return to Structure   |   |

| Test Step No | Activity  | SATELLITE Operational Mode   |
|--------------|---|--|
| <b>26</b>    | <b>Reference Test on Satellite Ground Line DELETED</b>  |  |
| 26.1         | CE Current Ripple in Time Domain  |  |
| <b>27</b>    | <b>CE Test on TC Signal Lines (RWL1)</b>  | NOISIEST Mode with <b>HIFI in SCIENCE, PACS in Safe Mode</b> and SPIRE in STANDBY: <b>"B4"</b> |
| 27.1         | If not already done switch into NOISIEST mode according to chapter 7.1 "B4" and confirm the mode  |  |
| 27.2         | CE Current in Frequency Domain Common Mode  |  |
| 27.3         | CE Voltage in Time Domain Common Mode   |  |
| <b>28</b>    | <b>CE Test on TDC Signal Lines (RWL1)</b>   | NOISIEST Mode with <b>HIFI in SCIENCE, PACS in Safe Mode</b> and SPIRE in STANDBY: <b>"B4"</b> |
| 28.1         | If not already done switch into NOISIEST mode according to chapter 7.1 "B4" and confirm the mode  |  |
| 28.2         | CE Current in Frequency Domain Common Mode  |  |
| 28.3         | CE Voltage in Time Domain Common Mode   |  |
| <b>29</b>    | <b>CE Test on ACC/1553 (MILBUS) Signal Lines</b>  | NOISIEST Mode with <b>HIFI in SCIENCE, PACS in Safe Mode</b> and SPIRE in STANDBY: <b>"B4"</b> |
| 29.1         | If not already done switch into NOISIEST Mode according to chapter 7.1 "B4" and confirm the mode. |  |
| 29.2         | CE Voltage in Time Domain Differential Mode   |  |
| <b>30</b>    | <b>CS Test on TC Signal Lines (RWL1)</b>  | SENSITIVE Mode (to be performed only in case of NC on CE test): <b>"C"</b>                     |
| 30.1         | If not already done switch into SENSITIVE mode according to chapter 7.1 "C" and confirm the mode  |  |
| 30.2         | Arrangement of the test equipment   |  |
| 30.3         | Reference Measurements  |  |
| 30.4         | CS testing  |  |
| 30.5         | Susceptibility evaluation   |  |
| <b>31</b>    | <b>CS Test on TDC Signal Lines (RWL1)</b>   | SENSITIVE Mode (to be performed only in case of NC on CE test): <b>"C"</b>                     |
| 31.1         | If not already done switch into SENSITIVE mode according to chapter 7.1 "C" and confirm the mode  |  |
| 31.2         | Arrangement of the test equipment   |  |
| 31.3         | Reference Measurements  |  |
| 31.4         | CS testing  |  |
| 31.5         | Susceptibility evaluation   |  |
| <b>32</b>    | <b>De-install BoBs/Test adapters</b>  | OFF Mode   |
|              | See also step No. 1   |  |




**Table 7-1: Test Activities Flow**

## 8 STEP BY STEP PROCEDURE/REPORT

The step by step procedure table shall be filled in during the test to be the basis for the test report. Unless otherwise noted, the test activities shall be performed by the EMC team.








If helpful the following editorial aids may be inserted into the procedure table by "copy and paste":

- "Done" sign
- Pass** "Pass" status for meeting a requirement
- Fail** "Fail" status for not meeting a requirement
- OP Executant: Satellite /EGSE and operational responsables
- EMC Executant: EMC responsible








|   |  |
|---|--|
|    | Table row for <b>comments</b> , if any   |
|    | Table row for <b>photos</b> , when taken |
|  | Table row for <b>plots</b> , when taken  |

### 8.1 Installation of Test Adapters to Power- and Signal Lines

| Test Step No/<br>Info | Description/Comments   |
|-----------------------|--|
| <b>0</b>              | <p><b>INSTALL TEST ADAPTER ON POWER- AND SIGNAL LINES LINES</b></p> <p>In additional see paragraph 6.4: Test- Aid/Adapter locations/accessability on HERSCHEL"</p> <p><b><u>Pecautions:</u></b></p> <p><b>Any open waveguides of HIFI shall be closed by copper tape or a dummy load, details on the configuration to be defined during the TRR.</b></p> <p><b>The RF antennas shall be covered by the antenna test caps or removed and the antenna ports loaded by suitable RF load in order to avoid RF transmission in command failure case.</b></p> <p><b>It is absolutely mandatory to fix the EMC adapter connectors (power and signal) mechanically against disconnecting by accident or stress!</b></p> <p><b>Note that the signal lines are shielded and the shield is rooted via the connector shells. So, when installing the EMC adapters, take care and measures that the shielding path is conductively not interrupted!</b></p> |
| <i>Date/Time</i>      |  |
| 0.1                   | <p><b>Test adapter "DB01-J01" for CE on <u>CCU-MAIN</u></b></p> <p>The test aid Figure 6-3 shall be placed at DB01 level on harness side. The connector to be</p>  |



| Test Step No/<br>Info   | Description/Comments   |
|---|--|
|   | <p>disconnected for installing the adapter is J01.</p> <p>The adaper supports measurements on the <i>PCDU/CCU_A_Pwrs SUP/RTN</i> lines.</p>  |
|    | Comments if any  |
|    | Photos:  |
|   |  |
| <i>Date/Time</i>  |  |
| 0.2   | <p><b>Test adapter "DB01-J02" for CE on <u>TWTA-EPC1</u></b></p> <p>The test aid Figure 6-4 shall be placed at DB01 level on harness side. The connector to be disconnected for installing the adapter is J02.</p> <p>The adaper supports measurements on the <i>PCDU/EPC1_Pwrs SUP/RTN</i> lines.</p>   |
|   | Comments if any  |
|  | Photos:  |
|   |  |
| <i>Date/Time</i>  |  |
| 0.3   | <p><b>Test adapter "DB01-J04" for CE on <u>HIFI-LCU-MAIN</u> and <u>SPIRE-FCU-main</u></b></p> <p>The test aids Figure 6-5 shall be placed at DB01 level on harness side. The connector to be disconnected for installing the adapter is J04.</p> <p>The adaper supports measurements on the <i>PCDU/FHLCU_Pwrs SUP/RTN</i> and <i>PCDU/HSFCU_Nom_Pwr SUP/RTN</i> lines.</p>   |
|  | Comments if any  |
|  | Photos:  |
|   |  |
| <i>Date/Time</i>  |  |
| 0.4   | <p><b>Test adapter "DB01-J05" for CE on <u>HIFI-ICU-MAIN</u>, <u>PACS-DPU-MAIN</u>, <u>PACS-SPU-MAIN</u> and <u>PACS-MEC1-MAIN</u></b></p> <p>The test aid shall be placed at DB01 level on harness side. The connector to be disconnected for installing the adapter is J05.</p> <p>The adaper supports measurements on the <i>PCDU/FHICU_Nom_Pwr SUP/RTN</i>, <i>PCDU/FPDPU_Nom_Pwrs SUP/RTN</i> and <i>PCDU/FPSPU1_Pwrs SUP/RTN</i> lines<br/><i>PCDU/FPMEC1_Pwrs SUP/RTN</i> lines</p> |
|  | Comments if any  |



| Test Step No/<br>Info   | Description/Comments   |
|---|--|
|    | Photos:  |
| <i>Date/Time</i>  |  |
| 0.5   | <b>Test adapter "DB01-J06" for CE on <u>HIFI-LCU-MAIN, PACS-BOLC-MAIN and STR1</u></b>   |
|   | <p>The test aid Figure 6-7 shall be placed at DB01 level on harness side. The connector to be disconnected for installing the adapter is J06.</p> <p>The adapter supports measurements on the<br/> <i>PCDU/FHLCU_Pwrs SUP/RTN,</i><br/> <i>PCDU/FPBOLC_Pwrs SUP/RTN and</i><br/> <i>PCDU/STR1_Pwr SUP/RTN</i> lines.</p> |
|    | <a href="#">Comments if any</a>  |
|    | Photos:  |
| <i>Date/Time</i>  |  |
| 0.6   | <b>Test adapter "DB02-P01" for CE/CS on Signal Lines: <u>RWL1 TC/TDC</u></b>   |
|   | <p>The test aid Figure 6-8 shall be placed at DB02 level. The connector to be disconnected for installing the adapter is DB02-P01.</p> <p>The adapter supports measurements on the<br/> <i>Torque_Cmd SUP/RET and</i><br/> <i>Torque_Direction_Cmd SUP/RET</i> lines.</p>  |
|  | <a href="#">Comments if any</a>  |
|  | Photos:  |
| <i>Date/Time</i>  |  |
| 0.7   | <b>Test adapter "ACC-J23" for CE on Signal Lines: <u>MILBUS</u></b>  |
|   | <p>The test aid Figure 6-10 shall be placed at ACC level. The connector to be disconnected for installing the adapter is ACC-J23.</p> <p>The adapter supports measurements on the<br/> <i>MIL1553/1553Rtn</i> lines.</p>   |
|  | <a href="#">Comments if any</a>  |
|  | Photos:  |







## 8.2 Reference/Ambient Tests on Satellite Ground Line





This test shall be performed prior to the ambient measurements on power- and signal lines.







| Test Step No., Executant  | Description/Comments   |
|---|--|
| <b>1</b>  | <b>Reference/Ambient Test on <u>Satellite Ground Line</u></b>  |
| 1.1   | <u>REFERENCE Mode</u>  |
| <b>OP</b>   | If not already done switch into REFERENCE mode according to chapter 7.1 "A" and confirm the mode   |
| <i>Date/Time</i>  |  |
|   | The measurement shall be done on the <b>Satellite Ground</b> line.<br>The ground line is accessible from underneath the power panel.<br>Take care to install the probes correctly. |
| <i>Date/Time</i>  |  |
| 1.2   | <u>CE Current in Time Domain, single line measurement</u>  |
|   | Set the current clamp on the satellite ground line for single line measurements. Measure the ambient DC current and the current ripple with an oscilloscope (BW ≥ 50 MHz).         |
|  | <b>Plot 0xx:</b><br>Measured Ambient DC current: I-DCamb = xxx mA<br>Measured current ripple : I-amb = xxx mApp  |
|  | Photos:  |
|   | Remove the current probe.  |





### 8.3 Reference/Ambient Tests on Power Lines








| Test Step No., Executant | Description/Comments  |
|--------------------------|---|
|                          | <p><b>REFERENCE/AMBIENT TEST ON POWER LINES LINES</b><br/>In additional see paragraph 6.2 "Arrangements for Power Lines".</p> <p><b>Before starting an EMC test:</b></p> <p><b>Any open waveguides of HIFI shall be closed by copper tape or a dummy load, details on the configuration to be defined during the TRR.</b></p> <p><b>The RF antennas shall be covered by the antenna test caps or removed and the antenna ports loaded by suitable RF load in order to avoid RF transmission in command failure case.</b></p> <p><b>Ckcek that all the EMC adapter connectors are mechanically secured against disconnecting by accident or stress!</b></p> <p><b>Pay special attention and take precautions when clamping and unclamping the measurement transducers (e.g. voltage- and current probes) to and from the EMC adapter wires. Wires may breake under stress.</b></p> |
| <b>2</b>                 | <b>Reference/Ambient Test on <u>HIFI-LCU-main</u> Power Lines</b>   |
| 2.1                      | <u>REFERENCE Mode</u>   |
| <b>OP</b>                | If not already done switch into REFERENCE mode according to chapter 7.1 "A" and confirm the mode.   |
|                          | On Power SCOE verify the spacecraft OFF condition:<br><br>Measured: U = _____   |
| <i>Date/Time</i>         |   |
|                          | <p>The measurement shall be done on the <b>PCDU/FHLCU_Pwrs SUP/RTN</b> lines.</p> <p>The power lines are accessible via the test adapter DB01-J06 (Figure 6-7) and DB01-J04 (Figure 6-5).</p> <p><b>Attention!</b> The power lines under test were rooted in <u>parallel</u> via the two connectors (J06 and J04).</p> <p>"plus": DB01-J06 pin 1, parallel to DB01-J04 pin 11<br/>"return": DB01-J06 pin 2, parallel to DB01-J04 pin 12</p> <p>Take care to install the probes correctly.</p>   |
| <i>Date/Time</i>         |   |
| 2.2                      | <u>CE Current in Frequency Domain, Common Mode</u>  |
|                          | Set the current clamp on the HIFI-LCU-main power lines for CM measurements in accordance to the CM set-up Figure 5-1: Schematic for CM and DM Measurements. Measure the ambient current from 30 Hz to 50 MHz.   |

| Test Step No., Executant  | Description/Comments   |
|---|--|
|    | Plot 0xx: 30 Hz – 10 kHz, CM-ambient, HIFI-LCU-main -PWR<br>Plot 0xx: 10 kHz – 1 MHz, CM-ambient, HIFI-LCU-main -PWR<br>Plot 0xx: 1 MHz – 30 MHz, CM-ambient, HIFI-LCU-main -PWR<br>Plot 0xx: 30 MHz – 50 MHz, CM-ambient, HIFI-LCU-main -PWR  |
|    | Photos:  |
|   | Remove the current probe.  |
| <i>Date/Time</i>  |  |
| 2.3   | <u>CE Current in Frequency Domain, Differential Mode</u>   |
|   | Set the current clamp on the HIFI-LCU-main power lines_for DM measurements in accordance to the DM set-up Figure 5-1: Schematic for CM and DM Measurements. Measure the ambient current from 30 Hz to 50 MHz.  |
|   | Plot 0xx: 30 Hz – 10 kHz, DM-ambient, HIFI-LCU-main -PWR<br>Plot 0xx: 10 kHz – 1 MHz, DM-ambient, HIFI-LCU-main -PWR<br>Plot 0xx: 1 MHz – 30 MHz, DM-ambient, HIFI-LCU-main -PWR<br>Plot 0xx: 30 MHz – 50 MHz, DM-ambient, HIFI-LCU-main -PWR  |
|  | Photos:  |
|   | Remove the current probe.  |
| <i>Date/Time</i>  |  |
| 2.4   | <u>CE Current in Time Domain, Differential Mode</u>  |
|   | Set the current clamp on the HIFI-LCU-main power lines_for DM measurements as before. Measure the ambient DC current and the current ripple with an oscilloscope (BW ≥ 50 MHz).  |
|  | Plot 0xx:<br>Measured Ambient DC current: I-DCamb = xxx mA<br>Measured current ripple : I-amb = xxx mApp   |
|  | Photos:  |
|   | Remove the current probe.  |
| <i>Date/Time</i>  |  |
| 2.5   | <u>CE Voltage in Time Domain Differential Mode</u>   |
|   | Set the voltage probe on the HIFI-LCU-main power lines_for DM voltage measurements and measure the differential ambient voltage ripple with an oscilloscope (BW ≥ 50 MHz) in adequate time-/amplitude scaling.<br><br>“plus”: DB01-J06 pin 1<br>“return”: DB01-J06 pin 2<br><br>and/or |




| Test Step No., Executant  | Description/Comments  |
|---|---|
|   | "plus": DB01-J04 pin 11<br>"return": DB01-J04 pin 12  |
|    | Plot 0xx:<br>Measured Ambient voltage ripple: $u\text{-amb} = xxx \text{ Vpp}$ ( $>/< 2,5 \text{ V}$ )  |
|    | Photos:   |
|   | Remove the oscilloscope connection from the test adapter.   |
| <i>Date/Time</i>  |   |
| 2.6   | <u>CE Voltage in Time Domain, Pwr-Return to Structure</u>   |
|   | Connect the differential voltage probe "+" input to the HIFI-LCU-main RETURN power line and the differential voltage probe "-" input to the satellite structure.<br><br>Measure the differential voltage ripple with an oscilloscope ( $BW \geq 50 \text{ MHz}$ ) in adequate time-/amplitude scaling.<br><br>"return": DB01-J06 pin 2<br>"satellite structure": ...tbd during test...<br><br>and/or<br><br>"return": DB01-J04 pin 12<br>"satellite structure": ...tbd during test... |
|  | Plot 0xx:<br>Measured Ambient voltage ripple: $u\text{-amb} = xxx \text{ Vpp}$  |
|  | Photos:   |
|   | Remove the oscilloscope connection from the test adapter.   |
| <b>3</b>  | <b>Reference/Ambient Test on <u>HIFI-ICU-main</u> Power Lines</b>   |
| 3.1   | <u>REFERENCE mode</u>   |
| <b>OP</b>   | If not already done switch into REFERENCE mode according to chapter 7.1 "A" and confirm the mode<br>On Power SCOE verify the spacecraft OFF condition.:<br><br>Measured: $U = \underline{\hspace{2cm}}$   |
| <i>Date/Time</i>  |   |
|   | The measurement shall be done on the <b>PCDU/FHICU_Nom_Pwr SUP/RTN</b> lines.<br><br>The power lines are accessible via the test adapter DB01-J05 (Figure 6-6).<br><br>"plus": DB01-J05 pin 9<br>"return": DB01-J05 pin 10  |



|   |   |
|---|---|
| <i>Date/Time</i>  |   |
| 3.2   | <u>CE Current in Frequency Domain, Common Mode</u>  |
|   | Set the current clamp on the HIFI-ICU-main power lines for CM measurements in accordance to the CM set-up Figure 5-1: Schematic for CM and DM Measurements. Measure the ambient current from 30 Hz to 50 MHz.   |
|    | Plot 0xx: 30 Hz – 10 kHz, CM-ambient, HIFI-ICU-main -PWR<br>Plot 0xx: 10 kHz – 1 MHz, CM-ambient, HIFI- ICU -main -PWR<br>Plot 0xx: 1 MHz – 30 MHz, CM-ambient, HIFI- ICU -main -PWR<br>Plot 0xx: 30 MHz – 50 MHz, CM-ambient, HIFI- ICU -main -PWR   |
|    | Photos:   |
|   | Remove the current probe.   |
| <i>Date/Time</i>  |   |
| 3.3   | <u>CE Current in Frequency Domain, Differential Mode</u>  |
|   | Set the current clamp on the HIFI-ICU-main power lines for DM measurements in accordance to the DM set-up Figure 5-1: Schematic for CM and DM Measurements. Measure the ambient current from 30 Hz to 50 MHz.   |
|  | Plot 0xx: 30 Hz – 10 kHz, DM-ambient, HIFI- ICU -main -PWR<br>Plot 0xx: 10 kHz – 1 MHz, DM-ambient, HIFI- ICU -main -PWR<br>Plot 0xx: 1 MHz – 30 MHz, DM-ambient, HIFI- ICU -main -PWR<br>Plot 0xx: 30 MHz – 50 MHz, DM-ambient, HIFI- ICU -main -PWR |
|  | Photos:   |
|   | Remove the current probe.   |
| <i>Date/Time</i>  |   |
| 3.4   | <u>CE Current in Time Domain, Differential Mode</u>   |
|   | Set the current clamp on the HIFI-ICU-main power lines for DM measurements as before. Measure the ambient DC current and the current ripple with an oscilloscope (BW ≥ 50 MHz).   |
|  | Plot 0xx:<br>Measured Ambient DC current: I-DCamb = xxx mA<br>Measured current ripple : I-amb = xxx mApp  |
|  | Photos:   |
|   | Remove the current probe.   |
| <i>Date/Time</i>  |   |
| 3.5   | <u>CE Voltage in Time Domain Differential Mode</u>  |
|   | Set the voltage probe on the HIFI-ICU-main power lines for DM voltage measurements and measure the differential ambient voltage ripple with an oscilloscope (BW ≥ 50 MHz) in adequate time-/amplitude scaling.  |







|   |   |
|---|---|
|   | <p>“plus”: DB01-J05 pin 9<br/>“return”: DB01-J05 pin 10</p>   |
|    | <p>Plot 0xx:<br/>Measured Ambient voltage ripple: <math>u\text{-amb} = xxx \text{ Vpp}</math> (<math>&gt;/&lt; 2,5 \text{ V}</math>)</p>  |
|    | <p>Photos:</p>  |
|   | <p>Remove the oscilloscope connection from the test adapter.</p>  |
| <p><i>Date/Time</i></p>   |   |
| 3.6   | <p><u>CE Voltage in Time Domain, Pwr-Return to Structure</u></p>  |
|   | <p>Connect the differential voltage probe "+" input to the HIFI-ICU-main RETURN power line and the differential voltage probe "-" input to the satellite structure.</p> <p>Measure the differential voltage ripple with an oscilloscope (<math>BW \geq 50 \text{ MHz}</math>) in adequate time-/amplitude scaling.</p> <p>“return”: DB01-J05 pin 10<br/>“satellite structure”: ...<i>tdb during test...</i></p> |
|  | <p>Plot 0xx:<br/>Measured Ambient voltage ripple: <math>u\text{-amb} = xxx \text{ Vpp}</math></p>   |
|  | <p>Photos:</p>  |
|   | <p>Remove the oscilloscope connection from the test adapter.</p>  |
| <b>4</b>  | <p><b>Reference/Ambient Test on <u>SPIRE-FCU-main</u> Power Lines</b></p>   |
| 4.1   | <p><u>REFERENCE Mode</u></p>  |
|   | <p><b>OP</b> If not already done switch into REFERENCE mode according to chapter 7.1 “A” and confirm the mode</p>   |
|   | <p>On Power SCOE verify the spacecraft OFF condition:</p> <p>Measured: <math>U = \underline{\hspace{2cm}}</math></p>  |
| <p><i>Date/Time</i></p>   |   |
|   | <p>The measurement shall be done on the <b>PCDU/HSFCU_Nom_Pwr SUP/RTN</b> lines.</p> <p>The power lines are accessible via the test adapter DB01-J04 (Figure 6-5).</p> <p>“plus”: DB01-J04 pin 7<br/>“return”: DB01-J04 pin 8</p>   |
| <p><i>Date/Time</i></p>   |   |
| 4.2   | <p><u>CE Current in Frequency Domain, Common Mode</u></p>   |
|   | <p>Set the current clamp on the SPIRE-FCU-main power lines for CM measurements in accordance to the CM set-up Figure 5-1: Schematic for CM and DM Measurements. Measure the ambient current from 30 Hz to 50 MHz.</p>   |



|   |   |
|---|---|
|    | Plot 0xx: 30 Hz – 10 kHz, CM-ambient, SPIRE-FCU -main -PWR<br>Plot 0xx: 10 kHz – 1 MHz, CM-ambient, SPIRE-FCU -main -PWR<br>Plot 0xx: 1 MHz – 30 MHz, CM-ambient, SPIRE-FCU -main -PWR<br>Plot 0xx: 30 MHz – 50 MHz, CM-ambient, SPIRE-FCU -main -PWR                     |
|    | Photos:   |
|   | Remove the current probe.   |
| <i>Date/Time</i>  |   |
| 4.3   | <u>CE Current in Frequency Domain, Differential Mode</u>  |
|   | Set the current clamp on the SPIRE-FCU -main power lines_for DM measurements in accordance to the DM set-up Figure 5-1: Schematic for CM and DM Measurements. Measure the ambient current from 30 Hz to 50 MHz.   |
|    | Plot 0xx: 30 Hz – 10 kHz, DM-ambient, SPIRE-FCU -main -PWR<br>Plot 0xx: 10 kHz – 1 MHz, DM-ambient, SPIRE-FCU -main -PWR<br>Plot 0xx: 1 MHz – 30 MHz, DM-ambient, SPIRE-FCU -main -PWR<br>Plot 0xx: 30 MHz – 50 MHz, DM-ambient, SPIRE-FCU -main -PWR                     |
|  | Photos:   |
|   | Remove the current probe.   |
| <i>Date/Time</i>  |   |
| 4.4   | <u>CE Current in Time Domain, Differential Mode</u>   |
|   | Set the current clamp on the SPIRE-FCU -main power lines_for DM measurements as before. Measure the ambient DC current and the current ripple with an oscilloscope (BW ≥ 50 MHz).   |
|  | Plot 0xx:<br>Measured Ambient DC current: I-DCamb = xxx mA<br>Measured current ripple : I-amb = xxx mApp  |
|  | Photos:   |
|   | Remove the current probe.   |
| <i>Date/Time</i>  |   |
| 4.5   | <u>CE Voltage in Time Domain Differential Mode</u>  |
|   | Set the voltage probe on the SPIRE-FCU-main power lines_for DM voltage measurements and measure the differential ambient voltage ripple with an oscilloscope (BW ≥ 50 MHz) in adequate time-/amplitude scaling.<br><br>“plus”: DB01-J04 pin 7<br>“return”: DB01-J04 pin 8 |
|  | Plot 0xx:<br>Measured Ambient voltage ripple: u-amb = xxx Vpp (>/< 2,5 V)   |











|   |  |
|---|--|
|  | Photos:  |
|   | Remove the oscilloscope connection from the test adapter.  |
| <i>Date/Time</i>  |  |
| 4.6   | <u>CE Voltage in Time Domain, Pwr-Return to Structure</u>  |
|   | <p>Connect the differential voltage probe "+" input to the SPIRE-FCU-main RETURN power line and the differential voltage probe "-" input to the satellite structure.</p> <p>Measure the differential voltage ripple with an oscilloscope (BW ≥ 50 MHz) in adequate time-/amplitude scaling.</p> <p>"return": DB01-J04 pin 8<br/>"satellite structure": ...tbd during test...</p> |
|  | <p>Plot 0xx:</p> <p>Measured Ambient voltage ripple: u-amb = xxx Vpp</p>   |
|  | Photos:  |
|   | Remove the oscilloscope connection from the test adapter.  |



|   |  |
|---|--|
| <b>5</b>  | <b>Reference/Ambient Test on <u>PACS-DPU-main</u> Power Lines</b>  |
| 5.1   | <u>REFERENCE Mode</u>  |
| <b>OP</b>   | If not already done switch into REFERENCE mode according to chapter 7.1 "A" and confirm the mode   |
| <b>OP</b>   | On Power SCOE verify the spacecraft OFF condition by SCOE parameters:  |
|   | <p>Main Bus Voltage= 0 V, Measured: U = _____</p> <p>Main Bus Current Output = A, Measured: I = _____</p>  |
| <i>Date/Time</i>  |  |
|   | <p>The measurement shall be done on the <b>PCDU/FPDPU_Nom_Pwrs SUP/RTN</b> lines.</p> <p>The power lines are accessible via the test adapter DB01-J05 (Figure 6-6).</p> <p>"plus": DB01-J05 pin 47//49<br/>"return": DB01-J05 pin 48//50</p>                         |
| <i>Date/Time</i>  |  |
| 5.2   | <u>CE Current in Frequency Domain, Common Mode</u>   |
|   | Set the current clamp on the PACS-DPU-main power lines for CM measurements in accordance to the CM set-up Figure 5-1: Schematic for CM and DM Measurements. Measure the ambient current from 30 Hz to 50 MHz.  |
|  | <p>Plot 0xx: 30 Hz – 10 kHz, CM-ambient, PACS-DPU -main -PWR</p> <p>Plot 0xx: 10 kHz – 1 MHz, CM-ambient, PACS-DPU -main -PWR</p> <p>Plot 0xx: 1 MHz – 30 MHz, CM-ambient, PACS-DPU -main -PWR</p> <p>Plot 0xx: 30 MHz – 50 MHz, CM-ambient, PACS-DPU -main -PWR</p> |
|  | Photos:  |




|   |   |
|---|---|
|   | Remove the current probe.   |
| <i>Date/Time</i>  |   |
| 5.3   | <u>CE Current in Frequency Domain, Differential Mode</u>  |
|   | Set the current clamp on the PACS-DPU -main power lines_for DM measurements in accordance to the DM set-up Figure 5-1: Schematic for CM and DM Measurements. Measure the ambient current from 30 Hz to 50 MHz.  |
|    | Plot 0xx: 30 Hz – 10 kHz, DM-ambient, PACS-DPU -main -PWR<br>Plot 0xx: 10 kHz – 1 MHz, DM-ambient, PACS-DPU -main -PWR<br>Plot 0xx: 1 MHz – 30 MHz, DM-ambient, PACS-DPU -main -PWR<br>Plot 0xx: 30 MHz – 50 MHz, DM-ambient, PACS-DPU -main -PWR                                   |
|    | Photos:   |
|   | Remove the current probe.   |
| <i>Date/Time</i>  |   |
| 5.4   | <u>CE Current in Time Domain, Differential Mode</u>   |
|   | Set the current clamp on the PACS-DPU -main power lines_for DM measurements as before. Measure the ambient DC current and the current ripple with an oscilloscope (BW ≥ 50 MHz).  |
|  | Plot 0xx:<br>Measured Ambient DC current: I-DCamb = xxx mA<br>Measured current ripple : I-amb = xxx mApp  |
|  | Photos:   |
|   | Remove the current probe.   |
| <i>Date/Time</i>  |   |
| 5.5   | <u>CE Voltage in Time Domain Differential Mode</u>  |
|   | Set the voltage probe on the PACS-DPU -main power lines_for DM voltage measurements and measure the differential ambient voltage ripple with an oscilloscope (BW ≥ 50 MHz) in adequate time-/amplitude scaling.<br><br>“plus”: DB01-J05 pin 47//49<br>“return”: DB01-J05 pin 48//50 |
|  | Plot 0xx:<br>Measured Ambient voltage ripple: u-amb = xxx Vpp (>/< 2,5 V)   |
|  | Photos:   |
|   | Remove the oscilloscope connection from the test adapter.   |
| <i>Date/Time</i>  |   |
| 5.6   | <u>CE Voltage in Time Domain, Pwr-Return to Structure</u>   |








|   |  |
|---|--|
|   | <p>Connect the differential voltage probe "+" input to the PACS-DPU -main RETURN power line and the differential voltage probe "-" input to the satellite structure.</p> <p>Measure the differential voltage ripple with an oscilloscope (BW ≥ 50 MHz) in adequate time-/amplitude scaling.</p> <p>"return": DB01-J05 pin 48//50<br/>"satellite structure": ... tbd during test...</p> |
|  | <p><b>Plot 0xx:</b></p> <p>Measured Ambient voltage ripple: <math>u\text{-amb} = \text{xxx Vpp}</math></p>   |
|  | <p>Photos:</p>   |
|   | <p>Remove the oscilloscope connection from the test adapter.</p>   |





|          |   |  |
|----------|---|--|
| <b>6</b> |   | <b>Reference/Ambient Test on <u>PACS-SPU-main</u> Power Lines</b>  |
| 6.1      |   | <u>REFERENCE Mode</u>  |
|          | <b>OP</b>   | If not already done, switch into REFERENCE mode according to chapter 7.1 "A" and confirm the mode  |
|          | <b>OP</b>   | On Power SCOE verify the spacecraft OFF condition by SCOE parameters:  |
|          |   | <p>Main Bus Voltage= 0 V, Measured: U = _____</p> <p>Main Bus Current Output = A, Measured: I = _____</p>  |
|          |   | <i>Date/Time</i>   |
|          |   | <p>The measurement shall be done on the <b>PCDU/FPSPU1_ Pwrs SUP/RTN</b> lines.</p> <p>The power lines are accessible via the test adapter DB01-J05 (Figure 6-6).</p> <p>"plus": DB01-J05 pin 1//3<br/>"return": DB01-J05 pin 2//4</p>                               |
|          |   | <i>Date/Time</i>   |
| 6.2      |   | <u>CE Current in Frequency Domain, Common Mode</u>   |
|          |   | Set the current clamp on the PACS-SPU-main power lines for CM measurements in accordance to the CM set-up Figure 5-1: Schematic for CM and DM Measurements. Measure the ambient current from 30 Hz to 50 MHz.  |
|          |  | <p>Plot 0xx: 30 Hz – 10 kHz, CM-ambient, PACS-SPU -main -PWR</p> <p>Plot 0xx: 10 kHz – 1 MHz, CM-ambient, PACS-SPU -main -PWR</p> <p>Plot 0xx: 1 MHz – 30 MHz, CM-ambient, PACS-SPU -main -PWR</p> <p>Plot 0xx: 30 MHz – 50 MHz, CM-ambient, PACS-SPU -main -PWR</p> |
|          |  | <p>Photos:</p>   |
|          |   | Remove the current probe.  |
|          |   | <i>Date/Time</i>   |
| 6.3      |   | <u>CE Current in Frequency Domain, Differential Mode</u>   |
|          |   | Set the current clamp on the PACS-SPU -main power lines for DM measurements in ac-   |







|   |   |
|---|---|
|   | cordance to the DM set-up Figure 5-1: Schematic for CM and DM Measurements. Measure the ambient current from 30 Hz to 50 MHz.   |
|    | Plot 0xx: 30 Hz – 10 kHz, DM-ambient, PACS-SPU -main -PWR<br>Plot 0xx: 10 kHz – 1 MHz, DM-ambient, PACS-SPU -main -PWR<br>Plot 0xx: 1 MHz – 30 MHz, DM-ambient, PACS-SPU -main -PWR<br>Plot 0xx: 30 MHz – 50 MHz, DM-ambient, PACS-SPU -main -PWR   |
|    | Photos:   |
|   | Remove the current probe.   |
| <i>Date/Time</i>  |   |
| 6.4   | <u>CE Current in Time Domain, Differential Mode</u>   |
|   | Set the current clamp on the PACS-SPU -main power lines_for DM measurements as before. Measure the ambient DC current and the current ripple with an oscilloscope (BW ≥ 50 MHz).  |
|    | Plot 0xx:<br>Measured Ambient DC current: I-DCamb = xxx mA<br>Measured current ripple : I-amb = xxx mApp  |
|  | Photos:   |
|   | Remove the current probe.   |
| <i>Date/Time</i>  |   |
| 6.5   | <u>CE Voltage in Time Domain Differential Mode</u>  |
|   | Set the voltage probe on the PACS-SPU -main power lines_for DM voltage measurements and measure the differential ambient voltage ripple with an oscilloscope (BW ≥ 50 MHz) in adequate time-/amplitude scaling.<br><br>“plus”: DB01-J05 pin 1//3<br>“return”: DB01-J05 pin 2//4   |
|  | Plot 0xx:<br>Measured Ambient voltage ripple: u-amb = xxx Vpp (>/< 2,5 V)   |
|  | Photos:   |
|   | Remove the oscilloscope connection from the test adapter.   |
| <i>Date/Time</i>  |   |
| 6.6   | <u>CE Voltage in Time Domain, Pwr-Return to Structure</u>   |
|   | Connect the differential voltage probe "+" input to the PACS-SPU -main RETURN power line and the differential voltage probe "-" input to the satellite structure.<br><br>Measure the differential voltage ripple with an oscilloscope (BW ≥ 50 MHz) in adequate time-/amplitude scaling.<br><br>“return”: DB01-J05 pin 2//4<br>"satellite structure": ...tbd during test... |

|   |  |
|---|--|
|  | <p>Plot 0xx:</p> <p>Measured Ambient voltage ripple: <math>u\text{-amb} = xxx \text{ Vpp}</math></p> |
|  | <p>Photos:</p>   |
|   | <p>Remove the oscilloscope connection from the test adapter.</p>                                     |






|          |   |   |
|----------|---|---|
| <b>7</b> |   | <b>Reference/Ambient Test on <u>PACS-BOLC-main</u> Power Lines</b>  |
| 7.1      |   | <u>REFERENCE Mode</u>   |
|          | <b>OP</b>   | <p>If not already done, switch into REFERENCE mode according to chapter 7.1 "A" and confirm the mode</p> <p>On Power SCOE verify the spacecraft OFF condition:</p> <p>Measured: <math>U = \underline{\hspace{2cm}}</math></p>                                       |
|          |   |   |
|          |   | <i>Date/Time</i>  |
|          |   | <p>The measurement shall be done on the <b>PCDU/FPBOLC_ Pwrs SUP/RTN</b> lines.</p> <p>The power lines are accessible via the test adapter DB01-J06 (Figure 6-7).</p> <p>"plus": DB01-J06 pin 13//17<br/>"return": DB01-J06 pin 14//18</p>                          |
|          |   | <i>Date/Time</i>  |
| 7.2      |   | <u>CE Current in Frequency Domain, Common Mode</u>  |
|          |   | <p>Set the current clamp on the PACS-BOLC-main power lines for CM measurements in accordance to the CM set-up Figure 5-1: Schematic for CM and DM Measurements. Measure the ambient current from 30 Hz to 50 MHz.</p>   |
|          |  | <p>Plot 0xx: 30 Hz – 10 kHz, CM-ambient, PACS-BOLC -main -PWR<br/>Plot 0xx: 10 kHz – 1 MHz, CM-ambient, PACS- BOLC -main -PWR<br/>Plot 0xx: 1 MHz – 30 MHz, CM-ambient, PACS- BOLC -main -PWR<br/>Plot 0xx: 30 MHz – 50 MHz, CM-ambient, PACS- BOLC -main -PWR</p>  |
|          |  | <p>Photos:</p>  |
|          |   | <p>Remove the current probe.</p>  |
|          |   | <i>Date/Time</i>  |
| 7.3      |   | <u>CE Current in Frequency Domain, Differential Mode</u>  |
|          |   | <p>Set the current clamp on the PACS-BOLC-main power lines for DM measurements in accordance to the DM set-up Figure 5-1: Schematic for CM and DM Measurements. Measure the ambient current from 30 Hz to 50 MHz.</p>   |
|          |  | <p>Plot 0xx: 30 Hz – 10 kHz, DM-ambient, PACS- BOLC -main -PWR<br/>Plot 0xx: 10 kHz – 1 MHz, DM-ambient, PACS- BOLC -main -PWR<br/>Plot 0xx: 1 MHz – 30 MHz, DM-ambient, PACS- BOLC -main -PWR<br/>Plot 0xx: 30 MHz – 50 MHz, DM-ambient, PACS- BOLC -main -PWR</p> |






|   |  |
|---|--|
|    | Photos:  |
|   | Remove the current probe.  |
|   |  |
| <i>Date/Time</i>  |  |
| 7.4   | <u>CE Current in Time Domain, Differential Mode</u>  |
|   | Set the current clamp on the PACS-BOLC-main power lines for DM measurements as before. Measure the ambient DC current and the current ripple with an oscilloscope (BW ≥ 50 MHz).   |
|    | Plot 0xx:<br>Measured Ambient DC current: I-DCamb = xxx mA<br>Measured current ripple : I-amb = xxx mApp   |
|    | Photos:  |
|   | Remove the current probe.  |
|   |  |
| <i>Date/Time</i>  |  |
| 7.5   | <u>CE Voltage in Time Domain Differential Mode</u>   |
|   | Set the voltage probe on the PACS-BOLC-main power lines for DM voltage measurements and measure the differential ambient voltage ripple with an oscilloscope (BW ≥ 50 MHz) in adequate time-/amplitude scaling.<br><br>"plus": DB01-J06 pin 13//17<br>"return": DB01-J06 pin 14//18  |
|  | Plot 0xx:<br>Measured Ambient voltage ripple: u-amb = xxx Vpp (>/< 2,5 V)  |
|  | Photos:  |
|   | Remove the oscilloscope connection from the test adapter.  |
|   |  |
| <i>Date/Time</i>  |  |
| 7.6   | <u>CE Voltage in Time Domain, Pwr-Return to Structure</u>  |
|   | Connect the differential voltage probe "+" input to the PACS-BOLC-main RETURN power line and the differential voltage probe "-" input to the satellite structure.<br><br>Measure the differential voltage ripple with an oscilloscope (BW ≥ 50 MHz) in adequate time-/amplitude scaling.<br><br>"return": DB01-J06 pin 14//18<br>"satellite structure": ... <i>td</i> during test... |
|  | Plot 0xx:<br>Measured Ambient voltage ripple: u-amb = xxx Vpp  |
|  | Photos:  |

|          |   |   |
|----------|---|---|
|          |   | Remove the oscilloscope connection from the test adapter.   |
| <b>8</b> |   | <b>Reference/Ambient Test on <u>PACS-MEC-main</u> Power Lines</b>   |
| 8.1      |   | <u>REFERENCE Mode</u>   |
|          | <b>OP</b>   | If not already done, switch into REFERENCE mode according to chapter 7.1 "A" and confirm the mode   |
|          |   | On Power SCOE verify the spacecraft OFF condition:<br><br>Measured: U = _____   |
|          |   |   |
|          | <i>Date/Time</i>  |   |
|          |   | The measurement shall be done on the <b>PCDU/FPMEC1_ Pwrs SUP/RTN</b> lines.<br><br>The power lines are accessible via the test adapter DB01-J05 (Figure 6-6).<br><br>"plus": DB01-J06 pin 13//17<br>"return": DB01-J06 pin 14//18                    |
|          | <i>Date/Time</i>  |   |
| 8.2      |   | <u>CE Current in Frequency Domain, Common Mode</u>  |
|          |   | Set the current clamp on the PACS-MEC-main power lines for CM measurements in accordance to the CM set-up Figure 5-1: Schematic for CM and DM Measurements. Measure the ambient current from 30 Hz to 50 MHz.   |
|          |  | Plot 0xx: 30 Hz – 10 kHz, CM-ambient, PACS-MEC -main -PWR<br>Plot 0xx: 10 kHz – 1 MHz, CM-ambient, PACS- MEC -main -PWR<br>Plot 0xx: 1 MHz – 30 MHz, CM-ambient, PACS- MEC -main -PWR<br>Plot 0xx: 30 MHz – 50 MHz, CM-ambient, PACS- MEC -main -PWR  |
|          |  | Photos:   |
|          |   | Remove the current probe.   |
|          |   |   |
|          | <i>Date/Time</i>  |   |
| 8.3      |   | <u>CE Current in Frequency Domain, Differential Mode</u>  |
|          |   | Set the current clamp on the PACS-MEC-main power lines for DM measurements in accordance to the DM set-up Figure 5-1: Schematic for CM and DM Measurements. Measure the ambient current from 30 Hz to 50 MHz.   |
|          |  | Plot 0xx: 30 Hz – 10 kHz, DM-ambient, PACS- MEC -main -PWR<br>Plot 0xx: 10 kHz – 1 MHz, DM-ambient, PACS- MEC -main -PWR<br>Plot 0xx: 1 MHz – 30 MHz, DM-ambient, PACS- MEC -main -PWR<br>Plot 0xx: 30 MHz – 50 MHz, DM-ambient, PACS- MEC -main -PWR |
|          |  | Photos:   |
|          |   | Remove the current probe.   |
|          |   |   |
|          | <i>Date/Time</i>  |   |
| 8.4      |   | <u>CE Current in Time Domain, Differential Mode</u>   |







|   |  |
|---|--|
|   | Set the current clamp on the PACS-MEC-main power lines for DM measurements as before. Measure the ambient DC current and the current ripple with an oscilloscope (BW ≥ 50 MHz).  |
|    | Plot 0xx:<br>Measured Ambient DC current: I-DCamb = xxx mA<br>Measured current ripple : I-amb = xxx mApp   |
|    | Photos:  |
|   | Remove the current probe.  |
| <i>Date/Time</i>  |  |
| 8.5   | <u>CE Voltage in Time Domain Differential Mode</u>   |
|   | Set the voltage probe on the PACS-MEC-main power lines for DM voltage measurements and measure the differential ambient voltage ripple with an oscilloscope (BW ≥ 50 MHz) in adequate time-/amplitude scaling.<br><br>“plus”: DB01-J05 pin 13//17<br>“return”: DB01-J05 pin 14//18   |
|  | Plot 0xx:<br>Measured Ambient voltage ripple: u-amb = xxx Vpp (>/< 2,5 V)  |
|  | Photos:  |
|   | Remove the oscilloscope connection from the test adapter.  |
| <i>Date/Time</i>  |  |
| 8.6   | <u>CE Voltage in Time Domain, Pwr-Return to Structure</u>  |
|   | Connect the differential voltage probe "+" input to the PACS-MEC-main RETURN power line and the differential voltage probe "-" input to the satellite structure.<br><br>Measure the differential voltage ripple with an oscilloscope (BW ≥ 50 MHz) in adequate time-/amplitude scaling.<br><br>“return”: DB01-J06 pin 14//18<br>"satellite structure": ...tbd during test... |
|  | Plot 0xx:<br>Measured Ambient voltage ripple: u-amb = xxx Vpp  |
|  | Photos:  |
|   | Remove the oscilloscope connection from the test adapter.  |
| <b>9</b>  | <b>Reference/Ambient Test on <u>CCU-main</u> Power Lines</b>   |
| 9.1   | <u>REFERENCE Mode</u>  |
| <b>OP</b>   | If not already done switch into REFERENCE mode according to chapter 7.1 “A” and con-   |













|   |   |
|---|---|
|   | firm the mode.<br>On Power SCOE verify the spacecraft OFF condition:<br><br>Measured: U = _____   |
| <i>Date/Time</i>  |   |
|   | The measurement shall be done on the <b>PCDU/CCU_A_Pwrs SUP/RTN</b> lines.<br><br>The power lines are accessible via the test adapter DB01-J01 (Figure 6-3).<br><br>"plus": DB01-J01 pin 18<br>"return": DB01-J01 pin 19      |
| <i>Date/Time</i>  |   |
| 9.2   | <u>CE Current in Frequency Domain, Common Mode</u>  |
|   | Set the current clamp on the CCU-main power lines for CM measurements in accordance to the CM set-up Figure 5-1: Schematic for CM and DM Measurements. Measure the ambient current from 30 Hz to 50 MHz.                      |
|   | Plot 0xx: 30 Hz – 10 kHz, CM-ambient, CCU -main -PWR<br>Plot 0xx: 10 kHz – 1 MHz, CM-ambient, CCU -main -PWR<br>Plot 0xx: 1 MHz – 30 MHz, CM-ambient, CCU -main -PWR<br>Plot 0xx: 30 MHz – 50 MHz, CM-ambient, CCU -main -PWR |
|  | Photos:   |
|   | Remove the current probe.   |
| <i>Date/Time</i>  |   |
| 9.3   | <u>CE Current in Frequency Domain, Differential Mode</u>  |
|   | Set the current clamp on the CCU -main power lines for DM measurements in accordance to the DM set-up Figure 5-1: Schematic for CM and DM Measurements. Measure the ambient current from 30 Hz to 50 MHz.                     |
|  | Plot 0xx: 30 Hz – 10 kHz, DM-ambient, CCU -main -PWR<br>Plot 0xx: 10 kHz – 1 MHz, DM-ambient, CCU -main -PWR<br>Plot 0xx: 1 MHz – 30 MHz, DM-ambient, CCU -main -PWR<br>Plot 0xx: 30 MHz – 50 MHz, DM-ambient, CCU -main -PWR |
|  | Photos:   |
|   | Remove the current probe.   |
| <i>Date/Time</i>  |   |
| 9.4   | <u>CE Current in Time Domain, Differential Mode</u>   |
|   | Set the current clamp on the CCU -main power lines for DM measurements as before. Measure the ambient DC current and the current ripple with an oscilloscope (BW ≥ 50 MHz).   |
|  | Plot 0xx:<br><br>Measured Ambient DC current: I-DCamb = xxx mA  |





|   |  |
|---|--|
|   | Measured current ripple : $I_{-amb} = xxx \text{ mApp}$  |
|    | Photos:  |
|   | Remove the current probe.  |
| <i>Date/Time</i>  |  |
| 9.5   | <u>CE Voltage in Time Domain Differential Mode</u>   |
|   | Set the voltage probe on the CCU -main power lines for DM voltage measurements and measure the differential ambient voltage ripple with an oscilloscope (BW $\geq$ 50 MHz) in adequate time-/amplitude scaling.<br><br>"plus": DB01-J01 pin 18<br>"return": DB01-J01 pin 19  |
|    | Plot 0xx:<br><br>Measured Ambient voltage ripple: $u_{-amb} = xxx \text{ Vpp}$ ( $>/< 2,5 \text{ V}$ )   |
|    | Photos:  |
|   | Remove the oscilloscope connection from the test adapter.  |
| <i>Date/Time</i>  |  |
| 9.6   | <u>CE Voltage in Time Domain, Pwr-Return to Structure</u>  |
|   | Connect the differential voltage probe "+" input to the CCU-main RETURN power line and the differential voltage probe "-" input to the satellite structure.<br><br>Measure the differential voltage ripple with an oscilloscope (BW $\geq$ 50 MHz) in adequate time-/amplitude scaling.<br><br>"return": DB01-J01 pin 19<br>"satellite structure": ... <i>tdb during test...</i> |
|  | Plot 0xx:<br><br>Measured Ambient voltage ripple: $u_{-amb} = xxx \text{ Vpp}$   |
|  | Photos:  |
|   | Remove the oscilloscope connection from the test adapter.  |

|                  |   |
|------------------|---|
| <b>10</b>        | <b>Reference/Ambient Test on <u>TWTA-EPC1</u> Power Lines</b>   |
| 10.1             | <u>REFERENCE Mode</u>   |
| <b>OP</b>        | If not already done switch into REFERENCE mode according to chapter 7.1 "A" and confirm the mode.                     |
|                  | On Power SCOE verify the spacecraft OFF condition by SCOE parameters:<br><br>Measured: $U = \underline{\hspace{2cm}}$ |
| <i>Date/Time</i> |   |



|   |   |
|---|---|
|   | <p>The measurement shall be done on the <b>PCDU/EPC1_Pwrs SUP/RTN</b> lines.</p> <p>The power lines are accessible via the test adapter DB01-J02 (Figure 6-4).</p> <p>“plus”: DB01-J02 pin 22//24<br/>“return”: DB01-J02 pin 23/25</p>                      |
| <i>Date/Time</i>  |   |
| 10.2  | <u>CE Current in Frequency Domain, Common Mode</u>  |
|   | Set the current clamp on the TWTA-EPC1-main power lines for CM measurements in accordance to the CM set-up Figure 5-1: Schematic for CM and DM Measurements. Measure the ambient current from 30 Hz to 50 MHz.  |
|    | <p>Plot 0xx: 30 Hz – 10 kHz, CM-ambient, TWTA-EPC1-main -PWR<br/>Plot 0xx: 10 kHz – 1 MHz, CM-ambient, TWTA-EPC1-main -PWR<br/>Plot 0xx: 1 MHz – 30 MHz, CM-ambient, TWTA-EPC1-main -PWR<br/>Plot 0xx: 30 MHz – 50 MHz, CM-ambient, TWTA-EPC1-main -PWR</p> |
|    | Photos:   |
|   | Remove the current probe.   |
| <i>Date/Time</i>  |   |
| 10.3  | <u>CE Current in Frequency Domain, Differential Mode</u>  |
|   | Set the current clamp on the TWTA-EPC1-main power lines for DM measurements in accordance to the DM set-up Figure 5-1: Schematic for CM and DM Measurements. Measure the ambient current from 30 Hz to 50 MHz.  |
|  | <p>Plot 0xx: 30 Hz – 10 kHz, DM-ambient, TWTA-EPC1-main -PWR<br/>Plot 0xx: 10 kHz – 1 MHz, DM-ambient, TWTA-EPC1-main -PWR<br/>Plot 0xx: 1 MHz – 30 MHz, DM-ambient, TWTA-EPC1-main -PWR<br/>Plot 0xx: 30 MHz – 50 MHz, DM-ambient, TWTA-EPC1-main -PWR</p> |
|  | Photos:   |
|   | Remove the current probe.   |
| <i>Date/Time</i>  |   |
| 10.4  | <u>CE Current in Time Domain, Differential Mode</u>   |
|   | Set the current clamp on the TWTA-EPC1-main power lines for DM measurements as before. Measure the ambient DC current and the current ripple with an oscilloscope (BW ≥ 50 MHz).  |
|  | <p>Plot 0xx:</p> <p>Measured Ambient DC current: I-DCamb = xxx mA<br/>Measured current ripple : I-amb = xxx mApp</p>  |
|  | Photos:   |
|   | Remove the current probe.   |
| <i>Date/Time</i>  |   |





|                  |  |  |
|------------------|--|--|
| 10.5             | <u>CE Voltage in Time Domain Differential Mode</u>   |  |
|                  | Set the voltage probe on the TWTA-EPC1-main power lines_for DM voltage measurements and measure the differential ambient voltage ripple with an oscilloscope (BW ≥ 50 MHz) in adequate time-/amplitude scaling.<br><br>“plus”: DB01-J02 pin 22//24<br>“return”: DB01-J02 pin 23/25   |  |
|                  |   | Plot 0xx:<br><br>Measured Ambient voltage ripple: u-amb = xxx Vpp (>/< 2,5 V)  |
|                  |   | Photos:  |
|                  | Remove the oscilloscope connection from the test adapter.  |  |
| <i>Date/Time</i> |  |  |
| 10.6             | <u>CE Voltage in Time Domain, Pwr-Return to Structure</u>  |  |
|                  | Connect the differential voltage probe "+" input to the TWTA-EPC1-main RETURN power line and the differential voltage probe "-" input to the satellite structure.<br><br>Measure the differential voltage ripple with an oscilloscope (BW ≥ 50 MHz) in adequate time-/amplitude scaling.<br><br>“return”: DB01-J02 pin 23/25<br>“satellite structure”: ...tbd during test... |  |
|                  |   | Plot 0xx:<br><br>Measured Ambient voltage ripple: u-amb = xxx Vpp  |
|                  |   | Photos:  |
|                  | Remove the oscilloscope connection from the test adapter.  |  |
| <b>11</b>        | <b>Reference/Ambient Test on <u>STR1</u> Power Lines</b>   |  |
| 11.1             | <u>REFERENCE Mode</u>  |  |
|                  | <b>OP</b>  | If not already done switch into REFERENCE mode according to chapter 7.1 “A” and confirm the mode<br><br>On Power SCOE verify the spacecraft OFF condition by SCOE parameters:<br><br>Measured: U = _____ |
| <i>Date/Time</i> |  |  |
|                  | The measurement shall be done on the <b>PCDU/STR1_Pwr SUP/RTN</b> lines.<br><br>The power lines are accessible via the test adapter DB01-J06 (Figure 6-7).<br><br>“plus”: DB01-J06 pin 27<br>“return”: DB01-J06 pin 28   |  |
| <i>Date/Time</i> |  |  |

|      |   |   |
|------|---|---|
| 11.2 |   | <u>CE Current in Frequency Domain, Common Mode</u>  |
|      |   | Set the current clamp on the STR1-main power lines for CM measurements in accordance to the CM set-up Figure 5-1: Schematic for CM and DM Measurements. Measure the ambient current from 30 Hz to 50 MHz.                     |
|      |    | Plot 0xx: 30 Hz – 10 kHz, CM-ambient, STR1-main -PWR<br>Plot 0xx: 10 kHz – 1 MHz, CM-ambient, STR1-main -PWR<br>Plot 0xx: 1 MHz – 30 MHz, CM-ambient, STR1-main -PWR<br>Plot 0xx: 30 MHz – 50 MHz, CM-ambient, STR1-main -PWR |
|      |    | Photos:   |
|      |   | Remove the current probe.   |
|      |   |   |
|      |   | <i>Date/Time</i>  |
| 11.3 |   | <u>CE Current in Frequency Domain, Differential Mode</u>  |
|      |   | Set the current clamp on the STR1-main power lines for DM measurements in accordance to the DM set-up Figure 5-1: Schematic for CM and DM Measurements. Measure the ambient current from 30 Hz to 50 MHz.                     |
|      |  | Plot 0xx: 30 Hz – 10 kHz, DM-ambient, STR1-main -PWR<br>Plot 0xx: 10 kHz – 1 MHz, DM-ambient, STR1-main -PWR<br>Plot 0xx: 1 MHz – 30 MHz, DM-ambient, STR1-main -PWR<br>Plot 0xx: 30 MHz – 50 MHz, DM-ambient, STR1-main -PWR |
|      |  | Photos:   |
|      |   | Remove the current probe.   |
|      |   |   |
|      |   | <i>Date/Time</i>  |
| 11.4 |   | <u>CE Current in Time Domain, Differential Mode</u>   |
|      |   | Set the current clamp on the STR1-main power lines for DM measurements as before. Measure the ambient DC current and the current ripple with an oscilloscope (BW ≥ 50 MHz).   |
|      |  | Plot 0xx:<br>Measured Ambient DC current: $I_{-DCamb} = xxx \text{ mA}$<br>Measured current ripple : $I_{-amb} = xxx \text{ mApp}$  |
|      |  | Photos:   |
|      |   | Remove the current probe.   |
|      |   |   |
|      |   | <i>Date/Time</i>  |
| 11.5 |   | <u>CE Voltage in Time Domain Differential Mode</u>  |
|      |   | Set the voltage probe on the STR1-main power lines for DM voltage measurements and measure the differential ambient voltage ripple with an oscilloscope (BW ≥ 50 MHz) in adequate time-/amplitude scaling.                    |
|      |   | “plus”: DB01-J06 pin 27<br>“return”: DB01-J06 pin 28  |



|   |  |
|---|--|
|    | <p>Plot 0xx:<br/>Measured Ambient voltage ripple: <math>u\text{-amb} = xxx \text{ Vpp}</math> (<math>&gt;/&lt; 2,5 \text{ V}</math>)</p>   |
|    | <p>Photos:</p>   |
|   | <p>Remove the oscilloscope connection from the test adapter.</p>   |
| <p><i>Date/Time</i><br/>11.6</p>  | <p><u>CE Voltage in Time Domain, Pwr-Return to Structure</u></p>   |
|   | <p>Connect the differential voltage probe "+" input to the STR1-main RETURN power line and the differential voltage probe "-" input to the satellite structure.</p> <p>Measure the differential voltage ripple with an oscilloscope (BW <math>\geq 50 \text{ MHz}</math>) in adequate time-/amplitude scaling.</p> <p>"return": DB01-J06 pin 28<br/>"satellite structure": ...tbd during test...</p> |
|   | <p>Plot 0xx:<br/>Measured Ambient voltage ripple: <math>u\text{-amb} = xxx \text{ Vpp}</math></p>  |
|  | <p>Photos:</p>   |
|   | <p>Remove the oscilloscope connection from the test adapter.</p>   |

#### 8.4 Reference/Ambient Tests on Signal Lines



| Test Step No., Executant  | Description/Comments   |
|---|--|
|   | <p><b>REFERENCE/AMBIENT TEST ON SIGNAL LINES</b></p> <p>In additional see paragraph 6.3 "Arrangements for Signal Lines", Figure 5-2 and Figure 5-3.</p> <p><b>Before starting an EMC test:</b></p> <p><b>Ckeck that all the EMC adapter connectors are mechanically secured against disconnecting by accident or stress!</b></p> <p><b>Pay special attention and take precautions when clamping and unclamping the measurement transducers (e.g. voltage- and current probes) to and from the EMC adapter wires. Wires may breake under stress.</b></p> <p><b>Note that the signal lines are shielded and the shield is rooted via the connector shells. So, when installing the EMC adapters and later performing the measurements, take care and measures that the shielding path is conductively not interrupted!</b></p> |
| <b>12</b>   | <b>Reference/Ambient Test on <u>TC</u> Signal Lines (RWL1)</b>   |
|   | <p>The measurement shall be done on the <b>Torque_Cmd SUP/RET</b> lines.</p> <p>The signal lines are accessible via the test adapter DB02-P01 (Figure 6-8, Figure 5-2).</p> <p>"plus": DB71- J02 pin 16<br/>"return": DB71- J02 pin 32</p>   |
| <i>Date/Time</i>  |  |
| 12.1  | <u>REFERENCE Mode</u>  |
| <b>OP</b>   | If not already done switch into REFERENCE mode according to chapter 7.1 "A" and confirm the mode   |
| <i>Date/Time</i>  |  |
| 12.2  | <u>CE Current in Frequency Domain, Common Mode</u>   |
|   | <p>Set the current clamp on the TC signal lines for CM measurements in accordance to the CM set-up Figure 5-1: Schematic for CM and DM Measurements.</p> <p>Measure the ambient current from 30 Hz to 50 MHz and compare the results with the limit of 77 dBµA. The ambient emissions shall be at least 6 dB below the requirement limit.</p>  |
| <br><b>Ambient</b> | <p>Plot 0xx: 30 Hz – 10 kHz, CM-ambient, TC-signal<br/>Plot 0xx: 10 kHz – 1 MHz, CM-ambient, TC-signal<br/>Plot 0xx: 1 MHz – 30 MHz, CM-ambient, TC-signal<br/>Plot 0xx: 30 MHz – 50 MHz, CM-ambient, TC-signal</p>  |
|                    | Photos:  |
|   | Remove the current probe.  |
| <i>Date/Time</i>  |  |

| Test Step No., Executant  | Description/Comments   |
|---|--|
| 12.3  | <u>CE Voltage in Time Domain Differential Mode</u>   |
|   | Set the voltage probe on the TC signal lines in accordance to the DM voltage set-up and measure the ambient voltage ripple with an oscilloscope (BW ≥ 50 MHz). The ambient emissions shall be at least 6 dB below the requirement limit of 300 mVpp.   |
| <br><b>Ambient</b>   | Plot 0xx:<br>Measured Ambient voltage ripple: u-amb = xxx Vpp (>/< 300 mVpp)   |
|                      | Photos:  |
|   | Remove the oscilloscope connection from the test adapter.  |
| <b>13</b>   | <b>Reference/Ambient Test on <u>TDC</u> Signal Lines (RWL1)</b>  |
|   | The measurement shall be done on the <b>Torque_Direction_Cmd SUP/RET</b> lines.<br><br>The signal lines are accessible via the test adapter DB02- P01 (Figure 6-8, Figure 5-3).<br><br>"plus": DB71- J02 pin 17<br>"return": DB71- J02 pin 37  |
| <i>Date/Time</i>  |  |
| 13.1  | <u>REFERENCE Mode</u>  |
| <b>OP</b>   | If not already done switch into REFERENCE mode according to chapter 7.1 "A" and confirm the mode.  |
| <i>Date/Time</i>  |  |
| 13.2  | <u>CE Current in Frequency Domain, Common Mode</u>   |
|   | Set the current clamp on the TDC signal lines for CM measurements in accordance to the CM set-up Figure 5-1: Schematic for CM and DM Measurements. Measure the ambient current from 30 Hz to 50 MHz and compare the results with the limit of 77 dBµA. The ambient emissions shall be at least 6 dB below the requirement limit. |
| <br><b>Ambient</b> | Plot 0xx: 30 Hz – 10 kHz, CM-ambient, TDC-signal<br>Plot 0xx: 10 kHz – 1 MHz, CM-ambient, TDC -signal<br>Plot 0xx: 1 MHz – 30 MHz, CM-ambient, TDC -signal<br>Plot 0xx: 30 MHz – 50 MHz, CM-ambient, TDC -signal   |
|                    | Photos:  |
|   | Remove the current probe.  |
| <i>Date/Time</i>  |  |
| 13.3  | <u>CE Voltage in Time Domain Differential Mode</u>   |
|   | Set the voltage probe on the TDC signal lines in accordance to the DM voltage set-up and measure the ambient voltage ripple with an oscilloscope (BW ≥ 50 MHz). The ambient emissions shall be at least 6 dB below the requirement limit of 300 mVpp.  |



| Test Step No.,<br>Executant   | Description/Comments   |
|---|--|
| <br><b>Ambient</b> | Plot 0xx:<br>Measured Ambient voltage ripple: $u_{\text{amb}} = \text{xxx Vpp}$ (>/< 150 mVpp) |
|                    | Photos:  |
|   | Remove the oscilloscope connection from the test adapter.                                      |







Xxxx








|   |           |  |
|---|-----------|--|
| <b>14</b>   |           | <b>Reference/Ambient Test on <u>ACC/1553</u> Signal Lines (MILBUS)</b>   |
|   |           | The measurement shall be done on the <b>MILBUS</b> lines.<br><br>The signal lines are accessible via the test adapter ACC-J23 (Figure 6-10).<br><br>"MIL1553_A_Nom": ACC-J23 pin 1<br>"MIL1553Rtn_A_Nom": ACC-J23 pin 11 |
| <i>Date/Time</i>  |           |  |
| 14.1  |           | <u>REFERENCE Mode</u>  |
|   | <b>OP</b> | If not already done switch into REFERENCE mode according to chapter 7.1 "A" and confirm the mode.  |
| <i>Date/Time</i>  |           |  |
| 14.2  |           | <u>CE Voltage in Time Domain Differential Mode</u>   |
|   |           | Set the voltage probe on the MILBUS signal lines in accordance to the DM voltage set-up and measure the ambient voltage ripple with an oscilloscope (BW ≥ 50 MHz).   |
| <br><b>Ambient</b> |           | Plot 0xx:<br>Measured Ambient voltage ripple: $u_{\text{amb}} = \text{xxx Vpp}$  |
|                    |           | Photos:  |
|   |           | Remove the oscilloscope connection from the test adapter.  |



## 8.5 Tests on Satellite Ground Line





| Test Step No.,<br>Executant | Description/Comments  |
|-----------------------------|---|
| 15                          | Test on <u>Satellite Ground</u> Line: This Test is deleted! |








## 8.6 Conducted Emission Tests on Power Lines









| Test Step No., Executant | Description/Comments   |
|--------------------------|--|
|                          | <p><b>CONDUCTED EMISSION TEST ON POWER LINES</b></p> <p>In additional see paragraph 5 "Test Requirements".<br/>The power lines under test accessibility and the current-/voltage probe arrangements are described in the previous chapter for "Reference/Ambient- measurements" and will not be repeated here!</p> <p><b>Before starting an EMC test:</b></p> <p><b>Ckeck that all the EMC adapter connectors are mechanically secured against disconnecting by accident or stress!</b></p> <p><b>Pay special attention and take precautions when clamping and unclamping the measurement transducers (e.g. voltage- and current probes) to and from the EMC adapter wires. Wires may breake under stress.</b></p>   |
| <b>16</b>                | <p><b>CE Test on <u>HIFI-LCU-main</u> Power Lines</b></p> <p>The measurement shall be done on the <b>PCDU/FHLCU_Pwrs SUP/RTN</b> lines.</p>  |
| 16.1                     | <p><u>NOISIEST Mode</u></p> <p><b>OP</b> If not already done, switch into NOISIEST mode according to chapter 7.1 "B4" and confirm the mode</p> <p><b>OP</b> Give nominal DC current to EMC. The value shall be recorded into the test report.</p> <p>WM709565 HiFiLCU_N_L53_I<br/>Nominal DC current: I-DCnom = xxx mA</p>   |
| <i>Date/Time</i>         |  |
| 16.2                     | <p><u>CE Current in Frequency Domain, Common Mode</u></p> <p>Measure the CM current from 30 Hz to 50 MHz.</p> <p>  Plot 0xx: 30 Hz – 10 kHz, CM-NomMode, HIFI-LCU-main -PWR<br/>  Plot 0xx: 10 kHz – 1 MHz, CM- NomMode, HIFI-LCU-main -PWR<br/>  Plot 0xx: 1 MHz – 30 MHz, CM- NomMode, HIFI-LCU-main -PWR<br/>  Plot 0xx: 30 MHz – 50 MHz, CM- NomMode, HIFI-LCU-main -PWR                 </p> <p> <span style="color: green;">Pass/</span><br/> <span style="color: red;">Fail</span> </p> <p>  Comments/Limit exceedings if any                 </p> <p>  Photos:                 </p> <p>Remove the current probe.</p> |
| <i>Date/Time</i>         |  |
| 16.3                     | <p><u>CE Current in Frequency Domain, Differential Mode</u></p> <p>Measure the CM current from 30 Hz to 50 MHz.</p>  |






| Test Step No., Executant   | Description/Comments  |
|--|---|
| <br><b>Pass/</b><br><b>Fail</b> | Plot 0xx: 30 Hz – 10 kHz, DM- NomMode, HIFI-LCU-main -PWR<br>Plot 0xx: 10 kHz – 1 MHz, DM- NomMode, HIFI-LCU-main -PWR<br>Plot 0xx: 1 MHz – 30 MHz, DM- NomMode, HIFI-LCU-main -PWR<br>Plot 0xx: 30 MHz – 50 MHz, DM- NomMode, HIFI-LCU-main -PWR   |
|                                 | Comments/Limit exceedings if any  |
|                                 | Photos:   |
|  | Remove the current probe.   |
| <i>Date/Time</i>   |   |
| 16.4   | <u>CE Current in Time Domain, Differential Mode</u>   |
|  | Measure the DC current and the current ripple with an oscilloscope (BW ≥ 50 MHz).   |
| <br><b>Pass/</b><br><b>Fail</b> | Measured Nominal DC current: $I_{-DCnom} = xxx \text{ mA}$<br><br>$I_{-DCnom} \leq 1 \text{ A} \rightarrow \text{Max ripple: } I_{-nom} \leq 60 \text{ mApp}$<br>$I_{-DCnom} > 1 \text{ A} \rightarrow \text{Max ripple: } I_{-nom} \leq [60 \text{ mApp} \times \text{sqr}(I_{-DCnom})] = xxx$<br><br>Plot 0xx: Current ripple<br><br>Measured current ripple: $I_{-nom} = xxx \text{ mApp}, \leq /> I_{-max} ?$ |
|                               | Photos:   |
|  | Remove the current probe.   |
| <i>Date/Time</i>   |   |
| 16.5   | <u>CE Voltage in Time Domain Differential Mode</u>  |
|  | Measure the differential voltage ripple with an oscilloscope (BW ≥ 50 MHz) in adequate time-/amplitude scaling.   |
|  | The expected voltage ripple shall be compared to 2,5 Vpp. This test for information only. No limit exists.  |
| <br><b>For info only</b>      | Plot 0xx:<br>Measured voltage ripple: $u_{-amb} = xxx \text{ Vpp} (>/< 2,5 \text{ V})$  |
|                               | Photos:   |
|  | Remove the oscilloscope connection from the test adapter.   |
| <i>Date/Time</i>   |   |
| 16.6   | <u>CE Voltage in Time Domain, Pwr-Return to Structure</u>   |
|  | Connect the differential voltage probe "+" input to the HIFI-LCU-main RETURN power line and the differential voltage probe "-" input to the satellite structure.<br><br>Measure the differential voltage ripple with an oscilloscope (BW ≥ 50 MHz) in adequate time-/amplitude scaling.   |

| Test Step No., Executant  | Description/Comments  |
|---|---|
|   | "return": DB01-J06 pin 2<br>"satellite structure": ... <i>tdb</i> during test...<br><br>and/or<br><br>"return": DB01-J04 pin 12<br>"satellite structure": ... <i>tdb</i> during test... |
|  | Plot 0xx:<br><br>Measured voltage ripple: $u_{-amb} = xxx \text{ Vpp}$  |
|  | Photos:   |
|   | Remove the oscilloscope connection from the test adapter.   |









|           |  |   |
|-----------|--|---|
| <b>17</b> |  | <b>CE Test on <u>HIFI-ICU-main</u> Power Lines</b>  |
|           |  | The measurement shall be done on the the <b>PCDU/FHICU_Nom_Pwr SUP/RTN</b> lines.   |
| 17.1      |  | <u>NOISIEST Mode</u>  |
|           | <b>OP</b>  | If not already done, switch into NOISIEST mode according to chapter 7.1 "B4" and confirm the mode   |
|           | <b>OP</b>  | Give nominal DC current to EMC. The value shall be recorded into the test report.<br><br>WM509565 HiFiICU_N_L64_I<br>Nominal DC current: $I_{-DCnom} = xxx \text{ mA}$  |
|           |  | <i>Date/Time</i>  |
| 17.2      |  | <u>CE Current in Frequency Domain, Common Mode</u>  |
|           |  | Measure the CM current from 30 Hz to 50 MHz.  |
|           | <br><b>Pass/<br/>Fail</b> | Plot 0xx: 30 Hz – 10 kHz, CM-NomMode, HIFI-ICU-main -PWR<br>Plot 0xx: 10 kHz – 1 MHz, CM- NomMode, HIFI-ICU-main -PWR<br>Plot 0xx: 1 MHz – 30 MHz, CM- NomMode, HIFI-ICU-main -PWR<br>Plot 0xx: 30 MHz – 50 MHz, CM- NomMode, HIFI-ICU-main -PWR  |
|           |                           | <u>Comments/Limit exceedings if any</u>   |
|           |                           | Photos:   |
|           |  | Remove the current probe.   |
|           |  | <i>Date/Time</i>  |
| 17.3      |  | <u>CE Current in Frequency Domain, Differential Mode</u>  |
|           |  | Measure the CM current from 30 Hz to 50 MHz.  |
|           | <br><b>Pass/<br/>Fail</b> | Plot 0xx: 30 Hz – 10 kHz, DM- NomMode, HIFI-ICU-main -PWR<br>Plot 0xx: 10 kHz – 1 MHz, DM- NomMode, HIFI-ICU-main -PWR<br>Plot 0xx: 1 MHz – 30 MHz, DM- NomMode, HIFI-ICU-main -PWR<br>Plot 0xx: 30 MHz – 50 MHz, DM- NomMode, HIFI-ICU-main -PWR |






|  |  |
|--|--|
|                                 | Comments/Limit exceedings if any   |
|                                 | Photos:  |
|  | Remove the current probe.  |
| <i>Date/Time</i>   |  |
| 17.4   | <u>CE Current in Time Domain, Differential Mode</u>  |
|  | Measure the DC current and the current ripple with an oscilloscope (BW ≥ 50 MHz).  |
| <br><b>Pass/</b><br><b>Fail</b> | Measured Nominal DC current: I-DCnom = xxx mA<br>I-DCnom ≤ 1 A → Max ripple: I-nom ≤ 60 mApp<br>I-DCnom > 1 A → Max ripple: I-nom ≤ [60 mApp x sqrt(I-DCnom)] = xxx<br><br>Plot 0xx: Current ripple<br><br>Measured current ripple: I-nom = xxx mApp, ≤/> I-max ?  |
|                                | Photos:  |
|  | Remove the current probe.  |
| <i>Date/Time</i>   |  |
| 17.5   | <u>CE Voltage in Time Domain Differential Mode</u>   |
|  | Measure the differential voltage ripple with an oscilloscope (BW ≥ 50 MHz) in adequate time-/amplitude scaling.  |
|  | The expected voltage ripple shall be compared to 2,5 Vpp. This test for information only. No limit exists.   |
| <br><b>For info only</b>      | Plot 0xx:<br>Measured voltage ripple: u-amb = xxx Vpp (>/< 2,5 V)  |
|                               | Photos:  |
|  | Remove the oscilloscope connection from the test adapter.  |
| <i>Date/Time</i>   |  |
| 17.6   | <u>CE Voltage in Time Domain, Pwr-Return to Structure</u>  |
|  | Connect the differential voltage probe "+" input to the HIFI-ICU-main RETURN power line and the differential voltage probe "-" input to the satellite structure.<br><br>Measure the differential voltage ripple with an oscilloscope (BW ≥ 50 MHz) in adequate time-/amplitude scaling.<br><br>"return": DB01-J05 pin 10<br>"satellite structure": ...tbd during test... |
|                               | Plot 0xx:<br>Measured voltage ripple: u-amb = xxx Vpp  |










|                  |  |   |
|------------------|--|---|
|                  |                             | Photos:   |
|                  |  | Remove the oscilloscope connection from the test adapter.   |
| <b>18</b>        |  | <b>CE Test on <u>SPIRE-FCU-main</u> Power Lines</b>   |
|                  |  | The measurement shall be done on the the <b>PCDU/HSFCU_Nom_Pwr SUP/RTN</b> lines.   |
| 18.1             |  | <u>NOISIEST Mode</u>  |
|                  | <b>OP</b>  | If not already done, switch into NOISIEST mode according to chapter 7.1 "B5" and confirm the mode   |
|                  | <b>OP</b>  | Give nominal DC current to EMC. The value shall be recorded into the test report.<br><br><a href="#">WM408565SpireHsfN_L51_I</a><br>Nominal DC current:    I-DCnom = xxx mA   |
| <i>Date/Time</i> |  |   |
| 18.2             |  | <u>CE Current in Frequency Domain, Common Mode</u>  |
|                  |  | Measure the CM current from 30 Hz to 50 MHz.  |
|                  | <br><b>Pass/<br/>Fail</b> | Plot 0xx: 30 Hz – 10 kHz, CM-NomMode, SPIRE-FCU-main -PWR<br>Plot 0xx: 10 kHz – 1 MHz, CM- NomMode, SPIRE-FCU -main -PWR<br>Plot 0xx: 1 MHz – 30 MHz, CM- NomMode, SPIRE-FCU -main -PWR<br>Plot 0xx: 30 MHz – 50 MHz, CM- NomMode, SPIRE-FCU -main -PWR   |
|                  |                           | Comments/Limit exceedings if any  |
|                  |                           | Photos:   |
|                  |  | Remove the current probe.   |
| <i>Date/Time</i> |  |   |
| 18.3             |  | <u>CE Current in Frequency Domain, Differential Mode</u>  |
|                  |  | Measure the CM current from 30 Hz to 50 MHz.  |
|                  | <br><b>Pass/<br/>Fail</b> | Plot 0xx: 30 Hz – 10 kHz, DM- NomMode, SPIRE-FCU -main -PWR<br>Plot 0xx: 10 kHz – 1 MHz, DM- NomMode, SPIRE-FCU -main -PWR<br>Plot 0xx: 1 MHz – 30 MHz, DM- NomMode, SPIRE-FCU -main -PWR<br>Plot 0xx: 30 MHz – 50 MHz, DM- NomMode, SPIRE-FCU -main -PWR |
|                  |                           | Comments/Limit exceedings if any  |
|                  |                           | Photos:   |
|                  |  | Remove the current probe.   |
| <i>Date/Time</i> |  |   |
| 18.4             |  | <u>CE Current in Time Domain, Differential Mode</u>   |
|                  |  | Measure the DC current and the current ripple with an oscilloscope (BW ≥ 50 MHz).   |
|                  |                           | Measured Nominal DC current:    I-DCnom = xxx mA<br><br>I-DCnom ≤ 1 A → Max ripple: I-nom ≤ 60 mApp   |







|   |   |
|---|---|
| <p><b>Pass/<br/>Fail</b></p>  | <p>I-DCnom &gt; 1 A → Max ripple: I-nom ≤ [60 mApp x sqr (I-DCnom)] = xxx</p> <p>Plot 0xx: Current ripple</p> <p>Measured current ripple: I-nom = xxx mApp, ≤/&gt; I-max ?</p>  |
|                              | <p>Photos:</p>  |
|   | <p>Remove the current probe.</p>  |
| <p>Date/Time</p>  |   |
| <p>18.5</p>   | <p><u>CE Voltage in Time Domain Differential Mode</u></p>   |
|   | <p>Measure the differential voltage ripple with an oscilloscope (BW ≥ 50 MHz) in adequate time-/amplitude scaling.</p>  |
|   | <p>The expected voltage ripple shall be compared to 2,5 Vpp. This test for information only. No limit exists.</p>   |
|  <p><b>For info only</b></p> | <p>Plot 0xx:</p> <p>Measured voltage ripple: u-amb = xxx Vpp (&gt;/&lt; 2,5 V)</p>  |
|                            | <p>Photos:</p>  |
|   | <p>Remove the oscilloscope connection from the test adapter.</p>  |
| <p>Date/Time</p>  |   |
| <p>18.6</p>   | <p><u>CE Voltage in Time Domain, Pwr-Return to Structure</u></p>  |
|   | <p>Connect the differential voltage probe "+" input to the SPIRE-FCU-main RETURN power line and the differential voltage probe "-" input to the satellite structure.</p> <p>Measure the differential voltage ripple with an oscilloscope (BW ≥ 50 MHz) in adequate time-/amplitude scaling.</p> <p>"return": DB01-J04 pin 8<br/>"satellite structure": ...<b>tdb during test...</b></p> |
|                            | <p>Plot 0xx:</p> <p>Measured voltage ripple: u-amb = xxx Vpp</p>  |
|                            | <p>Photos:</p>  |
|   | <p>Remove the oscilloscope connection from the test adapter.</p>  |
| <p><b>19</b></p>  | <p><b>CE Test on <u>PACS-DPU-main</u> Power Lines</b></p>   |
|   | <p>The measurement shall be done on the the <b>PCDU/FPDPU_Nom_Pwrs SUP/RTN</b> lines.</p>   |
| <p>19.1</p>   | <p><u>NOISIEST Mode</u></p>   |
|   | <p><b>OP</b> If not already done, switch into NOISIEST mode according to chapter 7.1 "B3" and confirm the mode</p>  |











|                  |  |   |
|------------------|--|---|
| <b>OP</b>        |  | Give nominal DC current to EMC. The value shall be recorded into the test report.<br><br>WM707565 PACSD_N_L41_I<br>Nominal DC current: I-DCnom = xxx mA   |
| <i>Date/Time</i> |  |   |
| 19.2             |  | <u>CE Current in Frequency Domain, Common Mode</u>  |
|                  |  | Measure the CM current from 30 Hz to 50 MHz.  |
|                  | <br><b>Pass/<br/>Fail</b>   | Plot 0xx: 30 Hz – 10 kHz, CM-NomMode, PACS-DPU-main -PWR<br>Plot 0xx: 10 kHz – 1 MHz, CM- NomMode, PACS-DPU -main -PWR<br>Plot 0xx: 1 MHz – 30 MHz, CM- NomMode, PACS-DPU -main -PWR<br>Plot 0xx: 30 MHz – 50 MHz, CM- NomMode, PACS-DPU -main -PWR                   |
|                  |                             | Comments/Limit exceedings if any  |
|                  |                             | Photos:   |
|                  |  | Remove the current probe.   |
| <i>Date/Time</i> |  |   |
| 19.3             |  | <u>CE Current in Frequency Domain, Differential Mode</u>  |
|                  |  | Measure the CM current from 30 Hz to 50 MHz.  |
|                  | <br><b>Pass/<br/>Fail</b> | Plot 0xx: 30 Hz – 10 kHz, DM- NomMode, PACS-DPU -main -PWR<br>Plot 0xx: 10 kHz – 1 MHz, DM- NomMode, PACS-DPU -main -PWR<br>Plot 0xx: 1 MHz – 30 MHz, DM- NomMode, PACS-DPU -main -PWR<br>Plot 0xx: 30 MHz – 50 MHz, DM- NomMode, PACS-DPU -main -PWR                 |
|                  |                           | Comments/Limit exceedings if any  |
|                  |                           | Photos:   |
|                  |  | Remove the current probe.   |
| <i>Date/Time</i> |  |   |
| 19.4             |  | <u>CE Current in Time Domain, Differential Mode</u>   |
|                  |  | Measure the DC current and the current ripple with an oscilloscope (BW ≥ 50 MHz).   |
|                  | <br><b>Pass/<br/>Fail</b> | Measured Nominal DC current: I-DCnom = xxx mA<br><br>I-DCnom ≤ 1 A → Max ripple: I-nom ≤ 60 mApp<br>I-DCnom > 1 A → Max ripple: I-nom ≤ [60 mApp x sqr (I-DCnom)] = xxx<br><br>Plot 0xx: Current ripple<br><br>Measured current ripple: I-nom = xxx mApp, ≤/> I-max ? |
|                  |                           | Photos:   |
|                  |  | Remove the current probe.   |
| <i>Date/Time</i> |  |   |
| 19.5             |  | <u>CE Voltage in Time Domain Differential Mode</u>  |







|  |   |
|--|---|
|  | Measure the differential voltage ripple with an oscilloscope (BW ≥ 50 MHz) in adequate time-/amplitude scaling.   |
|  | The expected voltage ripple shall be compared to 2,5 Vpp. This test for information only. No limit exists.  |
| <br><b>For info only</b>    | Plot 0xx:<br>Measured voltage ripple: u-amb = xxx Vpp (>/< 2,5 V)   |
|                             | Photos:   |
|  | Remove the oscilloscope connection from the test adapter.   |
| <i>Date/Time</i>   |   |
| 19.6   | <u>CE Voltage in Time Domain, Pwr-Return to Structure</u>   |
|  | Connect the differential voltage probe "+" input to the PACS-DPU -main RETURN power line and the differential voltage probe "-" input to the satellite structure.<br><br>Measure the differential voltage ripple with an oscilloscope (BW ≥ 50 MHz) in adequate time-/amplitude scaling.<br><br>"return": DB01-J05 pin 48//50<br>"satellite structure": ... <i>tdb during test...</i> |
| <br><b>For info only</b>  | Plot 0xx:<br>Measured voltage ripple: u-amb = xxx Vpp   |
|                           | Photos:   |
|  | Remove the oscilloscope connection from the test adapter.   |
| <b>20</b>  | <b>CE Test on <u>PACS-SPU-main</u> Power Lines</b>  |
|  | The measurement shall be done on the the the <b>PCDU/FPSPU1_ Pwrs SUP/RTN</b> lines.  |
| 20.1   | <u>NOISIEST Mode</u>  |
| <b>OP</b>  | If not already done, switch into NOISIEST mode according to chapter 7.1 "B3" and confirm the mode   |
| <b>OP</b>  | Give nominal DC current to EMC. The value shall be recorded into the test report.<br><br>WM506565 PacsS_N_L35_I<br>Nominal DC current: I-DCnom = xxx mA   |
| <i>Date/Time</i>   |   |
| 20.2   | <u>CE Current in Frequency Domain, Common Mode</u>  |
|  | Measure the CM current from 30 Hz to 50 MHz.  |
| <br><b>Pass/<br/>Fail</b> | Plot 0xx: 30 Hz – 10 kHz, CM-NomMode, PACS-SPU-main -PWR<br>Plot 0xx: 10 kHz – 1 MHz, CM- NomMode, PACS-SPU -main -PWR<br>Plot 0xx: 1 MHz – 30 MHz, CM- NomMode, PACS-SPU -main -PWR<br>Plot 0xx: 30 MHz – 50 MHz, CM- NomMode, PACS-SPU -main -PWR   |







|  |  |
|--|--|
|                     | Comments/Limit exceedings if any   |
|                     | Photos:  |
|  | Remove the current probe.  |
| <i>Date/Time</i>   |  |
| 20.3   | <u>CE Current in Frequency Domain, Differential Mode</u>   |
|  | Measure the CM current from 30 Hz to 50 MHz.   |
| <br>Pass/<br>Fail   | Plot 0xx: 30 Hz – 10 kHz, DM- NomMode, PACS-SPU -main -PWR<br>Plot 0xx: 10 kHz – 1 MHz, DM- NomMode, PACS-SPU -main -PWR<br>Plot 0xx: 1 MHz – 30 MHz, DM- NomMode, PACS-SPU -main -PWR<br>Plot 0xx: 30 MHz – 50 MHz, DM- NomMode, PACS-SPU -main -PWR                  |
|                     | Comments/Limit exceedings if any   |
|                     | Photos:  |
|  | Remove the current probe.  |
| <i>Date/Time</i>   |  |
| 20.4   | <u>CE Current in Time Domain, Differential Mode</u>  |
|  | Measure the DC current and the current ripple with an oscilloscope (BW ≥ 50 MHz).  |
| <br>Pass/<br>Fail | Measured Nominal DC current: I-DCnom = xxx mA<br><br>I-DCnom ≤ 1 A → Max ripple: I-nom ≤ 60 mApp<br>I-DCnom > 1 A → Max ripple: I-nom ≤ [60 mApp x sqrt (I-DCnom)] = xxx<br><br>Plot 0xx: Current ripple<br><br>Measured current ripple: I-nom = xxx mApp, ≤/> I-max ? |
|                   | Photos:  |
|  | Remove the current probe.  |
| <i>Date/Time</i>   |  |
| 20.5   | <u>CE Voltage in Time Domain Differential Mode</u>   |
|  | Measure the differential voltage ripple with an oscilloscope (BW ≥ 50 MHz) in adequate time-/amplitude scaling.  |
|  | The expected voltage ripple shall be compared to 2,5 Vpp. This test for information only. No limit exists.   |
| <br>For info only | Plot 0xx:<br>Measured voltage ripple: u-amb = xxx Vpp (>/< 2,5 V)  |
|                   | Photos:  |
|  | Remove the oscilloscope connection from the test adapter.  |









|                  |  |   |
|------------------|--|---|
| <i>Date/Time</i> |  |   |
| 20.6             |  | <u>CE Voltage in Time Domain, Pwr-Return to Structure</u>   |
|                  |  | Connect the differential voltage probe "+" input to the PACS-SPU -main RETURN power line and the differential voltage probe "-" input to the satellite structure.<br><br>Measure the differential voltage ripple with an oscilloscope (BW ≥ 50 MHz) in adequate time-/amplitude scaling.<br><br>"return": DB01-J05 pin 2//4<br>"satellite structure": ... <i>tdb during test...</i> |
|                  |                             | Plot 0xx:<br><br>Measured voltage ripple: $u_{-amb} = xxx \text{ Vpp}$  |
|                  |                             | Photos:   |
|                  |  | Remove the oscilloscope connection from the test adapter.   |
| <b>21</b>        |  | <b>CE Test on <u>PACS-BOLC-main</u> Power Lines</b>   |
|                  |  | The measurement shall be done on the the the <b>PCDU/FPBOLC_ Pwrs SUP/RTN</b> lines.  |
| 21.1             |  | <u>NOISIEST Mode</u>  |
|                  | <b>OP</b>  | If not already done, switch into NOISIEST mode according to chapter 7.1 "B3" and confirm the mode   |
|                  | <b>OP</b>  | Give nominal DC current to EMC. The value shall be recorded into the test report.<br><br>WM809565 PacsB_N_L27_I<br>Nominal DC current: $I_{-DCnom} = xxx \text{ mA}$  |
|                  | <b>Date/Time</b>   |   |
| 21.2             |  | <u>CE Current in Frequency Domain, Common Mode</u>  |
|                  |  | Measure the CM current from 30 Hz to 50 MHz.  |
|                  | <br><b>Pass/<br/>Fail</b> | Plot 0xx: 30 Hz – 10 kHz, CM-NomMode, PACS-BOLC -main -PWR<br>Plot 0xx: 10 kHz – 1 MHz, CM- NomMode, PACS-BOLC -main -PWR<br>Plot 0xx: 1 MHz – 30 MHz, CM- NomMode, PACS-BOLC -main -PWR<br>Plot 0xx: 30 MHz – 50 MHz, CM- NomMode, PACS-BOLC -main -PWR  |
|                  |                           | Comments/Limit exceedings if any  |
|                  |                           | Photos:   |
|                  |  | Remove the current probe.   |
|                  | <i>Date/Time</i>   |   |
| 21.3             |  | <u>CE Current in Frequency Domain, Differential Mode</u>  |
|                  |  | Measure the CM current from 30 Hz to 50 MHz.  |
|                  | <br><b>Pass/<br/>Fail</b> | Plot 0xx: 30 Hz – 10 kHz, DM- NomMode, PACS-BOLC -main -PWR<br>Plot 0xx: 10 kHz – 1 MHz, DM- NomMode, PACS-BOLC -main -PWR<br>Plot 0xx: 1 MHz – 30 MHz, DM- NomMode, PACS-BOLC -main -PWR<br>Plot 0xx: 30 MHz – 50 MHz, DM- NomMode, PACS-BOLC -main -PWR   |

|   |  |
|---|--|
|                            | Comments/Limit exceedings if any   |
|                            | Photos:  |
|   | Remove the current probe.  |
| <i>Date/Time</i>  |  |
| 21.4  | <u>CE Current in Time Domain, Differential Mode</u>  |
|   | Measure the DC current and the current ripple with an oscilloscope (BW ≥ 50 MHz).  |
| <br><b>Pass/<br/>Fail</b>  | <p>Measured Nominal DC current: I-DCnom = xxx mA</p> <p>I-DCnom ≤ 1 A → Max ripple: I-nom ≤ 60 mApp<br/>I-DCnom &gt; 1 A → Max ripple: I-nom ≤ [60 mApp x sqrt(I-DCnom)] = xxx</p> <p>Plot 0xx: Current ripple</p> <p>Measured current ripple: I-nom = xxx mApp, ≤/&gt; I-max ?</p>  |
|                          | Photos:  |
|   | Remove the current probe.  |
| <i>Date/Time</i>  |  |
| 21.5  | <u>CE Voltage in Time Domain Differential Mode</u>   |
|   | Measure the differential voltage ripple with an oscilloscope (BW ≥ 50 MHz) in adequate time-/amplitude scaling.  |
|   | The expected voltage ripple shall be compared to 2,5 Vpp. This test for information only. No limit exists.   |
| <br><b>For info only</b> | <p>Plot 0xx:</p> <p>Measured voltage ripple: u-amb = xxx Vpp (&gt;/&lt; 2,5 V)</p>   |
|                          | Photos:  |
|   | Remove the oscilloscope connection from the test adapter.  |
| <i>Date/Time</i>  |  |
| 21.6  | <u>CE Voltage in Time Domain, Pwr-Return to Structure</u>  |
|   | <p>Connect the differential voltage probe "+" input to the PACS-BOLC-main RETURN power line and the differential voltage probe "-" input to the satellite structure.</p> <p>Measure the differential voltage ripple with an oscilloscope (BW ≥ 50 MHz) in adequate time-/amplitude scaling.</p> <p>"return": DB01-J06 pin 14//18<br/>"satellite structure": ...<b>tbd during test...</b></p> |
|                          | Plot 0xx:  |






|   |   |
|---|---|
|   | Measured voltage ripple: $u_{-amb} = xxx \text{ Vpp}$     |
|  | Photos:   |
|   | Remove the oscilloscope connection from the test adapter. |










|           |  |   |
|-----------|--|---|
| <b>22</b> |  | <b>CE Test on <u>PACS-MEC-main</u> Power Lines</b>  |
|           |  | The measurement shall be done on the the the <b>PCDU/FPMEC1_ Pwrs SUP/RTN</b> lines.  |
| 22.1      |  | <u>NOISIEST Mode</u>  |
|           | <b>OP</b>  | If not already done, switch into NOISIEST mode according to chapter 7.1 "B3" and confirm the mode   |
|           | <b>OP</b>  | Give nominal DC current to EMC. The value shall be recorded into the test report.<br><br>WM510565 PacsMec1_L65_I<br>Nominal DC current: $I_{-DCnom} = xxx \text{ mA}$   |
|           | <b>Date/Time</b>   |   |
| 22.2      |  | <u>CE Current in Frequency Domain, Common Mode</u>  |
|           |  | Measure the CM current from 30 Hz to 50 MHz.  |
|           | <br><b>Pass/<br/>Fail</b> | Plot 0xx: 30 Hz – 10 kHz, CM- NomMode, PACS- MEC -main -PWR<br>Plot 0xx: 10 kHz – 1 MHz, CM- NomMode, PACS- MEC -main -PWR<br>Plot 0xx: 1 MHz – 30 MHz, CM- NomMode, PACS- MEC -main -PWR<br>Plot 0xx: 30 MHz – 50 MHz, CM- NomMode, PACS- MEC -main -PWR |
|           |                           | Comments/Limit exceedings if any  |
|           |                           | Photos:   |
|           |  | Remove the current probe.   |
|           | <b>Date/Time</b>   |   |
| 22.3      |  | <u>CE Current in Frequency Domain, Differential Mode</u>  |
|           |  | Measure the CM current from 30 Hz to 50 MHz.  |
|           | <br><b>Pass/<br/>Fail</b> | Plot 0xx: 30 Hz – 10 kHz, DM- NomMode, PACS- MEC -main -PWR<br>Plot 0xx: 10 kHz – 1 MHz, DM- NomMode, PACS- MEC -main -PWR<br>Plot 0xx: 1 MHz – 30 MHz, DM- NomMode, PACS- MEC -main -PWR<br>Plot 0xx: 30 MHz – 50 MHz, DM- NomMode, PACS- MEC -main -PWR |
|           |                           | Comments/Limit exceedings if any  |
|           |                           | Photos:   |
|           |  | Remove the current probe.   |
|           | <b>Date/Time</b>   |   |
| 22.4      |  | <u>CE Current in Time Domain, Differential Mode</u>   |
|           |  | Measure the DC current and the current ripple with an oscilloscope ( $BW \geq 50 \text{ MHz}$ ).  |



|   |  |
|---|--|
| <br><b>Pass/<br/>Fail</b>  | Measured Nominal DC current: $I\text{-DCnom} = xxx \text{ mA}$<br><br>$I\text{-DCnom} \leq 1 \text{ A} \rightarrow \text{Max ripple: } I\text{-nom} \leq 60 \text{ mApp}$<br>$I\text{-DCnom} > 1 \text{ A} \rightarrow \text{Max ripple: } I\text{-nom} \leq [60 \text{ mApp} \times \text{sqr}(I\text{-DCnom})] = xxx$<br><br>Plot 0xx: Current ripple<br><br>Measured current ripple: $I\text{-nom} = xxx \text{ mApp}, \leq/> I\text{-max} ?$ |
|                            | Photos:  |
|   | Remove the current probe.  |
| <i>Date/Time</i>  |  |
| 22.5  | <u>CE Voltage in Time Domain Differential Mode</u>   |
|   | Measure the differential voltage ripple with an oscilloscope (BW $\geq$ 50 MHz) in adequate time-/amplitude scaling.   |
|   | The expected voltage ripple shall be compared to 2,5 Vpp. This test for information only. No limit exists.   |
| <br><b>For info only</b> | Plot 0xx:<br>Measured voltage ripple: $u\text{-amb} = xxx \text{ Vpp} (>/< 2,5 \text{ V})$   |
|                          | Photos:  |
|   | Remove the oscilloscope connection from the test adapter.  |
| <i>Date/Time</i>  |  |
| 22.6  | <u>CE Voltage in Time Domain, Pwr-Return to Structure</u>  |
|   | Connect the differential voltage probe "+" input to the PACS-MEC-main RETURN power line and the differential voltage probe "-" input to the satellite structure.<br><br>Measure the differential voltage ripple with an oscilloscope (BW $\geq$ 50 MHz) in adequate time-/amplitude scaling.<br><br>"return": DB01-J06 pin 14//18<br>"satellite structure": ... <i>tdb during test...</i>  |
|                          | Plot 0xx:<br>Measured voltage ripple: $u\text{-amb} = xxx \text{ Vpp}$   |
|                          | Photos:  |
|   | Remove the oscilloscope connection from the test adapter.  |
| <b>23</b>   | <b>CE Test on <u>CCU-main</u> Power Lines</b>  |
|   | The measurement shall be done on the the the <b>PCDU/CCU_A_Pwrs SUP/RTN</b> lines.   |
| 23.1  | <u>NOISIEST Mode</u>   |





|                  |  |  |
|------------------|--|--|
|                  | <b>OP</b>  | If not already done, switch into NOISIEST mode according to chapter 7.1 "B3" and confirm the mode  |
|                  | <b>OP</b>  | Give nominal DC current to EMC. The value shall be recorded into the test report.<br><br>WM106565 Ccu_A_L37_I<br>Nominal DC current: I-DCnom = xxx mA  |
| <i>Date/Time</i> |  |  |
| 23.2             |  | <u>CE Current in Frequency Domain, Common Mode</u>   |
|                  |  | Measure the CM current from 30 Hz to 50 MHz.   |
|                  | <br><b>Pass/<br/>Fail</b>   | Plot 0xx: 30 Hz – 10 kHz, CM-NomMode, CCU-main -PWR<br>Plot 0xx: 10 kHz – 1 MHz, CM- NomMode, CCU -main -PWR<br>Plot 0xx: 1 MHz – 30 MHz, CM- NomMode, CCU -main -PWR<br>Plot 0xx: 30 MHz – 50 MHz, CM- NomMode, CCU -main -PWR  |
|                  |                             | Comments/Limit exceedings if any   |
|                  |                             | Photos:  |
|                  |  | Remove the current probe.  |
| <i>Date/Time</i> |  |  |
| 23.3             |  | <u>CE Current in Frequency Domain, Differential Mode</u>   |
|                  |  | Measure the CM current from 30 Hz to 50 MHz.   |
|                  | <br><b>Pass/<br/>Fail</b> | Plot 0xx: 30 Hz – 10 kHz, DM- NomMode, CCU -main -PWR<br>Plot 0xx: 10 kHz – 1 MHz, DM- NomMode, CCU -main -PWR<br>Plot 0xx: 1 MHz – 30 MHz, DM- NomMode, CCU -main -PWR<br>Plot 0xx: 30 MHz – 50 MHz, DM- NomMode, CCU -main -PWR                                      |
|                  |                           | Comments/Limit exceedings if any   |
|                  |                           | Photos:  |
|                  |  | Remove the current probe.  |
| <i>Date/Time</i> |  |  |
| 23.4             |  | <u>CE Current in Time Domain, Differential Mode</u>  |
|                  |  | Measure the DC current and the current ripple with an oscilloscope (BW ≥ 50 MHz).  |
|                  | <br><b>Pass/<br/>Fail</b> | Measured Nominal DC current: I-DCnom = xxx mA<br><br>I-DCnom ≤ 1 A → Max ripple: I-nom ≤ 60 mApp<br>I-DCnom > 1 A → Max ripple: I-nom ≤ [60 mApp x sqrt (I-DCnom)] = xxx<br><br>Plot 0xx: Current ripple<br><br>Measured current ripple: I-nom = xxx mApp, ≤/> I-max ? |
|                  |                           | Photos:  |
|                  |  | Remove the current probe.  |
| <i>Date/Time</i> |  |  |










|                  |   |   |
|------------------|---|---|
| 23.5             | <u>CE Voltage in Time Domain Differential Mode</u>  |   |
|                  | Measure the differential voltage ripple with an oscilloscope (BW ≥ 50 MHz) in adequate time-/amplitude scaling.   |   |
|                  | The expected voltage ripple shall be compared to 2,5 Vpp. This test for information only. No limit exists.  |   |
|                  |    | Plot 0xx:<br>Measured voltage ripple: u-amb = xxx Vpp (>/< 2,5 V)   |
|                  |    | Photos:   |
|                  | Remove the oscilloscope connection from the test adapter.   |   |
| <i>Date/Time</i> |   |   |
| 23.6             | <u>CE Voltage in Time Domain, Pwr-Return to Structure</u>   |   |
|                  | Connect the differential voltage probe "+" input to the CCU-main RETURN power line and the differential voltage probe "-" input to the satellite structure.<br><br>Measure the differential voltage ripple with an oscilloscope (BW ≥ 50 MHz) in adequate time-/amplitude scaling.<br><br>"return": DB01-J01 pin 19<br>"satellite structure": ...tbd during test... |   |
|                  |    | Plot 0xx:<br>Measured voltage ripple: u-amb = xxx Vpp   |
|                  |    | Photos:   |
|                  | Remove the oscilloscope connection from the test adapter.   |   |
| <b>24</b>        | <b>CE Test on <u>TWTA-EPC1</u> Power Lines</b>  |   |
|                  | The measurement shall be done on the the the <b>PCDU/EPC1_Pwrs SUP/RTN</b> lines.   |   |
| 24.1             | <u>NOISIEST Mode</u>  |   |
|                  | <b>OP</b>   | If not already done, switch into NOISIEST mode according to chapter 7.1 "B4" and confirm the mode   |
|                  | <b>OP</b>   | Give nominal DC current to EMC. The value shall be recorded into the test report.<br><br>WM210565 Twta_1_L49_I<br>Nominal DC current: I-DCnom = xxx mA                                |
| <i>Date/Time</i> |   |   |
| 24.2             | <u>CE Current in Frequency Domain, Common Mode</u>  |   |
|                  | Measure the CM current from 30 Hz to 50 MHz.  |   |
|                  |    | Plot 0xx: 30 Hz – 10 kHz, CM-NomMode, TWTA-EPC1-main -PWR<br>Plot 0xx: 10 kHz – 1 MHz, CM- NomMode, TWTA-EPC1-main -PWR<br>Plot 0xx: 1 MHz – 30 MHz, CM- NomMode, TWTA-EPC1-main -PWR |

|  |   |
|--|---|
| <b>Pass/<br/>Fail</b>  | Plot 0xx: 30 MHz – 50 MHz, CM- NomMode, TWTA-EPC1-main -PWR   |
|                             | Comments/Limit exceedings if any  |
|                             | Photos:   |
|  | Remove the current probe.   |
| <i>Date/Time</i>   |   |
| 24.3   | <u>CE Current in Frequency Domain, Differential Mode</u>  |
|  | Measure the CM current from 30 Hz to 50 MHz.  |
| <br><b>Pass/<br/>Fail</b>   | Plot 0xx: 30 Hz – 10 kHz, DM- NomMode, TWTA-EPC1-main -PWR<br>Plot 0xx: 10 kHz – 1 MHz, DM- NomMode, TWTA-EPC1-main -PWR<br>Plot 0xx: 1 MHz – 30 MHz, DM- NomMode, TWTA-EPC1-main -PWR<br>Plot 0xx: 30 MHz – 50 MHz, DM- NomMode, TWTA-EPC1-main -PWR                                     |
|                             | Comments/Limit exceedings if any  |
|                             | Photos:   |
|  | Remove the current probe.   |
| <i>Date/Time</i>   |   |
| 24.4   | <u>CE Current in Time Domain, Differential Mode</u>   |
|  | Measure the DC current and the current ripple with an oscilloscope (BW ≥ 50 MHz).   |
| <br><b>Pass/<br/>Fail</b> | Measured Nominal DC current: $I_{DCnom} = xxx \text{ mA}$<br><br>$I_{DCnom} \leq 1 \text{ A} \rightarrow \text{Max ripple: } I_{nom} \leq 60 \text{ mApp}$<br>$I_{DCnom} > 1 \text{ A} \rightarrow \text{Max ripple: } I_{nom} \leq [60 \text{ mApp} \times \text{sqr}(I_{DCnom})] = xxx$ |
|  | Plot 0xx: Current ripple  |
|  | Measured current ripple: $I_{nom} = xxx \text{ mApp}, \leq / > I_{max} ?$   |
|                           | Photos:   |
|  | Remove the current probe.   |
| <i>Date/Time</i>   |   |
| 24.5   | <u>CE Voltage in Time Domain Differential Mode</u>  |
|  | Measure the differential voltage ripple with an oscilloscope (BW ≥ 50 MHz) in adequate time-/amplitude scaling.   |
|  | The expected voltage ripple shall be compared to 2,5 Vpp. This test for information only. No limit exists.  |
| <br><b>For info only</b>  | Plot 0xx:<br>Measured voltage ripple: $u_{amb} = xxx \text{ Vpp} (>/< 2,5 \text{ V})$   |
|                           | Photos:   |

|   |  |
|---|--|
|   | Remove the oscilloscope connection from the test adapter.  |
| <i>Date/Time</i>  |  |
| 24.6  | <u>CE Voltage in Time Domain, Pwr-Return to Structure</u>  |
|   | <p>Connect the differential voltage probe "+" input to the TWTA-EPC1-main RETURN power line and the differential voltage probe "-" input to the satellite structure.</p> <p>Measure the differential voltage ripple with an oscilloscope (BW ≥ 50 MHz) in adequate time-/amplitude scaling.</p> <p>"return": DB01-J02 pin 23/25<br/>"satellite structure": ...tbd during test...</p> |
|  | <p>Plot 0xx:</p> <p>Measured voltage ripple: <math>u_{-amb} = xxx \text{ Vpp}</math></p>   |
|  | Photos:  |
|   | Remove the oscilloscope connection from the test adapter.  |

|  |  |
|--|--|
| <b>25</b>  | <b>CE Test on <u>STR1</u> Power Lines</b>  |
|  | The measurement shall be done on the the the <b>PCDU/STR1_Pwr SUP/RTN</b> lines.   |
| 25.1   | <u>NOISIEST Mode</u>   |
| <b>OP</b>  | If not already done, switch into NOISIEST mode according to chapter 7.1 "B4" and confirm the mode  |
| <b>OP</b>  | <p>Give nominal DC current to EMC. The value shall be recorded into the test report.</p> <p><b>WMA08565 STR_1_L21_I</b><br/>Nominal DC current: <math>I_{-DCnom} = xxx \text{ mA}</math></p>   |
| <i>Date/Time</i>   |  |
| 25.2   | <u>CE Current in Frequency Domain, Common Mode</u>   |
|  | Measure the CM current from 30 Hz to 50 MHz.   |
| <br><b>Pass/<br/>Fail</b> | <p>Plot 0xx: 30 Hz – 10 kHz, CM-NomMode, STR1-main -PWR<br/>Plot 0xx: 10 kHz – 1 MHz, CM- NomMode, STR1-main -PWR<br/>Plot 0xx: 1 MHz – 30 MHz, CM- NomMode, STR1-main -PWR<br/>Plot 0xx: 30 MHz – 50 MHz, CM- NomMode, STR1-main -PWR</p> |
|                           | Comments/Limit exceedings if any   |
|                           | Photos:  |
|  | Remove the current probe.  |
| <i>Date/Time</i>   |  |
| 25.3   | <u>CE Current in Frequency Domain, Differential Mode</u>   |
|  | Measure the CM current from 30 Hz to 50 MHz.   |
|                           | <p>Plot 0xx: 30 Hz – 10 kHz, DM- NomMode, STR1-main -PWR<br/>Plot 0xx: 10 kHz – 1 MHz, DM- NomMode, STR1-main -PWR</p>   |




|  |  |
|--|--|
| <b>Pass/</b><br><b>Fail</b>  | Plot 0xx: 1 MHz – 30 MHz, DM- NomMode, STR1-main -PWR<br>Plot 0xx: 30 MHz – 50 MHz, DM- NomMode, STR1-main -PWR  |
|                                 | Comments/Limit exceedings if any   |
|                                 | Photos:  |
|  | Remove the current probe.  |
| <i>Date/Time</i><br>25.4   | <u>CE Current in Time Domain, Differential Mode</u>  |
|  | Measure the DC current and the current ripple with an oscilloscope (BW ≥ 50 MHz).  |
| <br><b>Pass/</b><br><b>Fail</b> | Measured Nominal DC current: I-DCnom = xxx mA<br><br>I-DCnom ≤ 1 A → Max ripple: I-nom ≤ 60 mApp<br>I-DCnom > 1 A → Max ripple: I-nom ≤ [60 mApp x sqrt (I-DCnom)] = xxx<br><br>Plot 0xx: Current ripple<br><br>Measured current ripple: I-nom = xxx mApp, ≤/> I-max ?   |
|                               | Photos:  |
|  | Remove the current probe.  |
| <i>Date/Time</i><br>25.5   | <u>CE Voltage in Time Domain Differential Mode</u>   |
|  | Measure the differential voltage ripple with an oscilloscope (BW ≥ 50 MHz) in adequate time-/amplitude scaling.  |
|  | The expected voltage ripple shall be compared to 2,5 Vpp. This test for information only. No limit exists.   |
| <br><b>For info only</b>      | Plot 0xx:<br>Measured voltage ripple: u-amb = xxx Vpp (>/< 2,5 V)  |
|                               | Photos:  |
|  | Remove the oscilloscope connection from the test adapter.  |
| <i>Date/Time</i><br>25.6   | <u>CE Voltage in Time Domain, Pwr-Return to Structure</u>  |
|  | Connect the differential voltage probe "+" input to the STR1-main RETURN power line and the differential voltage probe "-" input to the satellite structure.<br><br>Measure the differential voltage ripple with an oscilloscope (BW ≥ 50 MHz) in adequate time-/amplitude scaling.<br><br>"return": DB01-J06 pin 28<br>"satellite structure": ...tbd during test... |







|   |  |
|---|--|
|  | <p>Plot 0xx:<br/>Measured voltage ripple: <math>u\text{-amb} = \text{xxx Vpp}</math></p> |
|  | <p>Photos:</p>   |
|   | <p>Remove the oscilloscope connection from the test adapter.</p>                         |

### 8.7 Tests on Satellite Ground Line


| Test Step No.,<br>Executant | Description/Comments   |
|-----------------------------|--|
| 26                          | Test on <u>Satellite Ground Line</u> : This test is deleted! |



## 8.8 Conducted Emission Tests on Signal Lines

| Test Step No., Executant   | Description/Comments  |
|--|---|
|  | <p><b>CE TEST ON SIGNAL LINES</b></p> <p>In additional see paragraph 5 "Test Requirements".<br/>The power lines under test accessibility and the current-/voltage probe arrangements are described in the previous chapter for "Reference/Ambient- measurements" and will not be repeated here!</p> <p><b>Before starting an EMC test:</b></p> <p><b>Ckeck that all the EMC adapter connectors are mechanically secured against disconnecting by accident or stress!</b></p> <p><b>Pay special attention and take precautions when clamping and unclamping the measurement transducers (e.g. voltage- and current probes) to and from the EMC adapter wires. Wires may breake under stress.</b></p> <p><b>Note that the signal lines are shielded and the shield is rooted via the connector shells. So, when installing the EMC adapters and later performing the measurements, take care and measures that the shielding path is conductively not interupted!</b></p> |
| <b>27</b>  | <p><b>CE Test on <u>TC</u> Signal Lines (RWL1)</b></p> <p>The measurement shall be done on the <b>Torque_Cmd SUP/RET</b> lines.</p>   |
| 27.1   | <p><u>NOISIEST Mode</u></p> <p><b>OP</b> If not already done, switch into NOISIEST mode according to chapter 7.1 "B4" and confirm the mode</p> <p><b>OP</b> Command TC to: 500 accdording to sect.7.1, B6<br/>Command TDC to: Clockwise<br/>Remark: The plots have to be recorded in less than 15 min. If not B6 has to be started again.<br/>Record and check setup information and give values to the EMC team.</p>   |
| <i>Date/Time</i>   |   |
| 27.2   | <p><u>CE Current in Frequency Domain, Common Mode</u></p> <p>Measure the current from 30 Hz to 50 MHz and compare the results with the limit of 77 dB<math>\mu</math>A.</p>   |
| <br><b>Pass/</b><br><b>Fail</b> | <p>Plot 0xx: 30 Hz – 10 kHz, CM-NomMode, TC-signal<br/>Plot 0xx: 10 kHz – 1 MHz, CM- NomMode, TC-signal<br/>Plot 0xx: 1 MHz – 30 MHz, CM- NomMode, TC-signal<br/>Plot 0xx: 30 MHz – 50 MHz, CM- NomMode, TC-signal</p>  |
|                                 | <p>Comments/Limit exceedings if any</p>   |
|                                 | <p>Photos:</p>  |
|  | <p>Remove the current probe.</p>  |

| Test Step No., Executant   | Description/Comments  |
|--|---|
| <i>Date/Time</i>   |   |
| 27.3   | <u>CE Voltage in Time Domain Differential Mode</u>  |
|  | Measure the voltage ripple with an oscilloscope (BW ≥ 50 MHz). The voltage ripple shall be compared to 300 mVpp. This test is <i>for information only</i> because no requirement limit exists.  |
| <br><b>For info only</b>    | Plot 0xx:<br>Measured voltage ripple: u-amb = xxx mVpp (>/< 300 mVpp)   |
|                             | Photos:   |
|  | Remove the oscilloscope connection from the test adapter.   |
| <b>28</b>  | <b>CE Test on <u>TDC</u> Signal Lines (RWL1)</b>  |
|  | The measurement shall be done on the <b>Torque_Direction_Cmd SUP/RET</b> lines.   |
| 28.1   | <u>NOISIEST Mode</u>  |
| <b>OP</b>  | If not already done, switch into NOISIEST mode according to chapter 7.1 "B4" and confirm the mode.  |
| <b>OP</b>  | Command TC to: 500 according to sect.7.1, B6<br>Command TDC to: Clockwise<br>Remark: The plots have to be recorded in less than 15 min. If not B6 has to be started again.<br>Record and check setup information and give values to the EMC team. |
| <i>Date/Time</i>   |   |
| 28.2   | <u>CE Current in Frequency Domain, Common Mode</u>  |
|  | Measure the current from 30 Hz to 50 MHz and compare the results with the limit of 77 dBµA.   |
| <br><b>Pass/<br/>Fail</b> | Plot 0xx: 30 Hz – 10 kHz, CM-ambient, TDC-signal<br>Plot 0xx: 10 kHz – 1 MHz, CM-ambient, TDC -signal<br>Plot 0xx: 1 MHz – 30 MHz, CM-ambient, TDC -signal<br>Plot 0xx: 30 MHz – 50 MHz, CM-ambient, TDC -signal                                  |
|                           | Comments/Limit exceedings if any  |
|                           | Photos:   |
|  | Remove the current probe.   |
| <i>Date/Time</i>   |   |
| 28.3   | <u>CE Voltage in Time Domain Differential Mode</u>  |
|  | Measure the voltage ripple with an oscilloscope (BW ≥ 50 MHz). The voltage ripple shall be compared to 300 mVpp. This test is <i>for information only</i> because no requirement limit exists.  |
|                           | Plot 0xx:   |





| Test Step No.,<br>Executant   | Description/Comments  |
|---|---|
| <b>For info only</b>  | Measured voltage ripple: $u_{\text{-amb}} = \text{xxx mVpp}$ ( $>/< 300 \text{ mVpp}$ ) |
|  | Photos:   |
|   | Remove the oscilloscope connection from the test adapter.                               |

|   |   |
|---|---|
| <b>29</b>   | <b>CE Test on <u>ACC/1553</u> Signal Lines (MILBUS)</b>   |
|   | <p>The measurement shall be done on the <b>MILBUS</b> lines.</p> <p>The signal lines are accessible via the test adapter ACC-J23 (Figure 6-10).</p> <p>“MIL1553_A_Nom”: ACC-J23 pin 1<br/>           “MIL1553Rtn_A_Nom”: ACC-J23 pin 11</p> |
| <i>Date/Time</i>  |   |
| 29.1  | <u>NOISIEST Mode</u>  |
| <b>OP</b>   | If not already done switch into NOISIEST mode according to chapter 7.1 “B4” and confirm the mode.   |
| <b>OP</b>   | Verify that MILBUS is active.   |
|   | Record and check setup information and give values to the EMC team.   |
| <i>Date/Time</i>  |   |
| 29.2  | <u>CE Voltage in Time Domain Differential Mode</u>  |
|   | Set the voltage probe on the MILBUS signal lines in accordance to the DM voltage set-up and measure the voltage ripple with an oscilloscope ( $\text{BW} \geq 50 \text{ MHz}$ ).  |
|  | Plot 0xx:   |
| <b>Info</b>   | Measured voltage ripple: $u_{\text{-amb}} = \text{xxx Vpp}$   |
|  | Photos:   |
|   | Remove the oscilloscope connection from the test adapter.   |

## 8.9 Conducted Susceptibility Tests on Signal Lines

| Test Step No., Executant | Description/Comments   |
|--------------------------|--|
|                          | <p><b>CS TEST ON SIGNAL LINES</b><br/>In additional see paragraph 5.6: "CS Voltage on Signal Lines (optional)", paragraph 6.1.2: "Signal line Test Adapter" and paragraph 6.3: "Arrangements for Signal Lines".</p> <p><b>Before starting an EMC test:</b></p> <p><b>Ckeck that all the EMC adapter connectors are mechanically secured against disconnecting by accident or stress!</b></p> <p><b>Pay special attention and take precautions when clamping and unclamping the measurement transducers (e.g. voltage- and current probes) to and from the EMC adapter wires. Wires may breake under stress.</b></p> <p><b>Note that the signal lines are shielded and the shield is rooted via the connector shells. So, when installing the EMC adapters and later performing the measurements, take care and measures that the shielding path is conductively not interrupted!</b></p>   |
| <b>30</b>                | <b>CS Test on <u>TC</u> Signal Lines (RWL1)</b>  |
| 30.1                     | <u>SENSITIVE Mode</u>  |
|                          | <b>OP</b> If not already done, switch into SENSITIVE mode according to chapter 7.1 "C" and confirm the mode  |
|                          | <i>Date/Time</i>   |
| 30.2                     | <p><b>OP/ EMC</b> <u>Arrangement of the test equipment:</u></p> <p>1) Arrange the test adapter according paragraph 6.3: "Arrangements for Signal Lines" and the test equipment according to Figure 5-5: TC Test Adapter arrangement for CS, DB02 level" and Figure 5-6: TDC Test Adapter arrangement for CS, DB02 level".</p> <p>2) I-AC injection and -monitoring on "Motor-Current-Monitor-Return" (MCM/TC_RET (32).): Fix current injection and -monitoring devices to MCM/TC_RET (32). Monitor the injected current with a spectrum analyser.</p> <p>3) Voltage "Torque-Command-Return to Structure":<br/>The voltage between TC-RET (32) and Structure (connector shell) shall be measured with a differential voltage probe and an oscilloscope.</p> <p>4) Voltage "Torque-Command" (TC+ (16) to TC-RET (32)):<br/>This TC command (500) shall be set by Sattelite/EGSE operational responsibilities.</p> <p>5) Voltage "Torque-Direction-Command" (MCM/TC_RET (32) to TDC + (17)):<br/>The TDC command (CLOCKWISE) shall be set by Sattelite/EGSE operational responsibilities.</p> <p>6) Voltage "Motor-Current-Monitor" (MCM (12) to MCM-RET (32)):<br/>This voltage (0,5105 V) shall be recorded and checked prior and during test by Sattelite/EGSE operational responsibilities.</p> |


| Test Step No.,<br>Executant | Description/Comments   |
|-----------------------------|--|
| 30.3                        | <p><b>OP</b> <u>Setup Conditions for TC/TDC Signal lines</u></p> <p>The TC command shall be set to "<b>500</b>" leading to a read out TLM (MCM) close to 0.5105V.<br/>The TDC command shall be set to: <b>Clockwise direction</b></p> <p>Record and check status information and give values to the EMC team.</p> <p><u>Actual TLM values:</u></p> <p>1) Command TC to: 500 according to sect.7.1, B6<br/>2) Command TDC to: Clockwise<br/>Remark: The plots / measurements have to be recorded in less than 15 min. If not B6 has to be started again.<br/>3) Mot Cur. TLM "MCM to MCM-RET: "... (shall be 0,5105 V)</p>                                      |
|                             | <p><u>Actual TLM values:</u></p> <p>1) I-inj = 0 mArms<br/>2) TC-RET (7) to Structure (connector shell) = xxx mVpp<br/>Osci Plot DXXX:<br/>3) Torque-Command" (TC+ (16) to TC-RET (32)) = xxx V<br/>4) Motor-Current-Monitor" (MCM (12) to MCM-RET (32)) = xxx V</p>   |
| 30.4                        | <p><u>CS testing:</u></p> <p>1) Adjust CS test frequency. Set the test voltage Voltage "Torque-Command-Return to Structure" to <b>2 Vpp</b> by slowly increasing the induced current I-AC.</p> <p>2) At the same time monitor the injected current with a spectrum analyser. In any case the injected current shall not exceed <b>100 mApp (91 dBµA)</b> even if the 2 Vpp test voltage cannot be reached!<br/>The 100 mApp limit applies only for the injected spectral frequency; amplitudes of other signal parts of the emission spectrum are not relevant.</p> <p>3) Give test status information to the Sattelite/EGSE operational responsibilities.</p> |
| 30.5                        | <p><b>OP/<br/>EMC</b> <u>Susceptibility evaluation:</u></p> <p>- The RWL shall not exhibit any failures malfunctions or unintended responses when submitted to the injected signals.<br/>- The motor current TLM shall keep inside the range +/-12.5 mV around the value without noise injection when submitted to the injected signals.</p> <p>4) Failure status and MCM voltage shall be monitored prior and during test by Sattelite/EGSE operational responsibilities.</p> <p>5) Give susceptibility status information to the EMC test team.</p>  |
|                             | <p><u>Susceptibility evaluation:</u></p> <p>- The motor current TLM (MCM (12) to MCM-RET (32)) shall keep inside the range +/-12.5 mV around the value without noise injection when submitted to the injected signals.</p> <p>6) The motor current (MCM) voltage shall be monitored prior and during test with a DMM</p>   |


| Test Step No., Executant  | Description/Comments  |
|---|---|
|   | <p>by the EMC team.</p> <p>7) Fill in the table <b>Fehler! Verweisquelle konnte nicht gefunden werden.</b> below for each tested frequency and check the susceptibility criteria.</p> <p>8) If susceptibility can be detected, reduce the induced voltage level to find the threshold value of susceptibility.</p> <p>9) If no susceptibility can be detected, go on testing with the next frequency.</p> |
|  | Plot 0xx:   |
|  | Photos:   |

| Time | f [kHz] | I-inj [dBµA] | Voltage "TC-RET to STRUC-TURE" [Vpp] | "TC to TC-RET" [V] | Mot Cur. TLM "MCM to MCM-RET" [V] | Observations /Comments |
|------|---------|--------------|--------------------------------------|--------------------|-----------------------------------|------------------------|
|      | 0       | 91 dBµA max  | 2 Vpp max                            | Xxxx V nom         | Xxxx V nom                        |                        |
|      | 50      |              |                                      |                    |                                   |                        |
|      | 100     |              |                                      |                    |                                   |                        |
|      | 200     |              |                                      |                    |                                   |                        |
|      | 400     |              |                                      |                    |                                   |                        |
|      | 600     |              |                                      |                    |                                   |                        |
|      | 800     |              |                                      |                    |                                   |                        |
|      | 1000    |              |                                      |                    |                                   |                        |
|      | 2000    |              |                                      |                    |                                   |                        |
|      | 3000    |              |                                      |                    |                                   |                        |
|      | 4000    |              |                                      |                    |                                   |                        |
|      | 5000    |              |                                      |                    |                                   |                        |
|      | 6000    |              |                                      |                    |                                   |                        |
|      | 7000    |              |                                      |                    |                                   |                        |
|      | 8000    |              |                                      |                    |                                   |                        |
|      | 9000    |              |                                      |                    |                                   |                        |
|      | 10000   |              |                                      |                    |                                   |                        |
|      | 12500   |              |                                      |                    |                                   |                        |
|      | 15000   |              |                                      |                    |                                   |                        |
|      | 17500   |              |                                      |                    |                                   |                        |
|      | 20000   |              |                                      |                    |                                   |                        |
|      | 25000   |              |                                      |                    |                                   |                        |
|      | 30000   |              |                                      |                    |                                   |                        |
|      | 35000   |              |                                      |                    |                                   |                        |
|      | 40000   |              |                                      |                    |                                   |                        |
|      | 45000   |              |                                      |                    |                                   |                        |
|      | 47500   |              |                                      |                    |                                   |                        |
|      | 48500   |              |                                      |                    |                                   |                        |
|      | 50000   |              |                                      |                    |                                   |                        |

**Table 8-1:** Frequency Table for CS Injection on TC Line

| Test Step No., Executant | Description/Comments   |
|--------------------------|--|
| 31                       | <b>CS Test on TDC Signal Lines (RWL1)</b>  |
| 31.1                     | <u>SENSITIVE Mode</u>  |
| <b>OP</b>                | If not already done, switch into SENSITIVE mode according to chapter 7.1 "C" and confirm the mode  |
| <i>Date/Time</i>         |  |
| 31.2                     | <p><b>OP/ EMC</b> <u>Arrangement of the test equipment:</u></p> <p>1) Arrange the test equipment according to Figure 5-6: TDC Test Adapter arrangement for CS, DB02 level".</p> <p>2) I-AC injection and -monitoring on "Motor-Current-Monitor-Return" and "Torque Direction Command" (MCM/TC_RET (32) and TDC+ (17));<br/>Fix current injection and -monitoring devices to MCM/TC_RET (32) and TDC+ (17). Monitor the injected current with an oscilloscope.</p> <p>3) I-ac monitoring of "Torque Direction Comman" (TDC+ (17));<br/>Fix current monitoring devices to TDC+ (17). Monitor the injected current with a frequency analyser.</p> <p>4) Voltage "Torque-Command-Return to Structure":<br/>The voltage between TC-RET (32) and Structure (connector shell) shall be measured with a differential voltage probe and an oscilloscope.</p> <p>5) Voltage "Torque-Direction-Command" (TDC+ (17) to TC-RET (32));<br/>The TDC command CLOCKWISE shall be given by Sattelite/EGSE operational responsibilities.</p> <p>6) Voltage "Torque-Command" (TC+ );<br/>The TC command (500) shall be given by the SATELLITE/EGSEoperational responsibilities.</p> <p>7) Voltage "Motor-Current-Monitor" (MCM (12) to MCM-RET (32));<br/>This voltage (0,50105V) shall be recorded and checked prior and during test by SATELLITE/EGSEoperational responsibilities.</p> |
| 31.3                     | <p><b>OP/ EMC</b> <u>Setup Conditions for TC/TDC Signal lines</u></p> <p>The TC command shall be set to "500" leading to a read out TLM (MCM) close to 0.5105V.<br/>The TDC command shall be set to: <b>CLOCKWISE direction</b></p> <p>Record and check status information and give values to the EMC team.</p> <p><u>Actual TLM values:</u></p> <p>1) Command TC to: 500 accdording to sect.7.1, B6<br/>2) Command TDC to: Clockwise<br/>Remark: The plots / measurements have to be recorded in less than 15 min. If not B6 has to be started again.<br/>3) Mot Cur. TLM "MCM to MCM-RET: "... (shall be 0,5105 V)</p>   |

| Test Step No.,<br>Executant   | Description/Comments   |
|---|--|
|   | <p><u>Actual TLM values:</u></p> <p>1) I-inj = 0 mArms<br/>                     2) TC-RET (32) to Structure (connector shell) = xxx mVpp<br/>                     Osci Plot DXXX:<br/>                     3) Torque-Command" (TC+ (16) to TC-RET (32)) = xxx V<br/>                     4) Motor-Current-Monitor" (MCM (12) to MCM-RET (32)) = xxx V</p>  |
| 31.4  | <p><u>CS testing:</u></p> <p>1) Adjust CS test frequency. Set the test voltage Voltage "Torque-Command-Return to Structure" to <b>2 Vpp</b> by slowly increasing the induced current I-AC.</p> <p>2) At the same time monitor the injected current on <u>both</u>, the MCM-RET line <u>and</u> TDC+ line with an oscilloscope. To avoid overtesting the injected current shall not exceed <b>tbd</b> mApp (<b>tbd</b> dBµA) even if the 2 Vpp test voltage cannot be reached! The <b>tbd</b> mApp limit applies only for the injected frequency.</p> <p>3) At the same time monitor the current on the TDC+ line <u>alone</u> with a spectrum analyser. In any case the current shall not exceed <b>100 mApp (91 dBµA)</b> even if the 2 Vpp test voltage cannot be reached!<br/>                     The 100 mApp limit applies only for the injected spectral frequency; amplitudes of other signal parts of the emission spectrum are not relevant.</p> <p>4) Give test status information to the SATELLITE/EGSEoperational responsibilities.</p> |
| 31.5  | <p><b>OP</b> <u>Susceptibility evaluation:</u></p> <p>- The RWL shall not exhibit any failures malfunctions or unintended responses when submitted to the injected signals.<br/>                     - The motor current TLM shall keep inside the range +/-12.5 mV around the value without noise injection when submitted to the injected signals.</p> <p>5) Failure status and MCM voltage shall be monitored prior and during test by SATELLITE/EGSEoperational responsibilities.</p> <p>6) Give susceptibility status information to the EMC test team.</p>   |
|   | <p><u>Susceptibility evaluation:</u></p> <p>- The motor current TLM (MCM (12) to MCM-RET (32)) shall keep inside the range +/-12.5 mV around the value without noise injection when submitted to the injected signals.</p> <p>7) The motor current (MCM) voltage shall be monitored prior and during test with a DMM be the EMC team.</p> <p>8) Fill in the table <b>Fehler! Verweisquelle konnte nicht gefunden werden.</b>below for each tested frequency and check the susceptibility criteria.</p> <p>9) If susceptibility can be detected, reduce the induced voltage level to find the threshold value of susceptibility.</p> <p>10) If no susceptibility can be detected, go on testing with the next frequency.</p>  |
|  | <p>Plot 0xx:</p>   |

| Test Step No., Executant  | Description/Comments |
|---|----------------------|
|  | Photos:              |

| Time | f [kHz] | I-inj, TC-RET and TDC+ [App] | I-TDC+, [dBµA] | Voltage "TC-RET to STRUCTURE" [Vpp] | "TDC to TC-RET" [V] | Mot Cur. TLM "MCM to MCM-RET" [V] | Observations/Comments |
|------|---------|------------------------------|----------------|-------------------------------------|---------------------|-----------------------------------|-----------------------|
|      | 0       | xxx App max                  | 91 dBµA max    | 2 Vpp max                           | Xxxx V nom          | Xxxx V nom                        |                       |
|      | 50      |                              |                |                                     |                     |                                   |                       |
|      | 100     |                              |                |                                     |                     |                                   |                       |
|      | 200     |                              |                |                                     |                     |                                   |                       |
|      | 400     |                              |                |                                     |                     |                                   |                       |
|      | 600     |                              |                |                                     |                     |                                   |                       |
|      | 800     |                              |                |                                     |                     |                                   |                       |
|      | 1000    |                              |                |                                     |                     |                                   |                       |
|      | 2000    |                              |                |                                     |                     |                                   |                       |
|      | 3000    |                              |                |                                     |                     |                                   |                       |
|      | 4000    |                              |                |                                     |                     |                                   |                       |
|      | 5000    |                              |                |                                     |                     |                                   |                       |
|      | 6000    |                              |                |                                     |                     |                                   |                       |
|      | 7000    |                              |                |                                     |                     |                                   |                       |
|      | 8000    |                              |                |                                     |                     |                                   |                       |
|      | 9000    |                              |                |                                     |                     |                                   |                       |
|      | 10000   |                              |                |                                     |                     |                                   |                       |
|      | 12500   |                              |                |                                     |                     |                                   |                       |
|      | 15000   |                              |                |                                     |                     |                                   |                       |
|      | 17500   |                              |                |                                     |                     |                                   |                       |
|      | 20000   |                              |                |                                     |                     |                                   |                       |
|      | 25000   |                              |                |                                     |                     |                                   |                       |
|      | 30000   |                              |                |                                     |                     |                                   |                       |
|      | 35000   |                              |                |                                     |                     |                                   |                       |
|      | 40000   |                              |                |                                     |                     |                                   |                       |
|      | 45000   |                              |                |                                     |                     |                                   |                       |
|      | 47500   |                              |                |                                     |                     |                                   |                       |
|      | 48500   |                              |                |                                     |                     |                                   |                       |
|      | 50000   |                              |                |                                     |                     |                                   |                       |

Table 8-2: Frequency Table for CS Injection on TDC Line

### 8.10 De-Installation of Test Adapters from Power- and Signal Lines

| Test Step No/<br>Info | Description/Comments  |
|-----------------------|---|
| 32                    | <b>DE-INSTALL TEST ADAPTER ON POWER- AND SIGNAL LINES LINES</b><br><br>Use information of paragraph 6.4 for deinstallation. |



**9 SUMMARY SHEETS**

**9.1 Procedure Variation Summary**

|                          |                    |                  |            |      |
|--------------------------|--------------------|------------------|------------|------|
|                          | <b>Test Change</b> |                  | Curr. No.: |      |
|                          |                    |                  | Date:      |      |
|                          |                    |                  | Page 1     | of 1 |
| Test designation         | Test Procedure     | Issue            | Rev.       |      |
| Herschel PFM EMC CE Test |                    | 1, dated         |            |      |
|                          |                    |                  |            |      |
|                          |                    |                  |            |      |
| Prepared by:             | Resp. Test Leader  | Project Engineer |            |      |
| Clemens Kalde            |                    |                  |            |      |
| PA/QA                    | Prime              | Customer         |            |      |

**Table 9-1:** Procedure Variation Sheet

**9.2 Non Conformance Report (NCR) Summary**

| NCR - No. | NCR - Title | Date | Open<br>Closed | PA<br>sig. |
|-----------|-------------|------|----------------|------------|
|           |             |      |                |            |

**Table 9-2:** Non- Conformance Record Sheet

**9.3 Sign-off Sheet**

|                    | Date | Signature |
|--------------------|------|-----------|
| Test Manager       |      |           |
| Operator           |      |           |
| PA Responsible     |      |           |
| ESA Representative |      |           |

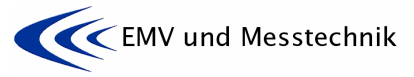
END OF DOCUMENT

|   | Name                    | Dep./Comp. |   | Name                         | Dep./Comp. |
|---|-------------------------|------------|---|------------------------------|------------|
|   | Alberti von Mathias Dr. | ASG23      |   | Schmidt Thomas               | AED15      |
|   | Baldock Richard         | FAE12      |   | Schuler Günter               | ASA42      |
|   | Barlage Bernhard        | AED13      |   | Schweickert Gunn             | ASG23      |
|   | Bayer Thomas            | ASA42      | x | Sonn Nico                    | ASG51      |
|   | Brune Holger            | ASA45      |   | Steininger Eric              | AED32      |
|   | Edelhoff Dirk           | AED2       | x | Stritter Rene                | AED11      |
|   | Fehringer Alexander     | ASG13      |   | Suess Rudi                   | OTN/ASA44  |
| x | Fricke Wolfgang Dr.     | AED 65     | x | Theunissen Martijn           | DSSA       |
|   | Geiger Hermann          | ASA42      | x | Vascotto Riccardo            | AED11      |
|   | Grasl Andreas           | OTN/ASA44  |   | Wagner Klaus                 | ASG23      |
|   | Grasshoff Brigitte      | AET12      | x | Wietbrock Walter             | AET12      |
| x | Hamer Simon             | Terma      |   | Wöhler Hans                  | ASG23      |
|   | Hendrikse Jeffrey       | HE Space   |   | Wössner Ulrich               | ASE252     |
|   | Hendry David            | Terma      |   | Zumstein Armin               | ASQ42      |
|   | Hengstler Reinhold      | ASA42      |   |                              |            |
|   | Hinger Jürgen           | ASG23      |   |                              |            |
| x | Hohn Rüdiger            | AED65      |   |                              |            |
|   | Hölzle Edgar Dr.        | AED32      |   |                              |            |
| x | Hopfgarten Michael      |            |   |                              |            |
|   | Huber Johann            | ASA42      |   |                              |            |
|   | Hund Walter             | ASE252     |   |                              |            |
| x | Idler Siegmund          | AED312     |   |                              |            |
|   | Ivány von András        | FAE12      |   |                              |            |
|   | Jahn Gerd Dr.           | ASG23      |   |                              |            |
| x | Kalde Clemens           | ASM2       |   |                              |            |
|   | Kameter Rudolf          | OTN/ASA42  | x | ESA/ESTEC                    | ESA        |
|   | Kettner Bernhard        | AET42      | x | Thales Alenia Space Cannes   | TAS-F      |
|   | Knoblauch August        | AET32      | x | Thales Alenia Space Torino   | TAS-I      |
| x | Koelle Markus           | ASA43      |   |                              |            |
| x | Koppe Axel              | AED312     |   | <b>Instruments:</b>          |            |
| x | Kroeker Jürgen          | AED65      | x | MPE (PACS)                   | MPE        |
| x | La Gioia Valentina      | Terma      | x | RAL (SPIRE)                  | RAL        |
|   | Lang Jürgen             | ASE252     | x | SRON (HIFI)                  | SRON       |
|   | Langenstein Rolf        | AED15      |   |                              |            |
|   | Langfermann Michael     | ASA41      |   |                              |            |
|   | Martin Olivier          | ASA43      |   | <b>Subcontractors:</b>       |            |
| x | Maukisch Jan            | ASA43      |   | Austrian Aerospace           | AAE        |
| x | Much Christoph          | ASA43      |   | Austrian Aerospace           | AAEM       |
|   | Müller Jörg             | ASA42      |   | BOC Edwards                  | BOCE       |
| x | Müller Martin           | ASA43      |   | Dutch Space Solar Arrays     | DSSA       |
|   | Peltz Heinz-Willi       | ASG13      |   | EADS Astrium Sub-Subsyst. &  | ASSE       |
|   | Pietroboni Karin        | AED65      |   | EADS CASA Espacio            | CASA       |
|   | Platzer Wilhelm         | AED2       |   | EADS CASA Espacio            | ECAS       |
|   | Reichle Konrad          | ASA42      |   | European Test Services       | ETS        |
|   | Runge Axel              | OTN/ASA44  |   | Patria New Technologies Oy   | PANT       |
|   | Sauer Maximilian Dr.    | AED65      |   | SENER Ingenieria SA          | SEN        |
| x | Schink Dietmar          | AED32      |   | Thales Alenia Space, Antwerp | TAS-ETCA   |



*Titel:  
Title:*

## EMC Test Procedure



*Project:  
Projekt:* **HERSCHEL**

*Dokument Nr.:  
Document No.:*

**HP-2-ASED-TP-0155**

*Ausgabe:  
Issue:* **1.1**

*Datum:  
Date:* **28.11.07**

---