

**HERSCHEL / PLANCK**

---

REPORT

---

**TITLE :** SVM TCS THERMAL ANALYSIS REPORT

DRL Item or D.R.D. No: E-06

---

Signatures and approvals on original

---

PREPARED: F. TESSARIN



CHECKED: F. TESSARIN

APPROVED: V. PEROTTO

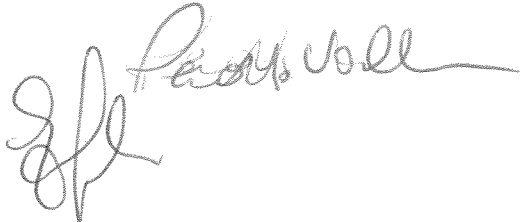

AUTHORIZED: E. SACCHI



APPROVALS:

SYSTEM ENGINEER

M. SIAS



THERMAL SYSTEM:

M. CAIROLA



PRODUCT ASSURANCE:

M. TOSI



CONFIGURATION CONTROL:

R. DROETTO



PROGRAM MANAGER:

P. MUSI



**DATA MANAGEMENT**

:



Date : 0803 2006

**DOCUMENT CHANGE RECORD**

<b>ISSUE</b>	<b>DATE</b>	<b>REASON FOR CHANGE</b>	<b>AFFECTED PARAGRAPHS</b>
<b>01</b>	<b>13/11/2002</b>	<b>New Issue</b>	<b>All</b>
<b>02</b>	<b>26/03/2004</b>	<b>Update for CDR</b>	<b>All</b>
<b>03</b>	<b>14/07/2004</b>	<b>Update System CDR</b>	<b>All</b>
<b>04</b>	<b>28/02/2005</b>	<b>Update for System CDR RID disposition</b>	<b>All</b>
<b>05</b>	<b>24/02/2006</b>	<b>Updated after TB/TV test correlation</b>	<b>Par 2.1, Par 3, Par 5.1, 5.2, 5.3, 5.4, Par 7.1, Par 8.1, 8.2, 8.4.1, 8.4.2, 8.4.3, 9.1</b>
	<b>24/02/2006</b>	<b>Updated after TV/TB test correlation</b>	<b>All</b>

## TABLE OF CONTENTS

<b>1</b>	<b>INTRODUCTION.....</b>	<b>10</b>
<b>2</b>	<b>APPLICABLE AND REFERENCE DOCUMENTS.....</b>	<b>11</b>
2.1	APPLICABLE DOCUMENTS.....	11
2.2	REFERENCE DOCUMENTS.....	13
2.3	LIST OF ACRONYMS.....	13
<b>3</b>	<b>HERSCHEL MODELS DESCRIPTION .....</b>	<b>14</b>
3.1.	HERSCHEL GMM AND TMM UPDATE TO FLIGHT CONFIGURATION.....	18
3.1.1	<i>HERSCHEL External GMM Variations.....</i>	<i>19</i>
3.1.2	<i>HERSCHEL Internal GMM Variations .....</i>	<i>30</i>
3.1.3	<i>HERSCHEL RCS Model Variations .....</i>	<i>37</i>
3.1.4	<i>HERSCHEL Power Dissipations Variations.....</i>	<i>50</i>
3.1.5	<i>HERSCHEL Units Conductors Variations.....</i>	<i>52</i>
3.1.6	<i>HERSCHEL SVM-Payload I/F points.....</i>	<i>55</i>
<b>4</b>	<b>PLANCK MODELS DESCRIPTION .....</b>	<b>57</b>
4.1	PLANCK GMM AND TMM VARIATION AFTER SYSTEM CDR DATA PACKAGE (JULY 2004).....	61
4.1.1	<i>PLANCK GMM Variations.....</i>	<i>61</i>
4.1.2	<i>PLANCK TMM Variations .....</i>	<i>66</i>
4.1.3	<i>PLANCK SVM-Payload I/F points .....</i>	<i>68</i>
4.1.4	<i>Solar Array Thermo optical properties.....</i>	<i>70</i>
4.1.5	<i>PLANCK Power dissipations.....</i>	<i>71</i>
4.1.6	<i>PLANCK Units Conductors.....</i>	<i>74</i>
<b>5</b>	<b>HERSCHEL &amp; PLANCK CONDUCTIVE COUPLINGS .....</b>	<b>77</b>
5.1	MLI CONDUCTIVITY .....	77
5.2	UNIT-PANEL CONDUCTIVITY.....	78
5.3	HONEYCOMB PANEL CONDUCTIVITY .....	79
5.4	DOUBLER – PANEL CONDUCTIVITY.....	81
5.5	CLEATS LINEAR CONDUCTIVITY.....	81
5.6	PLANCK HEAT PIPES CONDUCTIVITY .....	83
5.7	PLANCK SOLAR ARRAY CONDUCTIVITY .....	84
<b>6</b>	<b>HERSCHEL &amp; PLANCK MASS UPDATING .....</b>	<b>89</b>
<b>7</b>	<b>SVM INTERFACE REQUIREMENTS .....</b>	<b>91</b>
7.1	HERSCHEL REQUIREMENTS.....	91
7.2	PLANCK REQUIREMENTS.....	105
<b>8</b>	<b>THERMAL ANALYSIS .....</b>	<b>119</b>
8.1	HERSCHEL THERMAL ANALYSIS.....	119
8.2	HERSCHEL HEATER SIZING AND BREAKDOWN .....	122
8.3	THERMAL STABILITY .....	124
8.4	HERSCHEL THERMAL ANALYSIS RESULTS .....	125
8.4.1	<i>Transient Results .....</i>	<i>125</i>
8.4.2	<i>Transient Cases with Attitude Change Results.....</i>	<i>142</i>
8.4.3	<i>Heater Power Summary .....</i>	<i>144</i>

8.4.4	<i>Redundancy Analysis</i> .....	145
8.5	PLANCK THERMAL ANALYSIS.....	150
8.5.1	<i>SCC dissipation profile</i> .....	152
8.5.2	<i>Planck Heater Sizing and Breakdown</i> .....	156
8.5.3	<i>Thermal stability</i> .....	158
8.5.4	<i>Planck thermal analysis results</i> .....	159
8.5.4.1	Transient nominal results .....	159
8.5.4.2	Change of attitude transient case results .....	170
8.5.4.3	Heater Power Summary.....	171
8.5.4.4	Redundancy Analysis .....	172
8.5.4.5	Sun trapping on Solar Array .....	184
<b>9</b>	<b>CONCLUSIONS</b> .....	<b>185</b>
9.1	HERSCHEL .....	185
9.2	PLANCK.....	187
<b>10</b>	<b>HERSCHEL: TEMPERATURE PLOTS</b> .....	<b>189</b>
10.1	HERSCHEL RESULTS OF CASE B .....	189
10.2	HERSCHEL RESULTS OF CASE G.....	197
10.3	HERSCHEL RESULTS OF CASE I .....	205
10.4	HERSCHEL RESULTS OF CASE P .....	214
10.5	HERSCHEL RESULTS OF CASE Q.....	226
<b>11</b>	<b>PLANCK: TEMPERATURE PLOTS</b> .....	<b>237</b>
11.1	PLANCK: PLOTS OF TRANSIENT NOMINAL ANALYSIS CASE A3 .....	237
11.2	PLANCK: PLOTS OF TRANSIENT NOMINAL ANALYSIS CASE B2.....	252
11.3	PLANCK: PLOTS OF TRANSIENT NOMINAL ANALYSIS CASE C .....	267
11.4	PLANCK: PLOTS OF TRANSIENT CASE P1 .....	281
11.5	PLANCK: PLOTS OF TRANSIENT CASE P2.....	296
11.6	PLANCK: PLOTS OF TRANSIENT CASE Q1 .....	311
11.7	PLANCK: PLOTS OF TRANSIENT CASE Q2 .....	326

## LIST OF TABLES

Table 3.1.1-1 HERSCHEL – External MLI modifications .....	19
Table 3.1.1-2 HERSCHEL – SVM radiators areas updated .....	25
Table 3.1.1-3 HERSCHEL – Thrusters GMM .....	26
Table 3.1.1-4 HERSCHEL – SVM thermal-optical properties .....	29
Table 3.1.2-1 HERSCHEL – HIFI Panels GMM .....	30
Table 3.1.2-2 HERSCHEL – TWT Panel and units GMM remodelisation .....	33
Table 3.1.3-1 HERSCHEL – HIFI Panels TMM .....	35
Table 3.1.3-2 HERSCHEL – TT&C Panels TMM .....	35
Table 3.1.3-3 HERSCHEL – Thrusters TMM .....	36
Table 3.1.3-4 HERSCHEL – Thrusters brackets/Bottom Floor linear couplings .....	37
Table 3.1.4-1 HERSCHEL – RCS model summary .....	38
Table 3.1.5-1 HERSCHEL – Payload Units operating modes .....	50
Table 3.1.5-2 HERSCHEL - Units Power Dissipations .....	52
Table 3.1.6-1 HERSCHEL - Units-Panels conductance .....	54
Table 3.1.7-1 HERSCHEL – SVM-Payload I/F points .....	55
Table 4.1.1-1 PLANCK – Radiative and MLI Areas .....	65
Table 4.1.2-1 PLANCK – SVM Thermal-optical Properties .....	67
Table 4.1.3-1 PLANCK – SVM-Payload I/F points .....	68
Table 4.1.6-1 PLANCK – Payload Units operating modes .....	71
Table 4.1.6-2 PLANCK – Scientific Mode Power dissipations .....	73
Table 4.1.6-3 PLANCK – Telecom Mode Power dissipations .....	74
Table 4.1.7-1 PLANCK – Units-Panels conductors .....	76
Table 5-1 HERSCHEL - MLI Thermal Conductivity for different number of layers .....	78
Table 5.3-1 HERSCHEL – SVM Honeycomb panels & structural parts thermal properties .....	80
Table 5.3-2 PLANCK – SVM Honeycomb panels thermal properties .....	81
Table 5.3-3 HERSCHEL – SVM struts conductivity .....	81
Table 5.5-1 Cleats and inserts linear conductors .....	82
Table 6-1 PLANCK – Summary mass comparison between TMM and mechanical mass budget .....	89
Table 6-2 HERSCHEL – Mass Updating from BEE mechanical mass budget .....	89
Table 6-3 PLANCK – Mass Updating from BEE mechanical mass budget .....	90
Table 7.1-1 HERSCHEL – Requirements .....	92
Table 7.1-2 HERSCHEL - REQ ITP-100-H .....	94
Table 7.1-3 HERSCHEL - REQ ITP-120-H .....	95
Table 7.1-4 HERSCHEL - REQ ITP-130-H .....	95
Table 7.1-5 HERSCHEL REQ ITP-135-H .....	96
Table 7.1-6 HERSCHEL stability requirement (Cold case) .....	97
Table 7.1-7 HERSCHEL stability requirement (Hot case) .....	98
Table 7.1-8 HERSCHEL STR stability requirement (Cold case) .....	99
Table 7.1-9 HERSCHEL STR stability requirement (Hot case) .....	99
Table 7.1-10 HERSCHEL STR stability requirement (Cold Case) .....	100
Table 7.1-11 HERSCHEL STR stability requirement (Hot Case) .....	100
Table 7.1-12a HERSCHEL STR stability requirement (Cold Case) .....	101
Table 7.1-12b HERSCHEL STR stability requirement (Hot Case) .....	101
Table 7.1-13 HERSCHEL temperature gradient of SVM/PLM I/F points .....	104
Table 7.2-1 PLANCK – SVM I/F requirements .....	106
Table 7.2-2 PLANCK – ITP-150-P Temperature Results .....	107
Table 7.2-3 PLANCK – ITP-180-P Temperature Results .....	107
Table 7.2-4 PLANCK – ITP-200-P Temperature Results .....	107

Table 7.2-5 PLANCK – ITP-210-P Temperature Results .....	108
Table 7.2-6 PLANCK –ITP-170-P Flux Results .....	111
Table 7.2-7 PLANCK - ITP-170-P.....	114
Table 7.2-8 PLANCK - ITP-220-P.....	114
Table 7.2-9 PLANCK - ITP-230-P.....	115
Table 7.2-10 PLANCK - ITI-030-P.....	116
Table 7.2-11a PLANCK – SCC STABILITY.....	117
Table 7.2.11b PLANCK – gradient between each tank.....	118
Table 8.1-1 HERSCHEL – Analysis Cases.....	120
Table 8.2-1 HERSCHEL – Heater Circuits Breakdown and Temperature Thresholds.....	124
Table 8.4.1-1 HERSCHEL - Units Temperature results: Sizing Case BOL Nominal G and H.....	129
Table 8.4.1-2 HERSCHEL - Units Temperature results: Sizing Case BOL Survival I.....	133
Table 8.4.1-3 HERSCHEL - Units Temperature results: Sizing Case EOL Nominal A, B and C.....	137
Table 8.4.1-4 HERSCHEL - Units Temperature results: Sizing Case EOL Nominal D, E and F.....	141
Table 8.4.2-1 HERSCHEL – Transient cases: Min and Max temperatures (without uncertainty).....	143
Table 8.4.3-1 HERSCHEL – Average Heater Power Consumption in Nominal Cases.....	145
Table 8.4.4-1 HERSCHEL – Redundancy analysis temperature results .....	149
Table 8.5-1- PLANCK Transient nominal analysis cases .....	150
Table 8.5.1-1 PLANCK - Simplified BOL SCC model.....	153
Table 8.5.1-2 PLANCK - Simplified EOL SCC model.....	154
Table 8.5.1-3 PLANCK - Gas gap conductance .....	155
Table 8.5.2-1 PLANCK – Heater Circuits Breakdown and Temperature Thresholds .....	156
Table 8.5.4.1 PLANCK – Units Temperature Results.....	159
Table 8.5.4.3-1 PLANCK - Heater power need .....	171
Table 8.5.4.4-1 PLANCK - Redundancy analysis temperature results .....	173

## LIST OF FIGURES

Figure 3-1 HERSCHEL – Overall view +Z .....	15
Figure 3-2 HERSCHEL – Overall view -Z .....	16
Figure 3-3 HERSCHEL – Internal overall View.....	17
Figure 3.1.1-1 HERSCHEL – SVM external panels radiators layout .....	20
Figure 3.1.1-2a: HERSCHEL - +Y +Z MLI Lateral Panel & Units Internal View (See internal detail below).....	21
Figure 3.1.1-2b: HERSCHEL - +Y MLI Lateral Panel & Units Internal View.....	21
Figure 3.1.1-2c: HERSCHEL - +Y -Z MLI Lateral Panel & Units Internal View .....	22
Figure 3.1.1-2d: HERSCHEL - -Z MLI Lateral Panel & Units Internal View.....	22
Figure 3.1.1-2e: HERSCHEL - -Y -Z MLI Lateral Panel & Units Internal View .....	23
Figure 3.1.1-2f HERSCHEL - -Y MLI Lateral Panel & Units Internal View .....	23
Figure 3.1.1-2g: HERSCHEL - -Y +Z MLI Lateral Panel & Units Internal View.....	24
Figure 3.1.1-3 HERSCHEL – Thruster external view, Flight Configuration without external insulators.....	27
Figure 3.1.1-4 HERSCHEL – Thruster external view, TV/TB Configuration without external insulators .....	27
Figure 3.1.1-5 HERSCHEL – Thruster internal view .....	28
Figure 3.1.2-1 HERSCHEL – HIFI Short Panel new local mesh.....	30
Figure 3.1.2-2 HERSCHEL – HIFI Long Panel new local mesh .....	31
Figure 3.1.2-3 HERSCHEL – FHWOV/FHWOH old model.....	31
Figure 3.1.2-4 HERSCHEL – FHWOV/FHWOH new model .....	32
Figure 3.1.2-5 HERSCHEL – TT&C doublers new local mesh.....	34
Figure 3.1.2-6 HERSCHEL – TWT1 (X=6) / TWT2 (X=7) new model.....	34
Figure 3.1.4-1 HERSCHEL – RCS line9.....	39
Figure 3.1.4-2 HERSCHEL – RCS line9.....	40
Figure 3.1.4-3 HERSCHEL – RCS line9.....	41
Figure 3.1.4-4 HERSCHEL – RCS line11 .....	42
Figure 3.1.4-5 HERSCHEL – RCS line11 .....	43
Figure 3.1.4-6 HERSCHEL – RCS line35 .....	44
Figure 3.1.4-7 HERSCHEL – RCS line37 .....	45
Figure 3.1.4-8 HERSCHEL – RCS line37-45.....	46
Figure 3.1.4-9 HERSCHEL – RCS line45 .....	47
Figure 3.1.4-10 HERSCHEL – RCS line46 .....	48
Figure 3.1.4-11 HERSCHEL – RCS line47 .....	49
Figure 3.1.7-1 HERSCHEL – I/F points with PLM .....	56
Figure 4-1 PLANCK - Overall view.....	58
Figure 4-2 PLANCK - Overall view.....	59
Figure 4-3 PLANCK - Overall view (Groove shield not plotted) .....	59
Figure 4-4 PLANCK – Internal overall View.....	60
Figure 4.1.1-1 PLANCK Panel +Y+Z external radiative area.....	61
Figure 4.1.1-3 PLANCK - Wave Guides MLI blankets on panels +Y .....	62
Figure 4.1.1-4 PLANCK - Thermal doubler under 4K CCU and 4K CAU on +Y panel .....	63
Figure 4.1.1-5 PLANCK - Radiative areas layout.....	64
Figure 4.1.3-1 PLANCK - PLM I/F attachment points .....	69
Figure 4.1.5-1 PLANCK – Solar Array thermal-optical properties .....	70
Figure 5.2-1 Unit-Panel contact areas .....	79
Figure 5.5-1 Cleats conductors.....	82
Figure 5.7-1 PLANCK – Connection via screw.....	84
Figure 5.7-2 PLANCK – Connection Solar Array-Lateral panel.....	86
Figure 5.7-3 PLANCK – Connection Solar Array-Cone.....	88
Figure 7.1-1 HERSCHEL STR feet temperature gradient (COLD CASE P) .....	101
Figure 7.1-2 HERSCHEL STR feet temperature gradient (HOT CASE Q) .....	102

Figures 8.1-1 PLANCK - BOL Case A3 +Z panel.....	238
Figures 8.1-2 PLANCK - BOL CASE A3 +Y+Z panel .....	239
Figures 8.1-3 PLANCK - BOL CASE A3 +Y panel.....	240
Figures 8.1-4 PLANCK - BOL CASE A3 +Y-Z panel .....	241
Figures 8.1-5 PLANCK - BOL CASE A3 +Y-Z panel .....	242
Figures 8.1-6 PLANCK - BOL CASE A3 SCC I/F temperatures.....	243
Figures 8.1-7 PLANCK - BOL CASE A3 SCC I/F temperatures.....	244
Figures 8.1-8 PLANCK - BOL CASE A3 -Z panel .....	245
Figures 8.1-9 PLANCK - BOL CASE A3 -Y-Z panel.....	246
Figures 8.1-10 PLANCK - BOL CASE A3 -Y panel.....	247
Figures 8.1-11 PLANCK - BOL CASE A3 -Y+Z panel .....	248
Figures 8.1-12 PLANCK - BOL CASE A3 subplatform panel.....	249
Figures 8.1-13 PLANCK - BOL CASE A3 Helium TANK .....	250
Figures 8.1-14 PLANCK - BOL CASE A3 Propellant TANK.....	251
Figures 8.2-1 PLANCK - EOL CASE B2 +Z panel.....	253
Figures 8.2-2 PLANCK - EOL CASE B2 +Y+Z panel .....	254
Figures 8.2-3 PLANCK - EOL CASE B2 +Y panel .....	255
Figures 8.2-4 PLANCK - EOL CASE B2 +Y-Z panel.....	256
Figures 8.2-5 PLANCK - EOL CASE B2 SCC I/F temperatures.....	257
Figures 8.2-6 PLANCK - EOL CASE B2 SCC I/F temperatures.....	258
Figures 8.2-7 PLANCK - EOL CASE B2 -Z panel.....	259
Figures 8.2-8 PLANCK - EOL CASE B2 -Y-Z panel .....	260
Figures 8.2-9 PLANCK - EOL CASE B2 -Y-Z panel .....	261
Figures 8.2-10 PLANCK - EOL CASE B2 -Y panel .....	262
Figures 8.2-11 PLANCK - EOL CASE B2 -Y+Z panel.....	263
Figures 8.2-12 PLANCK - EOL CASE B2 subplatform panel .....	264
Figures 8.2-13 PLANCK - EOL CASE B2 propellant Tank .....	265
Figures 8.2-14 PLANCK - EOL CASE B2 He Tank .....	266
Figures 8.3-1 PLANCK - BOL CASE C +Z panel .....	268
Figures 8.3-2 PLANCK - BOL CASE C +Y+Z panel.....	269
Figures 8.3-3 PLANCK - BOL CASE C +Y panel.....	270
Figures 8.3-4 PLANCK - BOL CASE C - 4K CCU temperature .....	271
Figures 8.3-5 PLANCK - BOL CASE C +Y-Z panel .....	272
Figures 8.3-6 PLANCK - BOL CASE C SCC I/F temperature .....	273
Figures 8.3-7 PLANCK - BOL CASE C -Z panel .....	274
Figures 8.3-8 PLANCK - BOL CASE C -Y-Z panel.....	275
Figures 8.3-9 PLANCK - BOL CASE C -Y panel.....	276
Figures 8.3-10 PLANCK - BOL CASE C -Y+Z panel.....	277
Figures 8.3-11 PLANCK - BOL CASE C subplatform panel.....	278
Figures 8.3-12 PLANCK - BOL CASE C propellant Tank.....	279
Figures 8.3-13 PLANCK - BOL CASE C He Tank .....	280
Figures 8.4-1 PLANCK - BOL attitude change +Z panel .....	282
Figures 8.4-2 PLANCK - BOL attitude change +Y+Z panel .....	283
Figures 8.4-3 PLANCK - BOL attitude change +Y panel.....	284
Figures 8.4-4 PLANCK - BOL attitude change +Y-Z panel .....	285
Figures 8.4-5 PLANCK - BOL attitude change +Y-Z panel .....	286
Figures 8.4-6 PLANCK - BOL attitude change SCC I/F temperatures.....	287
Figures 8.4-7 PLANCK - BOL attitude change SCC I/F temperatures.....	288
Figures 8.4-8 PLANCK - BOL attitude change -Z panel .....	289
Figures 8.4-9 PLANCK - BOL attitude change -Y-Z panel.....	290
Figures 8.4-10 PLANCK - BOL attitude change -Y panel.....	291



Figures 8.4-11 PLANCK - BOL attitude change -Y+Z panel .....	292
Figures 8.4-12 PLANCK - BOL attitude change subplatform panel .....	293
Figures 8.4-13 PLANCK - BOL attitude change Helium TANK .....	294
Figures 8.4-14 PLANCK - BOL attitude change Propellant TANK.....	295
Figures 8.5-1 PLANCK - BOL attitude change +Z panel .....	297
Figures 8.5-2 PLANCK - BOL attitude change +Y+Z panel .....	298
Figures 8.5-3 PLANCK - BOL attitude change +Y panel.....	299
Figures 8.5-4 PLANCK - BOL attitude change +Y-Z panel .....	300
Figures 8.5-5 PLANCK - BOL attitude change SCC I/F temperatures.....	301
Figures 8.5-6 PLANCK - BOL attitude change SCC I/F temperatures.....	302
Figures 8.5-7 PLANCK - BOL attitude change -Z panel .....	303
Figures 8.5-8 PLANCK - BOL attitude change -Y-Z panel .....	304
Figures 8.5-9 PLANCK - BOL attitude change -Y-Z panel.....	305
Figures 8.5-10 PLANCK - BOL attitude change -Y panel.....	306
Figures 8.5-11 PLANCK - BOL attitude change -Y+Z panel .....	307
Figures 8.5-12 PLANCK - BOL attitude change subplatform panel .....	308
Figures 8.5-13 PLANCK - BOL attitude change Helium TANK .....	309
Figures 8.5-14 PLANCK - BOL attitude change Propellant TANK.....	310
Figures 8.6-1 PLANCK - EOL attitude change +Z panel .....	312
Figures 8.6-2 PLANCK - EOL attitude change +Y+Z panel .....	313
Figures 8.6-3 PLANCK - EOL attitude change +Y panel.....	314
Figures 8.6-4 PLANCK - EOL attitude change +Y-Z panel .....	315
Figures 8.6-5 PLANCK - EOL attitude change +Y-Z panel .....	316
Figures 8.6-6 PLANCK - EOL attitude change SCC I/F temperatures.....	317
Figures 8.6-7 PLANCK - EOL attitude change SCC I/F temperatures.....	318
Figures 8.6-8 PLANCK - EOL attitude change -Z panel .....	319
Figures 8.6-9 PLANCK - EOL attitude change -Y-Z panel.....	320
Figures 8.6-10 PLANCK - EOL attitude change -Y panel.....	321
Figures 8.6-11 PLANCK - EOL attitude change -Y+Z panel .....	322
Figures 8.6-12 PLANCK - EOL attitude change subplatform panel.....	323
Figures 8.6-13 PLANCK - EOL attitude change propellant Tank.....	324
Figures 8.6-14 PLANCK - EOL attitude change He Tank.....	325
Figures 8.7-1 PLANCK - EOL attitude change +Z panel .....	327
Figures 8.7-2 PLANCK - EOL attitude change +Y+Z panel .....	328
Figures 8.7-3 PLANCK - EOL attitude change +Y panel.....	329
Figures 8.7-4 PLANCK - EOL attitude change +Y-Z panel .....	330
Figures 8.7-5 PLANCK - EOL attitude change SCC I/F temperatures.....	331
Figures 8.7-6 PLANCK - EOL attitude change SCC I/F temperatures.....	332
Figures 8.7-7 PLANCK - EOL attitude change -Z panel .....	333
Figures 8.7-8 PLANCK - EOL attitude change -Y-Z panel .....	334
Figures 8.7-9 PLANCK - EOL attitude change -Y-Z panel.....	335
Figures 8.7-10 PLANCK - EOL attitude change -Y panel.....	336
Figures 8.7-11 PLANCK - EOL attitude change -Y+Z panel .....	337
Figures 8.7-12 PLANCK - EOL attitude change subplatform panel.....	338
Figures 8.7-13 PLANCK - EOL attitude change propellant Tank.....	339
Figures 8.7-14 PLANCK - EOL attitude change He Tank.....	340

## **1 INTRODUCTION**

The purpose of this document is the description of the geometric and thermal mathematical models built for HERSCHEL and PLANCK Service Modules as well as the presentation of the temperature results derived from the Flight thermal analysis performed for both satellites.

The updating of this document is related only to HERSCHEL S/L and an particular is due to the model correlation activities (after Thermal Balance Test) and IDB HIFI updating (Issue 3.3).

Some modification have been implemented according to the technical note H-P-TN-AI-0135 issued to close some action related to the MQR.

In particular they consist in:

- implementation of linear conductors due to the aluminium grounding rail, on the shear panel  $-Z+Y$
- reduction of the thermal closure linear conductors due to the cut outs in the structure
- increase of TANK thermal capacity according to the correlation activity in transient

## 2 APPLICABLE AND REFERENCE DOCUMENTS

### 2.1 APPLICABLE DOCUMENTS

[AD1]	Herschel/Planck Environment and Tests Requirements	H-P-1-ASPI-SP-0030
[AD2]	General Design & Interface Requirements	H-P-1-ASPI-SP-0027
[AD3]	SVM Mechanical Interface control document	H-P-IC-AI-0001
[AD4]	Reduced Geom. RGMM and Thermal RTMM Math. Models Requirements	H-P-RQ-AI-0002
[AD5]	SVM Requirement Specification	H-P-4-ASPI-SP-0019
[AD6]	SVM Interface Specification	H-P-4-ASPI-IS-0042
[AD7]	TCS Design Description	H-P-RP-AI-0039
[AD8]	PLANCK HEAT-PIPES Network Definition and Interfaces	H-P-TN-AI-0020
[AD9]	Thermal Interface control document	H-P-IC-AI-0002
[AD10]	Instrument Interface Document, Part B (IID-B): High Frequency Instrument	SCI-PT-IIDB/HFI-04141
[AD11]	Instrument Interface Document, Part B (IID-B): Low Frequency Instrument	SCI-PT-IIDB/LFI-04142
[AD12]	Instrument Interface Document, Part B (IID-B): Photo-conductor Instrument	SCI-PT-IIDB/PACS-2126
[AD13]	Instrument Interface Document, Part B (IID-B): Instrument "HIFI"	SCI-PT-IIDB/HIFI-2125
[AD14]	HERSCHEL AND PLANCK SAS Design and Analysis report	HP-4-TNO-RP-S004
[AD15]	HERSCHEL AND PLANCK AAD Design and Analysis Report	HP-4-TNO-RP-A004
[AD16]	THERMAL ANALYSIS FOR LGA OF HERSCHEL-PLANCK	HP-AN-RY-0020
[AD17]	THERMAL ANALYSIS FOR MGA OF HERSCHEL-PLANCK	HP-AN-RY-0021
[AD18]	PLM interface with HERSCHEL STR i01	H-P-ASP-LT-3814
[AD19]	PLANCK SVM Thermal Interfaces	H-P-1-ASP-TN-0417
[AD20]	HERSCHEL SVM Thermal Interfaces	H-P-1-ASP-TN-0418
[AD21]	UNCERTAINTY THERMAL ANALYSIS	H-P-TN-AI-0045
[AD22]	HEATER POWER UNCERTAINTY THERMAL ANALYSIS	H-P-TN-AI-0055
[AD23]	FINE CONTROL LAW ANALYSIS	H-P-TN-AI-0060

<b>[AD24]</b> HERSCHEL THERMAL ANALYSIS RESULTS AND BREAKDOWN	H-P-TN-AI-0065
<b>[AD25]</b> PLANCK THERMAL ANALYSIS RESULTS AND BREAKDOWN	H-P-TN-AI-0066
<b>[AD26]</b> Autonomous Star Tracker Thermal and Thermo-elastic analysis Report	H-P-4-GAF-RP-0009
<b>[AD27]</b> Reduced thermal mathematical model (SYNDA) - Northrop Grumman	654056 09/12/03
<b>[AD29]</b> HERSCHEL SVM TV/TB TEST CORRELATION REPORT	H-P-RP-AI-0153
<b>[AD30]</b> Thermo-optical Investigation for HERSCHEL SVM STM	TEC/QMC Report Number 4314 – issue 2

## 2.2 REFERENCE DOCUMENTS

- [RD1]** Thermal Conductivity of Metallic Honeycomb Sandwich Panels - NLR, Amsterdam, NL
- [RD2]** Analytical/Experimental Semiempirical Evaluation of Spacelab MLI Thermal Conductance  
RP-AI-0237, dated 13/09/78
- [RD3]** Survey and Evaluation of Multilayer Insulation Heat Transfer Measurements  
J.Doenecke (DASA), 23<sup>rd</sup> ICES, July 1993 - paper n.SAE 932117
- [RD4]** A Systematic Approach to Thermal Balance Test Evaluation and Thermal Mathematical Model  
Correlation for Spacecraft Thermal Design, L.Costamagna, V.Perotto, E.Sacchi (Alenia Spazio), 4<sup>th</sup>  
European Symposium on Space Environmental and Control Systems, October 1991.
- [RD5]** H-P-TN-AI-0135 Addendum to HERSCHEL TB/TV Test correlation

## 2.3 LIST OF ACRONYMS

AAD	: Attitude Anomaly Detector
BOL	: Beginning of Life
EOL	: End of Life
GMM	: Geometrical Mathematical Model
GYRO	: Gyroscope
HPLM	: Herschel Payload Module
H/W	: Hardware
LGA	: Low Gain antenna
MGA	: Medium Gain antenna
MLI	: Multi Layer Insulation
OSR	: Optical Solar Reflector
PPLM	: Planck Payload Module
P.Tanks	: Propellant Tanks
PTSS	: Propellant Tank Support Structure
rpm	: revolution per minute
S/C	: Spacecraft or Satellite
SAS	: Sun Acquisition sensor
SCC	: Sorption Cooler Compressors
STR	: Star Trackers
TBC	: To Be Confirmed
TBD	: To Be Defined
TMM	: Thermal Mathematical Model
VDA	: Vacuum Deposited Aluminum

### **3 HERSCHEL MODELS DESCRIPTION**

The Geometric Mathematical Model (GMM) of HERSCHEL satellite has been built using Esarad (version 5.3.2) software and it is composed by two models, which describe respectively the internal enclosures of the spacecraft and the external environment of the spacecraft. A reduced model of the Payload Module, furnished by ALCATEL [AD20], has been introduced in the external GMM. Due to the huge distance of the orbit from the Earth, solar, albedo and earth fluxes have been considerate as one global flux in the thermal analysis. An overall view is shown in Figures 3-1 to 3-3.

The Thermal Mathematical Model (TMM) of HERSCHEL has been prepared with Esatan software and contains the thermal node description, the thermal conductivity network and the unit and heater dissipation.

The correlated model has a total of 3890 nodes:

- 1595 in the external geometrical model
- 1322 in the internal geometrical model
- 30 in the PLM reduced model
- 138 in the detailed STR model
- 126 in the detailed Thrusters model
- 679 mathematical nodes

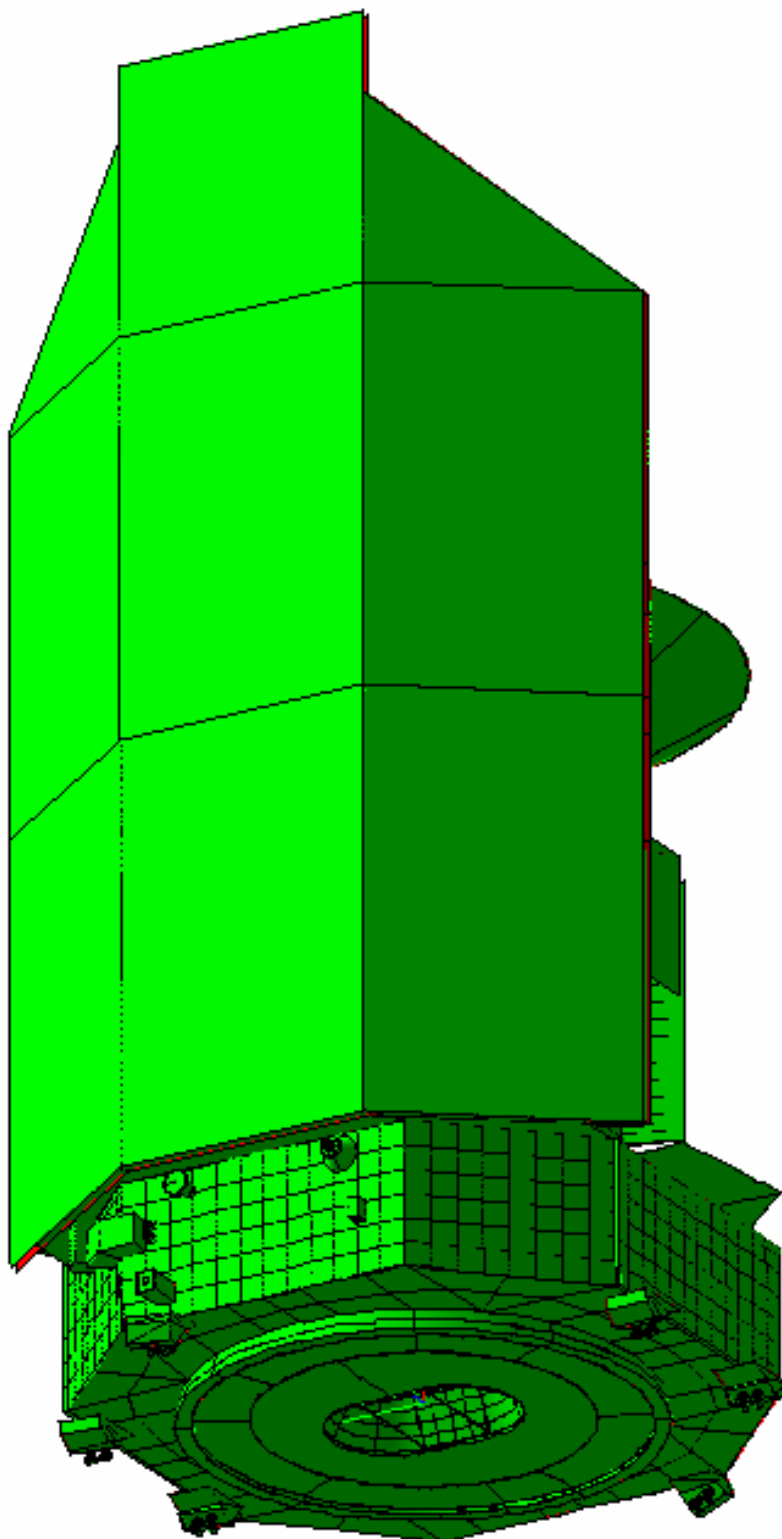

•  
Figure 3-1 HERSCHEL – Overall view +Z

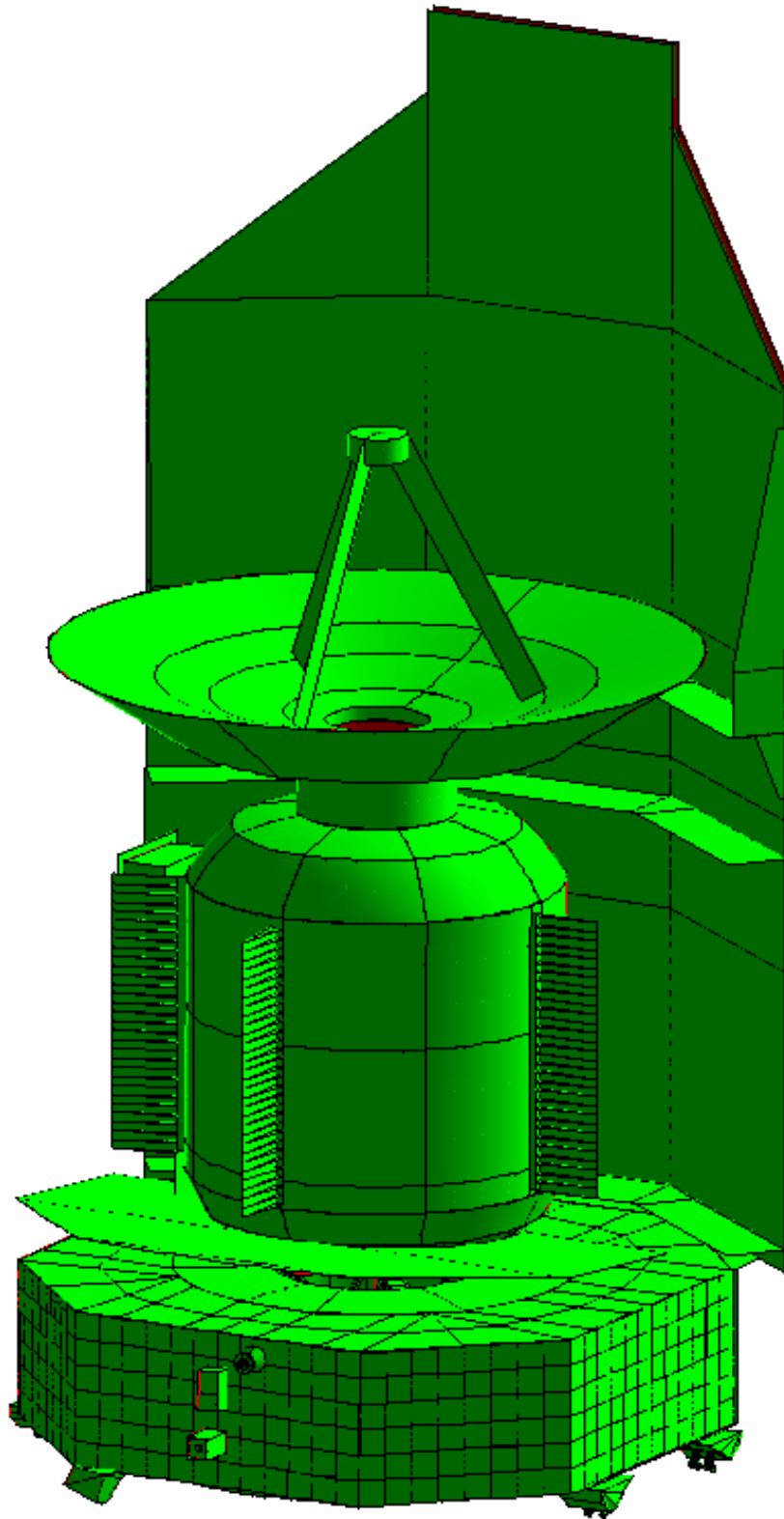

Figure 3-2 HERSCHEL – Overall view -Z



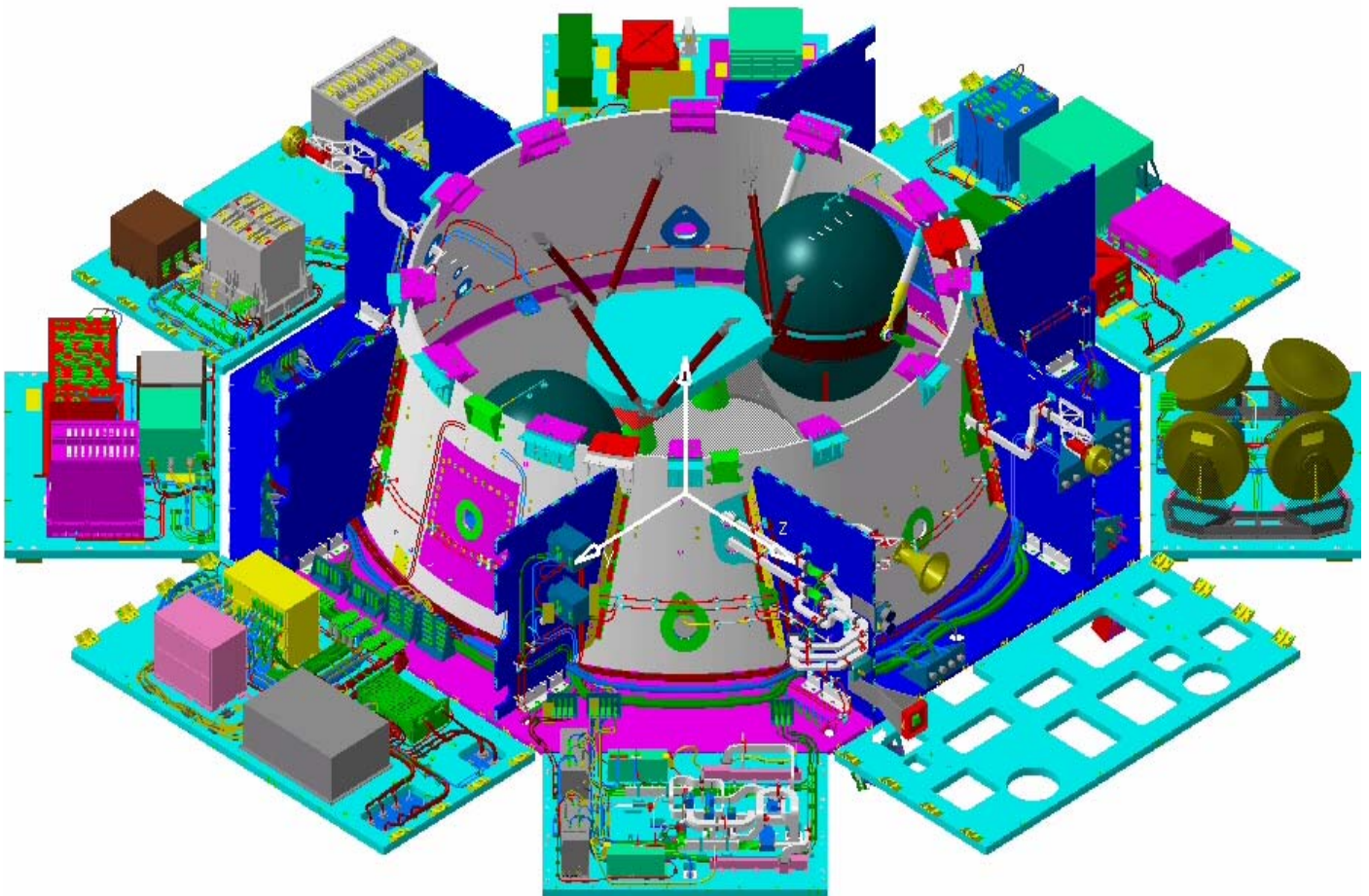

Figure 3-3 HERSCHEL – Internal overall View

### 3.1. HERSCHEL GMM and TMM update to Flight Configuration

Variations applied to GMM and TMM models due to the TV/TB test campaign and the model correlation activity, already reported in [AD29], are maintained for the Flight Analysis; in the following paragraphs, major modifications coming from the correlation activity will be summarized, and modifications due to the updated Flight Configuration will be highlighted too (reduced radiative area due to the IDB last issue).

### 3.1.1 HERSCHEL External GMM Variations

Major External GMM modifications are related to external MLI, STR, Thrusters, and the thermal-optical properties measured before the test campaign; for more details see [AD29].

- External MLI layout modifications

A general refinement of the external panels MLI nodes has been performed after TV/TB test campaign also considering the last issue of the HIFI units IDB; a list of the affected nodes is in the following table:

PANEL	AFFECTED NODES	ADDED/NEW NODES	GMM CONFIGURATION	
			Was	is
+Y+Z	4102 4103	-	BLACK MLI flat	BLACK MLI box
	3141 to 3148	4100	OSR	partially covered with BLACK MLI strip
	3108,3116,3124 3132,3140,3148	4106	OSR	partially covered with BLACK MLI strip
	3101,3109,3117 3125,3133,3141	4107	OSR	partially covered with BLACK MLI strip
+Z	4037	4103	BLACK MLI flat	BLACK MLI box to cover the waveguides
+Y-Z	3303	4303	Aeroglaze Z307	BLACK MLI
	3338	4338	Aeroglaze Z307	BLACK MLI
-Z	3415	4415-	Aeroglaze Z307	BLACK MLI
	3423	4423	Aeroglaze Z307	BLACK MLI
	3435	4435	Aeroglaze Z307	BLACK MLI
-Y-Z	4501	4501/3501	BLACK MLI	partially covered with BLACK MLI strip
	3502,3503,3504	4501	Aeroglaze Z307	partially covered with BLACK MLI strip
	3509,3517,3525	4501	Aeroglaze Z307	partially covered with BLACK MLI strip
	3536	4536	Aeroglaze Z307	partially covered with BLACK MLI
	3545	4545	Aeroglaze Z307	partially covered with BLACK MLI
	4541 to 4544 3545 to 3547 4548	4500	BLACK MLI/ Aeroglaze Z307	partially covered with BLACK MLI strip
-Y	3602,3614,3626, 3643,3654,3655	4602,4614,4626 , 4643,4654,4655	OSR	BLACK MLI
	3668,3669,3670	4668,4669,4670	OSR	BLACK MLI
	3638	4638	OSR	BLACK MLI
	4661,4662 3663 to 3667	4600	OSR/ BLACK MLI	partially covered with BLACK MLI

Table 3.1.1-1 HERSCHEL – External MLI modifications

A sketch of the updated Flight Configuration of external SVM panels is shown in Figure 3.1.1-1 (the drawing is viewed from +X axis and the panels are viewed from internal side, with the radiative areas projected on the internal panels. The outlining represents the MLI and white colour represents the radiative area), while a summary of the areas used in the current radiator layout is given in Table 3.1.1-2. The detailed MLI layout of the single panels is listed in Figures 3.1.1-2.

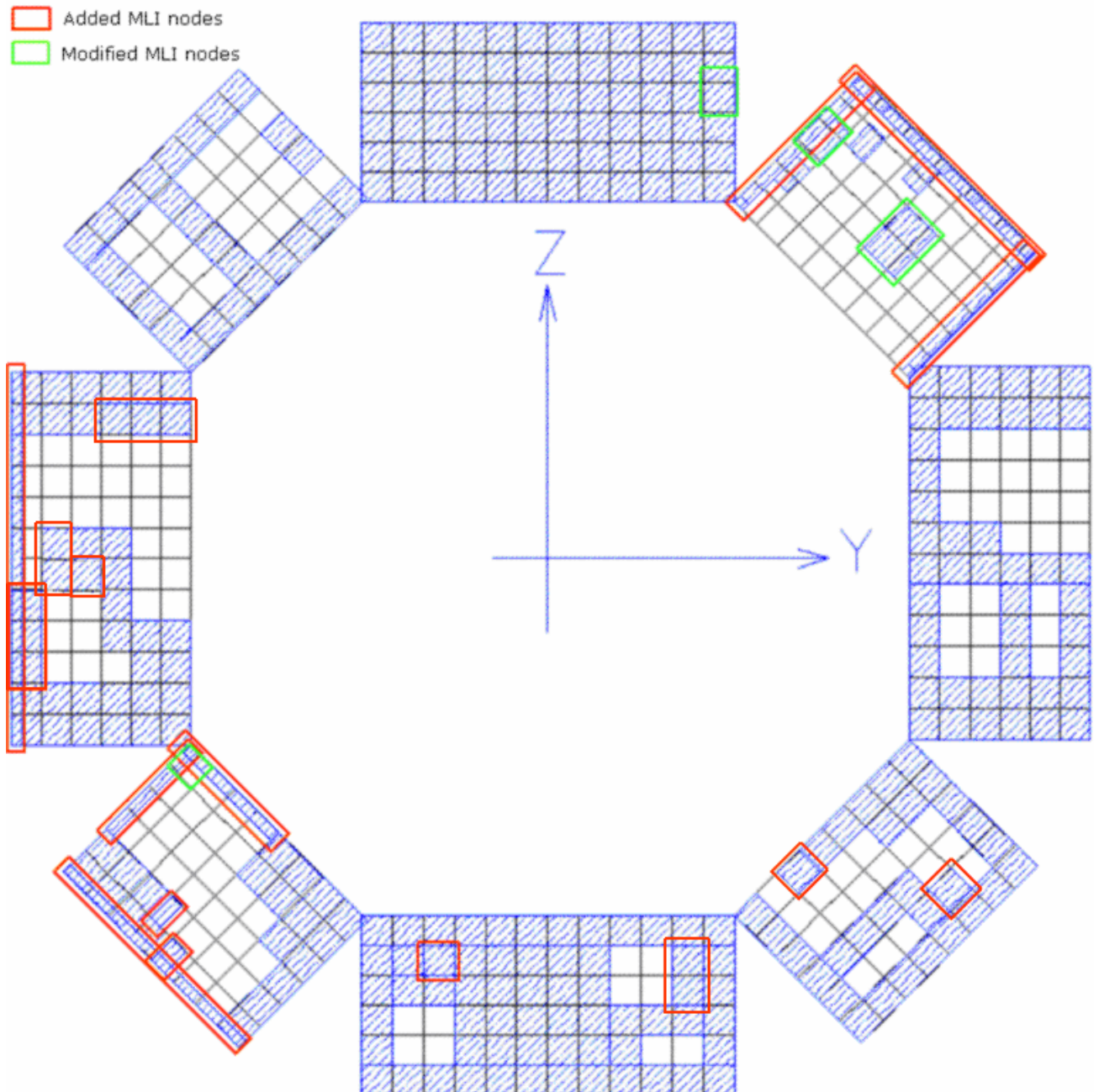

Figure 3.1.1-1 HERSHEL – SVM external panels radiators layout

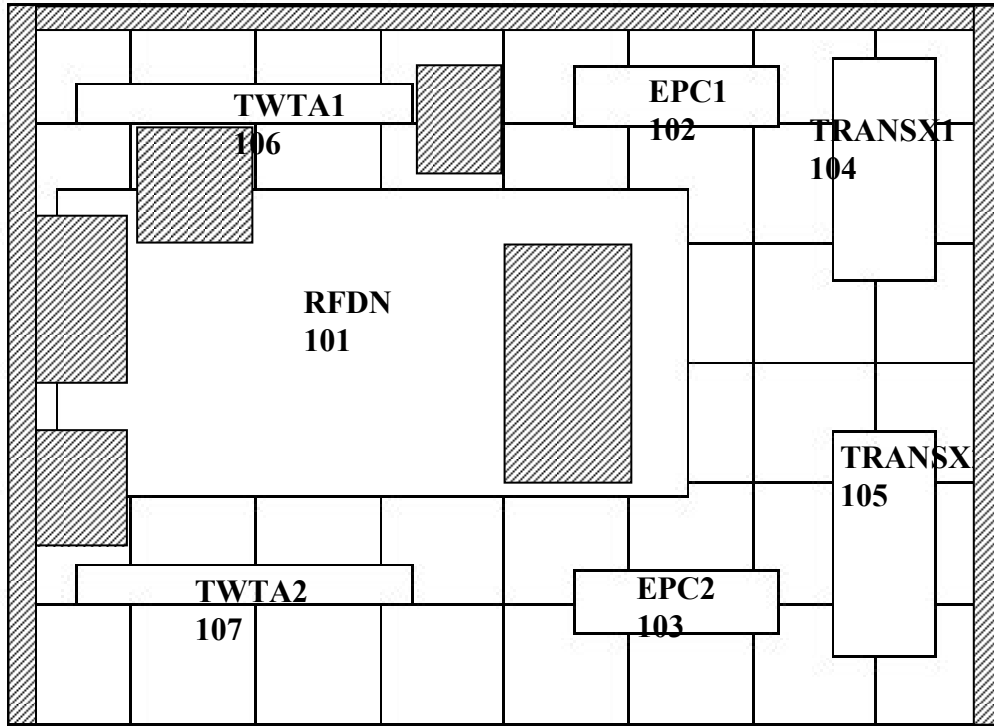

Figure 3.1.1-2a: HERSCHEL - +Y +Z MLI Lateral Panel & Units Internal View (See internal detail below)

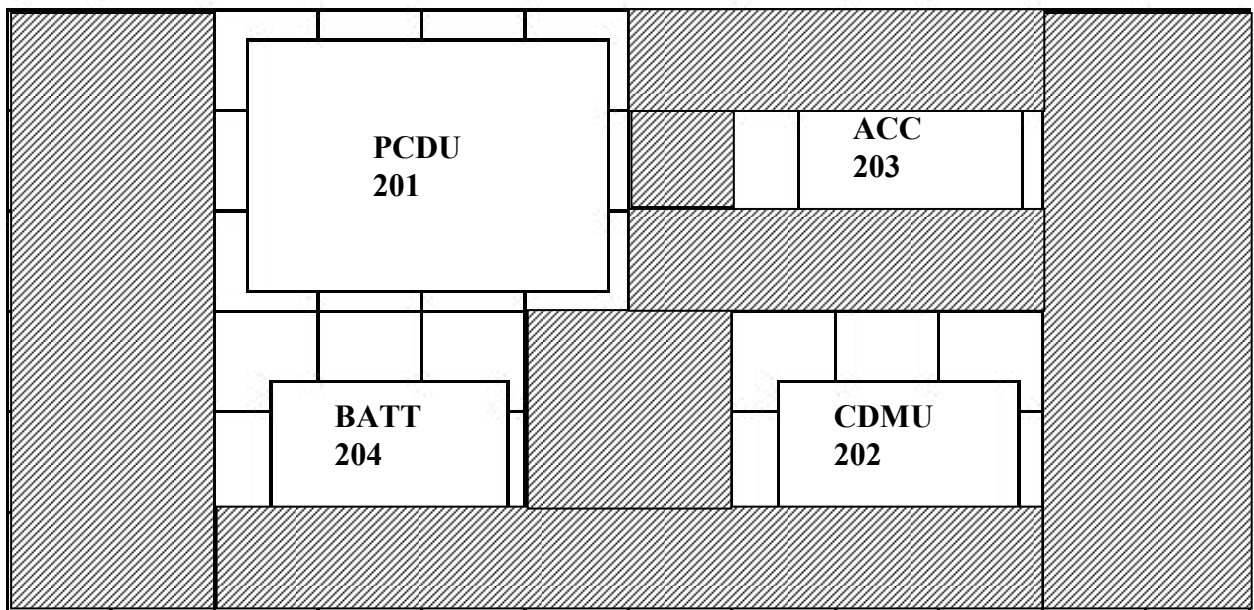

Figure 3.1.1-2b: HERSCHEL - +Y MLI Lateral Panel & Units Internal View

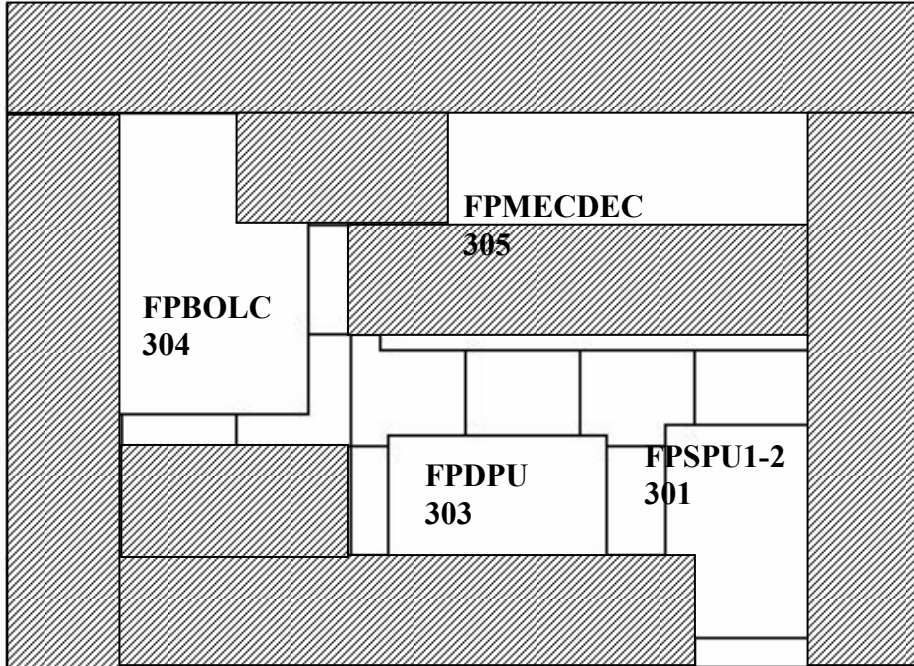

Figure 3.1.1-2c: HERSCHEL - +Y -Z MLI Lateral Panel & Units Internal View

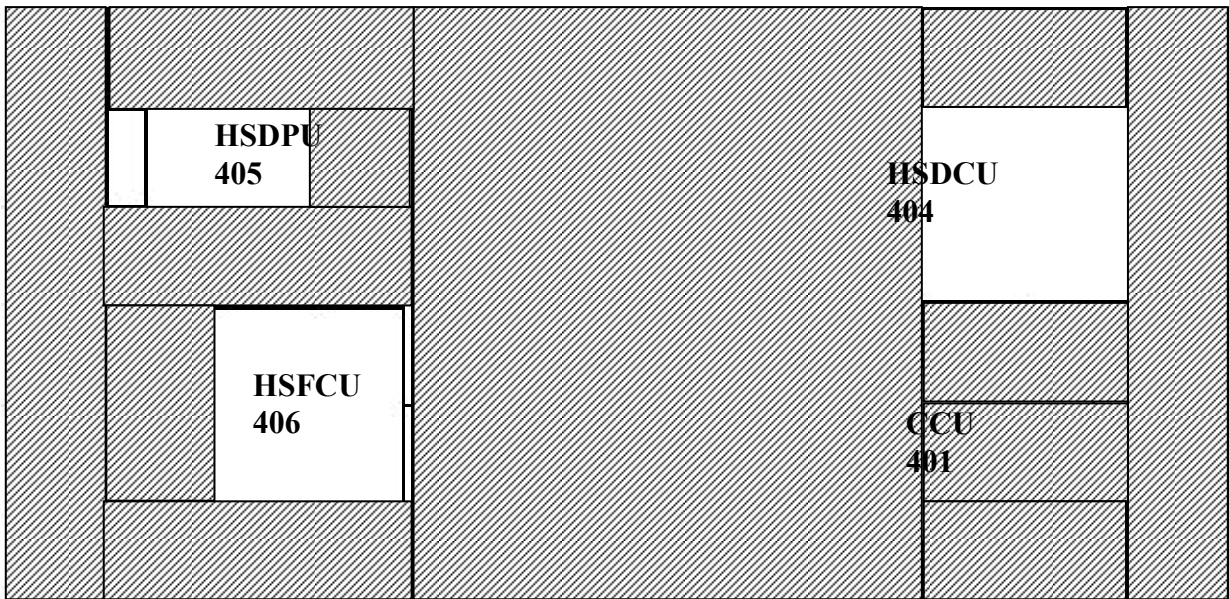

Figure 3.1.1-2d: HERSCHEL - -Z MLI Lateral Panel & Units Internal View

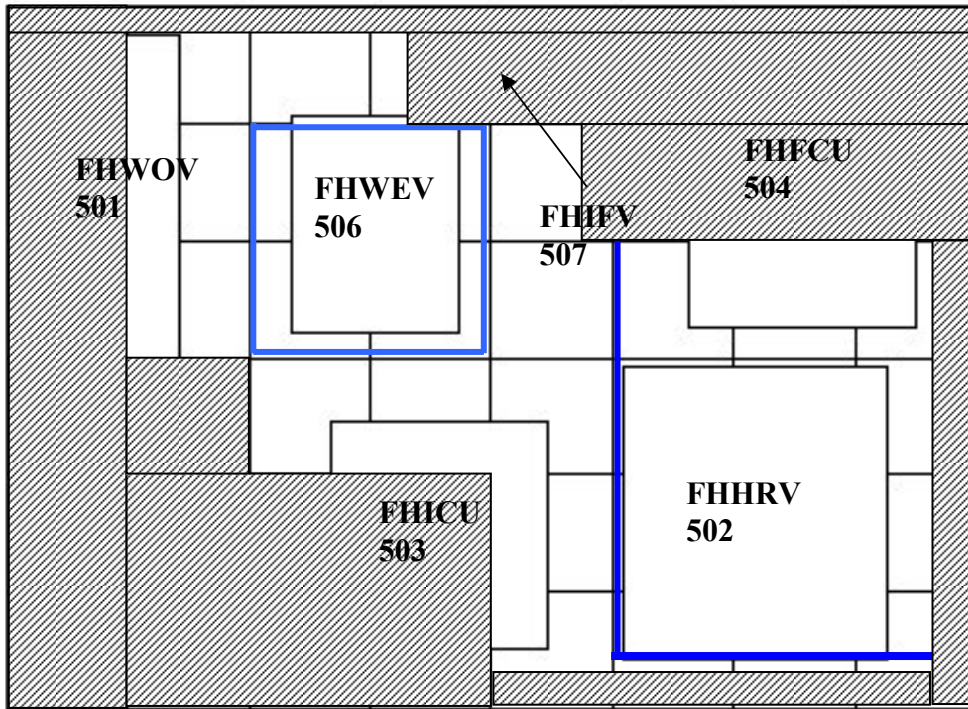

Figure 3.1.1-2e: HERSCHEL - -Y -Z MLI Lateral Panel & Units Internal View

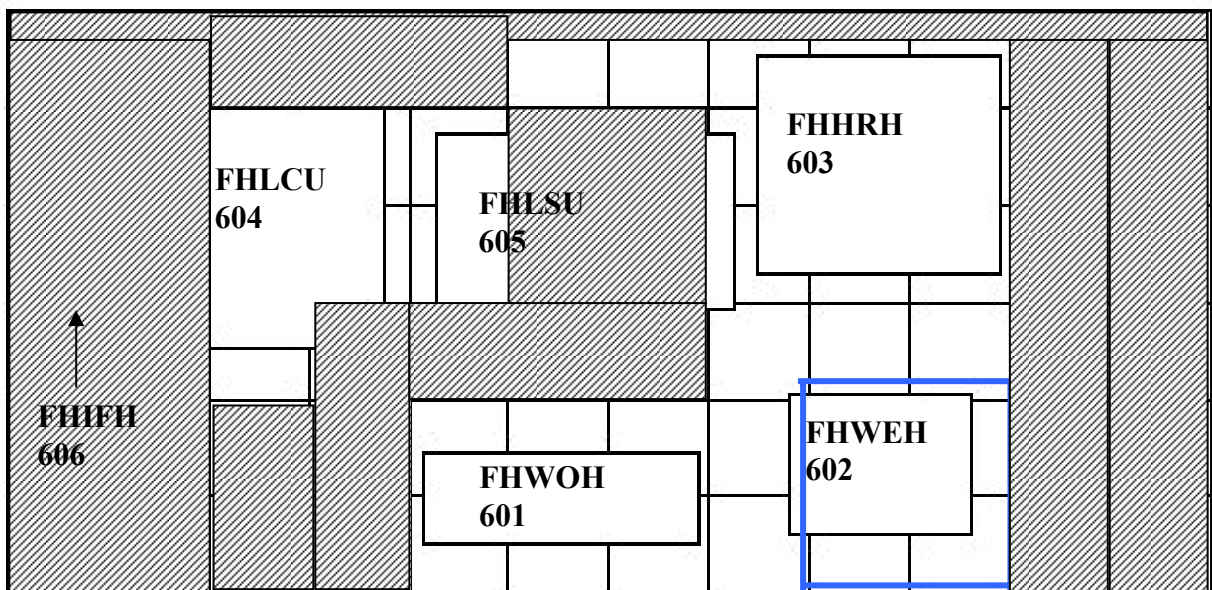

Figure 3.1.1-2f HERSCHEL - -Y MLI Lateral Panel & Units Internal View

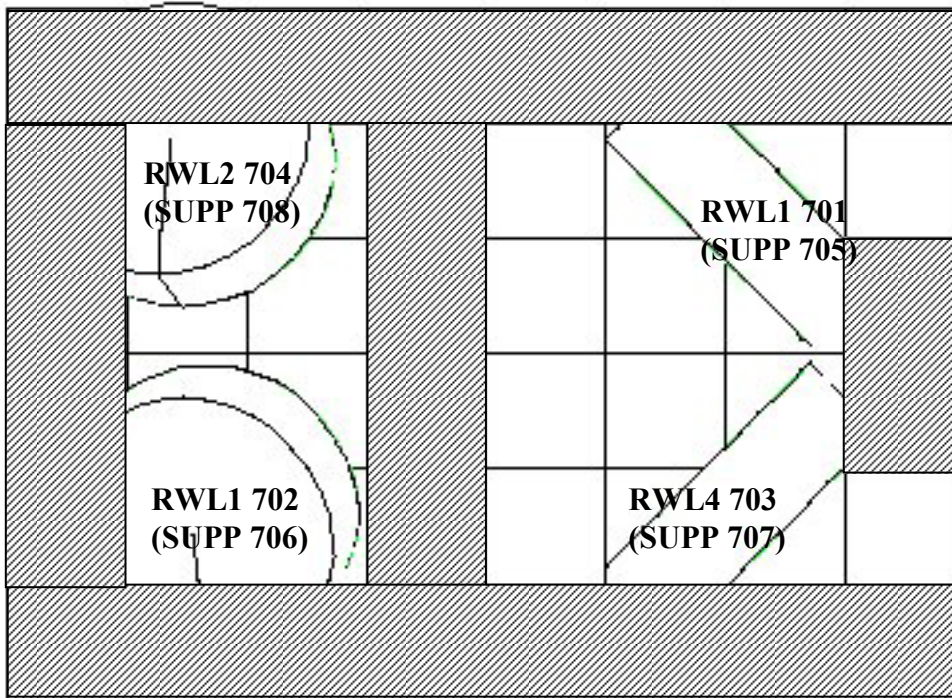

Figure 3.1.1-2g: HERSCHEL - -Y +Z MLI Lateral Panel & Units Internal View



<b>SVM RADIATORS AREAS</b>							
<b>[m<sup>2</sup>]</b>							
<b>CDR</b>				<b>POST TEST STM</b>			
Lateral Panels	Total Area	Radiative area	MLI Area	Lateral Panels	Total Area	Radiative area	MLI Area
+Z	1.462	0.000	1.462	+Z	1.462	0.000	1.462
+Y+Z	0.974	0.869	0.105	+Y+Z	0.974	0.731	0.244
+Y	1.462	0.548	0.914	+Y	1.462	0.548	0.914
+Y-Z	0.974	0.386	0.588	+Y-Z	0.974	0.345	0.626
-Z	1.462	0.264	1.198	-Z	1.462	0.203	1.259
-Y-Z	0.974	0.548	0.426	-Y-Z	0.974	0.505	0.469
-Y	1.462	0.873	0.589	-Y	1.462	0.592	0.870
-Y+Z	0.974	0.447	0.527	-Y+Z	0.974	0.446	0.528
<b>TOTAL</b>	<b>9.744</b>	<b>3.935</b>	<b>5.809</b>	<b>TOTAL</b>	<b>9.744</b>	<b>3.37</b>	<b>6.37</b>

Table 3.1.1-2 HERSCHEL – SVM radiators areas updated

- Thrusters modifications

A more detailed thrusters model has been introduced for the TV/TB test campaign and the related correlation activity; for each of the six thruster groups, a new model composed by the body of the main and the redundant thruster, their support bracket, and the MLI box covering the entire assembly has been build. This local model is shortly described hereafter, as well as the minor GMM modifications introduced for the Flight Configuration. For more details, see [AD29] and the following figures:

GMM NODE NUMBER	LABEL	BOL PROPERTIES		Configuration	
		$\alpha$	$\epsilon$	TV/TB	FLIGHT
8X01 (*)	NOZZLE	0.50	0.35	✓	✓
8X02 (*)	DEC. CHAMBER	0.50	0.70	✓	✓
8X03 (*)	EXT. INSULATION	0.50	0.12	X	✓
8X05 (*)	HEAT BARRIER DOWN	0.50	0.30	✓	✓
8X06 (*)	HEAT BARRIER MID	0.50	0.30	✓	✓
8X07 (*)	HEAT BARRIER UP	0.50	0.30	✓	✓
8X08 (*)	HEAT BARR. FLANGE	0.50	0.30	✓	✓
8X09 (*)	FCV FLANGE I/F	0.50	0.30	✓	✓
8X10 (*)	ADJUSTMENT RING	0.50	0.60	✓	✓
8X11 (*)	TURNING DISC	0.50	0.60	✓	✓
8X35 (*)	HEATERS ELECTR. CONNECT.	0.50	0.60	✓	✓
8X36 (*)	HEATERS ELECTR. CONNECT.	0.50	0.60	✓	✓
8X37 (*)	HEATERS ELECTR. CONNECT.	0.50	0.60	✓	✓
8X38 (*)	HEATERS ELECTR. CONNECT.	0.50	0.60	✓	✓
8X43 (*)	DEC. CHAMBER HEATER	0.50	0.70	✓	✓
8X44 (*)	DEC. CHAMBER HEATER	0.50	0.70	✓	✓
8X32	SUPPORT BRACKET	0.40	0.20	✓	✓
8X33	FCV BODY, MAIN	0.50	0.60	✓	✓
8X34	FCV BODY, REDUNDANT	0.50	0.60	✓	✓
8X46	EXT MLI BOX	0.92	0.86	✓	✓
8X47	INT MLI BOX	0.13	0.05	✓	✓

(\*) node numbering for main thruster; add 20 for redundant thruster

Table 3.1.1-3 HERSCHEL – Thrusters GMM

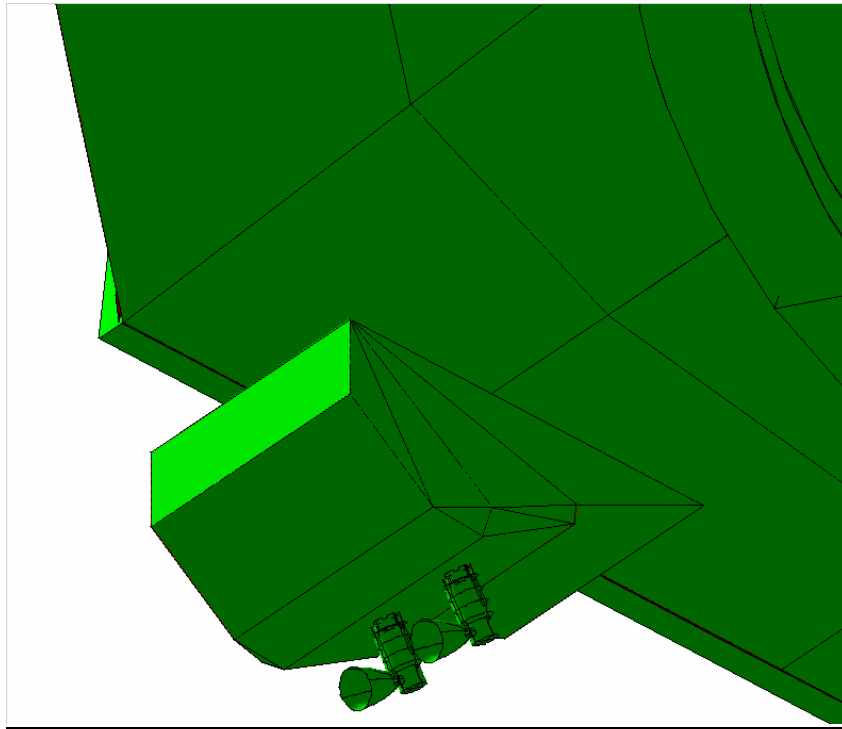

Figure 3.1.1-3 HERSCHEL – Thruster external view, Flight Configuration without external insulators

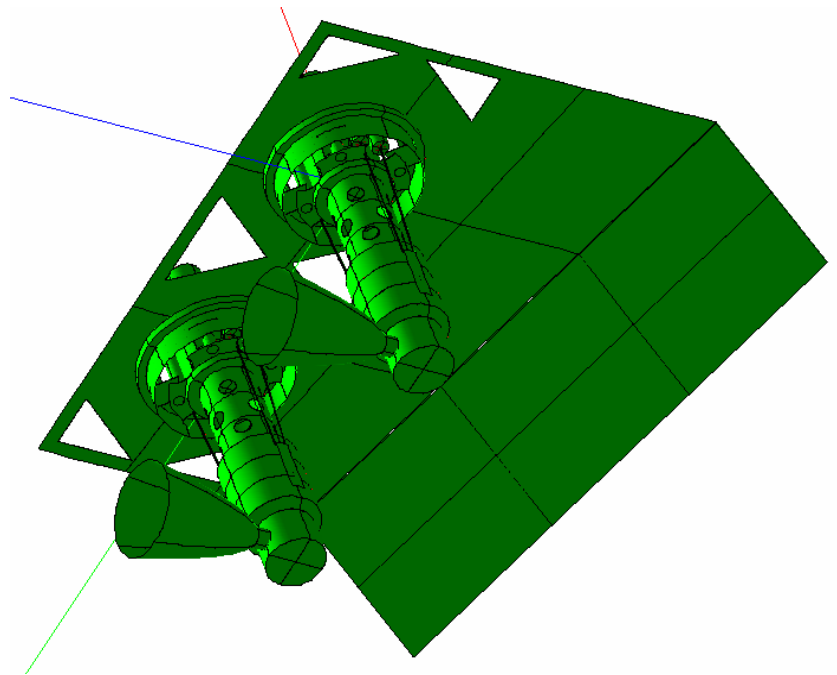
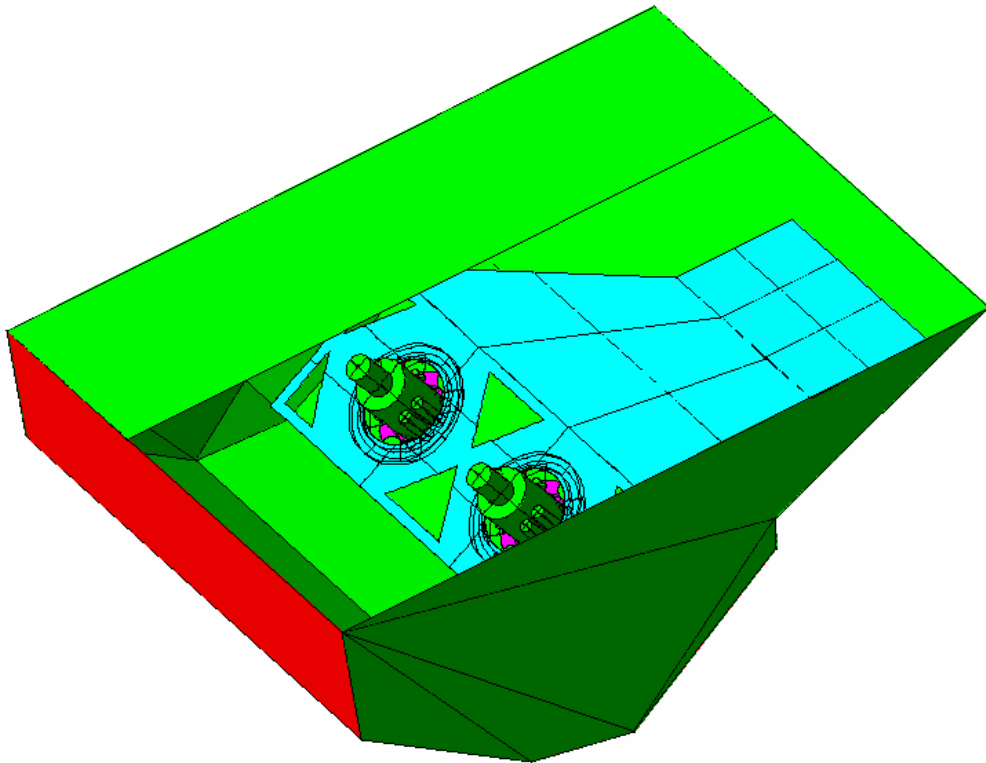

Figure 3.1.1-4 HERSCHEL – Thruster external view, TV/TB Configuration without external insulators



---

Figure 3.1.1-5 HERSCHEL – Thruster internal view

- Thermal-optical Properties

The thermal-optical properties of external surfaces in the GMM have been modified after a measurement campaign, according to [AD30] and [AD29]; modifications due to the update to the Flight Configuration and due to the HIFI IDB last issue, are highlighted in the Table 3.1.1-4:

SURFACES	MATERIALS	$\alpha$ BOL	$\alpha$ EOL	$\epsilon$	Reference
<b>GMM INTERNAL</b>					
Units, Internal panels	Aeroglaze Z306			0.87	ALS
Internal Panels -Y-Z, -Y	Aluminium			0.05	ALS
FPDPU/HSDPU	Alodine			0.172	ICD Data (AD9)
FHICU				0.85	HIFI IIDB 3.3
FHFCU				0.91	HIFI IIDB 3.3
FHLSU				0.87	HIFI IIDB 3.3
Battery				0.30	Average $\epsilon$ value
CCU	Alodine			0.2	ICD Data (AD9)
FHWOV/FHWOH	Aluminium			0.05	ALS
HRV/WEV/WEH/HRH/LCU	Black paint			0.8	ICD Data (AD9)
FH3DV/FH3DH	Goldized			0.05	ICD Data (AD9)
LV1/LV2/LF	Aluminium Tape (titanium)			0.05	ALS
PT	Aluminium Tape (steel)			0.05	ALS
FHWIH IF cables	Kapton Tape			0.7	ALS assumption
CFRP Surfaces (Bottom Floor, Top Floor, Shear Panels & Cone)	CFRP			0.87	ALS
Internal Launcher Adaptor Ring	Aluminium Tape			0.05	ALS
Internal MLI (-Y Panel, -Y-Z Panel, Internal STR baffle, Tanks)	VDA Kapton (Aluminized)			0.05	ALS
Bottom closure internal side	1/3 CFRP – 2/3 VDA Kapton (Aluminized)			0.33	Average $\epsilon$ value
<b>GMM EXTERNAL</b>					
VMC lens		0.9	=	0.9	ALS Assumption
SREM		0.52	=	0.12	Integral data
SAS housing/pyramid		0.96	=	0.83	HP-4-TNO-RP-S004
SAS chip		0.9	=	0.82	HP-4-TNO-RP-S004
MGA / LGA	Alodine 1200 S	0.46	=	0.1	HP-AN-RY-0020-21
MGA	Germanium	0.6	=	0.72	HP-AN-RY-0021
LGA	White paint	0.6	=	0.88	HP-AN-RY-0020
AAD top surface		0.96	=	0.83	HP-4-TNO-RP-A004
AAD chip		0.9	=	0.013	HP-4-TNO-RP-A004
External Launcher Adaptor Cone	Cromic Acid/Aluminium	0.218	=	0.066	Test Measurement
External Launcher Adaptor Edge	Alodine/Aluminium	0.220	=	0.066	Test Measurement
Lat Panels +Y+Z, +Y, -Y, -Y+Z, STR	OSR	0.1	0.18	0.82	Test Measurement
Others Lat Panels	Aeroglaze Z307	0.97	=	0.88	Test Measurement
MLI to HPLM and MLI truss to CVV	VDA Kapton (Aluminized)	0.15	=	0.05	ALS
External STR secondary baffle	Silver Teflon Tape	0.04	0.24	0.80	Specularity=65% Test Measurement
External MLI (Bottom Floor, Launcher Adaptor, Radiator Panels, External units, STR radiator unit and baffle)	Carbon Filled Kapton	0.94	=	0.85	Test Measurement

Table 3.1.1-4 HERSCHEL – SVM thermal-optical properties

3.1.2 HERSCHEL Internal GMM Variations

Major Internal GMM modifications are related to HIFI Panels and TT&C Panel and units:

- HIFI Panels modifications  
Both for HIFI Short Panel and for HIFI Long Panel, GMM has been modified introducing an increased detail near FHWOH and FHWOV respectively; Table 3.1.2-1 provides the new node numbering, while in Figures 3.1.2-1 and 3.1.2-2 a detail of the new mesh is shown.

PANEL	UNIT	PANEL NODES (*)		UNIT NODES	
		was	is	was	is
SHORT	FHWOV	X531	X53101 to X53116	501: case 521: baseplate	501: MLI 521: baseplate 531: case
		X532	X53201 to X53216		
		X539	X53901 to X53916		
		X540	X54001 to X54016		
		X547	X54701 to X54716		
		X548	X54801 to X54816		
LONG	FHWOH	X606	X60601 to X60616	601: case 621: baseplate	601: MLI 621: baseplate 631: case
		X607	X60701 to X60716		
		X608	X60801 to X60816		
		X618	X61801 to X61816		
		X619	X61901 to X61916		
		X620	X62001 to X62016		

(\*) Node numbering: X=6 for internal nodes, X=3 for external nodes

Table 3.1.2-1 HERSCHEL – HIFI Panels GMM

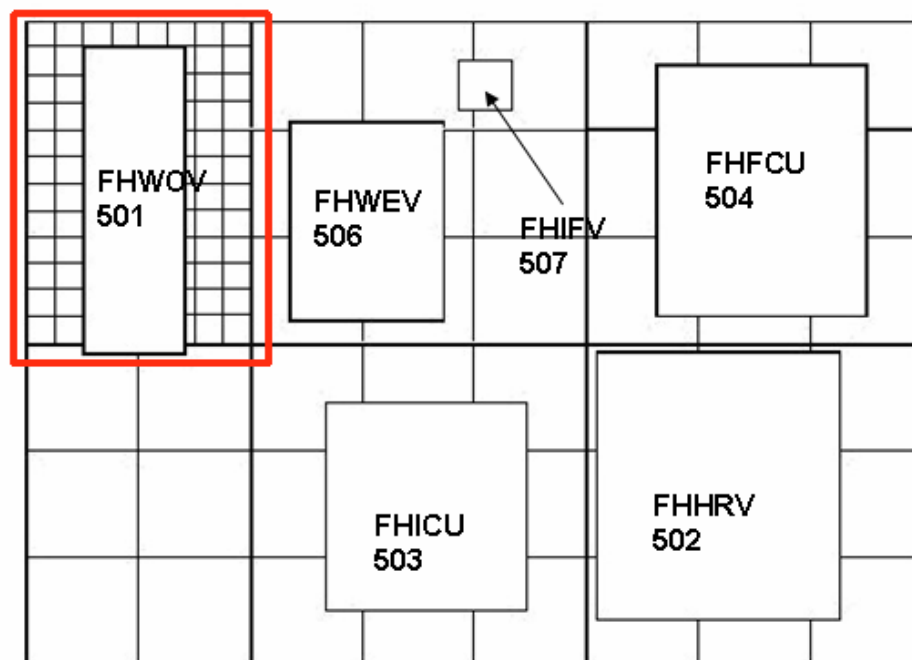

Figure 3.1.2-1 HERSCHEL – HIFI Short Panel new local mesh

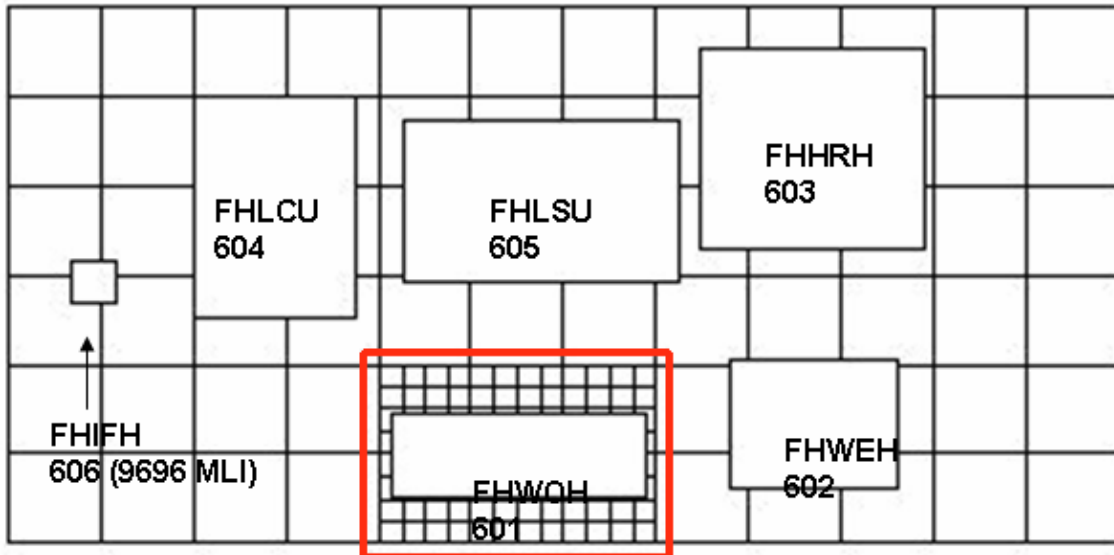

Figure 3.1.2-2 HERSCHEL – HIFI Long Panel new local mesh

A dedicated calculation of radiative coupling between the new mesh nodes and the unit baseplates has been performed; a sketch of the old and the new models of FHWOV and FHWOV is depicted in Figures 3.1.2-3 and 3.1.2-4:

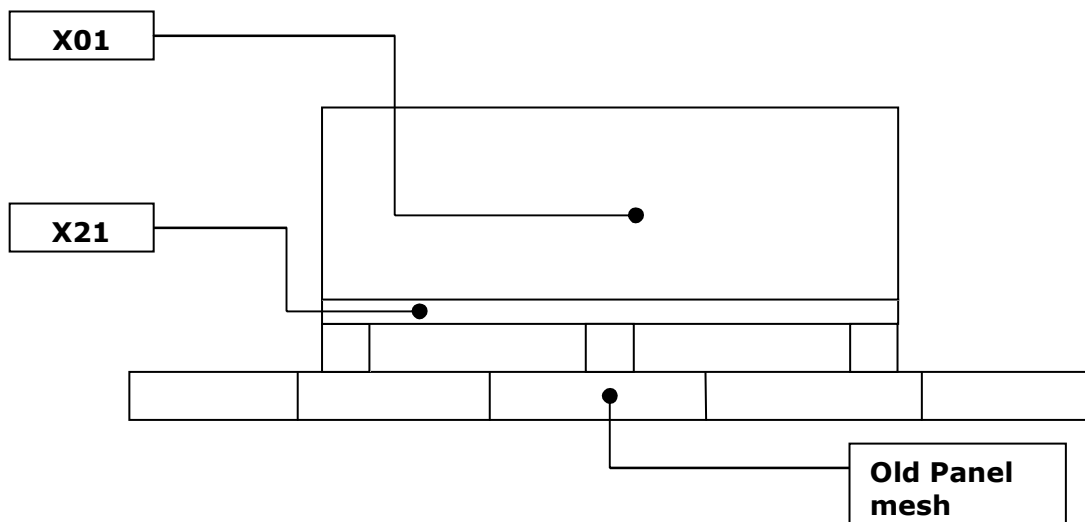

Figure 3.1.2-3 HERSCHEL – FHWOV/FHWOH old model

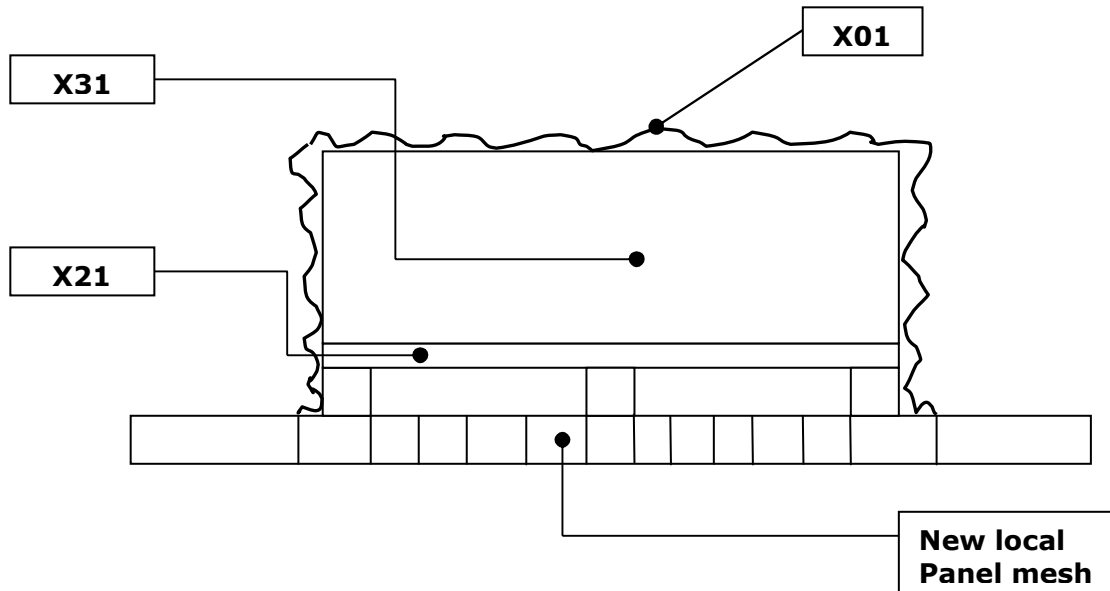

Figure 3.1.2-4 HERSCHEL – FHWOV/FHWOH new model



- TWT Unit and doubler modifications

The TWT and TWT doubler GMM, have been modified introducing an increased detail on TWT doubler and unit; Table 3.1.2-2 provides the new node numbering, while in Figures 3.1.2-5 and 3.1.2-6 a detail of the new mesh is shown.

PANEL	UNIT	DOUBLER NODES		UNIT NODES	
		was	is	was	is
+Y +Z	TWT1	6149 to 6151	6149 to 6151 & 6161 to 6167	106: case	136: HEAD case 146: HEAD baseplate 106: BODY case 126: BODY baseplate
+Y +Z	TWT2	6152 to 6154	6152 to 6160 & 6168	107 case	137: HEAD case 147: HEAD baseplate 107: BODY case 127: BODY baseplate

Table 3.1.2-2 HERSCHEL – TWT Panel and units GMM remodelisation

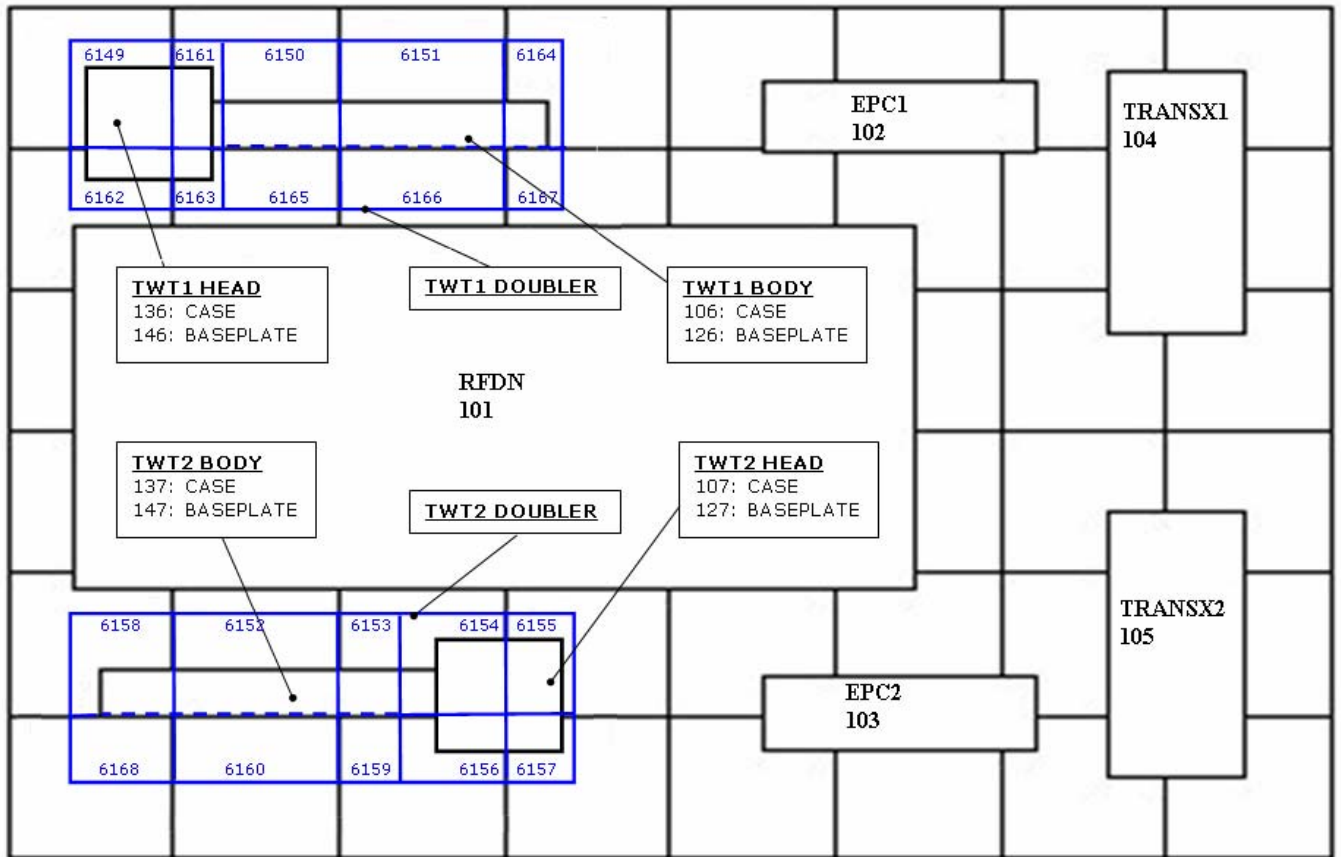

Figure 3.1.2-5 HERSCHEL – TT&C doublers new local mesh

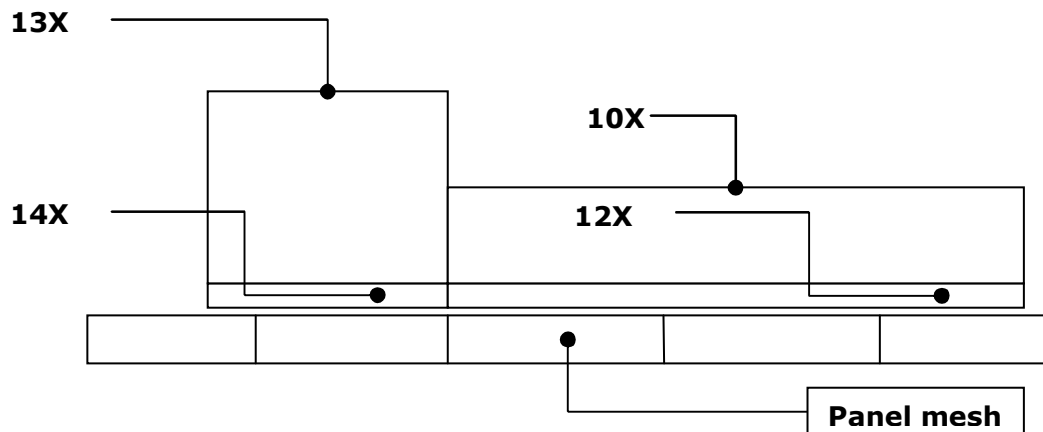

Figure 3.1.2-6 HERSCHEL – TWT1 (X=6) / TWT2 (X=7) new model

## HERSCHEL TMM Variations

Major TMM modifications described in [AD29] are related to HIFI and TT&C Panels and units and to thrusters:

- HIFI Panels and Units modifications

Accordingly to modifications described in Par. 3.1.2, a general update of the conductive couplings has been performed, mainly regarding FHWOV/FHWOH units and underlying panel nodes (see Figures 3.1.2-3 and 3.1.2-4). The current status is presented in Table 3.1.3-1:

PANEL	UNIT	UNIT-PANEL COUPLINGS			UNIT CONDUCTORS [W/K]	
		was	is	GL [W/K ]	was	is
SHORT	FHWOV	521, 6531	521, 653102	0.071	(521, 501) = 9.88	(531, 521) = 9.88 (531, 501) = 0.01936
		521, 6540	521, 654008	0.071		
		521, 6547	521, 654710	0.071		
LONG	FHWO H	621, 6607	621, 660706	0.071	(621, 601) = 9.88	(631, 621) = 9.88 (631, 601) = 0.01936
		621, 6618	621, 661810	0.071		
		621, 6620	621, 662011	0.071		

Table 3.1.3-1 HERSCHEL – HIFI Panels TMM

- TT&C Panels and Units modifications

Accordingly to modifications described in Par. 3.1.2, a general update of the conductive couplings has been performed, mainly regarding TWT units and underlying panel nodes (see Figures 3.1.2-5 and 3.1.2-6). The current status is presented in Table 3.1.3-2:

PANEL	UNIT	UNIT-PANEL COUPLINGS			UNIT CONDUCTORS [W/K]	
		was	is	GL [W/K ]	was	is
+Y+Z	TWT1	106, 6149, 6150, 6151	126, 6150, 6151,6164, 6165,6166, 6167	6.09/2	Only one node	(126, 146) = 1.6 (106, 126) = 35 (136, 146) = 35
			146, 6149, 6161,6162, 6163	6.09/2		
	TWT2	107, 6152, 6153, 6154	127, 6158, 6152,6153, 6168,6160, 6159	6.09/2		
			147, 6154, 6155,6156, 6157	6.09/2		

Table 3.1.3-2 HERSCHEL – TT&amp;C Panels TMM

- Thrusters modifications

The thermal model of the thrusters is the same used for XMM and INTEGRAL programs, and it is unchanged; the nodal breakdown is shown in Table 3.1.3-2, while in Table 3.1.3-3 is reported the current status of thruster support brackets-bottom floor coupling.

TMM NODE NUMBER	LABEL	MATERIAL	Configuration	
			TV/T B	FLIGH T
8X01 (*)	NOZZLE	HAYNES 25	√	√
8X02 (*)	DEC. CHAMBER	STAINL. STEEL	√	√
8X03 (*)	EXT. INSULATOR	STAINL. STEEL	X	√
8X04 (*)	HEAD PLATE	HAYNES 25	X	√
8X05 (*)	HEAT BARRIER DOWN	HAYNES 25	√	√
8X06 (*)	HEAT BARRIER MID	HAYNES 25	√	√
8X07 (*)	HEAT BARRIER UP	HAYNES 25	√	√
8X08 (*)	HEAT BARR. FLANGE	HAYNES 25	√	√
8X09 (*)	FCV FLANGE I/F	STAINL. STEEL	√	√
8X10 (*)	ADJUSTMENT RING	STAINL. STEEL	√	√
8X11 (*)	TURNING DISC	STAINL. STEEL	√	√
8X35 (*)	HEATERS ELECTR. CONNECT.	STAINL. STEEL	√	√
8X36 (*)	HEATERS ELECTR. CONNECT.	STAINL. STEEL	√	√
8X37 (*)	HEATERS ELECTR. CONNECT.	STAINL. STEEL	√	√
8X38 (*)	HEATERS ELECTR. CONNECT.	STAINL. STEEL	√	√
8X43 (*)	DEC. CHAMBER HEATER	KAPTON	√	√
8X44 (*)	DEC. CHAMBER HEATER	KAPTON	√	√
8X32	SUPPORT BRACKET	STAINL. STEEL	√	√
8X33	FCV BODY, MAIN	STAINL. STEEL	√	√
8X34	FCV BODY, REDUNDANT	STAINL. STEEL	√	√
8X46	EXT MLI BOX	MLI 20 LAYER	√	√
8X47	INT MLI BOX	MLI 20 LAYER	√	√

(\*) node numbering for main thruster; add 20 for redundant thruster

Table 3.1.3-3 HERSCHEL – Thrusters TMM

<b>THRUSTER</b>	<b>Bracket Node</b>	<b>Bottom Floor Node</b>	<b>GL [W/K]</b>
<b>A1</b>	8132	1608 1612	0.8 0.8
<b>A2</b>	8432	1654	1.6
<b>C1</b>	8332	1628	1.6
<b>C2</b>	8232	1622	1.6
<b>C3</b>	8632	1668	1.6
<b>C4</b>	8532	1662	1.6

Table 3.1.3-4 HERSCHEL – Thrusters brackets/Bottom Floor linear couplings

All the thrusters have now 4 copper straps, the design is the same for the six couple of thrusters.

- MLI conductivity modifications

See para 5.1.

- Panel conductivity modifications

See para 5.3

- Unit – Panel conductivity modifications

See para 3.1.7

### 3.1.3 HERSCHEL RCS Model Variations

A new RCS pipelines model has been introduced for TV/TB Test; it is made of 140 nodes (132 for piping, 4 for RCS units and 4 for the MLI on the RCS units). Each typical pipeline node is centered on the relevant pipeline support; a summary of linear and radiative couplings to structure is given in Table 3.1.4-1. In particular for the units, the grounding design has been modified to reduce the linear conductors vs the structure nodes.

<b>Linear Coupling</b>	<b>RCS Nodes</b>	<b>GL [W/K]</b>	<b>remarks</b>
<b>Single RCS line / Structure</b>	<b>1400 to 1599</b>	0.004	Local variations for nodes near +Z valves and shear panels
<b>Double RCS Line / Structure</b>		0.007	
<b>RCS line / tanks</b>		0.007	
<b>RCS line / Thrusters FCV</b>		0.01	
<b>LV / -Z+Y shear panel</b>	<b>1477, 1482</b>	0.0428	
<b>LF / -Z+Y shear panel</b>	<b>1400</b>	0.0193	
<b>PT / -Z+Y shear panel</b>	<b>1487</b>	0.0317	
<b>Radiative Coupling</b>	<b>RCS Nodes</b>	<b>GR [W/K<sup>4</sup>]</b>	<b>remarks</b>
<b>Single RCS line, 20 cm / Structure</b>	<b>1400 to 1599</b>	2.49E-11	Local variations for nodes near tanks
<b>Single RCS line, 30 cm / Structure</b>		3.74E-11	
<b>Single RCS line, 45 cm / Structure</b>		5.80E-11	
<b>Double RCS line, 20 cm / Structure</b>		4.98E-11	
<b>Double RCS line, 30 cm / Structure</b>		7.48E-11	

Table 3.1.4-1 HERSCHEL – RCS model summary

The RCS geometrical model has been modified according to the following figures:

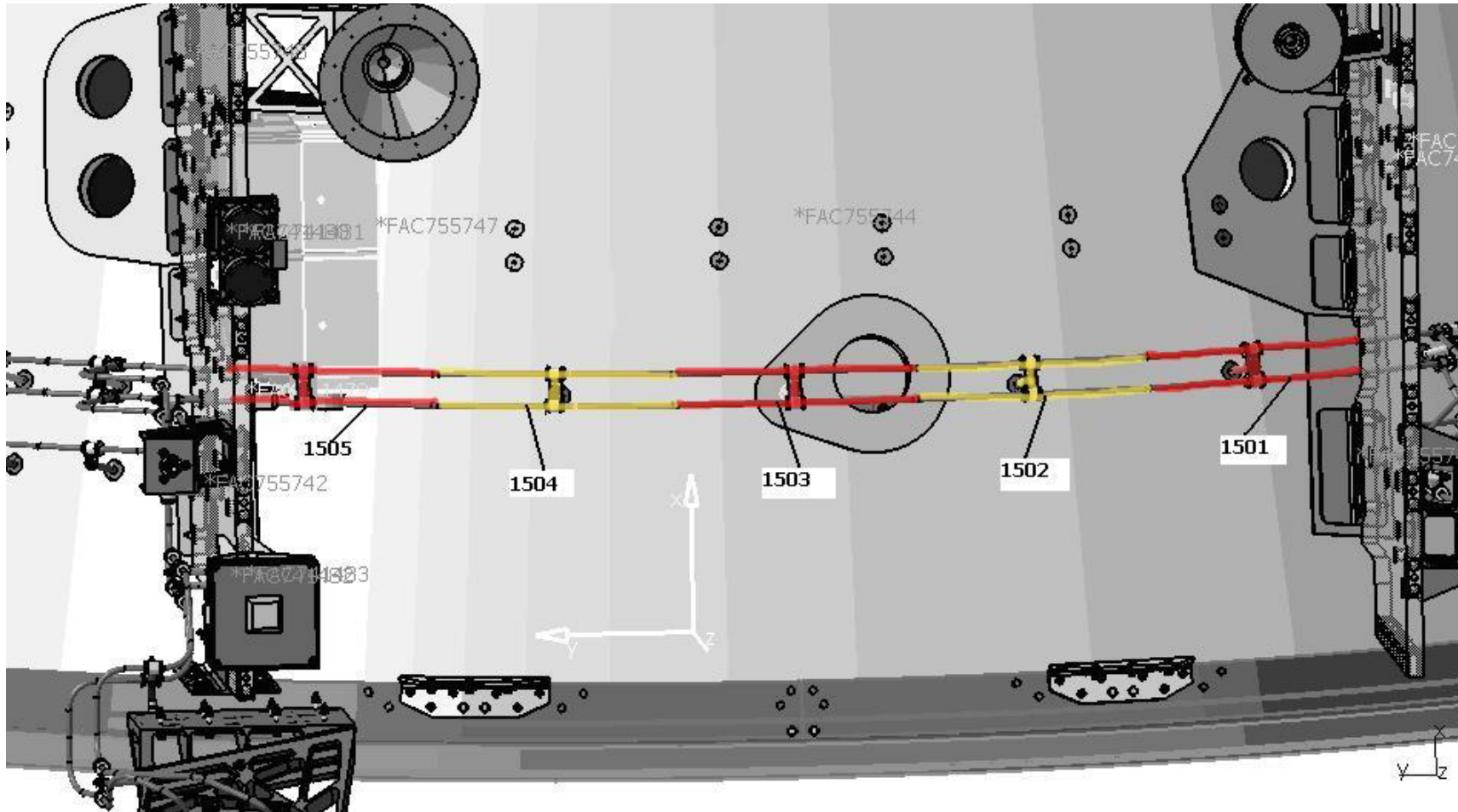

Figure 3.1.4-1 HERSHEL – RCS line9

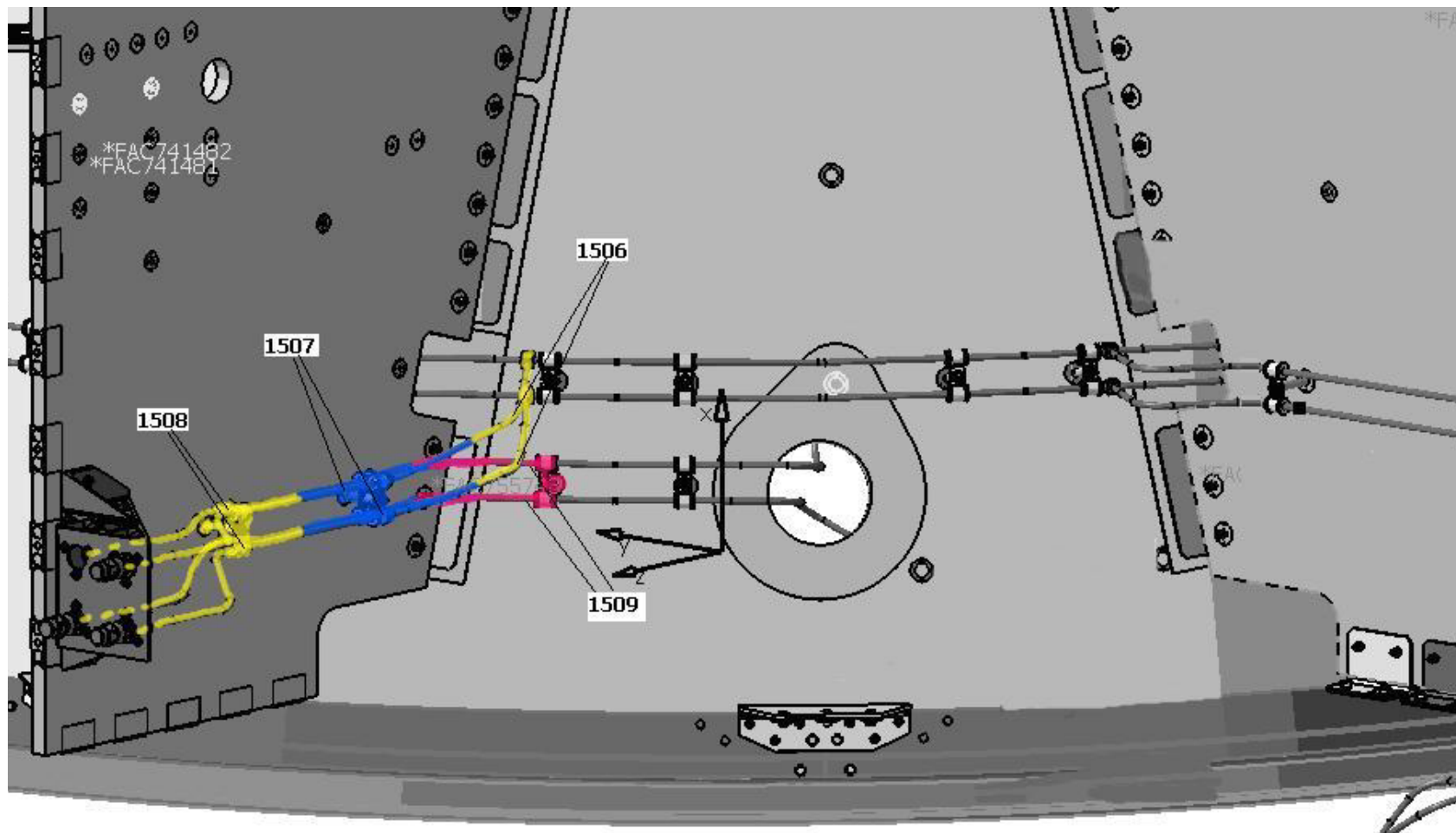

Figure 3.1.4-2 HERSCHEL – RCS line9



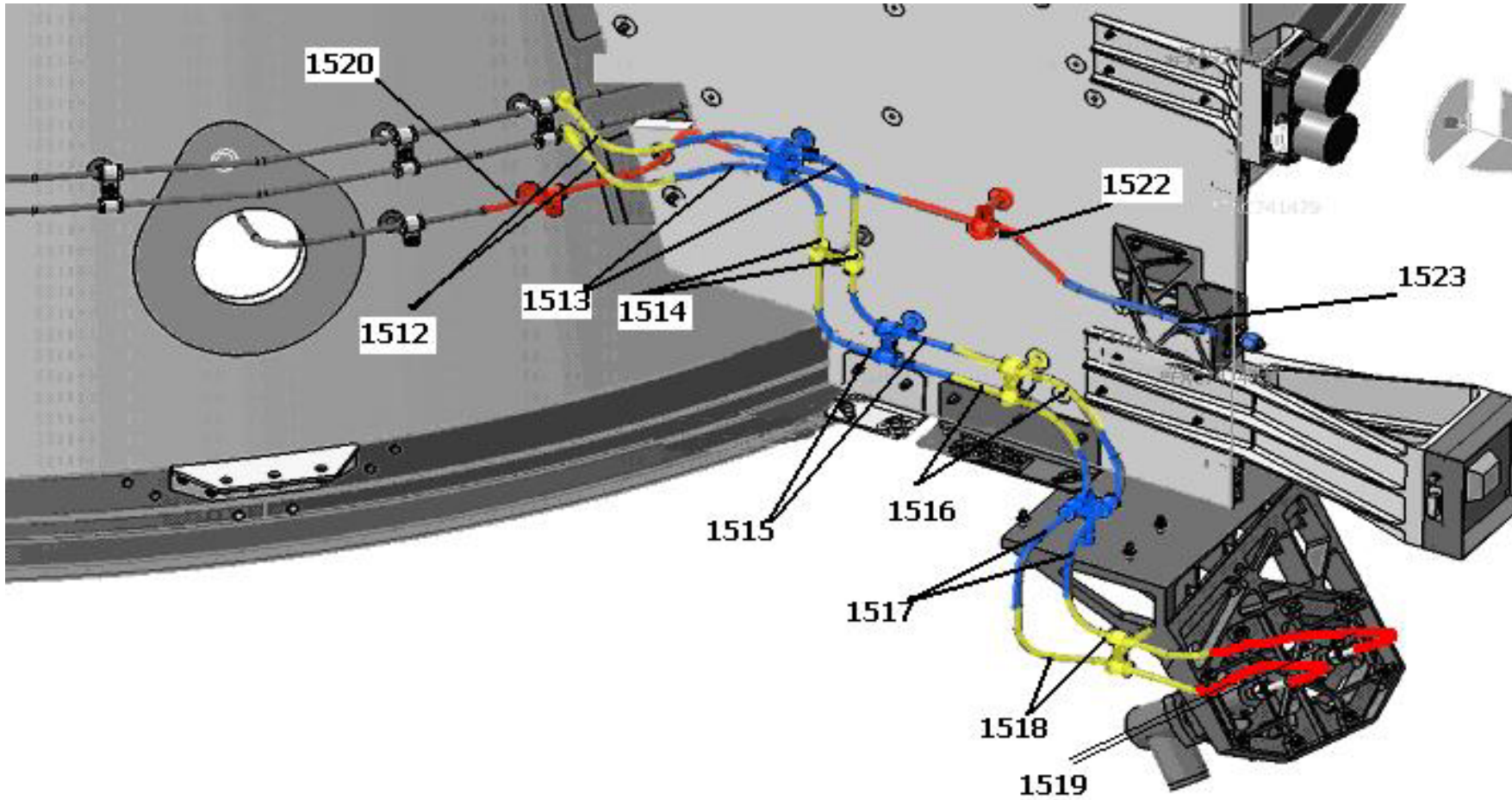

Figure 3.1.4-3 HERSCHEL – RCS line9

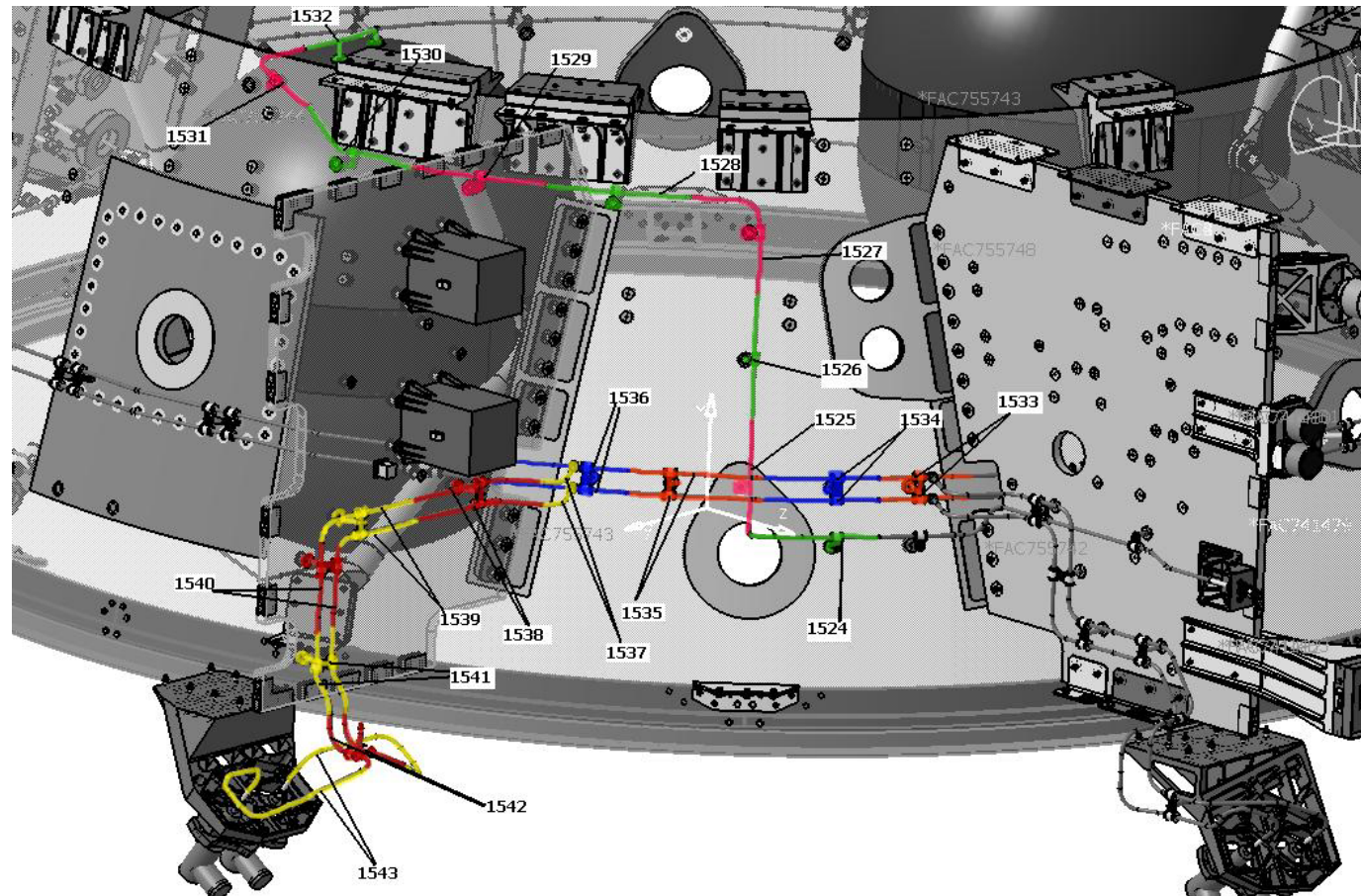

Figure 3.1.4-4 HERSHEL – RCS line11

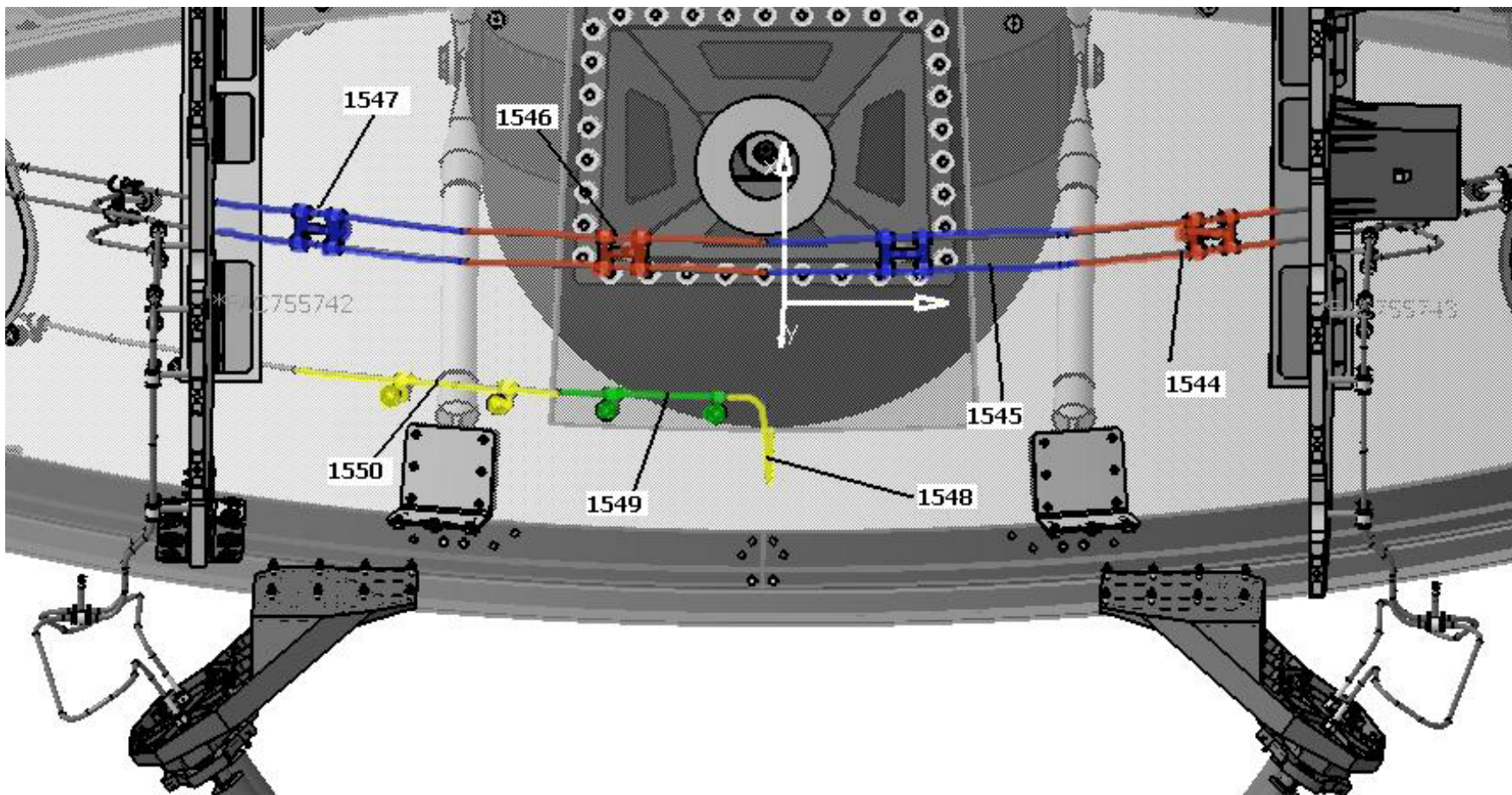

Figure 3.1.4-5 HERSCHEL – RCS line11

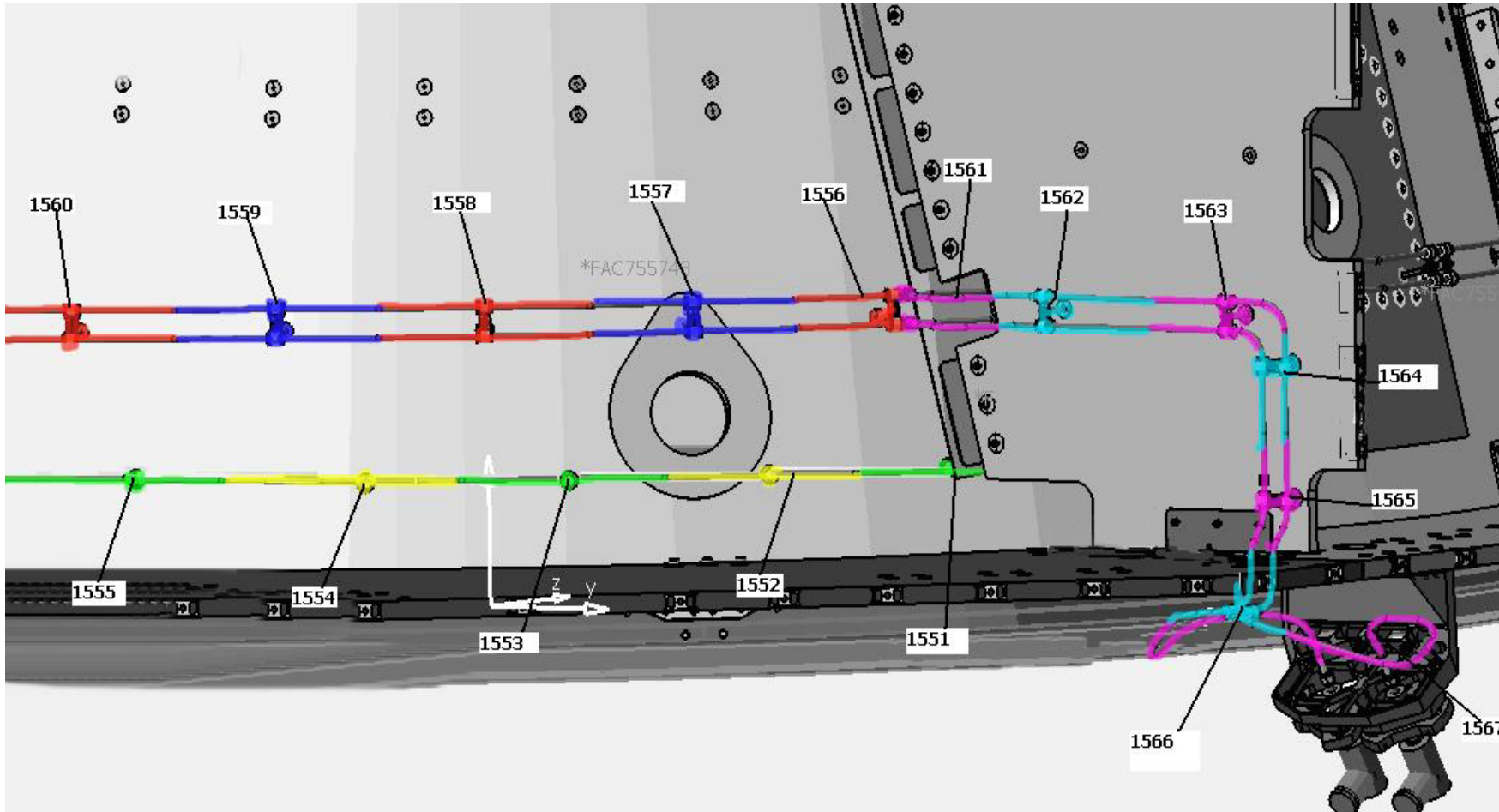

Figure 3.1.4-6 HERSHEL – RCS line35

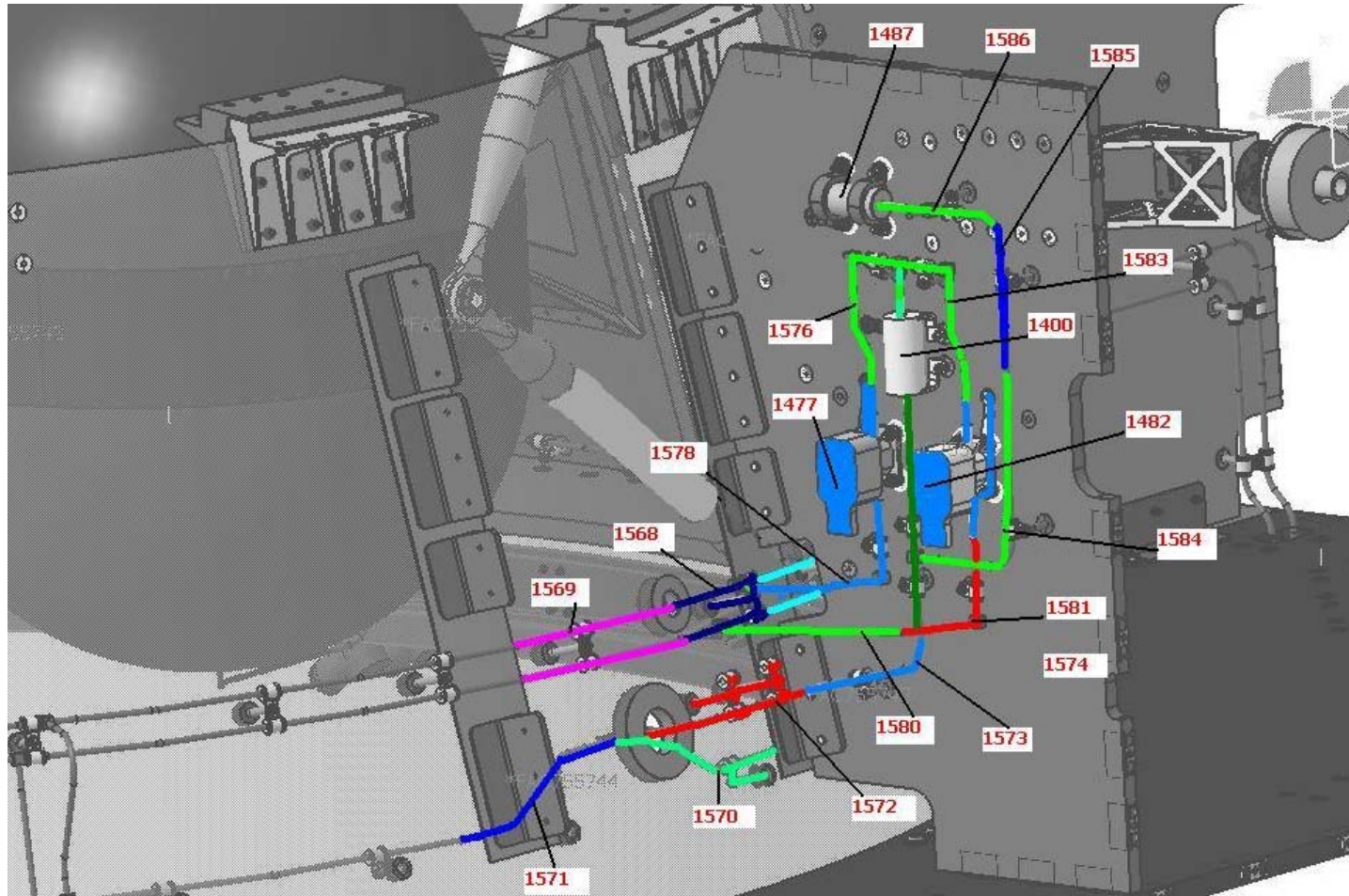

Figure 3.1.4-7 HERSHEL – RCS line37

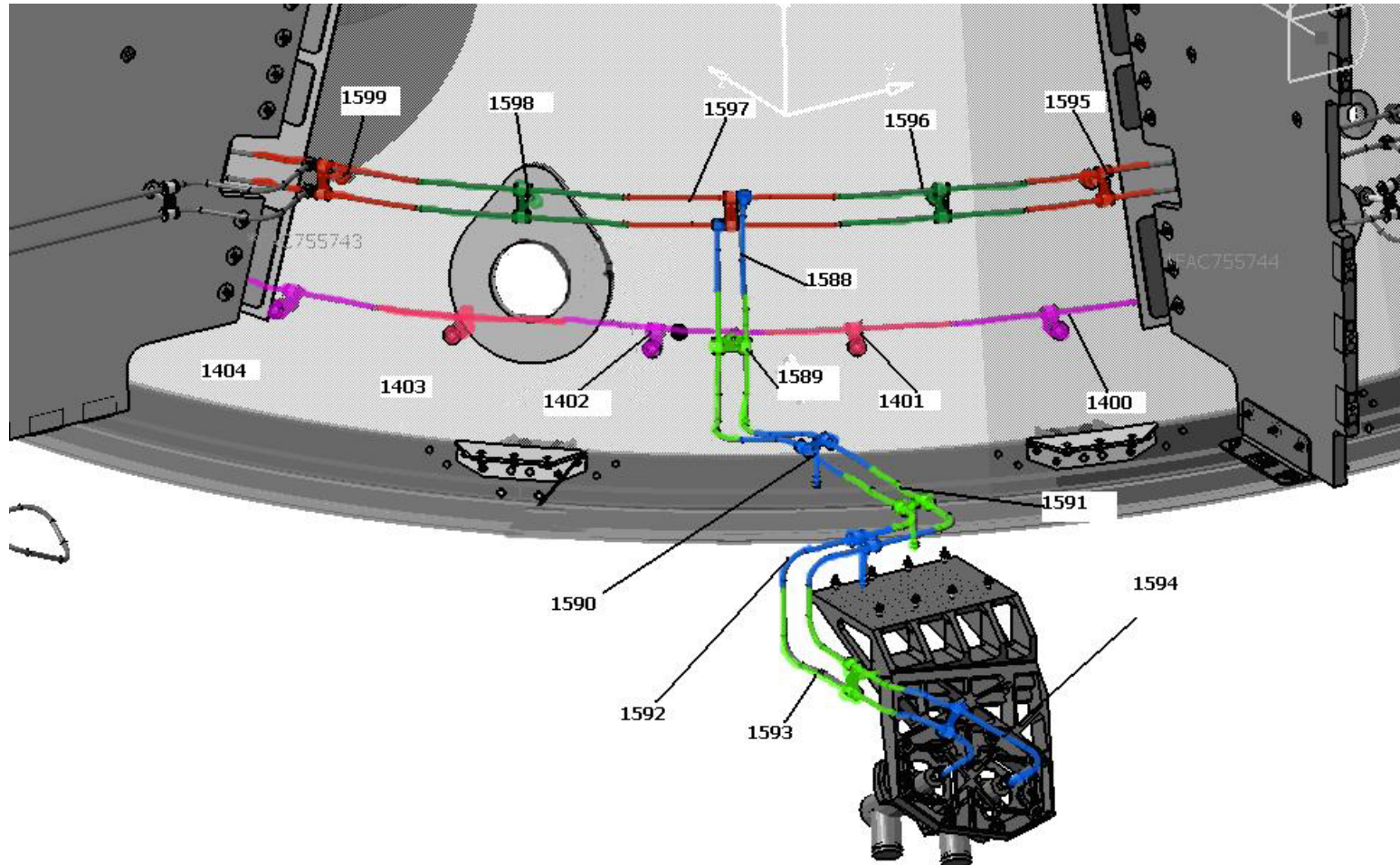

Figure 3.1.4-8 HERSCHEL – RCS line37-45

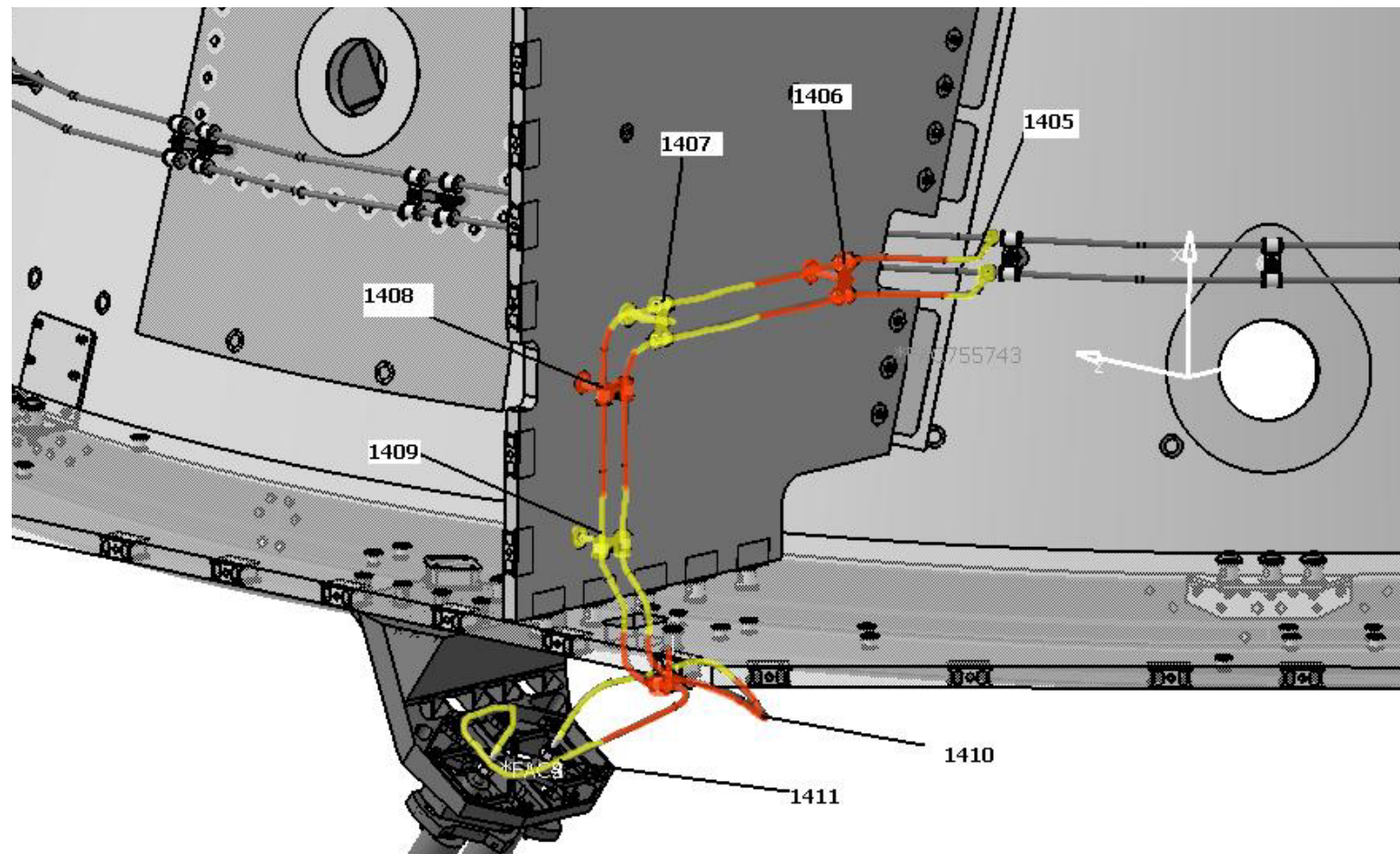

Figure 3.1.4-9 HERSCHEL – RCS line45

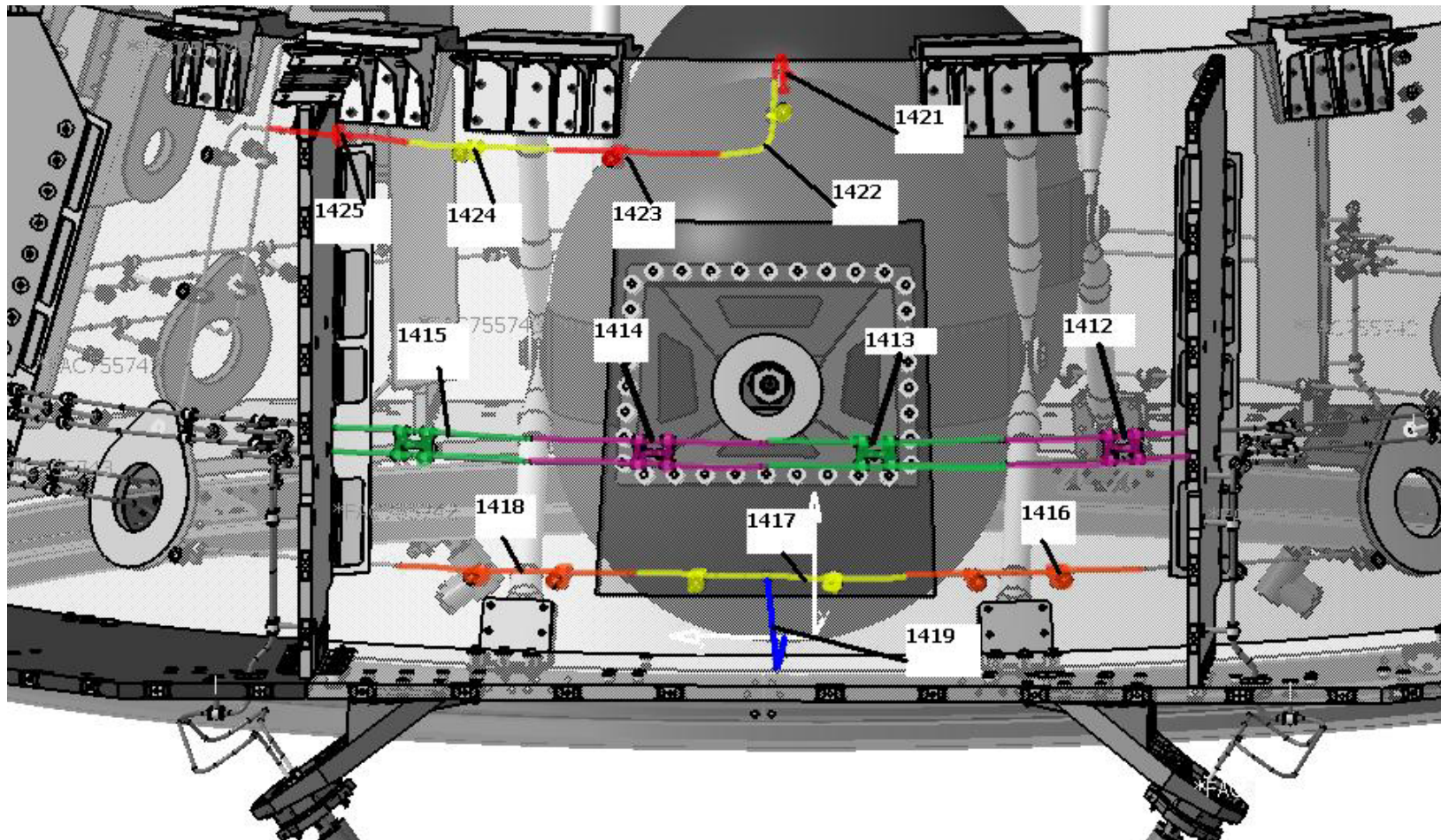

Figure 3.1.4-10 HERSHEL – RCS line46



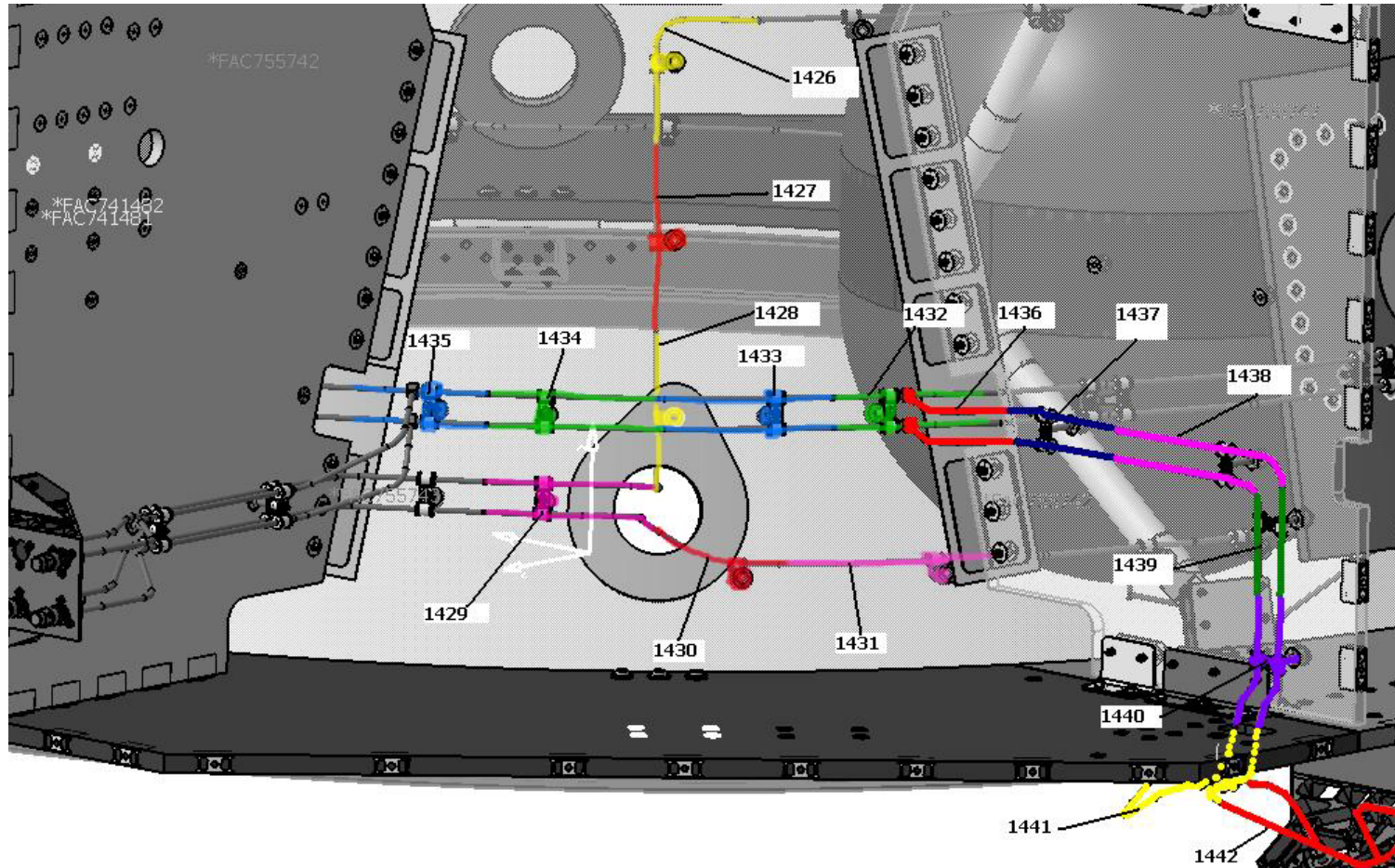

Figure 3.1.4-11 HERSHEL – RCS line47



NODE	LABEL	UNIT POWER DISSIPATION [W]								
		A	B	C	D	E	F	G	H	I
		EOL	EOL	EOL	EOL	EOL	EOL	BOL	BOL	BOL Survival
107	TWTA2	0	0	0	0	0	0	0	0	0
<b>PANEL +Y</b>										
201	PCDU (***)	(***)	(***)	(***)	(***)	(***)	(***)	(***)	(***)	(***)
202	CDMU	37.7	37.7	37.7	37.7	37.7	37.7	37.7	37.7	37.7
203	ACC	32.1	32.1	32.1	32.1	32.1	32.1	32.1	32.1	32.1
204	BATT	2.3	2.3	2.3	2.3	2.3	2.3	2.3	2.3	6
<b>PANEL +Y-Z</b>										
<b>PACS</b>										
301	FPSPU1_2	30.3	30.3	30.3	30.3	30.3	30.3	30.3	30.3	0
303	FPDPU	24	24	24	24	24	24	24	24	0
304	FPBOLC	<b>6.6</b>	<b>48.6</b>	<b>6.6</b>	<b>6.6</b>	<b>48.6</b>	<b>6.6</b>	<b>6.6</b>	<b>6.6</b>	0
305	FPMECDEC	<b>20.9</b>	<b>21.6</b>	<b>65</b>	<b>20.9</b>	<b>21.6</b>	<b>65</b>	<b>20.9</b>	<b>20.9</b>	0
<b>PANEL -Z</b>										
401	CCU	5.4	5.4	5.4	5.4	5.4	5.4	5.4	5.4	0
<b>SPIRE</b>										
404	HSDCU	37	37	37	37	37	37	37	37	0
405	HSDPU	15.3	15.3	15.3	15.3	15.3	15.3	15.3	15.3	0
406	HSFCU	42.9	42.9	42.9	42.9	42.9	42.9	42.9	42.9	0
<b>PANEL -Y-Z</b>										
<b>HIFI SHORT</b>										
521	FHWOV	1.5	1.5	1.5	1.5	1.5	1.5	1.5	1.5	0
522	FHHRV	66.3	66.3	66.3	66.3	66.3	66.3	66.3	66.3	0
523	FHICU	31.4	29	29	31.4	29	29	29	31.4	0
524	FHFUCU	13	13	13	13	13	13	13	13	0
526	FHWEV	25.7	25.7	25.7	25.7	25.7	25.7	25.7	25.7	0
507	FHIFV	0.3	0	0	0.3	0	0	0	0.3	0
<b>PANEL -Y</b>										
<b>HIFI LONG</b>										
621	FHWOH	1.5	1.5	1.5	1.5	1.5	1.5	1.5	1.5	0
622	FHWEH	25.7	25.7	25.7	25.7	25.7	25.7	25.7	25.7	0
623	FHHRH	66.3	66.3	66.3	66.3	66.3	66.3	66.3	66.3	0
624	FHLCU	43.4	37.6	37.6	43.4	37.6	37.6	37.6	43.4	0
625	FHLSU	40.4	35.8	35.8	40.4	35.8	35.8	35.8	40.4	0
606	FHIFH	0.3	0	0	0.3	0	0	0	0.3	0
<b>PANEL -Y+Z</b>										
701	RWL1	<b>16</b>	<b>16</b>	<b>16</b>	<b>16</b>	<b>16</b>	<b>16</b>	<b>5</b>	<b>5</b>	0
702	RWL2	<b>16</b>	<b>16</b>	<b>16</b>	<b>16</b>	<b>16</b>	<b>16</b>	<b>5</b>	<b>5</b>	0
703	RWL3	<b>16</b>	<b>16</b>	<b>16</b>	<b>16</b>	<b>16</b>	<b>16</b>	<b>5</b>	<b>5</b>	0
704	RWL4	<b>16</b>	<b>16</b>	<b>16</b>	<b>16</b>	<b>16</b>	<b>16</b>	<b>5</b>	<b>5</b>	0
<b>STR ASSEMBLY</b>										
80014-68	STR1	10.95	10.95	10.95	10.95	10.95	10.95	10.95	10.95	0
81014-68	STR2	0	0	0	0	0	0	0	0	0
<b>THRUSTERS</b>										

NODE	LABEL	UNIT POWER DISSIPATION [W]								
		A	B	C	D	E	F	G	H	I
		EOL	EOL	EOL	EOL	EOL	EOL	BOL	BOL	BOL Survival
8102	A1A	0.71	0.71	0.71	0.71	0.71	0.71	0.71	0.71	0.71
8122	A1B	0.71	0.71	0.71	0.71	0.71	0.71	0.71	0.71	0.71
8202	C2A	2.84	2.84	2.84	2.84	2.84	2.84	2.84	2.84	5.68
8222	C2B	2.84	2.84	2.84	2.84	2.84	2.84	2.84	2.84	2.84
8302	C1A	2.84	2.84	2.84	2.84	2.84	2.84	2.84	2.84	5.68
8322	C1B	2.84	2.84	2.84	2.84	2.84	2.84	2.84	2.84	2.84
8402	A2A	0.71	0.71	0.71	0.71	0.71	0.71	0.71	0.71	0.71
8422	A2B	0.71	0.71	0.71	0.71	0.71	0.71	0.71	0.71	0.71
8502	C4A	2.84	2.84	2.84	2.84	2.84	2.84	2.84	2.84	5.68
8522	C4B	2.84	2.84	2.84	2.84	2.84	2.84	2.84	2.84	2.84
8602	C3A	2.84	2.84	2.84	2.84	2.84	2.84	2.84	2.84	5.68
8622	C3B	2.84	2.84	2.84	2.84	2.84	2.84	2.84	2.84	2.84

(\*) TT&C power: in Telecom mode (21h) the first value, in Scientific mode (3h) the second one

(\*\*) GYRO power is depending from the temperature level of the baseplate see A.D.27

(\*\*\*) In Telecom Mode PCDU has a dissipation of 76.2W in BOL and 80.0W in EOL  
 In Scientific Mode PCDU has a dissipation of 72.8W in BOL and 76.5W in EOL  
 In Survival Mode PCDU has a dissipation of 63.2W in BOL and 66.5W in EOL

Table 3.1.5-2 HERSCHEL - Units Power Dissipations

### 3.1.5 HERSCHEL Units Conductors Variations

HERSCHEL Unit–Panel contact conductances (including spreading effect if applicable) are given in Table 3.1.7-1; in this table updated values are highlighted. Further details about calculation methods are given in Par 7.

UNIT	NODE	PANEL	CAPACITY [J/K]	CONTACT AREA [cm <sup>2</sup> ]	CONTACT TYPE	GL [W/K]	
						was	Is
VMC	4	EXTERNAL +Z	360	77	Metal-Metal	1.23	1.70
SAS+Z	5	EXTERNAL +Z	130	7.44	Metal-Metal	0.749 with bracket (AD14)	0.749 with bracket (AD14)
MGA+Z	16	EXTERNAL +Z	69.2		Washer	0.0682 (AD17)	0.0682 (AD17)
LGA+Z	21	EXTERNAL +Z	110		Washer	0.0667 (AD16)	0.0667 (AD16)
LGA-Z	41	EXTERNAL -Z	110		Washer	0.0667 (AD16)	0.0667 (AD16)
SAS-Z	45	EXTERNAL -Z	130	7.44	Metal-Metal	0.749 with bracket (AD14)	0.749 with bracket (AD14)
SREM	49	EXTERNAL -Z	2160	295	Metal-Metal	0.7 (integral data)	6.0
AAD	56	EXTERNAL +Z	76.2	5.2	Metal-Metal	0.524 with bracket	0.524 with bracket

UNIT	NODE	PANEL	CAPACITY [J/K]	CONTACT AREA [cm <sup>2</sup> ]	CONTACT TYPE	GL [W/K]	
						was (AD15)	Is (AD15)
<b>GYRO</b>	81	SHEAR +Z+Y	4800	202	Filler	8.5	2.125
RFDN	101	+ Y + Z	3920	317(*)	Filler	2	2
EPC1	102	+ Y + Z	1287	118.5	Filler	6.33	6.33
EPC2	103	+ Y + Z	1287	118.5	Filler	3.58	3.58
XPND1	104	+ Y + Z	3688	109.2	Filler	5.77	5.77
XPND2	105	+ Y + Z	3688	109.2	Filler	5.77	5.77
TWTA1	106	+ Y + Z	442	136	Filler on Doubler	6.09	6.09
TWTA2	107	+ Y + Z	442	136	Filler on Doubler	6.09	6.09
CRS1	110	SHEAR +Y+Z	1523	29.6(*)	Filler	1.16	1.16
CRS2	111	SHEAR +Y+Z	1523	29.6(*)	Filler	1.16	1.16
PCDU	201	+ Y	23490	1802	Filler	18.0	18.0
CDMU	202	+ Y	12000	551	Filler	8.38	8.38
ACC	203	+ Y	10640	513	Filler	8.25	8.25
<b>BATT</b>	204	+ Y	5520	19.6(*)	Filler	0.57	2.0
FPSPU1-2	301	+ Y - Z	7000	510	Filler	8.92	8.92
<b>FPDPU</b>	303	+ Y - Z	7177	664	Filler	8.92	26.76
FPBOLC	304	+ Y - Z	17500	1105	Filler	10.65	10.65
FPMECDEC	305	+ Y - Z	18400	1736	Filler	16.52	16.52
CCU	401	- Z	6790	720	Filler	8.43	8.43
HSDCU	404	- Z	18369	282	Filler	8.62	8.62
HSDPU	405	- Z	7177	644	Filler	8.9	8.9
HSFCU	406	- Z	17900	500	Filler	9.32	9.32
FHWOV	501	- Y - Z	5100	2.4(*)	Filler	0.213	0.213
<b>FHHRV</b>	502	- Y - Z	10950	1102	Filler on Doubler	10.93	21.86
FHICU	503	- Y - Z	7621	644	Filler	8.3	8.3
FHFUCU	504	- Y - Z	7300	763	Filler	9.55	9.55
FHWEV	506	- Y - Z	6600	38.5(*)	Filler on Doubler	6.84	6.84
FHIFV	507	- Y - Z	480	49	Filler	1.5	1.5
FHWOH	601	- Y	5100	2.4(*)	Filler	0.213	0.213
FHWEH	602	- Y	6600	38.5(*)	Filler on Doubler	6.84	6.84
<b>FHHRH</b>	603	- Y	10950	1102	Filler	10.92	21.84
FHLCU	604	- Y	12000	750	Filler	9.34	9.34
FHLSU	605	- Y	11200	970	Filler	9.52	9.52
<b>FHIFH</b>	606.0	- Y	480	49	Filler	1.86	1.20
<b>RW1</b>	701	- Y + Z	4400		Metal-Metal	0.13	1.05
<b>RW2</b>	702	- Y + Z	4400		Metal-Metal	0.13	1.11
<b>RW3</b>	703	- Y + Z	4400		Metal-Metal	0.11	1.05
<b>RW4</b>	704	- Y + Z	4400		Metal-Metal	0.11	1.11
THR1	8133	+Z	92.1		Filler	0.8	1.6
THR2	8233	+Y+Z	92.1		Filler	0.8	1.6

UNIT	NODE	PANEL	CAPACITY [J/K]	CONTACT AREA [cm <sup>2</sup> ]	CONTACT TYPE	GL [W/K]	
						was	Is
THR3	8333	+Y-Z	92.1		Filler	0.8	1.6
THR4	8433	-Z	92.1		Filler	0.8	1.6
THR5	8533	-Y-Z	92.1		Filler	0.8	1.6
THR6	8633	-Y+Z	92.1		Filler	0.8	1.6
STR1					Metal-Metal	1.13 / 1.65 (AD26)	0.3 / 0.5
STR2					Metal-Metal	1.13 / 1.65 (AD26)	0.3 / 0.5

(\*) On feet

Table 3.1.6-1 HERSCHEL - Units-Panels conductance

### 3.1.6 HERSCHEL SVM-Payload I/F points

The interface nodes are the same of the CDR configuration:

<b>I/F NODES</b>	<b>I/F TYPE</b>
2701÷2712	CVV I/F
2713÷2714	I/F SH1-2 SSH BRACKETS
2715÷2717	I/F SSH STRUTS
2718÷2725	I/F SVM SHIELD
2726÷2731	I/F SS1÷6 SVM SHIELD

Table 3.1.7-1 HERSCHEL – SVM-Payload I/F points

In the following figure the attachment points with the PLM are shown.

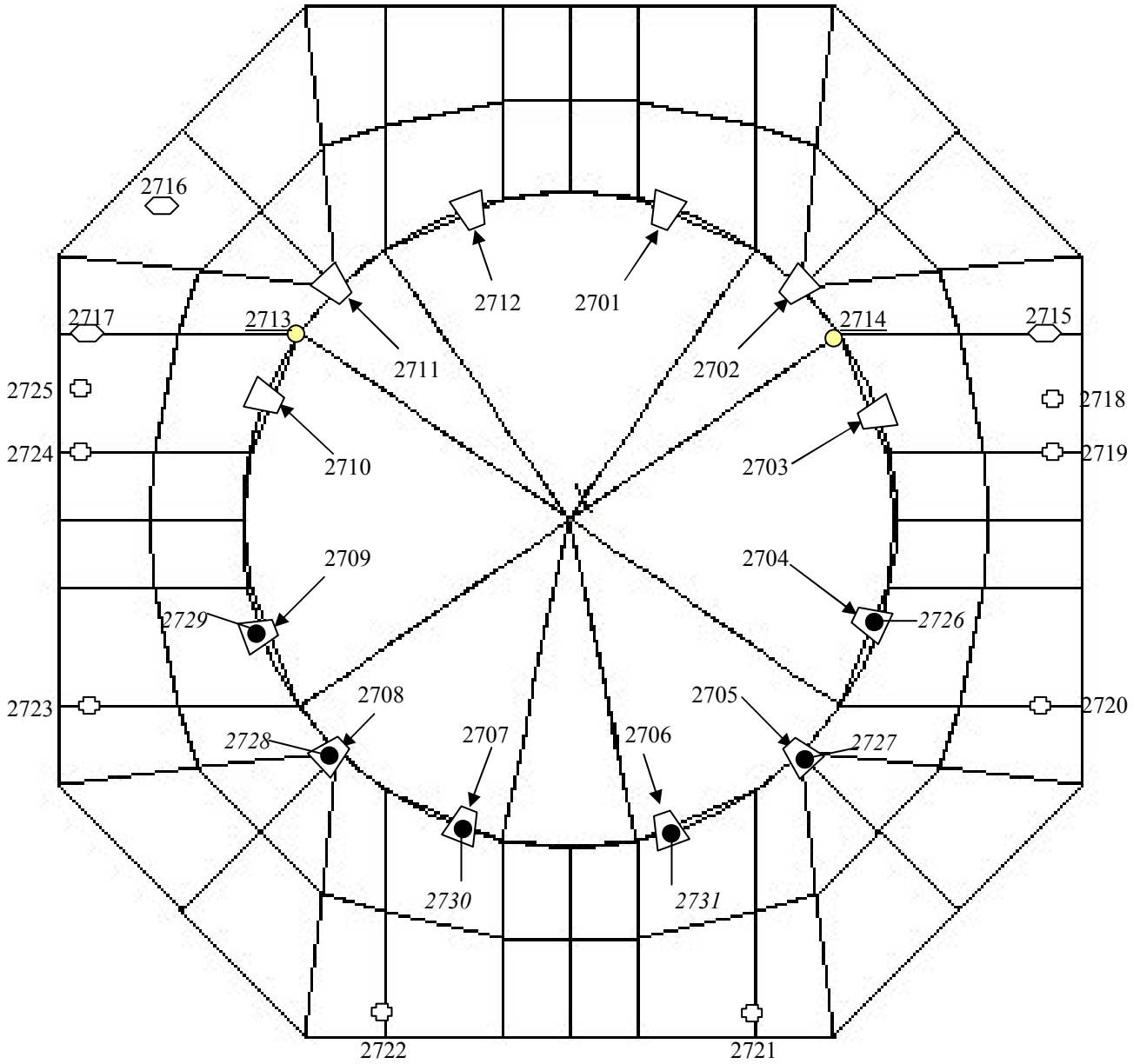

Figure 3.1.7-1 HERSCHEL – I/F points with PLM



#### **4 PLANCK MODELS DESCRIPTION**

The Geometric Mathematical Model (GMM) of PLANCK satellite has been built using Esarad (version 5.3.2) software and it is composed by two models, which describe respectively the internal enclosures of the spacecraft and the external environment of the spacecraft. A reduced model of the Payload Module, furnished by ALCATEL (AD19), have been introduced in the external GMM.

The Thermal Mathematical Model (TMM) of PLANCK has been prepared with Esatan software and contains the thermal node description, the thermal conductivity network and the unit and heater dissipation.

2516 nodes compose it:

1973 are Geometrical Nodes: 948 nodes are in the External GMM, 1025 nodes are in the Internal GMM, 6 nodes are in the External GMM coming from the Payload Module given by AD19. 537 are Mathematical Nodes

The termo-optical properties of the material used in the GMM/TMM are listed in Table 3.1.2.

The nodes of GMM/TMM with Number, Label, Area, Capacity, Material and thermal properties of each node at BOL / EOL conditions are provided in the AD25.

The only thermal property assumed to change during the satellite life is the solar absorptivity of the Solar array and of the Silver Teflon Tape.

The nodal breakdown of the GMM is reported in [AD25].

An overall view of PLANCK satellite is presented in the following figures.

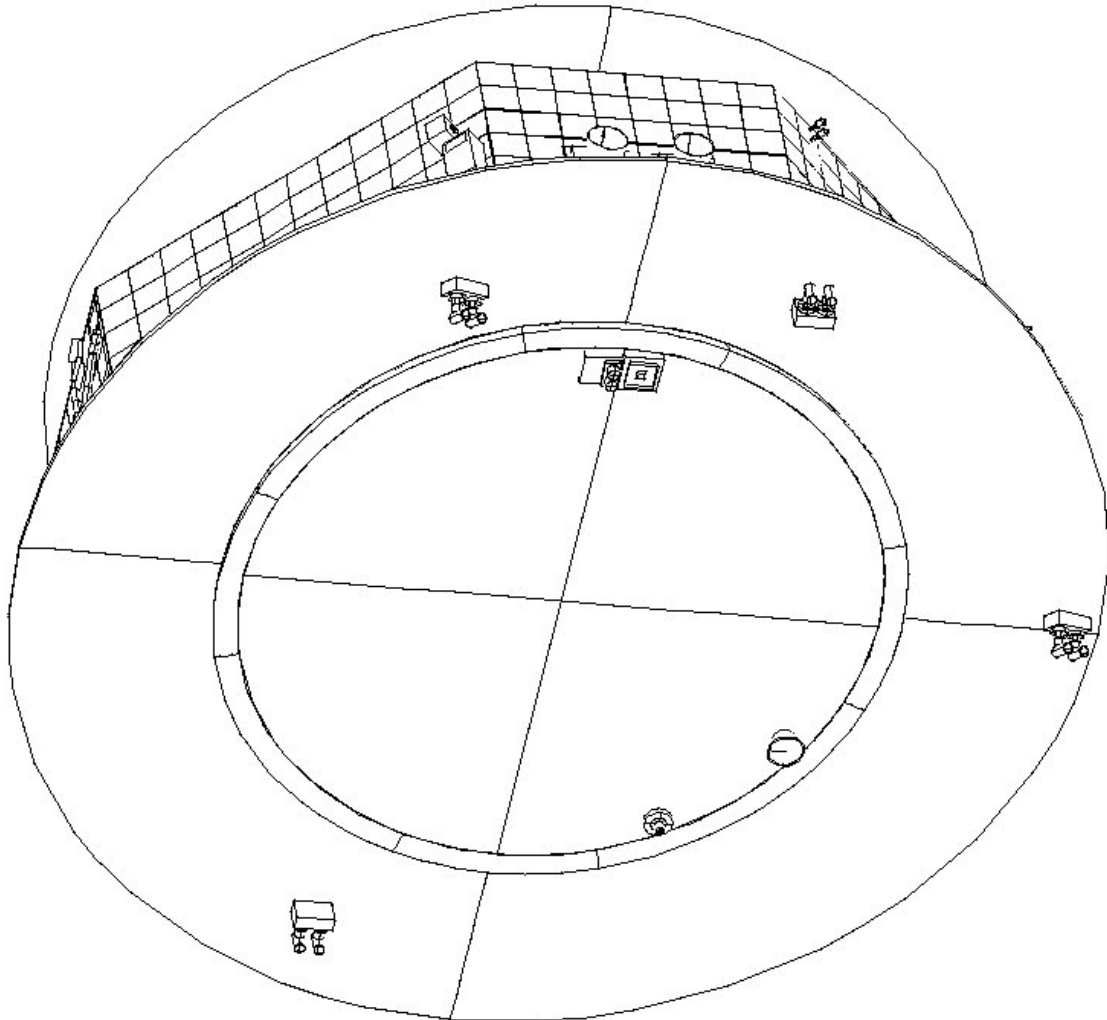

Figure 4-1 PLANCK - Overall view

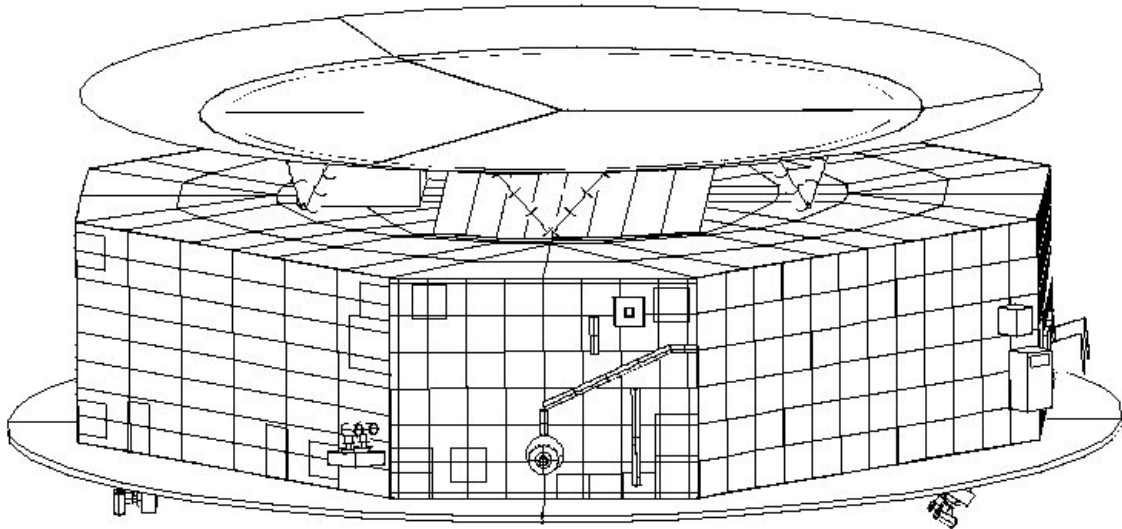

Figure 4-2 PLANCK - Overall view

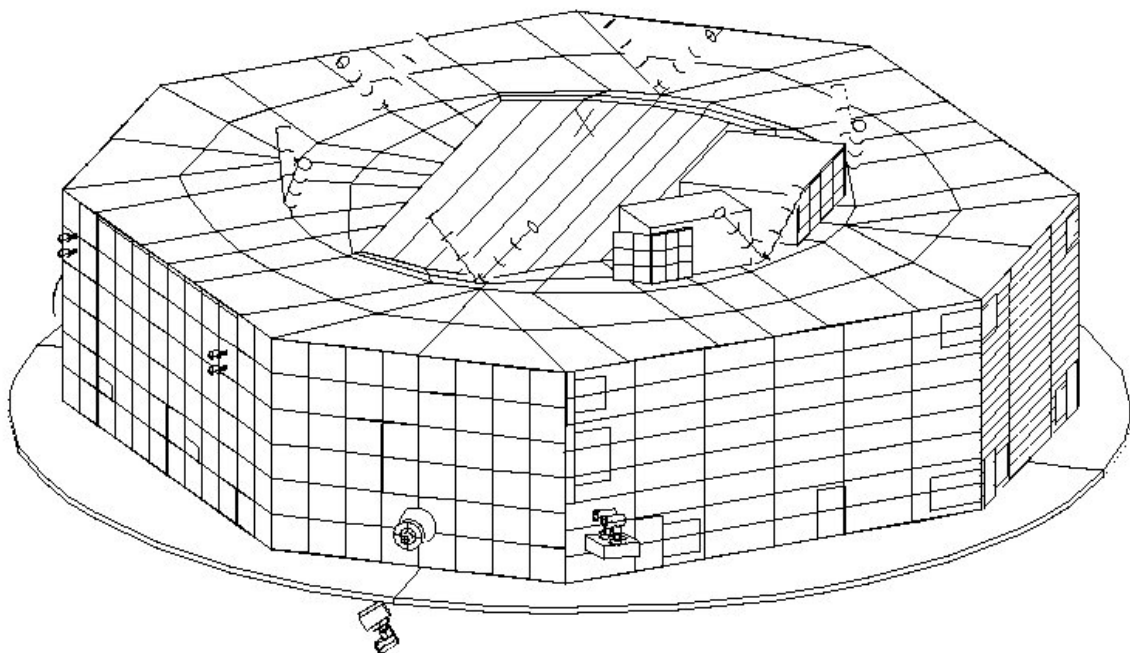

Figure 4-3 PLANCK - Overall view (Groove shield not plotted)

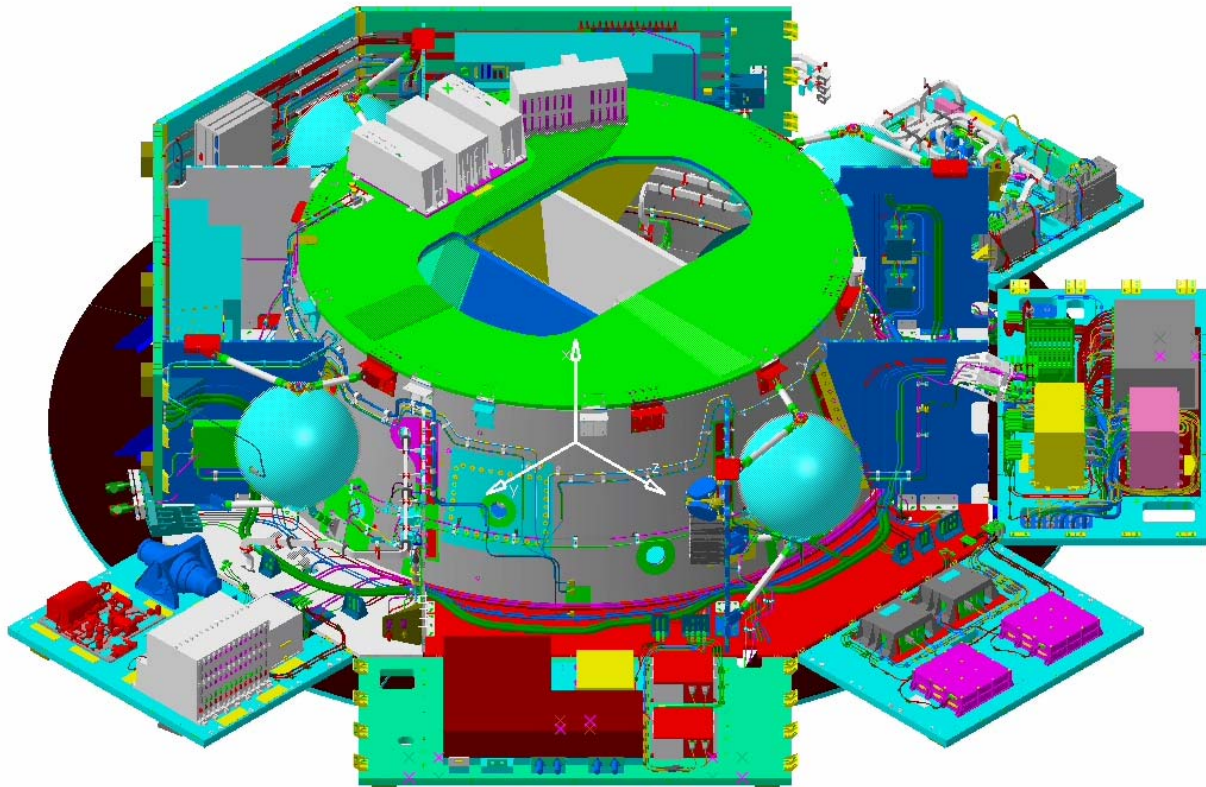

Figure 4-4 PLANCK – Internal overall View

#### 4.1 PLANCK GMM and TMM variation after SYSTEM CDR Data Package (July 2004)

A summary with a brief description of the variation applied on GMM and TMM models, since the last issue of the document, is here reported.

##### 4.1.1 PLANCK GMM Variations

- Modified the T-structure inside the Cone under the Subplatform (nodes 27xx).
- Removed external harness on panel +Y (ex-node 4926)
- The external side of the SAS -X housing (node 4950) have been modified to MLI blanket (alpha=0.92 epsilon=0.86) instead of Silver Teflon tape.
- Modified the radiative area on external panel +Y+Z due to the routing of the SREM harness. The following figure shows the radiative area considered on +Y+Z panel. The surface of radiative area has been maintained the same as in the previous configuration (0.406 m<sup>2</sup>)

(3161) 4161	(3162) 4162	(3163) 4163	(3164) 4164	(3165) 4165	(3166) 4166	(3167) 4167	(3168) 4168	(3169) 4169	(3170) 4170	(3171) 4171	(3172) 4172
(3149) 4149	(3150) 4150	(3151) 4151	(3152) 4152	(3153) 4153	(3154) 4154	3155	3156	3157	3158	3159	3160
(3137) 4137	(3138) 4138	(3139) 4139	(3140) 4140	(3141) 4141	(3142) 4142	3143	3144	3145	3146	3147	3148
(3125) 4125	(3126) 4126	(3127) 4127	(3128) 4128	(3129) 4129	(3130) 4130	(3131) 4131	3132	3133	3134	3135	3136
(3113) 4113	(3114) 4114	(3115) 4115	(3116) 4116	(3117) 4117	(3118) 4118	(3119) 4119	(3120) 4120	3121	3122	3123	3124
(3101) 4101	(3102) 4102	(3103) 4103	(3104) 4104	(3105) 4105	(3106) 4106	(3107) 4107	(3108) 4108	(3109) 4109	(3110) 4110	(3111) 4111	(3112) 4112

Figure 4.1.1-1 PLANCK Panel +Y+Z external radiative area

- Introduced external MLI blankets covering the Wave Guides on panels -Y, -Y-Z, +Y. The following sketches show the nodal breakdown of the added MLI blankets.

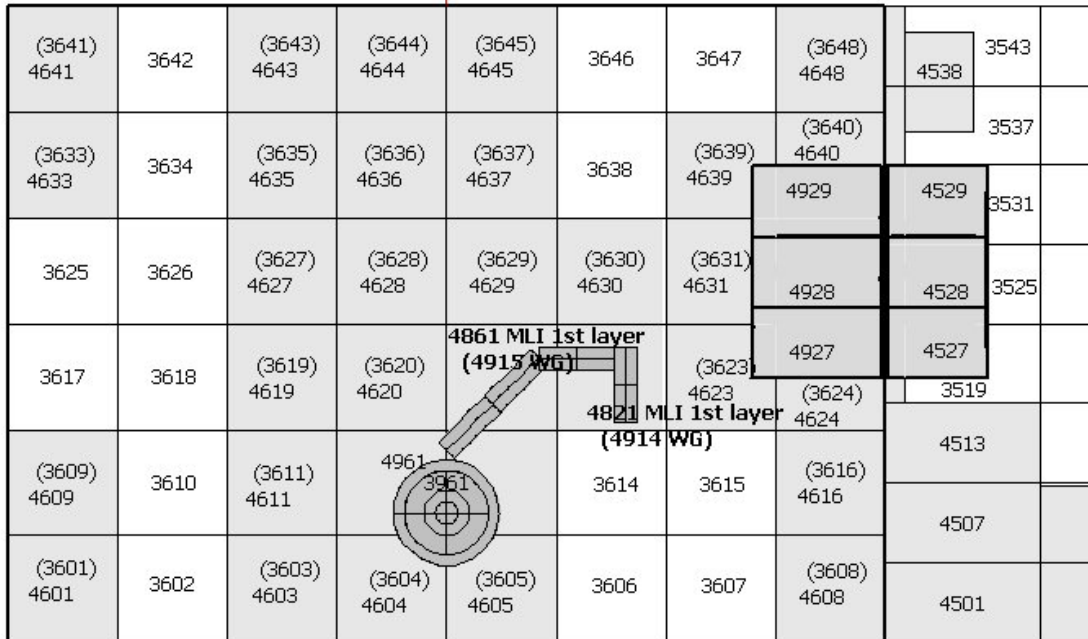

Figure 4.1.1-2 PLANCK - Wave Guides MLI blankets on panels -Y , -Y-Z

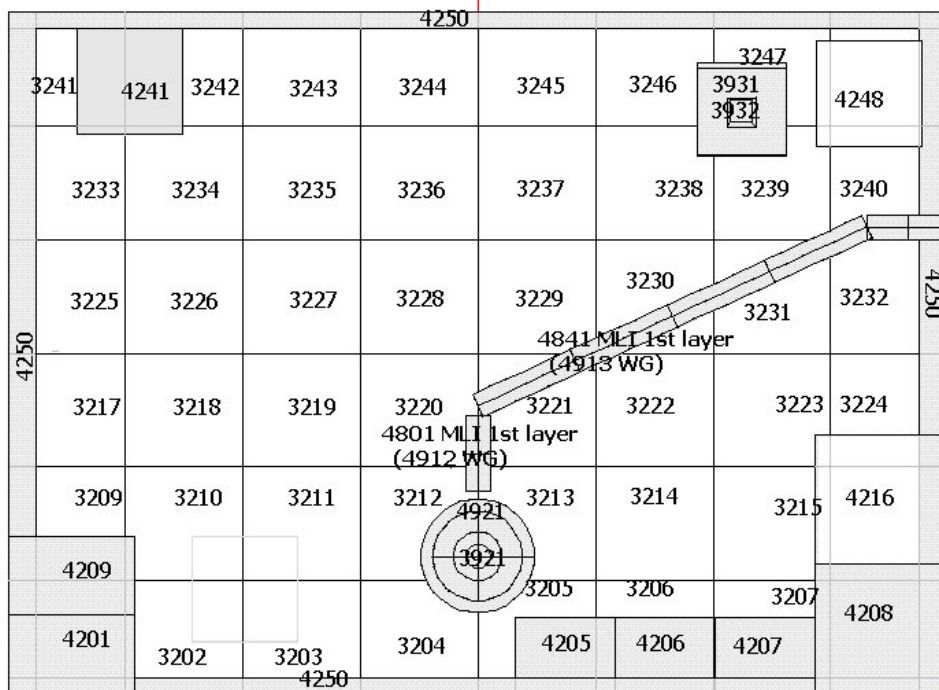

Figure 4.1.1-3 PLANCK - Wave Guides MLI blankets on panels +Y

- Introduction of 1mm doubler on +Y panel under 4K CCU and 4K CAU. See on next figure the nodal breakdown of doubler (Nodes 6251–6294). The doubler emissivity is 0.9

6248	6247	6246	6245	6244 <u>6294</u>	6243 <u>6293</u>	6242 <u>6292</u>	6241 <u>6291</u>
6240	REU 205		6237	<u>6286</u> 6236	<u>6285</u>	6284 4K CAU 202	<u>6283</u> 6233
6232			6229	<u>6278</u> 6228	<u>6277</u>	<u>6276</u>	<u>6275</u> 6225
6224	6223	6222	6221	<u>6270</u> 6220	<u>6269</u> 6219	<u>6268</u> 6218	<u>6267</u> 6217
6216	4K CEU 204		6213	<u>6262</u> 4K CCU 211-232	<u>6261</u>	<u>6260</u>	<u>6259</u> 6209
6208	6207	6206	6205	<u>6254</u> 6204	<u>6253</u> 6203	<u>6252</u> 6202	<u>6251</u> 6201

Figure 4.1.1-4 PLANCK - Thermal doubler under 4K CCU and 4K CAU on +Y panel

A sketch of the updated Flight Configuration of external SVM panels is shown in Figure 6.1.1-5 (the drawing is viewed from +X axis and the panels are viewed from internal side, with the radiative areas projected on the internal panels. Grey colour represents the MLI and white colour represents the radiative areas), while a summary of the areas used in the current radiator layout is given in Table 4.1.1-1:

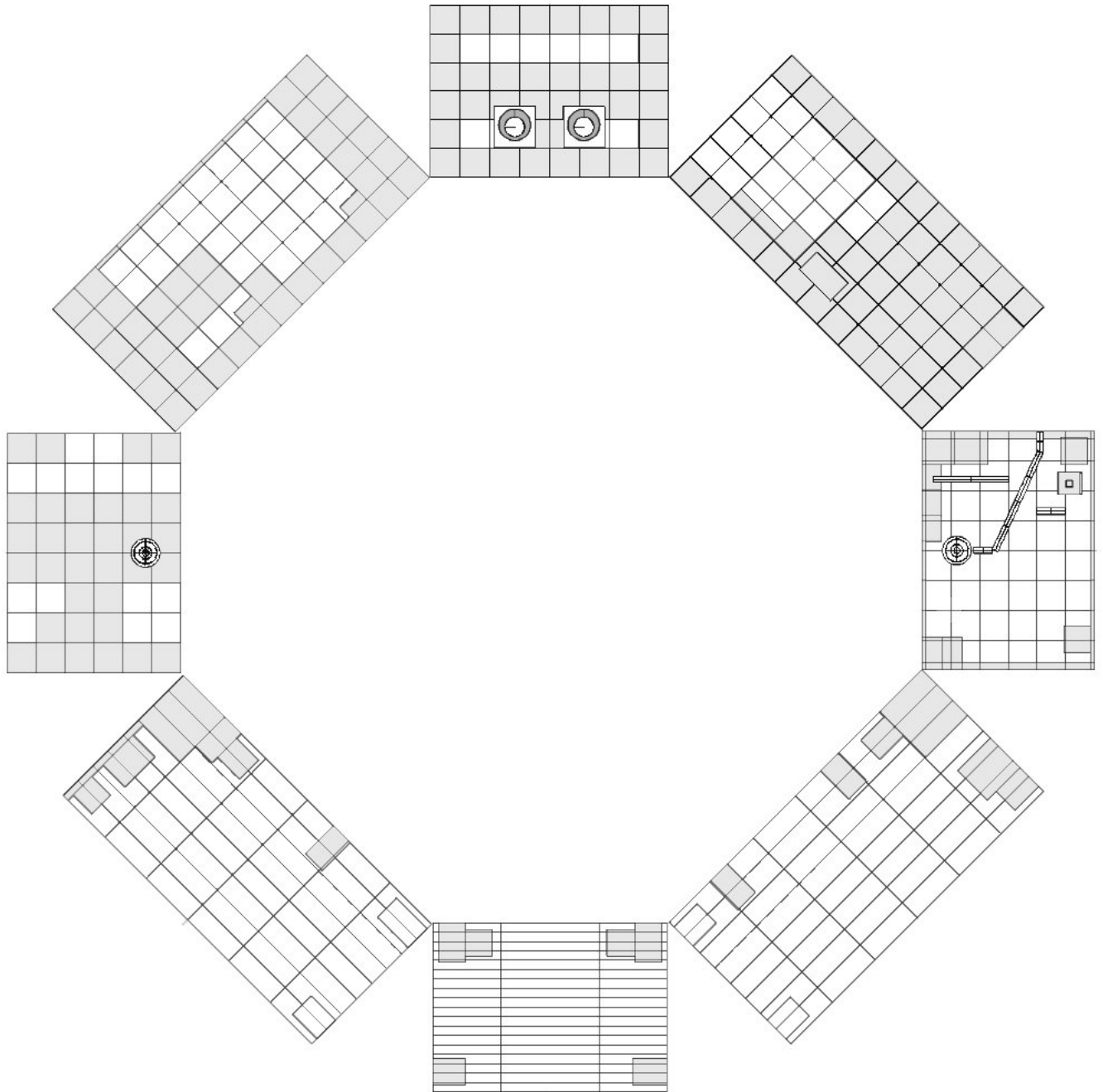

Figure 4.1.1-5 PLANCK - Radiative areas layout



Panel Location	Total Panel Area [m <sup>2</sup> ]	MLI Area [m <sup>2</sup> ]	Radiative Area [m <sup>2</sup> ]	Rad. Area / Total panel %
+Z	0.974	0.771	0.203	21%
+Y +Z	1.462	1.056	0.406	28%
+Y	0.974	0.275	0.699	72%
+Y -Z	1.462	0.269	1.193	82%
-Z	0.974	0.129	0.845	87%
-Y -Z	1.462	0.276	1.186	81%
-Y	0.974	0.67	0.304	31%
-Y +Z	1.462	0.831	0.632	43%
<b>Total Panels</b>	<b>9.744</b>	<b>4.277</b>	<b>5.468</b>	<b>56%</b>
BEU	-	-	0.1026	
PAU	-	-	0.0608	

Table 4.1.1-1 PLANCK – Radiative and MLI Areas

#### 4.1.2 PLANCK TMM Variations

All the analysis have been performed in Transient condition, and the minimum and maximum temperatures reached during the run have been considered in this analysis.

- Update of the RCS model according to AD28. It includes linear couplings between RCS and structure, heater power distribution, setting of the thermostat thresholds in order to control every part of the lines within the operative limits.
- Variation of heater distribution power for the following lines
  - ✓ Helium Tank
    - added a new line on +Y Tank of 0.77 W
    - added a new line on -Z Tank of 1.54 W
    - added a new line on +Z Tank of 0.77 W
- Variation of heater threshold for the following lines:
  - SCC Heat Pipes Nominal and Survival cases
    - Line 07 -13°/-12°C
    - Line 08 -14°/-13°C
    - Line 09 -15°/-14°C
    - Line 10 -16°/-15°C
    - Line 11 -17°/-16°C
    - Line 12 -18°/-17°C
    - Line 13 -19°/-18°C

Propellant Tank in Survival Case 14°/17°C

FCV Thruster 14°/17°C

- Introduced cold Case analysis P2 (verifying stability requirements) with SCC2 operative.
  - Update linear conductors of T-structure inside the Cone.
  - Introduced Wave Guides models.
  - Introduced 1mm doubler on +Y panel under 4K CCU and 4K CAU. TMM updated accordingly
  - FOG power dissipation changed from 20W to:
    - BOL dissipation (3 channels) 16.5W
    - EOL dissipation (4 channels) 26.8W
- The design temperatures of the unit have been modified to 0° / +45°C (was 0°/+40°C) and in Non operative condition to -40°/+75°C.

SURFACES	MATERIALS	$\alpha$ BOL	$\alpha$ EOL	$\varepsilon$	Reference
<b>GMM INTERNAL</b>					
Internal panels, floors, cone, web	Black Paint Z306			0.87	ALS
He Tank -Y				0.86	
He Tank +Z,-Y,-Z	Aluminized tape			0.05	
MLI on Cone / Shear 5 and 8 of SCC enclosure , S/A disc int.side, Propellant Tank				0.05	ALS
Top and bottom floor of SCC enclosure				0.1	ALS assumption
SCC panels (HP and Aluminium skin)				0.18	ALS assumption
4K PREREG, 4K CCU, BEU, CDMU, ACC	Black paint			0.9	
EPC				0.88	
DPU, DCCU, REBA, FOG, 4K CAU, CEU, REU, DAE POWER, CRS, TWTA, BATTERY, PCDU, SCE	Black Paint Z306			0.87	ALS
XPND,RFDN				0.85	
Doubler under 4KCCU – 4KCAU				0.9	
BEU enclosure MLI (int.side)				0.76	
1N Thruster				0.4	
<b>GMM EXTERNAL</b>					
AAD top surface		0.96	=	0.83	HP-4-TNO-RP-A004
AAD chip		0.9	=	0.013	HP-4-TNO-RP-A004
External panels	Black Paint Z307	0.96	=	0.87	ALS
MLI to PPLM/ MLI BEU and PAU	VDA Kapton (Al side)	0.15	=	0.05	
MLI	Carbon Filled Kapton	0.92	=	0.86	
BEU/PAU radiators	Black Paint	0.9	=	0.9	
Thrusters nozzle		0.5	=	0.12	Integral data
Thrusters heat barrier / head plate		0.5	=	0.3	Integral data
Thrusters bracket		0.15	=	0.05	Integral data
Thrusters FCV				0.7	Integral data
Launcher adaptor ring	Chromic acid	0.5	=	0.5	
Launcher adaptor edge	Silver teflon / alodine	0.157	0.241	0.601	Average $\alpha / \varepsilon$ values
SAS housing/pyramid		0.96	=	0.83	HP-4-TNO-RP-S004
SAS chip		0.9	=	0.82	HP-4-TNO-RP-S004
SAS –X housing external edge	Carbon Filled Kapton	0.92	=	0.86	
SREM		0.52	=	0.12	Integral data
Solar Array ext disc		0.8	=	0.84	
Solar Array central disc		0.86	0.83	0.84	
PLM Groove shield		0.15	=	0.05	HP-1-ASP-TN-0417
PLM struts		0.85	=	0.85	HP-1-ASP-TN-0417
MGA / LGA	Alodine 1200 S	0.46	=	0.1	HP-AN-RY-0020/21
LGA	White paint	0.6	=	0.88	HP-AN-RY-0020
MGA	Germanium	0.6	=	0.72	HP-AN-RY-0021

Table 4.1.2-1 PLANCK – SVM Thermal-optical Properties

#### 4.1.3 PLANCK SVM-Payload I/F points

The interface nodes are:

<b>I/F NODES</b>	<b>I/F TYPE</b>
10001-10004-10005	Groove Shield
10010-10011-10012	Mechanical struts
10021 ÷ 10026	PLM I/F nodes

Table 4.1.3-1 PLANCK – SVM-Payload I/F points

In the following figure the attachment points with the PLM are shown.

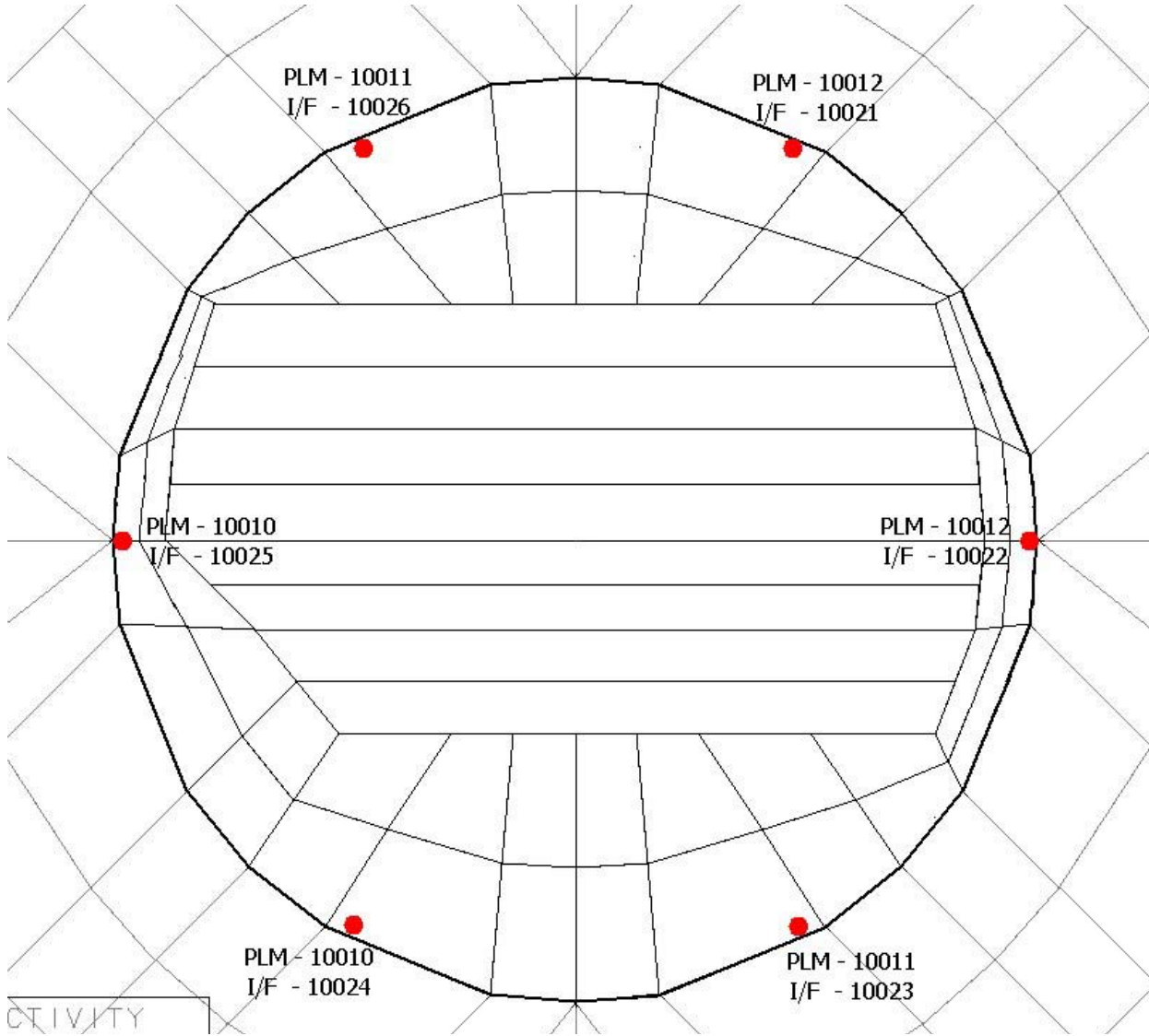

Figure 4.1.3-1 PLANCK - PLM I/F attachment points

4.1.4 Solar Array Thermo optical properties

In the Figure 4.1.5-1 the thermo optical properties of the Loaded and Unloaded cells of Solar Array (External Ring and Central Disc) are displayed. Concerning the Central Disc, in the Geometrical Model the average of the thermo-optical properties are considered.

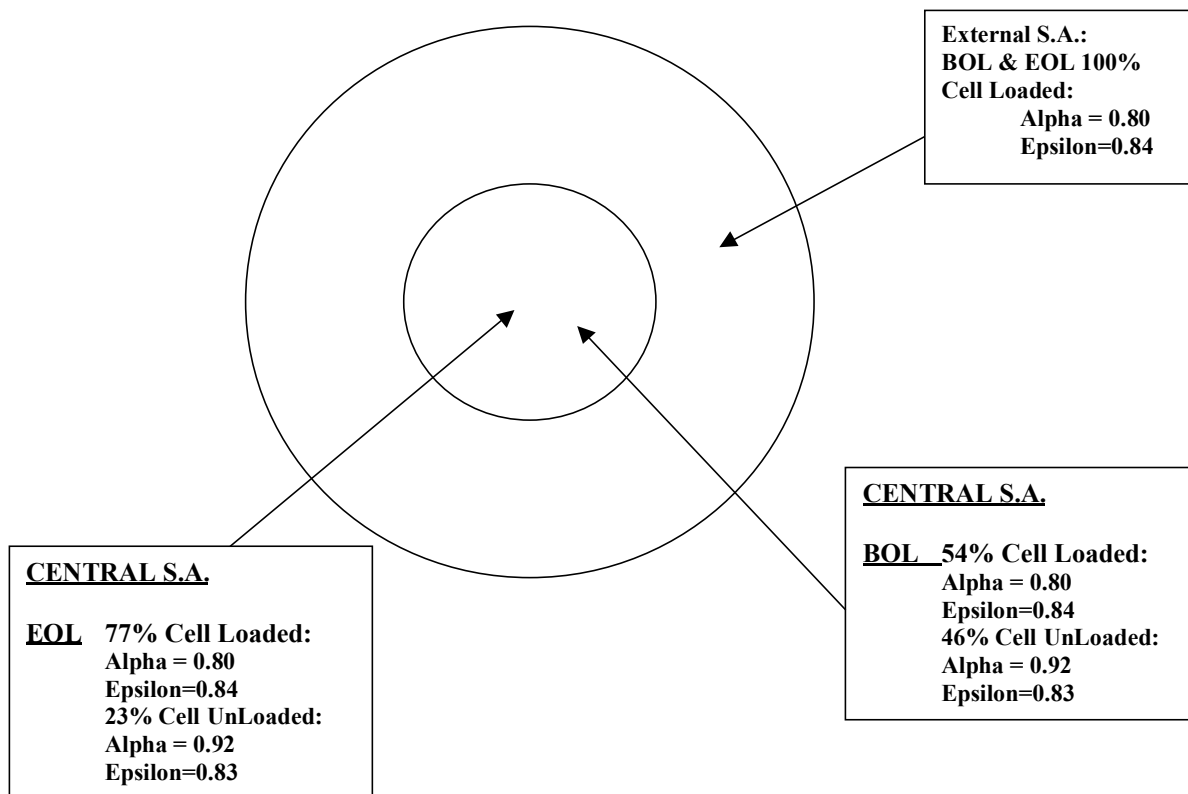

Figure 4.1.5-1 PLANCK – Solar Array thermal-optical properties

#### 4.1.5 PLANCK Power dissipations

The dissipation modes are identified in the following table respect to the status of the HFI and LFI system:

MODE	HFI	LFI
1	Prime	Prime
2	Prime	Standby
3	Standby	Prime

Table 4.1.6-1 PLANCK – Payload Units operating modes

The complete list of the power dissipation in Scientific and Telecom Mode for each case are reported in Table 4.1.6-2.

Sub-System	Switchable Unit	POWER DISSIPATION [W]					
		A1	A2	A3	B1	B2	C
		Scientific Mode	Scientific Mode	Scientific Mode	Scientific Mode	Scientific Mode	Survival
CDMS	CDMU	37.7 W	37.7 W	37.7 W	37.7 W	37.7 W	37.7 W
ACMS	AAD	0.0 W	0.0 W	0.0 W	0.0 W	0.0 W	0.0 W
	ACC	32.1 W	32.1 W	32.1 W	32.1 W	32.1 W	32.1 W
	STR1	10.95 W	10.95 W	10.95 W	10.95 W	10.95 W	OFF
	STR2	0.0 W	0.0 W	0.0 W	0.0 W	0.0 W	0.0 W
	SAS	0.0 W	0.0 W	0.0 W	0.0 W	0.0 W	0.0 W
	SAS	0.0 W	0.0 W	0.0 W	0.0 W	0.0 W	0.0 W
	CRS1	8.3 W	8.3 W	8.3 W	8.3 W	8.3 W	8.3 W
	CRS2	8.3 W	8.3 W	8.3 W	8.3 W	8.3 W	8.3 W
	CRS3	8.3 W	8.3 W	8.3 W	8.3 W	8.3 W	8.3 W
TTC		duration = 21 hr	duration = 21 hr	duration = 21 hr	duration = 21 hr	duration = 21 hr	
	XPND1	Rx 21 W	Rx 21 W	Rx 21 W	Rx 21 W	Rx 21 W	Rx+Tx 23 W
	XPND2	Rx 10 W	Rx 10 W	Rx 10 W	Rx 10 W	Rx 10 W	Rx 10 W
	EPC1	9.0 W	9.0 W	9.0 W	9.0 W	9.0 W	9.0 W
	EPC2	0.0 W	0.0 W	0.0 W	0.0 W	0.0 W	0.0 W
	TWT1	0.0 W	0.0 W	0.0 W	0.0 W	0.0 W	37 W
	TWT2	0.0 W	0.0 W	0.0 W	0.0 W	0.0 W	0.0 W
	RFDN	0.0 W	0.0 W	0.0 W	0.0 W	0.0 W	11.8 W
	LGA1	Rx2 0.0 W	Rx2 0.0 W	Rx2 0.0 W	Rx2 0.0 W	Rx2 0.0 W	Rx1+Tx2 0.0 W
	LGA2	0.0 W	0.0 W	0.0 W	0.0 W	0.0 W	Rx2+Tx1 3.0 W
	LGA3	0.0 W	0.0 W	0.0 W	0.0 W	0.0 W	Rx2+Tx1 3.0 W
MGA	Rx1 0.0 W	Rx1 0.0 W	Rx1 0.0 W	Rx1 0.0 W	Rx1 0.0 W	OFF	
Power	PCDU	BOL 98.6 W / EOL 102.9 W	BOL 98.6 W / EOL 102.9 W	BOL 98.6 W / EOL 102.9 W	BOL 98.6 W / EOL 102.9 W	BOL 98.6 W / EOL 102.9 W	BOL 81.2 W / EOL 84.1 W
	Battery	2.3 W	2.3 W	2.3 W	2.3 W	2.3 W	6.0 W
u s t							

Sub-System	Switchable Unit	POWER DISSIPATION [W]					
		A1	A2	A3	B1	B2	C
		Scientific Mode	Scientific Mode	Scientific Mode	Scientific Mode	Scientific Mode	Survival
	THR D1A	0.71	0.71	0.71	0.71	0.71	3.55
	THR D1B	0.71	0.71	0.71	0.71	0.71	0.71
	THR D2A	0.71	0.71	0.71	0.71	0.71	3.55
	THR D2B	0.71	0.71	0.71	0.71	0.71	0.71
	THR F1A	0.71	0.71	0.71	0.71	0.71	3.55
	THR F1B	0.71	0.71	0.71	0.71	0.71	0.71
	THR F2A	0.71	0.71	0.71	0.71	0.71	3.55
	THR F2B	0.71	0.71	0.71	0.71	0.71	0.71
	THR U1A	2.84	2.84	2.84	2.84	2.84	5.68
	THR U1B	2.84	2.84	2.84	2.84	2.84	2.84
	THR U2A	2.84	2.84	2.84	2.84	2.84	5.68
	THR U2B	2.84	2.84	2.84	2.84	2.84	2.84
	THR A1A	4.56	4.56	4.56	4.56	4.56	0.0
	THR A1B	0.0	0.0	0.0	0.0	0.0	0.0
	THR B1A	4.56	4.56	4.56	4.56	4.56	0.0
	THR B1B	0.0	0.0	0.0	0.0	0.0	0.0
ESA Items							
	SREM	2.6 W	2.6 W	2.6 W	2.6 W	2.6 W	OFF
	FOG	16.5 W	16.5 W	16.5 W	26.8 W	26.8 W	OFF
HFI		duration = 21 hr	duration = 21 hr	duration = 21 hr	duration = 21 hr	duration = 21 hr	
	DPU N	22 W	22 W	22 W	22 W	22 W	OFF
	DPU R	0.0 W	0.0 W	0.0 W	0.0 W	0.0 W	0.0 W
	PAU	15 W	15 W	OFF	15 W	15 W	0.0 W
	REU	92 W	92 W	92 W	92 W	92 W	0.0 W
	4K CAU	15 W	15 W	15 W	15 W	15 W	0.0 W
	4K CEU (4KCDE)	42.8 W	42.8 W	42.8 W	42.8 W	42.8 W	0.0 W
	4K PRU (4KCCR)	21 W	21 W	OFF	21 W	21 W	0.0 W
	4K CCU	60 W	60 W	60 W	60 W	60 W	0.0 W
0.1 K DCCU	16 W	16 W	16 W	16 W	16 W	0.0 W	
LFI		duration = 21 hr	duration = 21 hr	duration = 21 hr	duration = 21 hr	Duration = 21 hr	
	BEU Right -Y	8.77 W	OFF	8.77 W	8.77 W	8.77 W	0.0 W
	BEU Central	12 W	OFF	12 W	12 W	12 W	0.0 W
	BEU Left +Y	11 W	OFF	11 W	11 W	11 W	0.0 W
	DAE	13 W	OFF	13 W	13 W	13 W	0.0 W
	REBA N	41.5 W	41.5 W	41.5 W	41.5 W	41.5 W	0.0 W
	REBA R	0.0 W	0.0 W	0.0 W	0.0 W	0.0 W	0.0 W
SCS		duration = 21 hr	Duration = 21 hr	duration = 21 hr	duration = 21 hr	Duration = 21 hr	
	SCC N	See Array values	See Array values	See Array values	See Array values	0.0 W	0.0 W
	SCC R	0.0 W	0.0 W	0.0 W	0.0 W	See Array values	0.0 W
	SCE N	110 W	110 W	110 W	110 W	0.0 W	0.0 W
SCE R	0.0 W	0.0 W	0.0 W	0.0 W	110 W	0.0 W	



Table 4.1.6-2 PLANCK – Scientific Mode Power dissipations

Sub-System	Switchable Unit	POWER DISSIPATION [W]				
		A1	A2	A3	B1	B2
		Telecom	Telecom	Telecom	Telecom	Telecom
CDMS						
	CDMU	37.7 W	37.7 W	37.7 W	37.7 W	37.7 W
ACMS	AAD	0.0 W	0.0 W	0.0 W	0.0 W	0.0 W
	ACC	32.1 W	32.1 W	32.1 W	32.1 W	32.1 W
	STR1	10.95 W	10.95 W	10.95 W	10.95 W	10.95 W
	STR2	0.0 W	0.0 W	0.0 W	0.0 W	0.0 W
	SAS	0.0 W	0.0 W	0.0 W	0.0 W	0.0 W
	SAS	0.0 W	0.0 W	0.0 W	0.0 W	0.0 W
	CRS1	8.3 W	8.3 W	8.3 W	8.3 W	8.3 W
	CRS2	8.3 W	8.3 W	8.3 W	8.3 W	8.3 W
	CRS3	8.3 W	8.3 W	8.3 W	8.3 W	8.3 W
TTC		<b>duration = 3 hr</b>	<b>duration = 3 hr</b>	<b>duration = 3 hr</b>	<b>duration = 3 hr</b>	<b>duration = 3 hr</b>
	XPND1	Rx+Tx 23 W	Rx+Tx 23 W	Rx+Tx 23 W	Rx+Tx 23 W	Rx+Tx 23 W
	XPND2	Rx 10 W	Rx 10 W	Rx 10 W	Rx 10 W	Rx 10 W
	EPC1	9.0 W	9.0 W	9.0 W	9.0 W	9.0 W
	EPC2	0.0 W	0.0 W	0.0 W	0.0 W	0.0 W
	TWT1	37 W	37 W	37 W	37 W	37 W
	TWT2	0.0 W	0.0 W	0.0 W	0.0 W	0.0 W
	RFDN	11.8 W	11.8 W	11.8 W	11.8 W	11.8 W
	LGA1	0.0 W	0.0 W	0.0 W	0.0 W	0.0 W
	LGA2	Rx2+Tx2 0.0 W	Rx2+Tx2 0.0 W	Rx2+Tx2 0.0 W	Rx2+Tx2 0.0 W	Rx2+Tx2 0.0 W
	LGA3	Rx2+Tx2 0.0 W	Rx2+Tx2 0.0 W	Rx2+Tx2 0.0 W	Rx2+Tx2 0.0 W	Rx2+Tx2 0.0 W
MGA	Rx1+Tx1 3.0 W	Rx1+Tx1 3.0 W	Rx1+Tx1 3.0 W	Rx1+Tx1 3.0 W	Rx1+Tx1 3.0 W	
Power	PCDU	BOL 99.3 W / EOL 102.9 W	BOL 99.3 W / EOL 102.9 W	BOL 99.3 W / EOL 102.9 W	BOL 99.3 W / EOL 102.9 W	BOL 99.3 W / EOL 102.9 W
	Battery	2.3 W	2.3 W	2.3 W	2.3 W	2.3 W
Thruster	THR D1A	0.71	0.71	0.71	0.71	0.71
	THR D1B	0.71	0.71	0.71	0.71	0.71
	THR D2A	0.71	0.71	0.71	0.71	0.71
	THR D2B	0.71	0.71	0.71	0.71	0.71
	THR F1A	0.71	0.71	0.71	0.71	0.71
	THR F1B	0.71	0.71	0.71	0.71	0.71
	THR F2A	0.71	0.71	0.71	0.71	0.71
	THR F2B	0.71	0.71	0.71	0.71	0.71
	THR U1A	2.84	2.84	2.84	2.84	2.84
	THR U1B	2.84	2.84	2.84	2.84	2.84
	THR U2A	2.84	2.84	2.84	2.84	2.84

Sub-System	Switchable Unit	POWER DISSIPATION [W]				
		A1	A2	A3	B1	B2
		Telecom	Telecom	Telecom	Telecom	Telecom
	THR U2B	2.84	2.84	2.84	2.84	2.84
	THR A1A	4.56	4.56	4.56	4.56	4.56
	THR A1B	0.0	0.0	0.0	0.0	0.0
	THR B1A	4.56	4.56	4.56	4.56	4.56
	THR B1B	0.0	0.0	0.0	0.0	0.0
ESA Items	SREM	2.6 W	2.6 W	2.6 W	2.6 W	2.6 W
	FOG	16.5 W	16.5 W	16.5 W	26.8 W	26.8 W
		<b>duration = 3 hr</b>	<b>duration = 3 hr</b>	<b>duration = 3 hr</b>	<b>duration = 3 hr</b>	<b>duration = 3 hr</b>
HFI	DPU N	22 W	22 W	22 W	22 W	22 W
	DPU R	0.0 W	0.0 W	0.0 W	0.0 W	0.0 W
	PAU	15 W	15 W	OFF	15 W	15 W
	REU	92 W	92 W	92 W	92 W	92 W
	4K CAU	15 W	15 W	15 W	15 W	15 W
	4K CEU (4KCDE)	42.8 W	42.8 W	42.8 W	42.8 W	42.8 W
	4K PRU (4KCCR)	21 W	21 W	OFF	21 W	21 W
	4K CCU	60 W	60 W	60 W	60 W	60 W
	0.1 K DCCU	16 W	16 W	16 W	16 W	16 W
LFI		<b>duration = 3 hr</b>	<b>duration = 3 hr</b>	<b>duration = 3 hr</b>	<b>duration = 3 hr</b>	<b>duration = 3 hr</b>
	BEU Right -Y	8.77 W	OFF	8.77 W	8.77 W	8.77 W
	BEU Central	12 W	OFF	12 W	12 W	12 W
	BEU Left +Y	11 W	OFF	11 W	11 W	11 W
	DAE	13 W	OFF	13 W	13 W	13 W
	REBA N	41.5 W	41.5 W	41.5 W	41.5 W	41.5 W
	REBA R	0.0 W	0.0 W	0.0 W	0.0 W	0.0 W
SCS		<b>duration = 3 hr</b>	<b>duration = 3 hr</b>	<b>duration = 3 hr</b>	<b>duration = 3 hr</b>	<b>duration = 3 hr</b>
	SCC N	See Array values	See Array values	See Array values	See Array values	0.0 W
	SCC R	0.0 W	0.0 W	0.0 W	0.0 W	See Array values
	SCE N	110 W	110 W	110 W	110 W	0.0 W
	SCE R	0.0 W	0.0 W	0.0 W	0.0 W	110 W

Table 4.1.6-3 PLANCK – Telecom Mode Power dissipations

## 4.1.6 PLANCK Units Conductors

UNIT	NODE	PANEL	CAPACITY [J/K]	CONTACT AREA [CM <sup>2</sup> ]	CONTACT TYPE	GL [W/K]
SREM	3966	EXTERNAL +Y+Z	2160	295	Metal-Metal	0.7
SAS-X	3951	EXTERNAL -X	130	7.44	Metal-Metal	0.749 with bracket (AD14)

UNIT	NODE	PANEL	CAPACITY [J/K]	CONTACT AREA [CM <sup>2</sup> ]	CONTACT TYPE	GL [W/K]
AAD	3970	EXTERNAL -X	76.2	5.2	Metal-Metal	0.524 with bracket (AD15)
MGA-X	3986	EXTERNAL -X	69.2		Washer	0.0682 (AD17)
LGA-X	3991	EXTERNAL -X	110		Washer	0.0667 (AD16)
LGA-Y	3961	EXTERNAL -Y	110		Washer	0.0667 (AD16)
LGA+Y	3921	EXTERNAL +Y	110		Washer	0.0667 (AD16)
SAS+Y	3931	EXTERNAL +Y	130	7.44	Metal-Metal	0.749 with bracket (AD14)
RFDN	605	-Y	5150	350	Filler	2.4
EPC1	606	-Y	1230	118.5	Filler	6.06
EPC2	607	-Y	1230	118.5	Filler	3.52
TRANSX1	601	-Y	3688	109.2	Filler	5.84
TRANSX2	602	-Y	3688	109.2	Filler	5.84
TWTA1	603	-Y	448	136	Filler	3.28
TWTA2	604	-Y	448	136	Filler	3.28
CRS1	705	SHEAR -Y+Z	1523	29.6(*)	Filler	0.276
CRS2	706	SHEAR -Y+Z	1523	29.6(*)	Filler	0.119
CRS3	551	SHEAR -Y-Z	1523	29.6(*)	Filler	0.119
PCDU	704	-Y+Z	23490	1802	Filler	18.0
CDMU	701	-Y+Z	14004	551	Filler	8.35
ACC	702	-Y+Z	12400	513	Filler	8.32
BATT	703	-Y+Z	5463	19.6(*)	Filler	0.758
DPU1	13	+Z	5520	813	Filler	9.34
DPU2	14	+Z	5520	813	Filler	9.34
DCCU	101	+Y+Z	20000	5280	Filler	52.8
REBA1	102	+Y+Z	4200	510	Filler	8.5
REBA2	103	+Y+Z	4200	510	Filler	8.5
FOG (GEU)	104	SHEAR +Y+Z	3360	358	Filler	6.55
FOG (ICU)	105	SHEAR +Y+Z	1920	6 bolts	Metal-Metal	0.06
4K CAU	202	+Y	5680	1225	Filler	12.14
4K PRE REG	203	+Y	2200	400	Filler	6.87
CEU	204	+Y	4550	402	Filler	7.87
REU	205	+Y	26800	1460	Filler	13.59
4K CCU	211-232	+Y	15870	98	Filler	2.6
SCC1	311-336	+Y-Z	Array value		On Heat Pipe	63.5 each bed
SCE1	401	-Z	6800		On Heat Pipe	33.75
SCE2	402	-Z	6800		On Heat Pipe	33.75
SCC2	511-536	-Y-Z	Array value		On Heat Pipe	63.5 each bed
BEU	519	EXTERNAL SUBPLATFORM	6704	500	Filler	9.41
BEU	520	EXTERNAL SUBPLATFORM	7656	720	Filler + Doubler	9.76
BEU	521	EXTERNAL SUBPLATFORM	6704	500	Filler	9.41

UNIT	NODE	PANEL	CAPACITY [J/K]	CONTACT AREA [CM <sup>2</sup> ]	CONTACT TYPE	GL [W/K]
PAU	522	EXTERNAL SUBPLATFORM	8000	1055	Filler	10.55
DAE	525	EXTERNAL SUBPLATFORM	5032	400	Filler	1.95
Thr 1N		EXTERNAL -Y+Z	92.1		Filler	0.1
Thr 1N		EXTERNAL -Y+Z	92.1		Filler	0.1
THR1		+Z	92.1		Filler	0.8
THR2		+Y+Z	92.1		Filler	0.8
THR3		+Y-Z	92.1		Filler	0.8
THR4		-Z	92.1		Filler	0.8
THR5		-Y-Z	92.1		Filler	0.8
THR6		-Y+Z	92.1		Filler	0.8
STR1	5401-5486	+Z			Metal-Metal	1.13 / 1.65 (AD26)
STR2	5501-5586	+Z			Metal-Metal	1.13 / 1.65 (AD26)

Table 4.1.7-1 PLANCK – Units-Panels conductors

## 5 HERSCHEL & PLANCK CONDUCTIVE COUPLINGS

### 5.1 MLI conductivity

A temperature-variable conductive coupling (non linear) array simulates the MLI blanket behaviour. The different arrays used in the TMM, applicable to different MLI compositions, are given in the following Table. They are part of Alenia Spazio heritage. They are calculated with a semi-empirical curve derived from test data on Spacelab program **[RD-2.2]** and extensively used on several programs (Italsat, Artemis, Integral, MPLM, Atlantic Bird-1, Columbus, Nodes). The used semi-empirical correlation was substantially confirmed through the Thermal Balance Tests performed on the above programs and by a dedicated test on a MPLM MLI sample. By the way, Alenia used formula is in good agreement with the empirical correlation proposed in the **[RD-2.3]**. Application is:

#### HERSCHEL

- 20 layers MLI composition is used on the Top of the Satellite facing to HPLM
- 10 layers MLI composition (Type A) is used on lower panel (-X side)
- 10 layers MLI composition (Type B) is used in general on all the external surfaces
- 7 layers MLI composition is used on HIFI units, internal -Y -Z Panel, Internal -Y Panel, STR secondary baffle, STR unit, STR radiator and on the Tanks
- On the STR struts the MLI efficiency has been improved of 90% after correlation

#### PLANCK

- 20 layers MLI composition is used on the Top of the Satellite facing to PPLM and on the rear of Solar Array
- 10 layers MLI composition (Type A) is used on all the other external surfaces:
- 7 layers MLI composition is used on the Tanks and on the SCC panels
- 15 layers MLI – External layers Kapton 1 mil plus 13 layers of embossed 0.3 mil Kapton covering the Wave Guides on +Y and -Y panels (derived from Thruster impingement analysis see **[AD29]**).

Temperature [°C]	MLI CONDUCTIVITY [W/m <sup>2</sup> /°C]			
	20 Layers	10 Layers Type A	10 Layers Type B	7 Layers
-100	0.0175	0.0233	0.03495	0.0314
-90	0.0212	0.0275	0.04125	0.0362
-80	0.0251	0.0320	0.0480	0.0413
-70	0.0292	0.0366	0.0549	0.0468
-60	0.0334	0.0416	0.0624	0.0527
-50	0.0378	0.0469	0.0703	0.0590
-40	0.0424	0.0524	0.0785	0.0659
-30	0.0473	0.0584	0.0785	0.0733
-20	0.0523	0.0647	0.0785	0.0812
-10	0.0577	0.0714	0.0785	0.0898
0	0.0633	0.0785	0.0785	0.0990
10	0.0692	0.0861	0.0861	0.1088
25	0.0786	0.0984	0.0984	0.1250

Temperature [°C]	MLI CONDUCTIVITY [W/m <sup>2</sup> /°C]			
	20 Layers	10 Layers Type A	10 Layers Type B	7 Layers
30	0.0819	0.1027	0.1027	0.1308
40	0.0888	0.1118	0.1118	0.1430
50	0.0960	0.1214	0.1214	0.1560
60	0.1036	0.1317	0.1317	0.1699
70	0.1116	0.1425	0.1425	0.1848
80	0.1200	0.1540	0.1540	0.2006
90	0.1288	0.1661	0.1661	0.2174
100	0.1381	0.1789	0.1789	0.2352

Table 5-1 HERSCHEL - MLI Thermal Conductivity for different number of layers

## 5.2 Unit-Panel Conductivity

Calculation of linear conductors between units and panel is performed considering in general two contributions: the conduction due to the contact area, and the spreading effect; the last one is present when the mounting node area is bigger than contact area.

The linear conductor due to the contact area is evaluated by means of the formula:

$$GL = G_c * A_c \quad [W/°C] \quad (1)$$

Where:

### With filler

- for contact area between 30 and 1000 cm<sup>2</sup> :

$$G_c = 50000 * C_c^{-0.9} \quad (C_c = \text{contact area in cm}^2)$$

$$A_c = \text{contact area in m}^2$$

- for contact area bigger than 1000 cm<sup>2</sup> :

$$G_c = 100$$

$$A_c = \text{contact area in m}^2$$

### Without filler

for contact area between 30 and 500 cm<sup>2</sup> we have

$$G_c = 50 * \frac{800 - C_c}{150 + C_c} \quad (C_c = \text{contact area in cm}^2) \quad (2)$$

$$A_c = \text{contact area in m}^2$$

The above formulas are based on data from dedicated test performed on Olympus program (1988) and successfully used in the Alenia programs since then. Thermal Balance Test correlations of Italsat-1/2, SAX, TSS-1/2, Artemis, Integral, Atlantic Bird-1, confirmed the applicability of the used formulas.

Regards the spreading effect, the Thermal Balance Test correlations on previous programs have shown that the spreading calculation is necessary when the contact area is smaller than about 45 % of mounting node area. The spreading effect is represented by an equivalent linear conductor ( $G_{spread}$ ) that should be put in series with the linear conductor (GL) evaluated by means of the previous formulas.

For units with a small contact area by means of feet, the linear conductor for each foot will be calculated multiplying the contact area in  $m^2$  for a contact constant, considering filler, of  $2000 W/m^2/K$ . Of course the eventual spreading effect will be put in series if necessary.

When the contact area of an unit covers more than one mounting node, the spreading effect is evaluated considering the contribution of each portion of contact area on relevant mounting node (see example in Figure 5.2-1: the portion of contact area on the node number 4 is highlighted in gray).

For each mounting node the linear conductor will be calculated as series of the following conductors:

1. The linear conductor (GL) obtained proportionally at the contact area projected on the mounting node of the total linear conductor calculated by the formula (1)
2. The relevant spreading effect ( $G_{spread}$ ).

In the example of figure below, the spreading effect will be present in the mounting nodes 1,4,13 and 16 (portion of contact area less than 45% of node area) and will not be present in the mounting nodes 6,7,10 and 11. For the other nodes if the percentage of area of mounting node covered from the unit will be lower than 45% the spreading effect will be calculated otherwise no spreading effect will be present

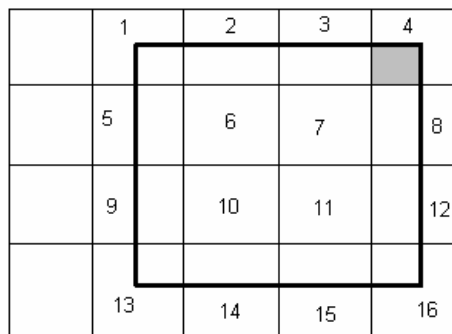

Figure 5.2-1 Unit-Panel contact areas

Details of Unit-Panel contact conductances (including spreading effect if applicable) are given in Table 3.2.2-1 for HERSCHEL and Table 3.2.2-2 for PLANCK; modified values are highlighted.

### 5.3 Honeycomb Panel Conductivity

- Conductive couplings across honeycomb panel (identified as “Z” direction) are calculated by multiplying the effective thermal conductivity  $K_z$  and the cross section between two thermal nodes (panel internal / external sides):

$$GL(int,ext) = K_z * A(node) / d$$

where

$K_z$  = thermal conductivity across the honeycomb [W/m°C]

A(node) = node area [m<sup>2</sup>]

d = overall thickness of the honeycomb panel [m]

- Lateral thermal conductance of honeycomb panel (identified as “XY” direction) is calculated by multiplying the effective thermal conductivity  $K_{xy}$  by the cross section and dividing it by the distance between the two thermal nodes.

$$GL(xxx,yyy) = K_{XY} * A(\text{cross section}) / d$$

where

$K_{XY}$  = in plane conductivity of the honeycomb

A(cross section) = cross section between the two nodes

d = distance of the center of mass of the two adjacent nodes

Structural characteristics and thermal conductivity ( $K_{xy}$  and  $K_z$ ) of the panels are reported in table 5.3-1 for HERSCHEL and 5.3-2 for PLANCK (note: the conductivity evaluation has been made as per [RD2-1]).

LOCATION	H/C TYPE	SKIN TYPE	SKIN Conducib. [W/mK]	SKIN THICK. [mm]	CORE THICK. [mm]	$K_{XY}$ [W/mK]	$K_z$ [W/mK]
Upper and Lower Closure	3/16-5056-.0007	M18/G801	20	0.4	20	1.21	1.19
Lateral	3/16-5056-.0007	AA7075T6	130	0.3	35	2.64	1.17*1.4 = 1.64
Top Platform central disc	3/16-5056-.0007	M18/G801	20	0.3	20	1.03	1.18
Shear Web	3/16-5056-.001	M18/G969	20	0.76	15	2.43	1.78
Cone	3/16-5056-.001	M40/914	20	0.54	15	1.95	1.74
Reinforced Cone	1/8-5056-.002	M40/914	20	1.08	13.92	4.39	5.32
STR baseplate +X	3/16-5056-.0007	HCF(*)	350 eq	2	55	24.15	1.25
STR baseplate -X	3/16-5056-.0007	HCF(*)	350 eq	3	55	34.84	1.25

(\*) High conductivity Carbon Fiber.

Table 5.3-1 HERSCHEL – SVM Honeycomb panels & structural parts thermal properties

LOCATION	H/C TYPE	SKIN TYPE	SKIN Conducib. [W/mK]	SKIN THICK. [mm]	CORE THICK. [mm]	$K_{XY}$ [W/mK]	$K_z$ [W/mK]
Top & Bottom Floor	3/16-5056-.0007	M18/G801	20	0.4	20	1.21	1.19
Radiator Panels and SCC Panels	3/16-5056-.0007	AA7075T6	130	0.3	35	2.64	1.17
Radiator Panel +Y	3/16-5056-.0007	AA7075T6	130	0.6	35	4.75	1.19
Payload Subplatform	3/16-5056-.0007	AA7075T6	130	0.3	19.4	4.34	1.18
Shear Web	3/16-5056-	M18/G969	20	0.76	15	2.25	1.26



	.0007						
Cone	3/16-5056-.001	M40/914	20	0.54	15	1.95	1.74
Reinforced Cone	1/8-5056-.002	M40/914	20	1.08	13.92	4.39	5.32
Solar Array	Al	M55	20	0.18	20	0.825	1.31

Table 5.3-2 PLANCK – SVM Honeycomb panels thermal properties

Struts to CVV are made in glass fiber with titanium blade, the K is variable as in the following table:

<b>GLASS FIBER CONDUCTIVITY</b>	
<b>T</b> <b>[°C]</b>	<b>K</b> <b>[W/mK]</b>
-150	0.38
-140	0.40
-110	0.44
-90	0.48
-70	0.55
-50	0.64
-30	0.75

Table 5.3-3 HERSCHEL – SVM struts conductivity

#### 5.4 Doubler – panel conductivity

The linear conductor between doubler and panels has been calculated by means the  $3000 \cdot A_c$ . In the linear conductor computation the spreading effect has not been considered because the doubler nodes have the same sizing of the underlying panel nodes.

#### 5.5 Cleats linear conductivity

The linear couplings between panels and between panels and platforms have been calculated between the two elements (1 and 2 in Figure 5.5-1) as a serie of three linear thermal conductors:

- GL of half part of the element 1 =  $K \cdot A / d$
- GL of the link cleat or insert
- GL of half part of element 2 =  $K \cdot A / d$

The contact conductance and the screw conductance are added and put in serie with the cleat material conductance to evaluate the global linear conductance GL due to the link.

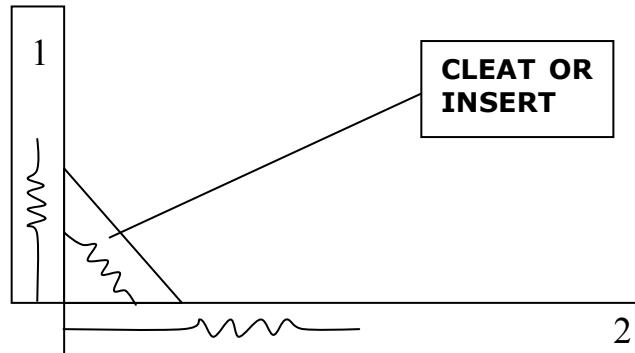

Figure 5.5-1 Cleats conductors

The GL has been calculated studying the different geometry and the different type of contact for each cleat or insert; the drawings are given in [AD3]. In Table 5.5-1 a list of GL for different cleats/insert geometries is given:

LINKED PANELS	TYPE OF LINK	GL [W/K]
<b>HERSCHEL</b>		
Lateral panel-lateral panel	CLEAT1	0.39
Lateral panel-lateral panel -Y and -Y-Z	WCLEAT1	0.08
Lateral panel-top floor and lateral panel-bottom floor	INSERT	0.21
Lateral panel-top floor and lateral panel-bottom floor -Y and -Y-Z	WINSERT	0.1
Shear web-top floor and shear web-bottom floor	INSERT1	0.32
Shear web-lateral panel	INSERT2	0.33
Shear web-lateral panel -Y	WINSERT2	0.09
Shear web-cone	CLEAT2	0.43
Cone-bottom floor	CLEAT3SCREW	0.36
Cone-bottom floor -Y and -Y-Z	CLEAT4SCREW	0.48
Adaptor ring-bottom closure panel	CLEAT_ADAPT_RCS	0.43
<b>PLANCK</b>		
SCC panel - Top, Bottom and Shear Web	KINSERT3	0.0185
SCC panel - other Lateral Panels	CLEAT3	0.031

Table 5.5-1 Cleats and inserts linear conductors

## 5.6 PLANCK Heat Pipes conductivity

The heat pipes network has been performed as reported in [AD8] with the following updating coming from the CDR discussion:

- **Correction of thermal capacity**  
RID CDR-TCS-ASP-ENG-067

ALS has again calculated, using the data from the EHP MRR DP, the updated value for the thermal capacity. The new data are:

Horizontal H.P. 400 J/K*m	was 800 J/K*m
Vertical H.P. 360 J/K*m	was 420 J/K*m

- **Correct GL HP vertical I/F – HP vertical evaporator**  
RID CDR-TCS-ASP-ENG-064

ALS update the GL between HP vert.I/F(nodes 811-825, 861-875) and HP vert. Evaporator (nodes 8011-8025, 8061-8075) considering a contact area for each conductor of  $(0.0508 + \text{spreading } 45^\circ) * 0.025 = 1.645e-03 \text{ m}^2$ . Previous value was computed considering a contact area for each conductor of  $(0.78 * 0.025) = 19.5e-03 \text{ m}^2$ .

- **Consider GL HP vertical I/F at the extremity**  
RID CDR-TCS-ASP-ENG-109

ALS update the TMM considering the GL between the HP vert. I/F at the extremity (nodes 811,826,861,876) and the SCC Outer Shell (nodes 311-316, 511-516) reduced by half due to the reduced contact area of the HP located at the extremity.

- **Heat pipes conductive couplings**  
RID CDR-TCS-ASP-ENG-121

The conductors between HP hor (nodes 801-808, 851-858) and SCC radiators have been updated considering the dimension taken from the EHP drawings issued on 1<sup>st</sup> March 2004. The values are:

Nodes 801-808 to SCC panel +Y-Z :	$G_c = 50000 * A_c^{-0.9} = 222 \text{ W/m}^2$	was 213.27 W/m <sup>2</sup>
Nodes 801-808 to SCC panel -Z :	$G_c = 50000 * A_c^{-0.9} = 304.88 \text{ W/m}^2$	was 324.14 W/m <sup>2</sup>
Nodes 851-858 to SCC panel -Y-Z :	$G_c = 50000 * A_c^{-0.9} = 220.7 \text{ W/m}^2$	was 213.27 W/m <sup>2</sup>

## 5.7 PLANCK Solar Array conductivity

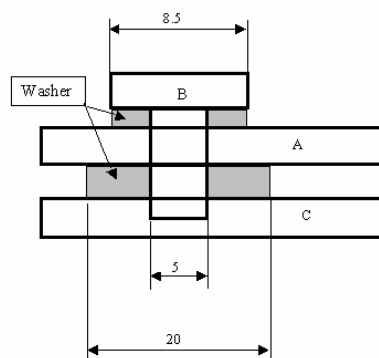

Figure 5.7-1 PLANCK – Connection via screw

### External Solar Array

Each external solar array panel has two kinds of connections:

1. External solar array panel with Lower Closure Panel
2. External solar array panel with Lateral Panel by means a bracket

#### 1) External solar array panel with Lower Closure Panel

For each first kind connection is used (12 points in total):

- One thermal washer in vetronite (thickness 1 mm) under the screw head;
- One thermal washer in vetronite (thickness 19 mm) in the I/F between Solar array panel and lower closure panel

On the basis of figure 3.2.7-1 we have:

- between A and B a vetronite washer of 1 mm
- between A and C a vetronite washer of 19 mm
- K screw : 15 W/m °C; K washer: 0.288 W/m<sup>2</sup> °C
- thickness A (solar array) 25 mm

$$GL\ A-B = 0.0107\ W/^{\circ}C$$

$$GL\ B-C\ (by\ screw) = 0.0065\ W/^{\circ}C$$

Therefore the GL A-C, between the parts A and C (by screw), is the series of GL A-B and GL B-C.

$$GL\ A-C\ (by\ screw) = 0.0041\ W/^{\circ}C$$

$$GL\ A-C\ (by\ washer) = 0.0045\ W/^{\circ}C$$

$$GL\ A-C\ (total) = \mathbf{0.0085\ W/^{\circ}C}$$
 for each screw.

2) External solar array panel with Lateral Panel by means a bracket

For each second kind connection is used (16 points in total):

- One thermal washer in vetronite (thickness 1 mm) under the each screw head;
- One thermal washer in vetronite (thickness 5 mm) for each screw, in the I/F between external Solar Array panel and Solar Array lateral bracket.
- One thermal washer in vetronite (thickness 3 mm) for each screw between Solar Array lateral bracket and lateral panel

For each point the Solar array is connected to panels by means a bracket in titanium fixed to solar array with 4 titanium screws M5 (GL1) and to panels with 3 titanium screws M5 (GL2). Considering the linear conductor of the bracket as GL3, the total linear conductor between solar array and panel is the series of GL1, GL2 and GL3.

On the basis of figure 3.2.7-1 we have:

**GL1** (external solar array with bracket):

- between A and B a vetronite washer of 1 mm
- between A and C a vetronite washer of 5 mm
- K screw : 15 W/m °C; K washer: 0.288 W/m<sup>2</sup> °C
- thickness A (bracket) 3 mm

$$GL\ A-B = 0.0107\ W/^{\circ}C$$

$$GL\ B-C\ (by\ screw) = 0.0327\ W/^{\circ}C$$

Therefore the GL A-C, between the parts A and C (by screw), is the series of GL A-B and GL B-C.

$$GL\ A-C\ (by\ screw) = 0.0081\ W/^{\circ}C$$

$$GL\ A-C\ (by\ washer) = 0.0170\ W/^{\circ}C$$

$$GL1 = GL\ A-C\ (total) = 0.0250\ W/^{\circ}C. \text{ Considering } 4\ screws = 0.1\ W/^{\circ}C$$

**GL2** (by bracket):

- In titanium (K=15 W/m °C)
- width: 90 mm
- thickness: 3 mm
- Length: 300 mm

$$GL2 = 0.0135\ W/^{\circ}C$$

**GL3** (panel and bracket)

- between A and B a vetronite washer of 1 mm
- between A and C a vetronite washer of 3 mm
- K screw: 15 W/m/°C; K washer: 0.288 W/m<sup>2</sup> °C
- thickness A (bracket) 3 mm

$$GL\ A-B = 0.0107\ W/^{\circ}C$$

$$GL\ B-C\ (by\ screw) = 0.0421\ W/^{\circ}C$$

Therefore the GL A-C, between the parts A and C (by screw), is the series of GL A-B and GL B-C.

$$GL\ A-C\ (by\ screw) = 0.0085\ W/^{\circ}C$$

GL A-C (by washer) = 0.0283 W/°C

GL3 = GL A-C (total) = 0.0368 W/°C. Considering 3 screws = 0.1104 W/°C

The total GL as series of GL1, GL2 and GL3 = **0.0107 W/°C**

A sketch of the connections is reported below.

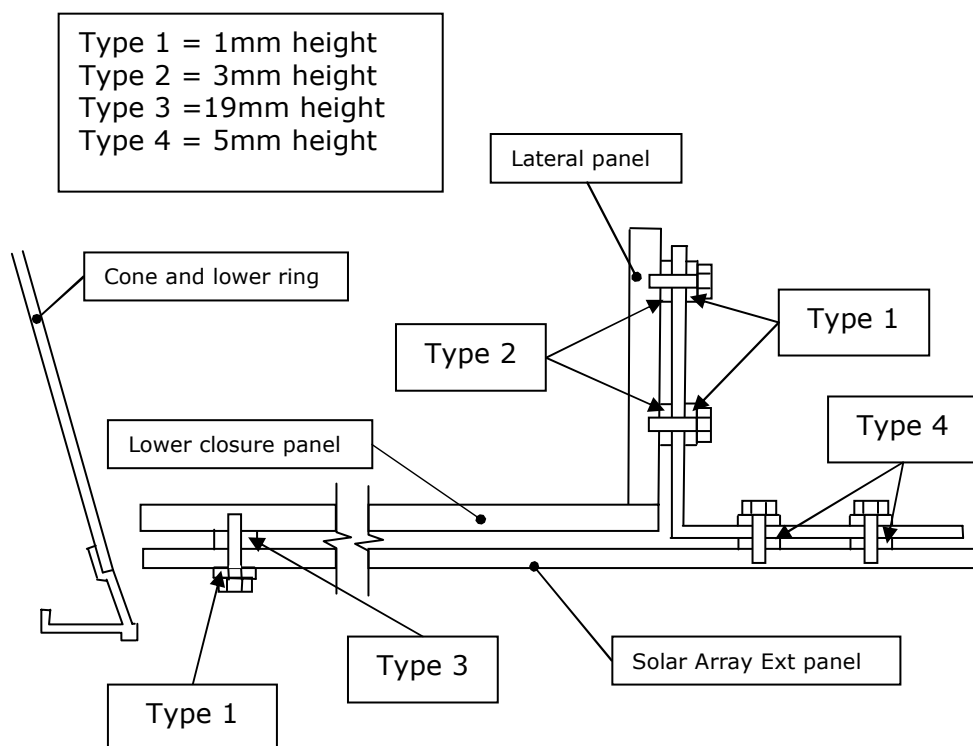

Figure 5.7-2 PLANCK – Connection Solar Array-Lateral panel

### Central Solar Array

The central Solar array is connected by means 12 aluminum brackets to internal cone. I/F between bracket and solar array is performed by means a titanium screw M5 with a vetronite washer of 2 mm under the head screw and a vetronite washer of 5 mm between solar array and bracket. I/F between bracket and cone is performed by means 4 steel screws (K=36 W/m/°C). Each screw has a vetronite washer of 3 mm between bracket and cone. The total linear conductor is obtained as series of linear conductors of the bracket and of the two connections: solar array side and cone side.

On the basis of figure 3.2.7-1 we have:

**GL1** (between bracket and cone):

- between A and B no washer (assumed a contact conductivity of 1000 W/m<sup>2</sup> °C)

- between A and C a vetronite washer of 3 mm
- K screw : 36 W/m °C; K washer: 0.288 W/m<sup>2</sup> °C
- thickness A (bracket) 3 mm

$$GL\ A-B = 0.0371\ W/^{\circ}C$$

$$GL\ B-C\ (by\ screw) = 0.1178\ W/^{\circ}C$$

Therefore the GL A-C, between the parts A and C (by screw), is the series of GL A-B and GL B-C.

$$GL\ A-C\ (by\ screw) = 0.0282\ W/^{\circ}C$$

$$GL\ A-C\ (by\ washer) = 0.0283\ W/^{\circ}C$$

$$GL1 = GL\ A-C\ (total) = 0.0565\ W/^{\circ}C. \text{ Considering 4 screws} = 0.226\ W/^{\circ}C$$

**GL2 (by bracket):**

- In aluminum (K=150 W/m °C)
- width: 115 mm
- thickness: 3 mm
- Length: 100 mm

$$GL2 = 0.518\ W/^{\circ}C$$

**GL3 (solar array and bracket)**

- between A and B a vetronite washer of 2 mm
- between A and C a vetronite washer of 5 mm
- K screw: 15 W/m/°C; K washer: 0.288 W/m<sup>2</sup> °C
- thickness A (bracket) 3 mm

$$GL\ A-B = 0.0053\ W/^{\circ}C$$

$$GL\ B-C\ (by\ screw) = 0.0295\ W/^{\circ}C$$

Therefore the GL A-C, between the parts A and C (by screw), is the series of GL A-B and GL B-C.

$$GL\ A-C\ (by\ screw) = 0.0045\ W/^{\circ}C$$

$$GL\ A-C\ (by\ washer) = 0.0170\ W/^{\circ}C$$

$$GL3 = GL\ A-C\ (total) = 0.0215\ W/^{\circ}C.$$

The total GL as series of GL1, GL2 and GL3 = **0.0189 W/°C**; a sketch of the connections is reported below.

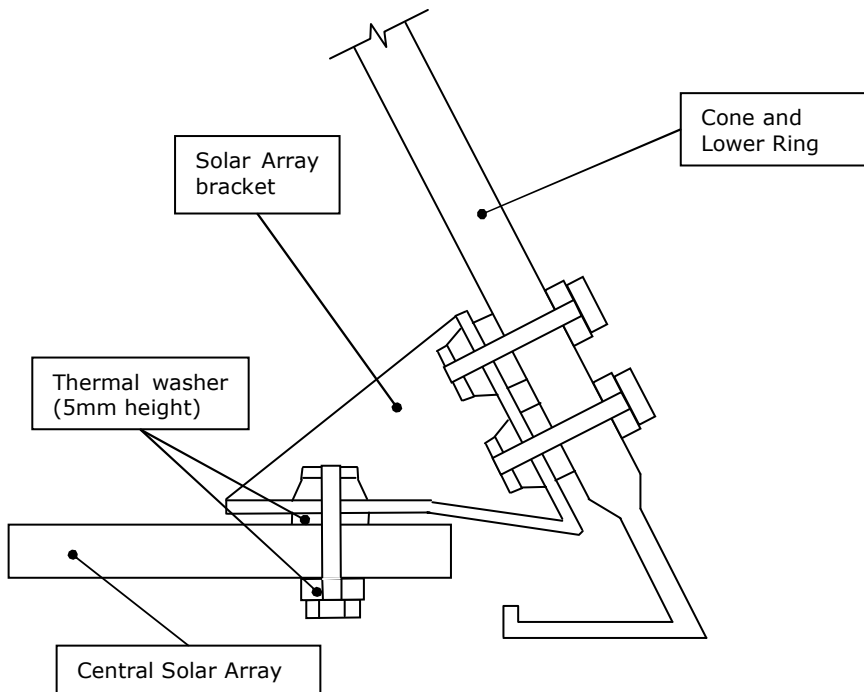

Figure 5.7-3 PLANCK – Connection Solar Array-Cone



## 6 HERSCHEL & PLANCK MASS UPDATING

The thermal capacities of HERSCHEL and PLANCK satellites have been updated on the basis of the:

- BEE mechanical mass budget (H-P-BD-AI-0006 issue 2) relatively to the masses used to define the thermal capacity of the structure (panel, shear web, cone, adaptor ring etc.)
- Thermal ICD or dedicated RTMM relatively to the unit thermal capacities.

Starting from the mechanical mass budget, the masses (subdivide for panel) of the structure, brackets, filler, paint, radiator and harness have been identified and reported in the tables 6-2 for Herschel and 6-3 for Planck.

In the table 6-1 the comparison between the total mass of the satellites derived from mechanical mass budget and the total equivalent mass derived from the TMM is shown.

	Total BEE Mass Budget [Kg]	Total thermal Capacity in TMM [J/°C]	Equivalent Mass of thermal Capacity [Kg] (*)
HERSCHEL	891	742268	825
PLANCK	1103	841289	935

(\*) considering a heat capacity of 900 J/Kg °C

Table 6-1 PLANCK – Summary mass comparison between TMM and mechanical mass budget

Description	Node	Brackets, filler, paint, radiator [Kg]	Harness [Kg]	SVM structure [Kg]	SVM Spread [Kg]	Thermal Capacity [J/°C] (*)
Panel +Z	30XX,60XX	0.13		6.3	7.02	12105
Panel +Y+Z	31XX, 61XX	0.34	3.27	4.99	4.67	10962
Panel +Y	32XX, 62XX	1.43	21.02	7.12	7.02	26625
Panel +Y-Z	33XX, 63XX	0.37	2.81	4.93	4.67	10659
Panel -Z	34XX, 64XX	0.39	3.7	7.4	7.02	15549
Panel -Y-Z	35XX, 65XX	0.23	3.66	5.36	4.67	11430
Panel -Y	36XX, 66XX	0.44	3.66	8.07	7.02	16173
Panel -Y+Z	37XX, 67XX	0.69	1.24	5	4.67	10068
Shear Web +Y(+Z)	526X	0.1		2.72		2538
Shear Web +Y(-Z)	528X			2.51		2259
Shear Web +Z(+Y)	507X	0.18		2.36		2286
Shear Web +Z(-Y)	505X	1.66		2.84		4050
Shear Web -Y(+Z)	568X			2.51		2259
Shear Web -Y(-Z)	566X			2.88		2592
Shear Web -Z(+Y)	546X			1.97		1773
Shear Web -Z(-Y)	548X			1.93		1737
Adaptor ring	201X,211X,202X, 212X,200X,210X, 205X,215X	3.6		32.5		32490
Cone	25XX,26XX			53.8		48420
Lower Closure	16XX	7	42.43	26.62		55716
Subplatform	24XX			5.29		4761
TH closure struct.	74XX	1.28		5.17		5805
Upper Closure	76XX	41.23	34.18	29.37		84048
Attached point	27XX			23.6		21240
Total		59.07	115.97	245.24	46.76	385545

(\*) Considering the following specific heat: 600 J/Kg/°C for the harness; 900 J/Kg/°C for the other parts

Table 6-2 HERSCHEL – Mass Updating from BEE mechanical mass budget

Should be noted that Herschel Star Tracker baseplate has been considered, in the TMM, with a thermal capacity of 3597 J/°C, corresponding to a mass of 4.9 Kg. In the mechanical mass budget the mass of the STR structure with harness and bracket is of 5.43 Kg. About the star tracker unit the same mass has been considered both in the TMM and in the mechanical mass budget (3.12 Kg).

Description	Node	Brackets, filler, paint, radiator [Kg]	Harness [Kg]	SVM structure [Kg]	SVM Spread [Kg]	Thermal Capacity [J/°C] (*)
Panel +Z	30XX,60XX	0.29	2.8	4.16	7.25	12210
Panel +Y+Z	31XX, 61XX	0.26	5.48	7.26	10.87	19839
Panel +Y	32XX, 62XX	0.29	8.47	4.72	7.25	16116
Panel +Y-Z	33XX, 63XX	0.18		7.47	10.87	16668
Panel -Z	34XX, 64XX	0.09	1.43	4.66	7.25	11658
Panel -Y-Z	35XX, 65XX	0.18	2	7.13	10.87	17562
Panel -Y	36XX, 66XX	0.25	3.42	4.68	7.25	13014
Panel -Y+Z	37XX, 67XX	0.84	24.78	6.89	10.87	31608
Shear Web +Y+Z(+Z)	515X,516X	0.01	6.21	2.85		6300
Shear Web +Y-Z(+Y)	525X,526X	0.7		2.85		3195
Shear Web +Y-Z(-Z)	527X,528X			2.69		2421
Shear Web -Y+Z(+Z)	507X,508X			2.46		2214
Shear Web +Y+Z(+Y)	517X,518X	0.45		2.59		2736
Shear Web -Y+Z(-Y)	505X,506X	0.21		2.73		2646
Shear Web -Y-Z(-Y)	535X,536X			2.74		2466
Shear Web -Y-Z(-Z)	537X,538X	0.24		2.63		2583
Adaptor ring	2XXX	3.4		32.5		32310
Cone	25XX,26XX	0		68.44		61596
Lower panel	16XX	6.68	40.26	19.45		47673
Subplatform	73XX,74XX,27XX	0.28	24.5	51		60852
Upper closure	76XX			21.08		18972
Attached point	1002X			15.9		14310
<b>Total</b>		14.35	119.35	276.88	72.48	398949

(\*) Considering the following specific heat: 600 J/Kg/°C for the harness; 900 J/Kg/°C for the other parts

Table 6-3 PLANCK – Mass Updating from BEE mechanical mass budget

## 7 SVM INTERFACE REQUIREMENTS

### 7.1 Herschel requirements

The HERSCHEL SVM interface requirements are listed below:

REQUIR.	DESCRIPTION	RESULT	STATUS (*)
ITP-030-H	CVV total negative conductive loads onto the SVM of 5W uniformly distributed on each point	Total negative flux of 5W on the 12 I/F CVV POINTS (2701÷2712) in the TMM	C
ITS-021-H	Sunshield total positive loads onto SVM of 5W from Sunshield CFRP struts and 10W from Sunshield brackets uniformly distributed on each point	Total positive flux of 5W on the 3 I/F SUNSHIELD STRUTS (2715÷2717) and 10W on the 2 I/F SUNSHIELD BRACKETS (2713-2714) in the TMM	C
ITP-040-H	SVM shield total negative loads onto SVM of 1W uniformly distributed on each point	Total negative flux of 1W on the 14 I/F SVM SHIELD POINTS (2718÷2731) in the TMM	C
ITP-050-H	Total negative loads onto FHLSU via waveguides of 1W	Total negative flux of 1W on the FHLSU (605) in the TMM	C
ITP-060-H	Negative heat loads onto the SVM connector brackets of the upper panels < 1W	connector brackets not modelled	N/A
ITP-090-H	MLI on top SVM max decoupling	Low Emissivity ( $\epsilon=0.05$ ) and MLI 20 layers used	C
ITP-100-H	MLI on top SVM composition $\epsilon < 0.05$ , infra-red specular ratio $> 90\%$ , $\alpha 0.13 \pm 0.02$ , solar specular reflectivity $0.82 \pm 0.02$ and external layer T average (weighted by areas) < 220K (-43.6°C) for any pitch in the range [-30°,0°]	Composition and T < 220K for nodes 7001÷7078 and 7201÷7260 for any pitch in the range [-30°,0°] Average Temp = -38 °C (Table 7.1-2)	NC
ITP-120-H	CVV truss attachment points T < 293K (20°C) for any pitch in the range [-30°,0°]	T < 293K on the 4 I/F CVV POINTS for any pitch in the range [-30°,0°] Average Temp = 23.6 °C (Table 7.1-3)	NC
ITP-130-H	SVM shield attachment points T < 293K (20°C) for any pitch in the range [-30°,0°]	T < 293K on 6 I/F SVM SHIELD POINTS for any pitch in the range [-30°,0°] Average Temp = 21.4 °C (Table 7.1-4)	NC
ITP-135-H	Thermal conductive leak from the STR Assembly to HPLM < 150mW	Flux to CVV (Table 7.1-5)	C
ITI-020-H	Temp. design range and stability req.	Stability results: see Tables 7.1-6/7	PC
		Temp. design range: see conclusions	C
ACP-060-H	Maximum rate of temperature variation not exceeding 0.25 °C/100 sec at STR mounting plate	Detail see AD23 (Table 7.1-7/8)	C
	Amplitude of temperature variation within 0.5 °C around any setpoint of STR	Detail see AD23 (Table 7.1-9/10)	PC

	The maximum temperature gradient generated by STR at baseplate between mounting feet $\leq 0.4$ °C	Detail see AD23 (fig. 7.1-1 and 7.1-2)	C
THP-095-H	During observation period max temperature gradient between SVM/PLM I/F point $< 8$ °C	Table 7.1-13	C

(\*) C=Compliance; NC= Not Compliance; PC= Partially Compliance

Table 7.1-1 HERSCHEL – Requirements

### ITP-100-H

SVM Top external layer T average (wighted by areas)  $< 220$ K ( $-53$ °C) for the hottest pitch in the range  $[-30,0^{\circ}]$  and for the hottest dissipation case: EOL in Winter pitch  $0^{\circ}$  and Telecom MODE1

<b>HERSCHEL ITP-100-H</b>						
<b>WORST CASE: EOL Rotx=-1 Roty=0 Winter Telecom MODE1</b>						
<b>NODE</b>	<b>LABEL</b>	<b>T [°C]</b>	<b>UFP [°C]</b>	<b>T+UFP [°C]</b>	<b>AREA [m<sup>2</sup>]</b>	<b>(T+UFP)*AREA [°C*m<sup>2</sup>]</b>
7001	MLI SVM Top +Z	-52.45	24.6	-27.85	0.1385	-3.86
7002	MLI SVM Top +Z	-42.74	21.6	-21.14	0.1385	-2.93
7003	MLI SVM Top +Z	-50.77	24.4	-26.37	0.0703	-1.85
7004	MLI SVM Top +Z	-41.2	21.4	-19.8	0.0703	-1.39
7005	MLI SVM Top +Z	-50.25	24.3	-25.95	0.0703	-1.83
7006	MLI SVM Top +Z	-40.11	21.5	-18.61	0.0703	-1.31
7007	MLI SVM Top +Z	-51.27	24.7	-26.57	0.1385	-3.68
7008	MLI SVM Top +Z	-39.34	21.5	-17.84	0.1385	-2.47
7011	MLI SVM Top +Y+Z	-53.33	24.5	-28.83	0.0801	-2.31
7012	MLI SVM Top +Y+Z	-40.21	21.4	-18.81	0.1015	-1.91
7013	MLI SVM Top +Y+Z	-53.82	24.6	-29.22	0.0530	-1.55
7014	MLI SVM Top +Y+Z	-41.87	21.8	-20.07	0.1591	-3.19
7015	MLI SVM Top +Y+Z	-55.1	24.8	-30.3	0.0530	-1.61
7016	MLI SVM Top +Y+Z	-47.3	23.2	-24.1	0.1591	-3.83
7017	MLI SVM Top +Y+Z	-56.01	25	-31.01	0.0801	-2.48
7018	MLI SVM Top +Y+Z	-53.79	25.1	-28.69	0.1015	-2.91
7021	MLI SVM Top +Y	-59.38	25.4	-33.98	0.1385	-4.71
7022	MLI SVM Top +Y	-59.76	25.6	-34.16	0.1385	-4.73
7023	MLI SVM Top +Y	-60.96	25.3	-35.66	0.0703	-2.51
7024	MLI SVM Top +Y	-61.55	25.5	-36.05	0.0703	-2.54
7025	MLI SVM Top +Y	-61.7	25.4	-36.3	0.0703	-2.55
7026	MLI SVM Top +Y	-62.11	25.7	-36.41	0.0703	-2.56
7027	MLI SVM Top +Y	-62.7	25.6	-37.1	0.1385	-5.14
7028	MLI SVM Top +Y	-62.37	26	-36.37	0.1385	-5.04
7031	MLI SVM Top +Y-Z	-64.94	25.7	-39.24	0.0801	-3.14
7032	MLI SVM Top +Y-Z	-66.8	25.9	-40.9	0.1015	-4.15
7033	MLI SVM Top +Y-Z	-64.96	25.8	-39.16	0.0530	-2.08
7034	MLI SVM Top +Y-Z	-66.47	26	-40.47	0.1591	-6.44
7035	MLI SVM Top +Y-Z	-64.5	25.8	-38.7	0.0530	-2.05
7036	MLI SVM Top +Y-Z	-63.51	25.8	-37.71	0.1591	-6.00
7037	MLI SVM Top +Y-Z	-64.57	25.8	-38.77	0.0801	-3.10

<b>HERSCHEL ITP-100-H</b>						
<b>WORST CASE: EOL Rotx=-1 Roty=0 Winter Telecom MODE1</b>						
<b>NODE</b>	<b>LABEL</b>	<b>T [°C]</b>	<b>UFP [°C]</b>	<b>T+UFP [°C]</b>	<b>AREA [m<sup>2</sup>]</b>	<b>(T+UFP)*AREA [°C*m<sup>2</sup>]</b>
7038	MLI SVM Top +Y-Z	-63.91	26	-37.91	0.1015	-3.85
7039	MLI SVM Top +Y-Z	-65.67	26	-39.67	0.1385	-5.49
7040	MLI SVM Top +Y-Z	-65.18	26.1	-39.08	0.1385	-5.41
7041	MLI SVM Top -Z	-67.02	26	-41.02	0.0703	-2.89
7042	MLI SVM Top -Z	-66.85	26.1	-40.75	0.0703	-2.87
7043	MLI SVM Top -Z	-67.01	26.2	-40.81	0.0703	-2.87
7044	MLI SVM Top -Z	-67	26.2	-40.8	0.0703	-2.87
7051	MLI SVM Top -Z-Y	-66.67	26.1	-40.57	0.1385	-5.62
7052	MLI SVM Top -Z-Y	-66.04	26.3	-39.74	0.1385	-5.50
7053	MLI SVM Top -Z-Y	-66.44	26.1	-40.34	0.0801	-3.23
7054	MLI SVM Top -Z-Y	-66.5	26.2	-40.3	0.1015	-4.09
7055	MLI SVM Top -Z-Y	-66.53	26	-40.53	0.0530	-2.15
7056	MLI SVM Top -Z-Y	-68.99	25.3	-43.69	0.1591	-6.95
7057	MLI SVM Top -Z-Y	-66.28	25.9	-40.38	0.0530	-2.14
7058	MLI SVM Top -Z-Y	-67.03	25.6	-41.43	0.1591	-6.59
7059	MLI SVM Top -Y	-65.64	25.8	-39.84	0.0801	-3.19
7060	MLI SVM Top -Y	-66.32	25.8	-40.52	0.1015	-4.11
7061	MLI SVM Top -Y	-63.43	26	-37.43	0.1385	-5.18
7062	MLI SVM Top -Y	-62.82	25.4	-37.42	0.1385	-5.18
7063	MLI SVM Top -Y	-62.97	26	-36.97	0.0703	-2.60
7064	MLI SVM Top -Y	-62.06	25.1	-36.96	0.0703	-2.60
7065	MLI SVM Top -Y	-61.7	25.9	-35.8	0.0703	-2.52
7066	MLI SVM Top -Y	-60.99	24.8	-36.19	0.0703	-2.55
7067	MLI SVM Top -Y	-60.24	25.8	-34.44	0.1385	-4.77
7068	MLI SVM Top -Y	-58.77	25.5	-33.27	0.1385	-4.61
7071	MLI SVM Top -Y+Z	-56.94	25.5	-31.44	0.0801	-2.52
7072	MLI SVM Top -Y+Z	-53.17	25.5	-27.67	0.1015	-2.81
7073	MLI SVM Top -Y+Z	-56.14	25.2	-30.94	0.0530	-1.64
7074	MLI SVM Top -Y+Z	-48.17	23.2	-24.97	0.1591	-3.97
7075	MLI SVM Top -Y+Z	-55.29	25.1	-30.19	0.0530	-1.60
7076	MLI SVM Top -Y+Z	-46.4	22.2	-24.2	0.1591	-3.85
7077	MLI SVM Top -Y+Z	-54.2	25	-29.2	0.0801	-2.34
7078	MLI SVM Top -Y+Z	-43.81	21.7	-22.11	0.1015	-2.25
7200	MLI SVM Top Disc Int +Z	-55.91	24.6	-31.31	0.5144	-16.11
7201	MLI SVM Top Disc Int +Z+	-58.06	24.9	-33.16	0.1580	-5.24
7202	MLI SVM Top Disc Int +Y	-61.76	25.4	-36.36	0.5144	-18.71
7203	MLI SVM Top Disc Int +Y-	-66.57	26.3	-40.27	0.3250	-13.09
7204	MLI SVM Top Disc Int -Z	-67.44	26.6	-40.84	0.1787	-7.30
7205	MLI SVM Top Disc Int -Z-	-66.85	26.4	-40.45	0.3216	-13.01
7206	MLI SVM Top Disc Int -Y	-61.84	25.7	-36.14	0.5144	-18.59
7207	MLI SVM Top Disc Int -Y+	-58.26	25	-33.26	0.1580	-5.26
7210	MLI Cyl STR Int +Z	-57.63	22.9	-34.73	0.2513	-8.73
7211	MLI Cyl STR Int +Z+Y	-57.77	23.2	-34.57	0.0771	-2.67
7212	MLI Cyl STR Int +Y	-62.63	22.2	-40.43	0.2513	-10.16

<b>HERSCHEL ITP-100-H</b>						
<b>WORST CASE: EOL Rotx=-1 Roty=0 Winter Telecom MODE1</b>						
<b>NODE</b>	<b>LABEL</b>	<b>T [°C]</b>	<b>UFP [°C]</b>	<b>T+UFP [°C]</b>	<b>AREA [m<sup>2</sup>]</b>	<b>(T+UFP)*AREA [°C*m<sup>2</sup>]</b>
7213	MLI Cyl STR Int +Y-Z	-60.83	22.3	-38.53	0.1586	-6.11
7214	MLI Cyl STR Int -Z	-61.48	22.2	-39.28	0.0880	-3.46
7215	MLI Cyl STR Int -Z-Y	-61.28	22.7	-38.58	0.1580	-6.10
7216	MLI Cyl STR Int -Y	-62.72	22.3	-40.42	0.2513	-10.16
7217	MLI Cyl STR Int -Y+Z	-58.17	23.3	-34.87	0.0771	-2.69
7220	MLI Disc STR Int +Z	-91.68	15.1	-76.58	0.1853	-14.19
7221	MLI Disc STR Int +Z+Y	-82.62	17.2	-65.42	0.0569	-3.72
7222	MLI Disc STR Int +Y	-76.81	17.9	-58.91	0.1853	-10.92
7223	MLI Disc STR Int +Y-Z	-101.28	17.1	-84.18	0.1170	-9.85
7224	MLI Disc STR Int -Z	-69.36	18.4	-50.96	0.0647	-3.30
7225	MLI Disc STR Int -Z-Y	-92.5	17.7	-74.8	0.1161	-8.69
7226	MLI Disc STR Int -Y	-78.4	18	-60.4	0.1853	-11.19
7227	MLI Disc STR Int -Y+Z	-84.2	17.1	-67.1	0.0569	-3.82
7230	MLI Rec STR dx	-81.1	23	-58.1	0.0101	-0.59
7231	MLI Rec STR dx	-82.72	21	-61.72	0.0101	-0.62
7232	MLI Rec STR dx	-83.16	20	-63.16	0.0101	-0.64
7233	MLI Rec STR dx	-83.17	18.9	-64.27	0.0101	-0.65
7234	MLI Rec STR dx	-82.89	18.4	-64.49	0.0101	-0.65
7235	MLI Rec STR dx	-82.87	18.1	-64.77	0.0101	-0.65
7236	MLI Rec STR dx	-81.69	18.1	-63.59	0.0101	-0.64
7237	MLI Rec STR dx	-80.58	18.4	-62.18	0.0101	-0.63
7238	MLI Rec STR dx	-79.46	18.8	-60.66	0.0101	-0.61
7239	MLI Rec STR dx	-77.67	20.4	-57.27	0.0101	-0.58
7240	MLI Rec STR dx	-74.65	21.4	-53.25	0.0101	-0.54
7250	MLI Rec STR sx	-81.26	23	-58.26	0.0101	-0.59
7251	MLI Rec STR sx	-82.83	21.1	-61.73	0.0101	-0.62
7252	MLI Rec STR sx	-83.36	19.9	-63.46	0.0101	-0.64
7253	MLI Rec STR sx	-83.14	19	-64.14	0.0101	-0.65
7254	MLI Rec STR sx	-82.88	18.1	-64.78	0.0101	-0.65
7255	MLI Rec STR sx	-82.99	17.7	-65.29	0.0101	-0.66
7256	MLI Rec STR sx	-81.79	18.2	-63.59	0.0101	-0.64
7257	MLI Rec STR sx	-80.69	18.4	-62.29	0.0101	-0.63
7258	MLI Rec STR sx	-79.43	19.1	-60.33	0.0101	-0.61
7259	MLI Rec STR sx	-77.9	20	-57.9	0.0101	-0.58
7260	MLI Rec STR sx	-74.55	21.3	-53.25	0.0101	-0.54
	Average					
	Total	-65.35			11.6779	-443
	<b>Weighted on Areas</b>					<b>-38</b>

Table 7.1-2 HERSCHEL - REQ ITP-100-H

**ITP-120-H**

CVV truss attachment points  $T < 293 \text{ K}$  ( $20^\circ\text{C}$ ) for the hottest pitch in the range  $[-30^\circ, 0^\circ]$  and for the hottest dissipation case: EOL in Winter pitch  $0^\circ$  and Telecom MODE1

<b>HERSCHEL ITP-120-H</b>				
<b>WORST CASE: EOL Rotx=-1 Roty=0 Wnter Telecom MODE1</b>				
<b>NODE</b>	<b>LABEL</b>	<b>T</b>	<b>UFP</b>	<b>T+UFP</b>
		<b>[°C]</b>	<b>[°C]</b>	<b>[°C]</b>
2701	I/F CVV	22.86	7.0	29.86
2702	I/F CVV	20.55	7.2	27.75
2703	I/F CVV	16.87	7.4	24.27
2704	I/F CVV	16.08	7.4	23.48
2705	I/F CVV	11.93	7.6	19.53
2706	I/F CVV	11.81	7.6	19.41
2707	I/F CVV	10.58	7.5	18.08
2708	I/F CVV	10.63	7.5	18.13
2709	I/F CVV	15.4	7.5	22.90
2710	I/F CVV	16.15	7.5	23.65
2711	I/F CVV	19.3	7.5	26.80
2712	I/F CVV	22.38	7.1	29.48
	<b>Average</b>	<b>16.2</b>		<b>23.6</b>

Table 7.1-3 HERSCHEL - REQ ITP-120-H

**ITP-130-H**

SVM shield attachment points  $T < 293 \text{ K}$  ( $20^\circ\text{C}$ ) for the hottest pitch in the range  $[-30^\circ, 0^\circ]$  and for the hottest dissipation case: EOL in Winter pitch  $0^\circ$  and Telecom MODE1

<b>HERSCHEL ITP-130-H</b>				
<b>WORST CASE: EOL Rotx=-1 Roty=0 Wnter Telecom MODE1</b>				
<b>NODE</b>	<b>LABEL</b>	<b>T</b>	<b>UFP</b>	<b>T+UFP</b>
		<b>[°C]</b>	<b>[°C]</b>	<b>[°C]</b>
2718	I/F R1 SVM SHIELD +Y	17.78	7.4	25.18
2719	I/F T1 SVM SHIELD +Y	15.46	7.5	22.96
2720	I/F T2 SVM SHIELD +Y	12.7	7.5	20.20
2721	I/F T3 SVM SHIELD -Z	12.93	7.7	20.63
2722	I/F T4 SVM SHIELD -Z	11.63	7.5	19.13
2723	I/F T5 SVM SHIELD -Y	13.28	7.2	20.48
2724	I/F T6 SVM SHIELD -Y	17.04	7.3	24.34
2725	I/F R2 SVM SHIELD -Y	19.28	7.5	26.78
2726	I/F SS1 SVM SHIELD +Y	15.72	7.4	23.12
2727	I/F SS2 SVM SHIELD +Y-Z	11.57	7.6	19.17
2728	I/F SS3 SVM SHIELD -Y-Z	10.28	7.5	17.78
2729	I/F SS4 SVM SHIELD -Y	15.05	7.5	22.55
2730	I/F SS5 SVM SHIELD -Z	10.23	7.5	17.73
2731	I/F SS6 SVM SHIELD -Z	11.46	7.6	19.06
	<b>Average</b>	<b>13.9</b>		<b>21.4</b>

Table 7.1-4 HERSCHEL - REQ ITP-130-H

**ITP-135-H**

Thermal conductive leak from the STR assembly to the HPLM for all the Sizing Cases defined in AD9 &lt; 150mW

HERSCHEL ITP-135-H						
Case	Prop.	Description	SEASON	POWER	Analysis type	Flux to CVV [mW]
A	EOL	RotX=+1, RotY=-30	Winter	TelecomE/mode 1	Transient	0.103
B	EOL	RotX=+1, RotY=-30	Winter	TelecomE/mode 2 photometry	Transient	0.104
C	EOL	RotX=+1, RotY=-30	Winter	TelecomE/mode 2 spectroscopy	Transient	0.104
D	EOL	RotX=-1, RotY=-30	Winter	TelecomE/mode 1	Transient	0.103
E	EOL	RotX=-1, RotY=-30	Winter	TelecomE/mode 2 photometry	Transient	0.103
F	EOL	RotX=-1, RotY=-30	Winter	TelecomE/mode 2 spectroscopy	Transient	0.103
G	BOL	RotX=-1, RotY=+30	Summer	Scientific/mode 3	Transient	0.098
H	BOL	RotX=-1, RotY=+30	Summer	Scientific/mode 1	Transient	0.098
I	BOL	RotX=+5, RotY=0	Summer	Survival	Transient	0.086

Table 7.1-5 HERSCHEL REQ ITP-135-H



**ITI-020-H**

Preliminary verification and concept validation have been performed by AAS-I. Final verification, applicable to all the involved units, is still to be performed pending confirmation of stability requirements and I/F point control verification. AAS-I is waiting CR related these points (see H-P-ASP-MN-7404, dated 8/2/06). Based on this last step, all the necessary modifications (HW and SW) will be then imposed to the applicable suppliers.

<b>ITI-020-H COLD CASE P</b>				
<b>Node number</b>	<b>Unit name</b>	<b>Max [K/s]</b>	<b>Req. [K/s]</b>	<b>Compl/Not-Compl</b>
404	HSDCU	-	0.000833333	-
405	HSDPU	-	0.000833333	-
406	HSFCU	-	0.000833333	-
501	FHWOV	-	0.0003	-
502	FHHRV	-	0.0003	-
503	FHICU	-	0.0014	-
504	FHFCU	-	0.0014	-
506	FHWEV	-	0.0003	-
507	FHIFV	-	0.0003	-
508	FHWIH IFV-HRV	-	0.0014	-
509	FHWIH IFV-WEV	-	0.0014	-
510	FHWIH WEV-WOV	-	0.0014	-
511	FHWIH HRV-HRH	-	0.0014	-
601	FHWOH	-	0.0003	-
602	FHWEH	-	0.0003	-
603	FHHRH	-	0.0003	-
604	FHLCU	-	0.0003	-
605	FHLSU	-	0.0003	-
606	FHIFH	-	0.0003	-
607	FHWIH IFH-HRH	-	0.0014	-
608	FHWIH IFH-WEH	-	0.0014	-
609	FHWIH WEH-WHO	-	0.0014	-

Table 7.1-6 HERSCHEL stability requirement (Cold case)

ITI-020-H		HOT CASE Q		
Node number	Unit name	Max [K/s]	Req. [K/s]	Compl/Not-Compl
404	HSDCU	-	0.000833333	-
405	HSDPU	-	0.000833333	-
406	HSFCU	-	0.000833333	-
501	FHWOV	-	0.0003	-
502	FHHRV	-	0.0003	-
503	FHICU	-	0.0014	-
504	FHFCU	-	0.0014	-
506	FHWEV	-	0.0003	-
507	FHIFV	-	0.0003	-
508	FHWIH IFV-HRV	-	0.0014	-
509	FHWIH IFV-WEV	-	0.0014	-
510	FHWIH WEV-WOV	-	0.0014	-
511	FHWIH HRV-HRH	-	0.0014	-
601	FHWOH	-	0.0003	-
602	FHWEH	-	0.0003	-
603	FHHRH	-	0.0003	-
604	FHLCU	-	0.0003	-
605	FHLSU	-	0.0003	-
606	FHIFH	-	0.0003	-
607	FHWIH IFH-HRH	-	0.0014	-
608	FHWIH IFH-WEH	-	0.0014	-
609	FHWIH WEH-WHO	-	0.0014	-

Table 7.1-7 HERSCHEL stability requirement (Hot case)

**ACP-060-H**

Maximum rate of temperature variation not exceeding 0.25 °C/100 sec at STR mounting plate I/F:

<b>COLD CASE P</b>				
<b>Node number</b>	<b>Unit name</b>	<b>Max <math>\Delta T/\Delta t</math> [K/s]</b>	<b>Req. [K/s]</b>	<b>Compl/Not-Compl</b>
20014	STR Mounting plate I/F	0.001115	0.0025	Compl
20015	STR Mounting plate I/F	0.001151	0.0025	Compl
20022	STR Mounting plate I/F	0.001079	0.0025	Compl
20023	STR Mounting plate I/F	0.00109	0.0025	Compl
80027	STR Foot	0.000289	0.0025	Compl
80028	STR Foot	0.000261	0.0025	Compl
80029	STR Foot	0.00028	0.0025	Compl
80030	STR Foot	0.000263	0.0025	Compl

Table 7.1-8 HERSCHEL STR stability requirement (Cold case)

<b>HOT CASE Q</b>				
<b>Node number</b>	<b>Unit name</b>	<b>Max <math>\Delta T/\Delta t</math> [K/s]</b>	<b>Req. [K/s]</b>	<b>Compl/Not-Compl</b>
20014	STR Mounting plate I/F	0.001136	0.0025	Compl
20015	STR Mounting plate I/F	0.001171	0.0025	Compl
20022	STR Mounting plate I/F	0.001107	0.0025	Compl
20023	STR Mounting plate I/F	0.001116	0.0025	Compl
80027	STR Foot	0.000286	0.0025	Compl
80028	STR Foot	0.000269	0.0025	Compl
80029	STR Foot	0.000298	0.0025	Compl
80030	STR Foot	0.000262	0.0025	Compl

Table 7.1-9 HERSCHEL STR stability requirement (Hot case)

**ACP-060-H**

Amplitude of temperature variation within 0.5 °C around any setpoint of STR

UNIT	Max variation during transient[°C]	Req. [°C]	Compl/Not-Compl
STR feet	80027 = (*) 80028 = (*) 80029 = (*) 80030 = (*)	0.5	-

Table 7.1-10 HERSCHEL STR stability requirement (Cold Case)

UNIT	Max variation during transient[°C]	Req. [°C]	Compl/Not-Compl
STR feet	80027 = (*) 80028 = (*) 80029 = (*) 80030 = (*)	0.5	-

Table 7.1-11 HERSCHEL STR stability requirement (Hot Case)

(\*) Updated thermal analysis results have been submitted to OFFICINE GALILEO for evaluation of the STRs performances.

**ACP-060-H**

The maximum temperature gradient generated by STR at baseplate between mounting feet  $\leq 0.4$  °C

UNIT	Temp. gradient between the mounting feet [°C]	Req. [°C]	Compl/Not-Compl
STR mount. Feet	See Fig 4.1-1	0.4	Part. Compl.

Table 7.1-12a HERSCHEL STR stability requirement (Cold Case)

UNIT	Temp. gradient between the mounting feet [°C]	Req. [°C]	Compl/Not-Compl
STR mount. Feet	See Fig 4.1-2	0.4	Part. Compl.

Table 7.1-12b HERSCHEL STR stability requirement (Hot Case)

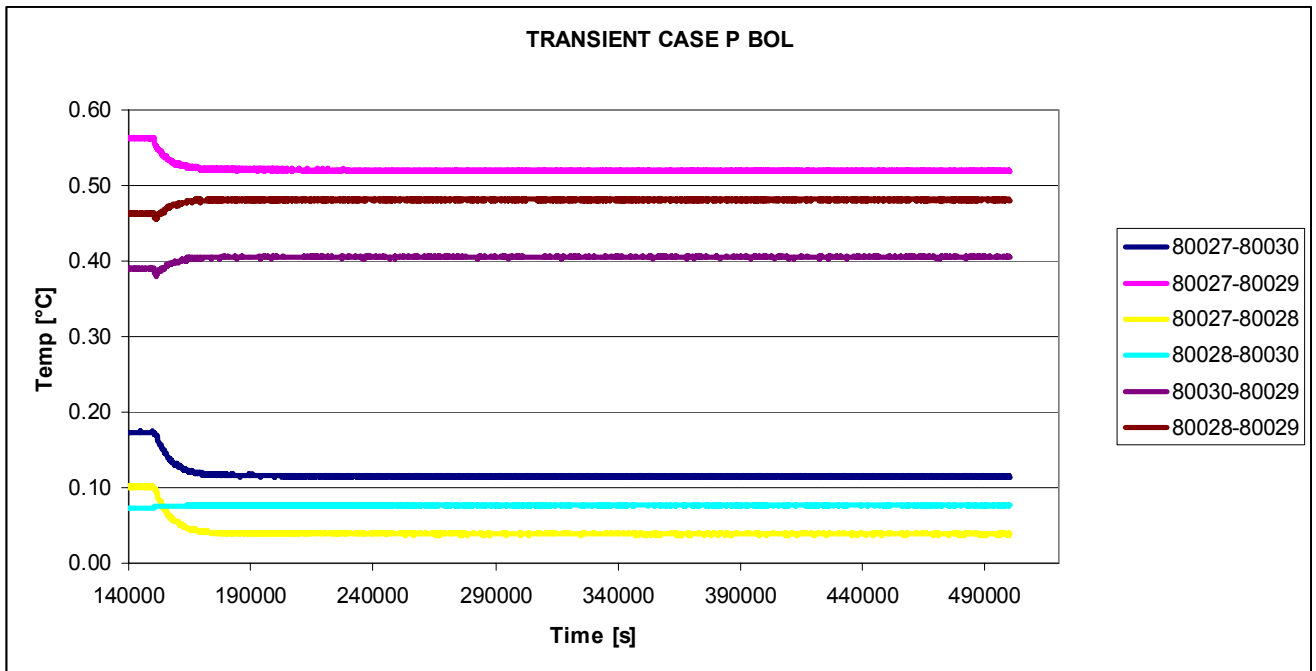

Figure 7.1-1 HERSCHEL STR feet temperature gradient (COLD CASE P)

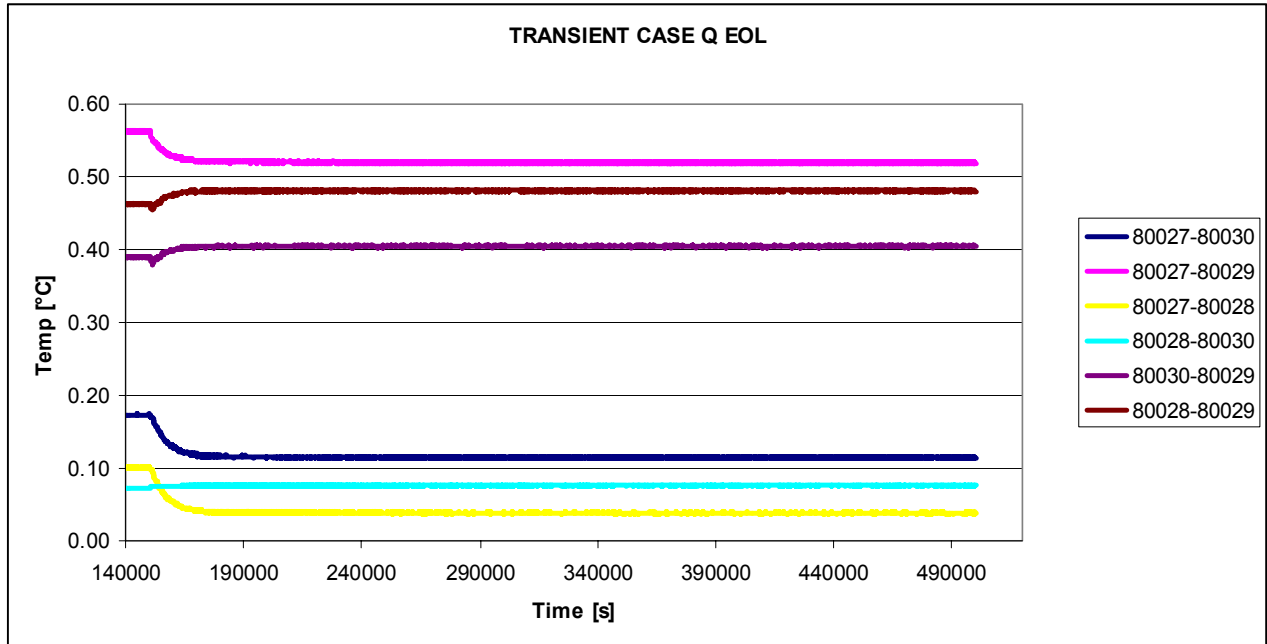

Figure 7.1-2 HERSCHEL STR feet temperature gradient (HOT CASE Q)

**THP-095-H**

The requirement relevant to the maximum variation of the gradient of the I/F points, has been evaluated during a change of attitude both in COLD and HOT case comparing couples of I/F points covering all the combinations.

Intf. point #1	Intf. point #2	COLD CASE P	HOT CASE Q
		Max gradient variation [°C]	Max gradient variation [°C]
2701	2702	2.149	2.103
2701	2703	3.268	3.608
2701	2704	3.407	3.771
2701	2705	3.134	3.442
2701	2706	3.207	3.527
2701	2707	2.205	2.701
2701	2708	2.005	2.501
2701	2709	2.025	2.182
2701	2710	2.077	2.217
2701	2711	1.151	1.017
2701	2712	0.361	0.353
2702	2703	2.567	4.297
2702	2704	3.281	4.509
2702	2705	3.933	4.352
2702	2706	4.017	4.44
2702	2707	4.096	4.613
2702	2708	3.911	4.404
2702	2709	2.948	4.008
2702	2710	2.802	3.446
2702	2711	3.157	2.088
2702	2712	2.508	2.432
2703	2704	0.264	0.294
2703	2705	1.627	1.697
2703	2706	1.699	1.701
2703	2707	2.708	2.897
2703	2708	2.732	2.94
2703	2709	1.384	2.699
2703	2710	1.181	2.678
2703	2711	2.91	3.261
2703	2712	3.439	3.79
2704	2705	1.571	1.631
2704	2706	1.567	1.623
2704	2707	2.651	2.851
2704	2708	2.675	2.913
2704	2709	1.439	2.699

Intf. point #1	Intf. point #2	COLD CASE P	HOT CASE Q
		Max gradient variation [°C]	Max gradient variation [°C]
2704	2710	1.621	2.679
2704	2711	2.926	3.312
2704	2712	3.521	3.9
2705	2706	0.105	0.089
2705	2707	1.28	1.452
2705	2708	1.374	1.539
2705	2709	1.465	1.733
2705	2710	1.474	1.766
2705	2711	2.154	2.55
2705	2712	3.141	3.472
2706	2707	1.288	1.451
2706	2708	1.405	1.569
2706	2709	1.442	1.696
2706	2710	1.445	1.723
2706	2711	2.208	2.617
2706	2712	3.209	3.552
2707	2708	0.216	0.247
2707	2709	0.573	0.59
2707	2710	0.558	0.608
2707	2711	1.099	1.705
2707	2712	2.175	2.409
2708	2709	0.42	0.44
2708	2710	0.447	0.49
2708	2711	0.914	1.515
2708	2712	1.978	2.192
2709	2710	0.072	0.068
2709	2711	0.921	1.17
2709	2712	1.99	2.166
2710	2711	0.966	1.202
2710	2712	2.038	2.198
2711	2712	2.038	2.198

Table 7.1-13 HERSCHEL temperature gradient of SVM/PLM I/F points



## 7.2 Planck requirements

The PLANCK SVM interface requirements are listed below:

REQUIR.	DESCRIPTION	RESULT	STATUS (*)
ITP-140-P	MLI blankets with high efficiency installed on the top of SVM upper panels.	Node 7001-7008 : $\epsilon=0.05$ ; 20 layers	C
ITP-150-P	Specific characteristic of the subplatform MLI blankets Ext layer temperature <220K (< -53.15 °C)	Nodes 7201-7238 $\alpha=0.15 / \epsilon=0.05$ Avg Max temperature -40.8°C (Table 4.2-2)	NC
ITP-170-P	Radiative load from BEU-PAU $\leq 2.3W$	Max heat flux = 2.45W (Table 4.2-6)	NC
ITP-180-P	Specific characteristic of BEU/PAU MLI blankets Ext layer temperature <235K (< -38.15 °C)	Nodes 7521-7522 $\alpha=0.15 / \epsilon=0.05$ Max temperature -28.4°C (Table 4.2-3)	NC
ITP-190-P	Back side of Solar Array must be covered with MLI	MLI nodes 8101-8104	C
ITP-200-P	Specific characteristic of the MLI blankets on the back side of the Solar Array Ext layer temperature <300K (< 26.85 °C)	Nodes 8101-8104 $\alpha=0.15 / \epsilon=0.05$ Max temperature 39.9°C (Table 4.2-4)	NC
ITP-210-P	The temperature of P-PLM truss attachment points < 310K (<36.85 °C)	Nodes 10021-10026 Max temperature 29.9°C (Table 4.2-5)	C
ITP-220-P	Temperature stability at I/F truss point $\leq 0.02K$	Nodes 10021 – 10026 Results in Table 4.2-7	C
ITP-230-P	Temperature stability at radiative panels level $\leq 0.01K Hz^{1/2}$	Results in Table 4.2.8	C
ITI-030-P	Keep HFI and LFI instruments in their design range and under maximum temperature stability requirements. PAU: <ul style="list-style-type: none"> <li>• Requirement: <math>\pm 3 K/hour</math></li> <li>• Goal : <math>\pm 1.1 K/hour</math></li> </ul> BEU, DAE: <ul style="list-style-type: none"> <li>• Requirement: <math>\pm 3 K/hour</math></li> <li>• Goal : <math>\pm 0.2 K/hour</math></li> </ul>	See temperature results of HFI and LFI units Stability requirement in table 4.2-9	C
ITI-040-P	SCC: <ul style="list-style-type: none"> <li>- use a very emissive coating for radiative panels</li> <li>- decouple SCC panels</li> <li>- make use of a heat pipe network</li> </ul>	<ul style="list-style-type: none"> <li>- panels with <math>\epsilon=0.87</math></li> <li>- titanium cleats between SCC panel and contiguous parts</li> <li>- heat pipe network AD8</li> </ul>	C
ITP-070-P	SVM compatible with PPLM as described in AD19	Model taken from doc. AD19	C
ITP-080_P	SVM compatible with negative load of 5W distributed over 6 nodes	Negative load flux applied onto nodes 10021-10026	C
ITI-010-P	SVM compatible with negative heat flow on BEU through wave guides (15W cold case / 0W hot case)	Applied on power dissipation value	C

SCC Stability	Bed fluctuation: ± 3K for first adjacent element ± 1K for the next adjacent element ± 0.5 for next most element	Results in tables 4.2-10	NC
TANK stability	The gradient between each tank shall be less than 0.1 over one hour, 0.25 °C over one day and 1.5 °C over life	Results in Table 4.2.11	PC

(\*) C=Compliance; NC= Not Compliance; PC= Partially Compliance

Table 7.2-1 PLANCK – SVM I/F requirements

PLANCK ITP-150-P						
WORST HOT CASE: EOL Rotx=-10						
NODE	LABEL	Temperature [°C]	UFP [°C]	T+UFP [°C]	Area [m²]	T+UFP * Area
7201	MLI SVM Top Disc +Y+Z	-60.49	24.7	-35.79	0.041	-1.467
7202	MLI SVM Top Disc +Y+Z	-62.02	24.7	-37.32	0.0481	-1.795
7203	MLI SVM Top Disc +Y+Z	-62.40	24.5	-37.90	0.0475	-1.800
7204	MLI SVM Top Disc +Y+Z	-63.75	24.9	-38.85	0.0805	-3.127
7205	MLI SVM Top Disc +Y+Z	-64.11	24.8	-39.31	0.0385	-1.513
7206	MLI SVM Top Disc +Y+Z	-64.66	24.8	-39.86	0.0414	-1.650
7207	MLI SVM Top Disc +Y+Z	-65.37	24.7	-40.67	0.0387	-1.574
7208	MLI SVM Top Disc +Y+Z	-65.92	24.7	-41.22	0.0304	-1.253
7209	MLI SVM Top Disc +Y+Z	-65.84	24.4	-41.44	0.0282	-1.169
7210	MLI SVM Top Disc +Y+Z	-65.69	24.5	-41.19	0.0255	-1.050
7211	MLI SVM Top Disc +Y+Z	-64.88	24.3	-40.58	0.0374	-1.518
7212	MLI SVM Top Disc +Y+Z	-64.03	24.3	-39.73	0.0312	-1.240
7213	MLI SVM Top Disc +Y+Z	-64.42	24.5	-39.92	0.029	-1.158
7214	MLI SVM Top Disc +Y+Z	-63.01	24	-39.01	0.0505	-1.970
7215	MLI SVM Top Disc +Y+Z	-63.67	24.1	-39.57	0.0514	-2.034
7216	MLI SVM Top Disc +Y+Z	-51.93	16.3	-35.63	0.0578	-2.059
7217	MLI SVM Top Disc +Y+Z	-54.88	18.3	-36.58	0.0968	-3.541
7218	MLI SVM Top Disc +Y+Z	-43.63	24 (**)	-19.63	0.0488	-0.958
7219	MLI SVM Top Disc +Y+Z	-37.54	24 (**)	-13.54	0.0573	-0.776
7220	MLI SVM Top Disc +Y+Z	-43.08	24 (**)	-19.08	0.0488	-0.931
7221	MLI SVM Top Disc +Y+Z	-37.76	24 (**)	-13.76	0.0573	-0.788
7222	MLI SVM Top Disc +Y+Z	-50.19	15.7	-34.49	0.0578	-1.994
7223	MLI SVM Top Disc +Y+Z	-51.32	17.5	-33.82	0.0968	-3.274
7224	MLI SVM Top Disc +Y+Z	-52.44	21.1	-31.34	0.0505	-1.583
7225	MLI SVM Top Disc +Y+Z	-45.67	20.6	-25.07	0.0514	-1.289
7226	MLI SVM Top Disc +Y+Z	-51.59	21.8	-29.79	0.031	-0.923
7227	MLI SVM Top Disc +Y+Z	-44.34	18.2	-26.14	0.0374	-0.978
7228	MLI SVM Top Disc +Y+Z	-63.35	24.2	-39.15	0.0334	-1.308
7229	MLI SVM Top Disc +Y+Z	-56.80	20.4	-36.40	0.0541	-1.969
7230	MLI SVM Top Disc +Y+Z	-63.36	23.7	-39.66	0.044	-1.745
7231	MLI SVM Top Disc +Y+Z	-64.11	23.9	-40.21	0.0282	-1.134
7232	MLI SVM Top Disc +Y+Z	-65.24	24.8	-40.44	0.0304	-1.229

PLANCK ITP-150-P						
WORST HOT CASE: EOL Rotx=-10						
NODE	LABEL	Temperature [°C]	UFP [°C]	T+UFP [°C]	Area [m <sup>2</sup> ]	T+UFP * Area
7233	MLI SVM Top Disc +Y+Z	-65.11	24.5	-40.61	0.0387	-1.572
7234	MLI SVM Top Disc +Y+Z	-63.62	24.6	-39.02	0.0385	-1.502
7235	MLI SVM Top Disc +Y+Z	-64.66	24.7	-39.96	0.0414	-1.654
7236	MLI SVM Top Disc +Y+Z	-61.76	24.8	-36.96	0.0475	-1.756
7237	MLI SVM Top Disc +Y+Z	-63.95	24.7	-39.25	0.0805	-3.160
7238	MLI SVM Top Disc +Y+Z	-60.32	24.9	-35.42	0.041	-1.452
7239	MLI SVM Top Disc +Y+Z	-61.97	25.3	-36.67	0.0481	-1.764
7245	SVM Top Disc MLI	-70.09	22.9	-47.19	1.7492	-82.545
		<b>AVG T</b>		<b>AVG T+UFP</b>	<b>Σ Area</b>	<b>Σ T+UFP*Area</b>
		-58.72		-35.55	3.586	-146.2
	<b>Weighed avg T: °C</b>	<b>-63.59</b>		<b>Weighed avg T+UFP: °C</b>		<b>-40.77</b>

(\*\*) values assumed

Table 7.2-2 PLANCK – ITP-150-P Temperature Results

PLANCK ITP-180-P				
WORST HOT CASE: EOL Rotx=-10				
NODE	LABEL	T [°C]	UFP [°C]	T+UFP [°C]
7521	MLI on BEU	<b>-58.9</b>	24.0	-34.9
7522	MLI on PAU	<b>-51.7</b>	23.3	-28.4
	<b>Max temperature</b>	<b>-51.7</b>		<b>-28.4</b>

Table 7.2-3 PLANCK – ITP-180-P Temperature Results

Note: 24°C of UFP on BEU MLI is assumed.

PLANCK ITP-200-P				
WORST HOT CASE: EOL Rotx=-10				
NODE	LABEL	T [°C]	UFP [°C]	T+UFP [°C]
8101	MLI Solar Array vs. sate	<b>11.0</b>	27.7	38.7
8102	MLI Solar Array vs. sate	<b>13.0</b>	26.9	39.9
8103	MLI Solar Array vs. sate	<b>12.3</b>	27.2	39.5
8104	MLI Solar Array vs. sate	<b>11.0</b>	27.3	38.3
	<b>Max temperature</b>	<b>13.0</b>		<b>39.9</b>

Table 7.2-4 PLANCK – ITP-200-P Temperature Results

PLANCK ITP-210-P				
WORST HOT CASE: EOL Rotx=-10				
NODE	LABEL	T [°C]	UFP [°C]	T+UFP [°C]
10021	I/F PLM/SVM strut1	20.1	7.9	28.0
10022	I/F PLM/SVM strut2	18.7	7.9	26.6
10023	I/F PLM/SVM strut3	21.1	8.8	29.9
10024	I/F PLM/SVM strut4	19.7	8.8	28.5
10025	I/F PLM/SVM strut5	18.7	7.9	26.6
10026	I/F PLM/SVM strut6	20.0	7.9	27.9
	<b>Max temperature</b>	<b>21.1</b>		<b>29.9</b>

Table 7.2-5 PLANCK – ITP-210-P Temperature Results

PLANCK ITP-170-P – Temperature considered without uncertainty							
NODES	GR [W/K <sup>4</sup> ]	A1	A2	A3	B1	B2	C
		Heat Flow [ W ]	Heat Flow [ W ]	Heat Flow [ W ]	Heat Flow [ W ]	Heat Flow [ W ]	Heat Flow [ W ]
GR(D561,B10001)	7.99E-05	1.762E-02	1.463E-02	1.669E-02	2.089E-02	2.088E-02	1.238E-02
GR(D561,B10004)	1.45E-04	3.444E-02	2.899E-02	3.274E-02	4.039E-02	4.036E-02	2.491E-02
GR(D561,B10010)	1.38E-05	2.717E-03	2.200E-03	2.556E-03	3.281E-03	3.279E-03	1.814E-03
GR(D561,B10011)	4.31E-05	9.637E-03	8.020E-03	9.134E-03	1.140E-02	1.140E-02	6.810E-03
GR(D562,B10001)	8.65E-05	2.376E-02	1.940E-02	2.240E-02	2.819E-02	2.818E-02	1.627E-02
GR(D562,B10004)	1.44E-04	4.193E-02	3.466E-02	3.966E-02	4.931E-02	4.928E-02	2.946E-02
GR(D562,B10010)	1.55E-05	3.892E-03	3.111E-03	3.649E-03	4.687E-03	4.684E-03	2.552E-03
GR(D562,B10011)	2.96E-05	8.221E-03	6.728E-03	7.755E-03	9.740E-03	9.734E-03	5.658E-03
GR(D563,B10001)	8.35E-05	2.292E-02	1.872E-02	2.159E-02	2.719E-02	2.718E-02	1.570E-02
GR(D563,B10004)	1.42E-04	4.125E-02	3.411E-02	3.900E-02	4.850E-02	4.848E-02	2.898E-02
GR(D563,B10010)	2.64E-05	6.629E-03	5.301E-03	6.210E-03	7.980E-03	7.976E-03	4.345E-03
GR(D563,B10011)	1.53E-05	4.235E-03	3.467E-03	3.993E-03	5.017E-03	5.015E-03	2.915E-03
GR(D564,B10001)	7.98E-05	1.755E-02	1.464E-02	1.651E-02	2.080E-02	2.079E-02	1.234E-02
GR(D564,B10004)	1.47E-04	3.462E-02	2.928E-02	3.272E-02	4.059E-02	4.057E-02	2.505E-02
GR(D564,B10010)	3.87E-05	7.604E-03	6.195E-03	7.101E-03	9.181E-03	9.175E-03	5.077E-03
GR(D564,B10011)	1.43E-05	3.192E-03	2.670E-03	3.005E-03	3.775E-03	3.773E-03	2.256E-03
GR(D566,B10001)	1.21E-04	2.631E-02	2.186E-02	2.493E-02	3.120E-02	3.118E-02	1.852E-02
GR(D566,B10004)	1.95E-04	4.580E-02	3.859E-02	4.356E-02	5.372E-02	5.369E-02	3.317E-02
GR(D566,B10010)	1.79E-05	3.482E-03	2.821E-03	3.276E-03	4.206E-03	4.203E-03	2.325E-03
GR(D566,B10011)	7.29E-05	1.610E-02	1.341E-02	1.526E-02	1.905E-02	1.904E-02	1.139E-02
GR(D567,B10001)	1.31E-04	3.221E-02	2.652E-02	3.042E-02	3.812E-02	3.811E-02	2.237E-02
GR(D567,B10004)	1.92E-04	5.026E-02	4.194E-02	4.765E-02	5.891E-02	5.888E-02	3.585E-02

PLANCK ITP-170-P – Temperature considered without uncertainty							
NODES	GR [W/K <sup>4</sup> ]	A1	A2	A3	B1	B2	C
		Heat Flow [ W ]	Heat Flow [ W ]	Heat Flow [ W ]	Heat Flow [ W ]	Heat Flow [ W ]	Heat Flow [ W ]
GR(D567,B10010)	2.27E-05	5.025E-03	4.044E-03	4.717E-03	6.045E-03	6.042E-03	3.327E-03
GR(D567,B10011)	3.68E-05	9.119E-03	7.527E-03	8.619E-03	1.077E-02	1.077E-02	6.363E-03
GR(D568,B10001)	1.29E-04	3.158E-02	2.603E-02	2.978E-02	3.738E-02	3.735E-02	2.193E-02
GR(D568,B10004)	1.95E-04	5.088E-02	4.251E-02	4.816E-02	5.964E-02	5.961E-02	3.630E-02
GR(D568,B10010)	2.98E-05	6.610E-03	5.327E-03	6.193E-03	7.953E-03	7.947E-03	4.376E-03
GR(D568,B10011)	2.36E-05	5.837E-03	4.823E-03	5.507E-03	6.896E-03	6.892E-03	4.073E-03
GR(D569,B10001)	1.23E-04	2.674E-02	2.234E-02	2.516E-02	3.171E-02	3.169E-02	1.883E-02
GR(D569,B10004)	1.94E-04	4.528E-02	3.835E-02	4.279E-02	5.310E-02	5.307E-02	3.282E-02
GR(D569,B10010)	6.06E-05	1.175E-02	9.584E-03	1.097E-02	1.420E-02	1.419E-02	7.855E-03
GR(D569,B10011)	1.70E-05	3.733E-03	3.126E-03	3.515E-03	4.418E-03	4.415E-03	2.643E-03
GR(D571,B10001)	1.48E-04	3.185E-02	2.648E-02	3.018E-02	3.776E-02	3.775E-02	2.244E-02
GR(D571,B10004)	1.80E-04	4.175E-02	3.521E-02	3.971E-02	4.895E-02	4.893E-02	3.028E-02
GR(D571,B10010)	1.99E-05	3.820E-03	3.097E-03	3.595E-03	4.616E-03	4.613E-03	2.553E-03
GR(D571,B10011)	1.05E-04	2.293E-02	1.912E-02	2.174E-02	2.713E-02	2.712E-02	1.624E-02
GR(D572,B10001)	1.56E-04	3.602E-02	2.979E-02	3.406E-02	4.259E-02	4.257E-02	2.518E-02
GR(D572,B10004)	1.78E-04	4.409E-02	3.697E-02	4.184E-02	5.160E-02	5.157E-02	3.169E-02
GR(D572,B10010)	2.61E-05	5.408E-03	4.366E-03	5.079E-03	6.506E-03	6.502E-03	3.596E-03
GR(D572,B10011)	3.75E-05	8.754E-03	7.258E-03	8.282E-03	1.033E-02	1.033E-02	6.151E-03
GR(D573,B10001)	1.54E-04	3.538E-02	2.931E-02	3.338E-02	4.184E-02	4.181E-02	2.474E-02
GR(D573,B10004)	1.78E-04	4.394E-02	3.690E-02	4.161E-02	5.142E-02	5.139E-02	3.159E-02
GR(D573,B10010)	2.78E-05	5.765E-03	4.664E-03	5.401E-03	6.936E-03	6.931E-03	3.834E-03
GR(D573,B10011)	2.39E-05	5.567E-03	4.623E-03	5.255E-03	6.570E-03	6.566E-03	3.912E-03
GR(D574,B10001)	1.47E-04	3.155E-02	2.638E-02	2.969E-02	3.741E-02	3.739E-02	2.225E-02
GR(D574,B10004)	1.86E-04	4.279E-02	3.627E-02	4.043E-02	5.016E-02	5.014E-02	3.107E-02
GR(D574,B10010)	8.06E-05	1.537E-02	1.254E-02	1.435E-02	1.857E-02	1.856E-02	1.028E-02
GR(D574,B10011)	1.70E-05	3.699E-03	3.101E-03	3.483E-03	4.376E-03	4.374E-03	2.623E-03
GR(D581,B10001)	3.31E-05	9.497E-03	8.940E-03	7.532E-03	1.065E-02	1.064E-02	6.422E-03
GR(D581,B10004)	7.50E-05	2.272E-02	2.146E-02	1.827E-02	2.533E-02	2.532E-02	1.576E-02
GR(D581,B10005)	6.44E-06	1.932E-03	1.824E-03	1.550E-03	2.156E-03	2.155E-03	1.334E-03
GR(D581,B10010)	8.62E-05	2.269E-02	2.124E-02	1.757E-02	2.568E-02	2.567E-02	1.469E-02
GR(D582,B10001)	3.25E-05	9.247E-03	8.706E-03	7.338E-03	1.036E-02	1.036E-02	6.260E-03
GR(D582,B10004)	7.57E-05	2.278E-02	2.152E-02	1.834E-02	2.539E-02	2.538E-02	1.582E-02
GR(D582,B10005)	7.95E-06	2.369E-03	2.236E-03	1.902E-03	2.642E-03	2.641E-03	1.638E-03
GR(D582,B10010)	5.45E-05	1.423E-02	1.333E-02	1.103E-02	1.611E-02	1.610E-02	9.221E-03
GR(D583,B10001)	2.98E-05	8.303E-03	7.822E-03	6.609E-03	9.297E-03	9.293E-03	5.645E-03
GR(D583,B10004)	7.58E-05	2.236E-02	2.113E-02	1.805E-02	2.488E-02	2.487E-02	1.559E-02
GR(D583,B10005)	9.06E-06	2.643E-03	2.497E-03	2.128E-03	2.945E-03	2.943E-03	1.836E-03
GR(D583,B10010)	4.73E-05	1.207E-02	1.130E-02	9.377E-03	1.364E-02	1.364E-02	7.848E-03
GR(D584,B10001)	3.73E-05	8.650E-03	8.192E-03	7.015E-03	9.583E-03	9.580E-03	6.060E-03

PLANCK ITP-170-P – Temperature considered without uncertainty							
NODES	GR [W/K <sup>4</sup> ]	A1	A2	A3	B1	B2	C
		Heat Flow [ W ]	Heat Flow [ W ]	Heat Flow [ W ]	Heat Flow [ W ]	Heat Flow [ W ]	Heat Flow [ W ]
GR(D584,B10004)	7.18E-05	1.784E-02	1.696E-02	1.469E-02	1.964E-02	1.964E-02	1.285E-02
GR(D584,B10005)	6.91E-06	1.695E-03	1.610E-03	1.392E-03	1.868E-03	1.867E-03	1.215E-03
GR(D584,B10010)	9.69E-05	2.021E-02	1.902E-02	1.596E-02	2.263E-02	2.262E-02	1.348E-02
GR(D585,B10001)	3.69E-05	8.487E-03	8.039E-03	6.890E-03	9.401E-03	9.397E-03	5.955E-03
GR(D585,B10004)	7.43E-05	1.830E-02	1.740E-02	1.509E-02	2.014E-02	2.014E-02	1.320E-02
GR(D585,B10005)	9.21E-06	2.242E-03	2.130E-03	1.843E-03	2.470E-03	2.469E-03	1.610E-03
GR(D585,B10010)	6.07E-05	1.254E-02	1.180E-02	9.912E-03	1.404E-02	1.404E-02	8.374E-03
GR(D586,B10001)	3.64E-05	8.216E-03	7.787E-03	6.686E-03	9.092E-03	9.089E-03	5.785E-03
GR(D586,B10004)	7.34E-05	1.777E-02	1.690E-02	1.468E-02	1.954E-02	1.953E-02	1.287E-02
GR(D586,B10005)	9.45E-06	2.261E-03	2.149E-03	1.863E-03	2.488E-03	2.487E-03	1.629E-03
GR(D586,B10010)	4.53E-05	9.157E-03	8.623E-03	7.254E-03	1.025E-02	1.024E-02	6.133E-03
GR(D587,B10001)	4.82E-05	1.006E-02	9.552E-03	8.245E-03	1.108E-02	1.107E-02	7.169E-03
GR(D587,B10004)	6.65E-05	1.496E-02	1.426E-02	1.246E-02	1.637E-02	1.636E-02	1.098E-02
GR(D587,B10005)	6.39E-06	1.419E-03	1.352E-03	1.179E-03	1.554E-03	1.554E-03	1.036E-03
GR(D587,B10010)	1.05E-04	1.935E-02	1.826E-02	1.543E-02	2.157E-02	2.156E-02	1.309E-02
GR(D588,B10001)	4.67E-05	9.675E-03	9.191E-03	7.940E-03	1.065E-02	1.065E-02	6.907E-03
GR(D588,B10004)	6.74E-05	1.506E-02	1.437E-02	1.256E-02	1.648E-02	1.647E-02	1.107E-02
GR(D588,B10005)	7.87E-06	1.734E-03	1.652E-03	1.442E-03	1.899E-03	1.898E-03	1.268E-03
GR(D588,B10010)	6.22E-05	1.142E-02	1.078E-02	9.109E-03	1.272E-02	1.272E-02	7.735E-03
GR(D589,B10001)	4.49E-05	9.162E-03	8.708E-03	7.534E-03	1.008E-02	1.008E-02	6.559E-03
GR(D589,B10004)	7.00E-05	1.542E-02	1.471E-02	1.288E-02	1.686E-02	1.685E-02	1.137E-02
GR(D589,B10005)	1.01E-05	2.191E-03	2.089E-03	1.825E-03	2.397E-03	2.397E-03	1.606E-03
GR(D589,B10010)	4.40E-05	7.951E-03	7.506E-03	6.354E-03	8.855E-03	8.851E-03	5.399E-03
GR(D590,B10001)	2.04E-05	5.183E-03	4.897E-03	4.176E-03	5.774E-03	5.772E-03	3.588E-03
GR(D590,B10004)	9.94E-05	2.689E-02	2.549E-02	2.198E-02	2.977E-02	2.976E-02	1.911E-02
GR(D590,B10005)	5.84E-05	1.562E-02	1.480E-02	1.274E-02	1.731E-02	1.731E-02	1.105E-02
GR(D590,B10010)	1.01E-04	2.336E-02	2.194E-02	1.836E-02	2.630E-02	2.629E-02	1.544E-02
GR(D591,B10001)	1.78E-05	4.499E-03	4.250E-03	3.627E-03	5.011E-03	5.010E-03	3.117E-03
GR(D591,B10004)	9.39E-05	2.532E-02	2.401E-02	2.071E-02	2.803E-02	2.802E-02	1.801E-02
GR(D591,B10005)	7.27E-05	1.939E-02	1.838E-02	1.582E-02	2.149E-02	2.148E-02	1.373E-02
GR(D591,B10010)	1.49E-04	3.425E-02	3.217E-02	2.693E-02	3.855E-02	3.854E-02	2.266E-02
GR(D592,B10001)	2.47E-05	5.366E-03	5.091E-03	4.388E-03	5.925E-03	5.923E-03	3.806E-03
GR(D592,B10004)	9.49E-05	2.217E-02	2.112E-02	1.842E-02	2.432E-02	2.432E-02	1.618E-02
GR(D592,B10005)	5.95E-05	1.374E-02	1.307E-02	1.138E-02	1.509E-02	1.508E-02	9.975E-03
GR(D592,B10010)	1.03E-04	1.993E-02	1.878E-02	1.586E-02	2.225E-02	2.225E-02	1.343E-02
GR(D593,B10001)	1.91E-05	4.102E-03	3.894E-03	3.361E-03	4.528E-03	4.527E-03	2.918E-03
GR(D593,B10004)	9.20E-05	2.123E-02	2.023E-02	1.766E-02	2.328E-02	2.327E-02	1.553E-02
GR(D593,B10005)	7.19E-05	1.640E-02	1.561E-02	1.361E-02	1.800E-02	1.799E-02	1.194E-02
GR(D593,B10010)	1.38E-04	2.643E-02	2.492E-02	2.106E-02	2.950E-02	2.949E-02	1.786E-02
GR(D594,B10001)	3.29E-05	6.578E-03	6.254E-03	5.423E-03	7.231E-03	7.228E-03	4.728E-03

PLANCK ITP-170-P – Temperature considered without uncertainty							
NODES	GR [W/K <sup>4</sup> ]	A1	A2	A3	B1	B2	C
		Heat Flow [ W ]	Heat Flow [ W ]	Heat Flow [ W ]	Heat Flow [ W ]	Heat Flow [ W ]	Heat Flow [ W ]
GR(D594,B10004)	8.93E-05	1.928E-02	1.840E-02	1.615E-02	2.105E-02	2.104E-02	1.427E-02
GR(D594,B10005)	6.36E-05	1.354E-02	1.292E-02	1.131E-02	1.480E-02	1.479E-02	9.971E-03
GR(D594,B10010)	1.16E-04	2.045E-02	1.931E-02	1.638E-02	2.275E-02	2.274E-02	1.393E-02
GR(D595,B10001)	2.23E-05	4.404E-03	4.189E-03	3.637E-03	4.838E-03	4.837E-03	3.173E-03
GR(D595,B10004)	8.60E-05	1.838E-02	1.755E-02	1.542E-02	2.005E-02	2.004E-02	1.363E-02
GR(D595,B10005)	8.50E-05	1.791E-02	1.709E-02	1.499E-02	1.956E-02	1.956E-02	1.322E-02
GR(D595,B10010)	1.39E-04	2.408E-02	2.275E-02	1.932E-02	2.678E-02	2.677E-02	1.644E-02
GR(D595,B10011)	4.33E-06	8.658E-04	8.242E-04	7.170E-04	9.498E-04	9.497E-04	6.272E-04
<b>Total Heat Flux [ W ] :</b>		<b>1.836</b>	<b>1.620</b>	<b>1.627</b>	<b>2.109</b>	<b>2.108</b>	<b>1.291</b>

Table 7.2-6 PLANCK –ITP-170-P Flux Results

PLANCK ITP-170-P – Temperature considered with uncertainty							
NODES	GR [W/K <sup>4</sup> ]	A1	A2	A3	B1	B2	C
		Heat Flow [ W ]	Heat Flow [ W ]	Heat Flow [ W ]	Heat Flow [ W ]	Heat Flow [ W ]	Heat Flow [ W ]
GR(D561,B10001)	7.87E-05	2.068E-02	1.734E-02	1.964E-02	2.431E-02	2.430E-02	1.482E-02
GR(D561,B10004)	1.45E-04	4.000E-02	3.392E-02	3.811E-02	4.661E-02	4.658E-02	2.935E-02
GR(D561,B10010)	9.07E-06	3.245E-03	2.668E-03	3.065E-03	3.872E-03	3.869E-03	2.234E-03
GR(D561,B10011)	5.02E-05	1.129E-02	9.483E-03	1.073E-02	1.325E-02	1.324E-02	8.127E-03
GR(D562,B10001)	8.47E-05	2.755E-02	2.271E-02	2.604E-02	3.244E-02	3.243E-02	1.923E-02
GR(D562,B10004)	1.44E-04	4.823E-02	4.017E-02	4.572E-02	5.639E-02	5.636E-02	3.438E-02
GR(D562,B10010)	1.21E-05	4.571E-03	3.704E-03	4.301E-03	5.448E-03	5.445E-03	3.081E-03
GR(D562,B10011)	2.53E-05	9.518E-03	7.861E-03	9.002E-03	1.120E-02	1.119E-02	6.669E-03
GR(D563,B10001)	8.63E-05	2.657E-02	2.191E-02	2.510E-02	3.129E-02	3.128E-02	1.855E-02
GR(D563,B10004)	1.43E-04	4.745E-02	3.954E-02	4.496E-02	5.547E-02	5.544E-02	3.382E-02
GR(D563,B10010)	2.04E-05	7.784E-03	6.311E-03	7.321E-03	9.277E-03	9.273E-03	5.246E-03
GR(D563,B10011)	1.74E-05	4.904E-03	4.051E-03	4.635E-03	5.767E-03	5.765E-03	3.436E-03
GR(D564,B10001)	7.87E-05	2.060E-02	1.735E-02	1.944E-02	2.421E-02	2.420E-02	1.477E-02
GR(D564,B10004)	1.44E-04	4.022E-02	3.426E-02	3.810E-02	4.686E-02	4.683E-02	2.952E-02
GR(D564,B10010)	3.85E-05	9.083E-03	7.510E-03	8.522E-03	1.084E-02	1.083E-02	6.257E-03
GR(D564,B10011)	9.09E-06	3.739E-03	3.157E-03	3.531E-03	4.388E-03	4.385E-03	2.693E-03
GR(D566,B10001)	1.24E-04	3.090E-02	2.592E-02	2.935E-02	3.633E-02	3.631E-02	2.218E-02
GR(D566,B10004)	1.95E-04	5.323E-02	4.517E-02	5.072E-02	6.203E-02	6.199E-02	3.910E-02
GR(D566,B10010)	2.02E-05	4.161E-03	3.424E-03	3.932E-03	4.967E-03	4.964E-03	2.868E-03
GR(D566,B10011)	7.19E-05	1.887E-02	1.586E-02	1.793E-02	2.215E-02	2.213E-02	1.360E-02
GR(D567,B10001)	1.30E-04	3.754E-02	3.122E-02	3.556E-02	4.409E-02	4.407E-02	2.657E-02

PLANCK ITP-170-P – Temperature considered with uncertainty							
NODES	GR [W/K <sup>4</sup> ]	A1	A2	A3	B1	B2	C
		Heat Flow [ W ]	Heat Flow [ W ]	Heat Flow [ W ]	Heat Flow [ W ]	Heat Flow [ W ]	Heat Flow [ W ]
GR(D567,B10004)	1.99E-04	5.806E-02	4.880E-02	5.515E-02	6.764E-02	6.761E-02	4.201E-02
GR(D567,B10010)	2.51E-05	5.945E-03	4.853E-03	5.603E-03	7.075E-03	7.071E-03	4.052E-03
GR(D567,B10011)	3.94E-05	1.061E-02	8.841E-03	1.006E-02	1.244E-02	1.244E-02	7.541E-03
GR(D568,B10001)	1.32E-04	3.681E-02	3.064E-02	3.480E-02	4.323E-02	4.320E-02	2.605E-02
GR(D568,B10004)	1.91E-04	5.878E-02	4.946E-02	5.575E-02	6.848E-02	6.844E-02	4.253E-02
GR(D568,B10010)	3.27E-05	7.820E-03	6.393E-03	7.357E-03	9.307E-03	9.301E-03	5.331E-03
GR(D568,B10011)	1.69E-05	6.792E-03	5.665E-03	6.426E-03	7.965E-03	7.961E-03	4.827E-03
GR(D569,B10001)	1.16E-04	3.141E-02	2.649E-02	2.964E-02	3.693E-02	3.691E-02	2.256E-02
GR(D569,B10004)	1.93E-04	5.263E-02	4.488E-02	4.985E-02	6.132E-02	6.129E-02	3.869E-02
GR(D569,B10010)	5.71E-05	1.405E-02	1.163E-02	1.318E-02	1.677E-02	1.676E-02	9.691E-03
GR(D569,B10011)	1.36E-05	4.376E-03	3.699E-03	4.133E-03	5.137E-03	5.134E-03	3.156E-03
GR(D571,B10001)	1.44E-04	3.743E-02	3.143E-02	3.556E-02	4.400E-02	4.398E-02	2.690E-02
GR(D571,B10004)	1.81E-04	4.854E-02	4.124E-02	4.627E-02	5.655E-02	5.652E-02	3.571E-02
GR(D571,B10010)	1.47E-05	4.570E-03	3.763E-03	4.319E-03	5.455E-03	5.453E-03	3.153E-03
GR(D571,B10011)	9.34E-05	2.689E-02	2.263E-02	2.557E-02	3.156E-02	3.155E-02	1.941E-02
GR(D572,B10001)	1.54E-04	4.211E-02	3.517E-02	3.992E-02	4.939E-02	4.937E-02	3.001E-02
GR(D572,B10004)	1.75E-04	5.104E-02	4.311E-02	4.855E-02	5.937E-02	5.935E-02	3.722E-02
GR(D572,B10010)	2.42E-05	6.425E-03	5.265E-03	6.059E-03	7.642E-03	7.639E-03	4.403E-03
GR(D572,B10011)	3.70E-05	1.021E-02	8.549E-03	9.690E-03	1.196E-02	1.196E-02	7.311E-03
GR(D573,B10001)	1.60E-04	4.136E-02	3.460E-02	3.913E-02	4.852E-02	4.849E-02	2.949E-02
GR(D573,B10004)	1.81E-04	5.087E-02	4.303E-02	4.828E-02	5.917E-02	5.914E-02	3.710E-02
GR(D573,B10010)	3.62E-05	6.850E-03	5.624E-03	6.445E-03	8.149E-03	8.143E-03	4.695E-03
GR(D573,B10011)	2.23E-05	6.496E-03	5.445E-03	6.149E-03	7.609E-03	7.604E-03	4.650E-03
GR(D574,B10001)	1.46E-04	3.708E-02	3.131E-02	3.500E-02	4.359E-02	4.357E-02	2.667E-02
GR(D574,B10004)	1.85E-04	4.975E-02	4.248E-02	4.713E-02	5.796E-02	5.793E-02	3.664E-02
GR(D574,B10010)	8.01E-05	1.839E-02	1.523E-02	1.725E-02	2.195E-02	2.194E-02	1.270E-02
GR(D574,B10011)	1.50E-05	4.339E-03	3.671E-03	4.098E-03	5.092E-03	5.090E-03	3.135E-03
GR(D581,B10001)	3.16E-05	1.084E-02	1.023E-02	8.681E-03	1.210E-02	1.209E-02	7.458E-03
GR(D581,B10004)	7.57E-05	2.576E-02	2.438E-02	2.087E-02	2.861E-02	2.860E-02	1.810E-02
GR(D581,B10005)	6.25E-06	2.193E-03	2.074E-03	1.773E-03	2.438E-03	2.437E-03	1.536E-03
GR(D581,B10010)	7.28E-05	2.618E-02	2.459E-02	2.056E-02	2.946E-02	2.944E-02	1.738E-02
GR(D582,B10001)	3.15E-05	1.056E-02	9.963E-03	8.460E-03	1.178E-02	1.178E-02	7.271E-03
GR(D582,B10004)	7.55E-05	2.583E-02	2.445E-02	2.095E-02	2.868E-02	2.868E-02	1.818E-02
GR(D582,B10005)	7.15E-06	2.689E-03	2.544E-03	2.176E-03	2.988E-03	2.987E-03	1.885E-03
GR(D582,B10010)	5.65E-05	1.643E-02	1.543E-02	1.291E-02	1.848E-02	1.847E-02	1.092E-02
GR(D583,B10001)	2.96E-05	9.694E-03	9.149E-03	7.769E-03	1.082E-02	1.081E-02	6.677E-03
GR(D583,B10004)	7.78E-05	2.589E-02	2.451E-02	2.100E-02	2.875E-02	2.874E-02	1.822E-02
GR(D583,B10005)	9.68E-06	3.065E-03	2.900E-03	2.481E-03	3.406E-03	3.405E-03	2.149E-03
GR(D583,B10010)	4.91E-05	1.427E-02	1.341E-02	1.122E-02	1.605E-02	1.605E-02	9.486E-03



PLANCK ITP-170-P – Temperature considered with uncertainty							
NODES	GR [W/K <sup>4</sup> ]	A1	A2	A3	B1	B2	C
		Heat Flow [ W ]	Heat Flow [ W ]	Heat Flow [ W ]	Heat Flow [ W ]	Heat Flow [ W ]	Heat Flow [ W ]
GR(D584,B10001)	3.65E-05	1.186E-02	1.120E-02	9.532E-03	1.322E-02	1.321E-02	8.203E-03
GR(D584,B10004)	7.23E-05	2.403E-02	2.276E-02	1.954E-02	2.665E-02	2.663E-02	1.698E-02
GR(D584,B10005)	7.37E-06	2.289E-03	2.167E-03	1.858E-03	2.541E-03	2.540E-03	1.612E-03
GR(D584,B10010)	8.88E-05	2.854E-02	2.683E-02	2.250E-02	3.208E-02	3.206E-02	1.905E-02
GR(D585,B10001)	3.68E-05	9.840E-03	9.341E-03	8.058E-03	1.085E-02	1.085E-02	7.014E-03
GR(D585,B10004)	7.40E-05	2.103E-02	2.002E-02	1.744E-02	2.307E-02	2.306E-02	1.534E-02
GR(D585,B10005)	8.84E-06	2.579E-03	2.455E-03	2.134E-03	2.832E-03	2.831E-03	1.874E-03
GR(D585,B10010)	6.33E-05	1.477E-02	1.395E-02	1.183E-02	1.643E-02	1.643E-02	1.012E-02
GR(D586,B10001)	3.49E-05	9.632E-03	9.146E-03	7.896E-03	1.062E-02	1.062E-02	6.876E-03
GR(D586,B10004)	7.53E-05	2.063E-02	1.964E-02	1.712E-02	2.262E-02	2.261E-02	1.507E-02
GR(D586,B10005)	1.01E-05	2.628E-03	2.502E-03	2.177E-03	2.885E-03	2.884E-03	1.912E-03
GR(D586,B10010)	4.09E-05	1.092E-02	1.031E-02	8.759E-03	1.215E-02	1.214E-02	7.490E-03
GR(D587,B10001)	4.86E-05	1.252E-02	1.190E-02	1.029E-02	1.380E-02	1.379E-02	8.972E-03
GR(D587,B10004)	6.69E-05	1.836E-02	1.750E-02	1.528E-02	2.012E-02	2.011E-02	1.346E-02
GR(D587,B10005)	6.18E-06	1.746E-03	1.663E-03	1.450E-03	1.915E-03	1.914E-03	1.275E-03
GR(D587,B10010)	1.21E-04	2.471E-02	2.335E-02	1.987E-02	2.747E-02	2.746E-02	1.700E-02
GR(D588,B10001)	4.74E-05	1.124E-02	1.070E-02	9.307E-03	1.233E-02	1.233E-02	8.154E-03
GR(D588,B10004)	6.65E-05	1.732E-02	1.655E-02	1.453E-02	1.889E-02	1.889E-02	1.287E-02
GR(D588,B10005)	8.00E-06	1.998E-03	1.907E-03	1.672E-03	2.181E-03	2.180E-03	1.478E-03
GR(D588,B10010)	7.07E-05	1.350E-02	1.279E-02	1.093E-02	1.495E-02	1.495E-02	9.394E-03
GR(D589,B10001)	4.51E-05	1.073E-02	1.021E-02	8.887E-03	1.176E-02	1.176E-02	7.789E-03
GR(D589,B10004)	6.78E-05	1.786E-02	1.706E-02	1.499E-02	1.947E-02	1.947E-02	1.328E-02
GR(D589,B10005)	8.90E-06	2.541E-03	2.427E-03	2.129E-03	2.774E-03	2.773E-03	1.883E-03
GR(D589,B10010)	4.29E-05	9.485E-03	8.983E-03	7.681E-03	1.050E-02	1.050E-02	6.605E-03
GR(D590,B10001)	1.91E-05	4.802E-03	4.575E-03	3.987E-03	5.263E-03	5.261E-03	3.497E-03
GR(D590,B10004)	9.92E-05	2.503E-02	2.393E-02	2.106E-02	2.728E-02	2.727E-02	1.867E-02
GR(D590,B10005)	5.78E-05	1.453E-02	1.388E-02	1.220E-02	1.585E-02	1.584E-02	1.079E-02
GR(D590,B10010)	1.04E-04	2.147E-02	2.034E-02	1.742E-02	2.376E-02	2.375E-02	1.499E-02
GR(D591,B10001)	1.80E-05	5.171E-03	4.896E-03	4.206E-03	5.734E-03	5.732E-03	3.641E-03
GR(D591,B10004)	9.17E-05	2.887E-02	2.742E-02	2.377E-02	3.185E-02	3.184E-02	2.078E-02
GR(D591,B10005)	6.67E-05	2.214E-02	2.102E-02	1.820E-02	2.445E-02	2.444E-02	1.588E-02
GR(D591,B10010)	1.45E-04	3.989E-02	3.759E-02	3.180E-02	4.462E-02	4.460E-02	2.705E-02
GR(D592,B10001)	2.51E-05	7.137E-03	6.759E-03	5.808E-03	7.916E-03	7.913E-03	5.028E-03
GR(D592,B10004)	9.47E-05	2.898E-02	2.753E-02	2.387E-02	3.198E-02	3.197E-02	2.088E-02
GR(D592,B10005)	5.93E-05	1.801E-02	1.710E-02	1.480E-02	1.989E-02	1.988E-02	1.292E-02
GR(D592,B10010)	1.10E-04	2.730E-02	2.573E-02	2.177E-02	3.054E-02	3.053E-02	1.852E-02
GR(D593,B10001)	1.95E-05	4.785E-03	4.551E-03	3.951E-03	5.261E-03	5.259E-03	3.452E-03
GR(D593,B10004)	9.09E-05	2.451E-02	2.338E-02	2.050E-02	2.680E-02	2.679E-02	1.810E-02
GR(D593,B10005)	7.36E-05	1.896E-02	1.808E-02	1.583E-02	2.075E-02	2.075E-02	1.395E-02
GR(D593,B10010)	1.52E-04	3.136E-02	2.967E-02	2.533E-02	3.480E-02	3.479E-02	2.172E-02

PLANCK ITP-170-P – Temperature considered with uncertainty							
NODES	GR [W/K <sup>4</sup> ]	A1	A2	A3	B1	B2	C
		Heat Flow [ W ]	Heat Flow [ W ]	Heat Flow [ W ]	Heat Flow [ W ]	Heat Flow [ W ]	Heat Flow [ W ]
GR(D594,B10001)	3.14E-05	8.126E-03	7.732E-03	6.721E-03	8.931E-03	8.928E-03	5.878E-03
GR(D594,B10004)	8.85E-05	2.348E-02	2.241E-02	1.967E-02	2.566E-02	2.565E-02	1.738E-02
GR(D594,B10005)	6.53E-05	1.653E-02	1.577E-02	1.381E-02	1.808E-02	1.807E-02	1.219E-02
GR(D594,B10010)	1.06E-04	2.590E-02	2.452E-02	2.095E-02	2.874E-02	2.873E-02	1.798E-02
GR(D595,B10001)	2.07E-05	5.143E-03	4.902E-03	4.280E-03	5.629E-03	5.628E-03	3.760E-03
GR(D595,B10004)	8.70E-05	2.122E-02	2.029E-02	1.790E-02	2.310E-02	2.309E-02	1.589E-02
GR(D595,B10005)	8.21E-05	2.072E-02	1.981E-02	1.744E-02	2.258E-02	2.257E-02	1.546E-02
GR(D595,B10010)	1.41E-04	2.867E-02	2.717E-02	2.332E-02	3.169E-02	3.168E-02	2.009E-02
GR(D595,B10011)	4.74E-06	1.009E-03	9.623E-04	8.418E-04	1.103E-03	1.103E-03	7.409E-04
<b>Total Heat Flux [ W ] :</b>		<b>2.148</b>	<b>1.906</b>	<b>1.911</b>	<b>2.453</b>	<b>2.452</b>	<b>1.534</b>

Table 7.2-7 PLANCK - ITP-170-P

PLANCK ITP-220-P						
NODE	Requirement		Results			
	FFT @ 1/5000 Hz [K]	FFT @ 1/60 Hz [K]	FFT @ 1/5000 Hz [K]	Status	FFT @ 1/60 Hz [K]	Status
<b>COLD CASE</b>						
10021	0.02	0.02	2.527*10 <sup>-6</sup>	Compl.	1.252*10 <sup>-9</sup>	Compl.
10022	0.02	0.02	2.269*10 <sup>-6</sup>	Compl.	9.485*10 <sup>-10</sup>	Compl.
10023	0.02	0.02	4.539*10 <sup>-6</sup>	Compl.	2.048*10 <sup>-9</sup>	Compl.
10024	0.02	0.02	4.277*10 <sup>-6</sup>	Compl.	8.639*10 <sup>-10</sup>	Compl.
10025	0.02	0.02	1.932*10 <sup>-5</sup>	Compl.	9.234*10 <sup>-10</sup>	Compl.
10026	0.02	0.02	2.200*10 <sup>-6</sup>	Compl.	1.531*10 <sup>-9</sup>	Compl.
<b>HOT CASE</b>						
10021	0.02	0.02	3.441*10 <sup>-6</sup>	Compl.	1.93*10 <sup>-9</sup>	Compl.
10022	0.02	0.02	3.103*10 <sup>-6</sup>	Compl.	1.656*10 <sup>-9</sup>	Compl.
10023	0.02	0.02	5.553*10 <sup>-6</sup>	Compl.	1.874*10 <sup>-9</sup>	Compl.
10024	0.02	0.02	5.157*10 <sup>-6</sup>	Compl.	2.077*10 <sup>-9</sup>	Compl.
10025	0.02	0.02	1.902*10 <sup>-5</sup>	Compl.	3.275*10 <sup>-9</sup>	Compl.
10026	0.02	0.02	2.918*10 <sup>-6</sup>	Compl.	3.473*10 <sup>-9</sup>	Compl.

Table 7.2-8 PLANCK - ITP-220-P

PLANCK ITP-230-P					
Panels	Requirement	COLD CASE		HOT CASE	
	SD @ 1/60 Hz [K/Hz <sup>0.5</sup> ]	SD @ 1/60 Hz [K/Hz <sup>0.5</sup> ]	Status	SD @ 1/60 Hz [K/Hz <sup>0.5</sup> ]	Status
Pan +Z (3001-3048)	0.01	3.361*10 <sup>-7</sup>	Compl	3.702*10 <sup>-7</sup>	Compl
Pan +Y+Z (3101-3172)	0.01	2.721*10 <sup>-6</sup>	Compl	5.518*10 <sup>-6</sup>	Compl
Pan +Y (3201-3248)	0.01	2.404*10 <sup>-7</sup>	Compl	3.32*10 <sup>-7</sup>	Compl
Pan +Y-Z (3301-3372)	0.01	2.279*10 <sup>-6</sup>	Compl.	2.473*10 <sup>-6</sup>	Compl.
Pan -Z (3401-3448)	0.01	3.097*10 <sup>-6</sup>	Compl.	3.835*10 <sup>-6</sup>	Compl.
Pan -Y-Z (3501-3572)	0.01	1.937*10 <sup>-5</sup>	Compl.	1.131*10 <sup>-6</sup>	Compl
Pan -Y (3601-3648)	0.01	2.046*10 <sup>-6</sup>	Compl	2.894*10 <sup>-6</sup>	Compl
Pan -Y+Z (3701-3772)	0.01	1.046*10 <sup>-6</sup>	Compl	2.686*10 <sup>-6</sup>	Compl

Table 7.2-9 PLANCK - ITP-230-P

PLANCK ITI-030-P					
COLD CASE					
Node	Unit	Max [K/s]	Req. [K/s]	Status	Margin [k/s]
522	PAU	0.000028	0.000833	Compl.	
519/520/521	BEU	0.000016	0.000833	Compl.	
525	DAE	0.000029	0.000833	Compl.	
Node	Unit	Max [K/s]	GOAL [K/s]	Status	Margin [k/s]
522	PAU	0.000028	0.000305556	Compl.	
519/520/521	BEU	0.000016	5.55556*10 <sup>-5</sup>	Compl.	
525	DAE	0.000029	5.55556*10 <sup>-5</sup>	Compl.	
HOT CASE					
Node	Unit	Max [K/s]	Req. [K/s]	Status	Margin [k/s]
522	PAU	0.000029	0.000833	Compl.	
519/520/521	BEU	0.00002	0.000833	Compl.	
525	DAE	0.000029	0.000833	Compl.	
Node	Unit	Max [K/s]	GOAL [K/s]	Status	Margin [k/s]
522	PAU	0.000029	0.000305556	Compl.	
519/520/521	BEU	0.00002	5.55556*10 <sup>-5</sup>	Compl.	
525	DAE	0.000029	5.55556*10 <sup>-5</sup>	Compl.	

Table 7.2-10 PLANCK - ITI-030-P

In the following table 4.2-10 the maximum value of BED fluctuation for every single absorbing bed is reported, both in cold (cases P1 and P2) and hot cases (cases Q1 and Q2).

CASE	Cooling BED	BED#1	BED#2	BED#3	BED#4	BED#5	BED#6
P1 – BOL SCC1 on	5		4.35	4.36	6.88		
	6			4.37	4.38	6.71	
	1				4.43	4.43	6.75
	2	6.78				4.37	4.38
	3	4.38	6.82				4.37
	4	4.37	4.38	6.86			
P2 – BOL SCC2 on	5		4.56	4.57	7.26		
	6			4.58	4.58	7.10	
	1				4.58	4.59	7.13
	2	7.16				4.58	4.59
	3	4.91	7.20				4.90
	4	4.71	4.72	6.82			
Q1 – EOL SCC1 on	5		4.87	4.88	7.98		
	6			4.89	4.90	7.79	
	1				4.89	4.90	7.83
	2	7.87				4.90	4.90
	3	4.90	7.91				4.90
	4	4.90	4.90	7.95			
Q2 – EOL SCC2 on	5		5.12	5.12	8.39		
	6			5.13	5.14	8.22	
	1				5.13	5.14	8.25
	2	8.29				5.13	5.14
	3	5.14	8.33				5.13
	4	5.12	5.13	8.37			

Table 7.2-11a PLANCK – SCC STABILITY

<b>BOL SCC1 on (COLD case)</b>		
	Requirement	Requirement
	[ 0.1°C / hr ]	[ 0.25°C / day ]
Max Delta T 920-925	<b>0.009</b>	<b>-0.120</b>
Max Delta T 920-930	<b>-0.042</b>	<b>-0.145</b>
Max Delta T 925-930	<b>-0.034</b>	<b>-0.028</b>
<b>BOL SCC2 on(COLD case)</b>		
	Requirement	Requirement
	[ 0.1°C / hr ]	[ 0.25°C / day ]
Max Delta T 920-925	<b>-0.008</b>	<b>-0.103</b>
Max Delta T 920-930	<b>-0.042</b>	<b>-0.141</b>
Max Delta T 925-930	<b>-0.034</b>	<b>-0.040</b>
<b>EOL SCC1 on (HOT case)</b>		
	Requirement	Requirement
	[ 0.1°C / hr ]	[ 0.25°C / day ]
Max Delta T 920-925	<b>0.008</b>	<b>-0.107</b>
Max Delta T 920-930	<b>-0.042</b>	<b>-0.131</b>
Max Delta T 925-930	<b>-0.035</b>	<b>-0.034</b>
<b>EOL SCC2 on (HOT case)</b>		
	Requirement	Requirement
	[ 0.1°C / hr ]	[ 0.25°C / day ]
Max Delta T 920-925	<b>0.009</b>	<b>-0.134</b>
Max Delta T 920-930	<b>-0.042</b>	<b>-0.132</b>
Max Delta T 925-930	<b>-0.035</b>	<b>-0.011</b>
	BOL – EOL SCC1 on	BOL – EOL SCC2 on
	Requirement	Requirement
	[ 1.5°C / life ]	[ 1.5°C / life ]
Max Delta T 920-925	<b>1.650</b>	<b>1.624</b>
Max Delta T 920-930	<b>-0.469</b>	<b>-0.463</b>
Max Delta T 925-930	<b>-1.809</b>	<b>-1.761</b>

Table 7.2.11b PLANCK – gradient between each tank

## 8 THERMAL ANALYSIS

In the thermal analysis, the presence of heater, controlled by means thermistors, has been simulated comparing the temperature with two fixed thresholds. The simulation of this control is relatively simply in the transient case: if the controlled node has a temperature below the on-threshold the heater dissipation is considered in the TMM; if the temperature is above the off-threshold the heaters dissipation is set at 0 W; if the temperature is within the “on threshold” and “off threshold” the heater status of “on” or “off” doesn’t change.

### 8.1 HERSCHEL Thermal Analysis

Two fins on the +Y and –Y Panel have been designed to eliminate the Solar Flux on the two Panels as described in the Design Report AD7.

Due to the use of these fins, the difference on the Temperature results between the case with a rotation of +1deg. and –1deg.° around X-axis, is lower then 1 °C.

For this reason, the Cold Cases were performed using only one position (Rot X= –1°).

#### TRANSIENT CASE

According to AD9, the following sizing cases have been performed:

**Case A÷F** = Hot Cases in worst Attitude (–30° around the Yaxis and +/- 1° on the Xaxis) and in operating Modes:

- Mode 1 (sizing for HIFI units)
- Mode 2 (sizing for PACS units) in Photometry or Spectroscopy
- TT&C in Nominal mode (21h in Telecom 3h in Scientific)

**Case G÷H** = Cold Cases in worst Attitude, (+30° around the Yaxis) and in operating Modes:

- Mode 1 (sizing for HIFI)
- Mode 3 (sizing for SPIRE)
- TT&C in Nominal Mode (21h in Telecom 3h in Scientific)

**Case I** = Cold Case in Survival Attitude, (+5° around the Yaxis) and in operating Modes:

- Survival = all warm units are Switched-Off
- TT&C in Telecom Mode

In all the Nominal Cases from A to H some control are activated:

- the HIFI units FHWOV and FHWOH are controlled by a Fine Control Law at the set point 9°C
- the STR baseplate is controlled by a Fine Control Law at the set point –2.2°C
- the GYRO unit is controlled at the set point 63°C within 1°C

Solar constant values are defined in [AD9].

CASE	BOL/ EOL	SUN ON PANEL	SAA [deg]	ATTITUDE	SOLAR CONSTANT [W/m <sup>2</sup> ]	DISSIPATION MODE
A	EOL	+X+Y	30	Rot X = +1 Rot Y = -30	Winter: 1405	TT&C Nominal / MODE1
B	EOL	+X+Y	30	Rot X = +1 Rot Y = -30	Winter: 1405	TT&C Nominal / MODE2 Photometry
C	EOL	+X+Y	30	Rot X = +1	Winter: 1405	TT&C Nominal / MODE2 Spectroscopy

CASE	BOL/ EOL	SUN ON PANEL	SAA [deg]	ATTITUDE	SOLAR CONSTANT [W/m <sup>2</sup> ]	DISSIPATION MODE
				Rot Y = -30		
D	EOL	+X-Y	30	Rot X = -1 Rot Y = -30	Winter: 1405	TT&C Nominal / MODE1
E	EOL	+X-Y	30	Rot X = -1 Rot Y = -30	Winter: 1405	TT&C Nominal / MODE2 Photometry
F	EOL	+X-Y	30	Rot X = -1 Rot Y = -30	Winter: 1405	TT&C Nominal / MODE2 Spectroscopy
G	BOL	+X-Y	30	Rot X = -1 Rot Y = +30	Summer: 1285	TT&C Nominal / MODE3
H	BOL	+X-Y	30	Rot X = -1 Rot Y = +30	Summer: 1285	TT&C Nominal / MODE1
I	BOL	+X-Y	5	Rot X = 0 Rot Y = +5	Summer: 1285	TT&C Telecom / SurvivalBOL

Table 8.1-1 HERSCHEL – Analysis Cases

### TRANSIENT WITH ATTITUDE CHANGE

Two Cases with an Attitude Change have been performed with the Warm Units in MODE1: P and Q.

The scope of these transients is to verify the stability requirements. As reported in Requirements paragraph, the stability is reached for all the units that have a requirement.

A fine control law is implemented on the STR, -Y Panel Unit FHWOH and on the -Y-Z Unit FHWOV the units that require a dedicated heater power in nominal conditions.

The analysed cases are:

- P: Cold Transient:
  - Starting from a temperature level corresponding to a BOL with Sun on +X -Y axis, SAA=+30°/-1° in Summer season
  - Ending to a BOL case with Sun on -X -Y axis, SAA=-30°/-1° in Summer season
  - Warm Units in MODE1
  - TT&C units: 21 hours Scientific Mode and 3 hours Telecom Mode
  - Nominal heater dissipations
  - Fine control law on Units: FHWOV, FHWOH, STR.
  - GYRO controlled within 1°C at set-point
  - Duration of change of attitude (7°/min): 514s
  - Overall duration of transient case: 130 h
  
- Q: Hot Transient:
  - Starting from a temperature level corresponding to a EOL case with Sun on +X -Y axis, SAA=+30°/-1° in Winter season
  - Ending to a EOL case with Sun on -X -Y axis, SAA=-30°/-1° in Winter season
  - Warm Units in MODE1
  - TT&C units: 21 hours Scientific Mode and 3 hours Telecom Mode
  - Nominal heater dissipations
  - Fine control law on Units: FHWOV, FHWOH, STR.
  - GYRO controlled within 1°C at set-point
  - Duration of change of attitude (7°/min): 514s



- Overall duration of transient case: 130 h

#### REDUNDANCY TRANSIENT ANALYSIS

A series of additional analysis have been performed to verify the temperatures behaviour when the redundancy units are activated. The analysis results are reported in paragraph 8.4.4

## 8.2 Herschel Heater Sizing and Breakdown

A heater definition approach was followed in order to define the heater power needed by the TCS.

For this scope a heater power uncertainty analysis has been performed [AD22].

The Heater circuit breakdown with the heater power impressed on the TMM nodes is shown in Table 8.2-1.

The threshold operative and not operative are listed in the table, but also in the survival case the operative threshold are used (except for the control law that are inactive) to maintain the SVM temperature level sufficiently high. The RCS temperature in survival are critical and this solution can avoid other design impacts.

Heater line	TCS ID	HEATER's location	Heaters on Node	Power on node [W]	Power line @27 V [W]	UNIT ON Threshold [°C]	SURVIVAL Threshold [°C]	UNIT OFF Threshold [°C]
TCS Line 01	HTR104NS	close to XPND1	6134	11.39	11.39	-9/-6	-9/-6	-19/-16
TCS Line 02	HTR105NS	close to XPND2	6110	11.39	11.39	-9/-6	-9/-6	-19/-16
TCS Line 03	HTR204NS	inside BATTERY	204	14.9	14.90	1/4	1/4	1/4
TCS Line 05	HTR301S	close to FPSPU, FPDPU	6309	15.51	31.00	-14/-11	-14/-11	-29/-26
			6313	15.51/2				
			6314	15.51/2				
TCS Line 06	HTR304NS	close to FPBOLC	6338	4.7	9.40	-14/-11	-14/-11	-29/-26
			6324	4.7				
TCS Line 08	HTR305S	close to FPDECMEC	6342	11.39	27.48	-14/-11	-14/-11	-29/-26
			6320	11.39				
			6344	4.7				
TCS Line 09	HTR1523NS	Pipes	-	-	5.57	+23/+24	+23/+24	+23/+24
TCS Line 10	HTR401S	close to CCU, HSDCU, HSFCU	6402	4.7	44.50	-9/-6	-9/-6	-19/-16
			6416	8.1				
			6428	8.1				
			6446	15.51				
			6421	8.1				
TCS Line 11	HTR1562	Pipes	-	-	6.13	+23/+24	+23/+24	+23/+24
TCS Line 12	HTR501NS	Close to FHWOV	654702	11.39/4	22.80	C.L.	0/+3	-24/-21
			654706	11.39/4				
			654710	11.39/8				
			653914	11.39/4				
			653910	11.39/8				
			653203	11.39/4				
			653207	11.39/4				
			653211	11.39/4				
653215	11.39/4							
TCS Line 13	HTR502S	Close to FHHRV	6551	8.1	39.00	-9/-6	-9/-6	-24/-21
			6567	8.1				
			6553	11.39				
			6569	11.39				
TCS Line 14	HTR504S	close to FHFCU	6541	4.7	20.79	-9/-6	-9/-6	-24/-21
			6527	11.39				
			6533	4.7				
TCS Line 15	HTR506S	close to FHWEV,	6528	8.1	35.70	1 / 4	1 / 4	-24/-21

Heater line	TCS ID	HEATER's location	Heaters on Node	Power on node [W]	Power line @27 V [W]	UNIT ON Threshold [°C]	SURVIVAL Threshold [°C]	UNIT OFF Threshold [°C]
		FHICU	6530	11.39				
			6521	8.1				
			6506	8.1				
TCS Line 16	HTR601NS	close to FHWOH	660606	8.1/3	32.40	C.L.	0/+3	-24/-21
			660607	8.1/3				
			660608	8.1/3				
			662009	8.1/3				
			662010	8.1/3				
			661912	8.1/3				
			661811	8.1/3				
			661812	8.1/3				
			660812	8.1/3				
			660816	8.1/3				
			661909	8.1/3				
			662004	8.1/3				
TCS Line 17	HTR602S	close to FHWEH	6603	8.1	32.40	1 / 4	1 / 4	-24/-21
			6605	8.1				
			6615	8.1				
			6617	8.1				
TCS Line 18	HTR603S	close to FHHRH	6664	11.39	39.00	-9/-6	-9/-6	-24/-21
			6665	8.1/2				
			6666	8.1/2				
			6627	8.1				
			6628	11.39/2				
			6629	11.39/2				
TCS Line 19	HTR604S	close to FHLCU, FHIFH	6634	8.1	20.90	-9/-6	-9/-6	-24/-21
			6670	8.1				
			6635	4.7*2/3				
			6636	4.7/3				
TCS Line 20	HTR605S	close to FHLSU	6654	8.1	29.00	11/14	11/14	-24/-21
			6656	8.1				
			6630	8.1				
			6632	4.7				
TCS Line 21	HTR702NS	on RWL2	702	11.39	11.39	+1/+4	+1/+4	-9/-6
TCS Line 22	HTR704NS	on RWL4	704	11.39	11.39	+1/+4	+1/+4	-9/-6
TCS Line 23	HTR701NS	on RWL1	701	11.39	11.39	+1/+4	+1/+4	-9/-6
TCS Line 24	HTR703NS	on RWL3	703	11.39	11.39	+1/+4	+1/+4	-9/-6
TCS Line 25	HTR70NS	on TANK +Y	70	6.17	6.17	11/14	11/14	11/14
TCS Line 26	HTR71NS	on TANK -Y	71	6.17	6.17	11/14	11/14	11/14
TCS Line 27	HTR2000NS	close to STR's	20002	1.32	21.10	C.L.	-29/-26	-29/-26
			20003	1.32				
			20006	1.32				
			20007	1.32				
			20009	1.32				

Heater line	TCS ID	HEATER's location	Heaters on Node	Power on node [W]	Power line @27 V [W]	UNIT ON Threshold [°C]	SURVIVAL Threshold [°C]	UNIT OFF Threshold [°C]
			20017	1.32				
			20028	1.32				
			20029	1.32				
			20004	1.32				
			20005	1.32				
			20016	1.32				
			20024	1.32				
			20026	1.32				
			20027	1.32				
			20030	1.32				
			20031	1.32				
TCS Line 28	HTR507NS	on FH3DV	6545	11.39/2	11.39	C.L.	-24/-21	-24/-21
			6544	11.39/2				
TCS Line 29	HTR8133NS	on FCV A1A	8133	1.43	1.43	11/14	11/14	11/14
TCS Line 30	HTR8233NS	on FCV C2A	8233	1.43	1.43	11/14	11/14	11/14
TCS Line 31	HTR8333NS	on FCV C1A	8333	1.43	1.43	11/14	11/14	11/14
TCS Line 32	HTR8433NS	on FCV A2A	8433	1.43	1.43	11/14	11/14	11/14
TCS Line 33	HTR8533NS	on FCV C4A	8533	1.43	1.43	11/14	11/14	11/14
TCS Line 34	HTR8633NS	on FCV C3A	8633	1.43	1.43	11/14	11/14	11/14
TCS Line 35	HTR1544NS	Pipes			5.27	+23/+24	+23/+24	+23/+24
TCS Line 37	HTR1554NS	Pipes			9.9	+23/+24	+23/+24	+23/+24
TCS Line 38	HTR100NS	on GYRO	81	45.22	45.22	62.5/63	62.5/63	-24/-21
TCS Line 39	HTR8134NS	on FCV A1B	8134	1.43	1.43	11/14	11/14	11/14
TCS Line 40	HTR8234NS	on FCV C2B	8234	1.43	1.43	11/14	11/14	11/14
TCS Line 41	HTR8334NS	on FCV C1B	8334	1.43	1.43	11/14	11/14	11/14
TCS Line 42	HTR8434NS	on FCV A2B	8434	1.43	1.43	11/14	11/14	11/14
TCS Line 43	HTR8534NS	on FCV C4B	8534	1.43	1.43	11/14	11/14	11/14
TCS Line 44	HTR8634NS	on FCV C3B	8634	1.43	1.43	11/14	11/14	11/14
TCS Line 45	HTR1513NS	Pipes	-	-	5.75	+23/+24	+23/+24	+23/+24
TCS Line 46	HTR1506NS	Pipes	-	-	4.68	+23/+24	+23/+24	+23/+24
TCS Line 47	HTR1535NS	Pipes	-	-	4.82	+23/+24	+23/+24	+23/+24
TCS Line 48	HTR1550NS	PT LV1 LV2 LF	-	-	4.9	+23/+24	+23/+24	+23/+24

Table 8.2-1 HERSCHEL – Heater Circuits Breakdown and Temperature Thresholds

### 8.3 Thermal stability

In order to meet the stability requirement for the units having an heater control (501 FHWOV, 601 FWHOH, Star trackers) an adequate control law has been designed.

A dedicated set of thermal analyses (transient cases) has been performed in order to verify the stability requirement.

The description of the control law criterion with the thermal analysis results is reported in [AD23].

## 8.4 Herschel Thermal analysis results

### 8.4.1 Transient Results

The temperature results hereafter presented (Tables 8.4.1-1 to 8.4.1-4) refer to the Sizing Cases reported in paragraph 8.1. The Temperatures values are reported with and without uncertainty for all the Units according to the uncertainty analysis [AD21]. The units actively controlled don't have any uncertainty: GYRO, FHWOV, FHWOH, STR1.

The temperature uncertainty used is generally 8 °C ([AD21], with control law case) except for the units:

- With uncertainty higher than 8°C. The real value is considered.
- With temperature higher than maximum limit. The real value is considered.

For the survival case the reference uncertainty is always takes from [AD21] but for the case without control law.

The Gyro has to be controlled in temperature in way that its temperature not changes more than 1 °C.

For this reason calculated the maximum temperature in EOL (Hot case) the threshold of heater switch-on has been defined about 1°C less (62°C). Of course when the analysis condition request heater no uncertainty will be applied at the Gyro, while if the temperature is higher than the heater threshold value will be applied the uncertainty calculated without control (8.5 °C, see [AD21]).

The Tables contain for the main S/L items, the relevant TMM node, its description, the temperature results in the transient nominal analysis with the minimum values reported for the Cold cases and the maximum values reported for the Hot cases, the uncertainty applied, the temperature with the relative uncertainty applied, the heater enabled according to the case analysed (identified by the "h" reported near the temperature value), the operative and non operative limits. All the temperatures are in degree Celsius.

NODE	LABEL	TEMPERATURE RESULTS AND LIMITS										
		G	G	H	H	UFP [°C]	G	H	MIN OPER. [°C]	MAX OPER. [°C]	MIN N.OPER [°C]	MAX N.OPER [°C]
		TEMP [°C]	PW [W]	TEMP [°C]	PW [W]		TEMP- UFP [°C]	TEMP-UFP [°C]				
4	VMC	6.5	0.0	6.7	0.0	7.4	-0.9	-0.8	-10	50	-20	60
5	SAS HOUSING +Z	21.1	0.0	21.2	0.0	8	13.1	13.2	-70	80	-80	90
16	MGA+Z SEPTUM	65.5	0.6	65.5	0.6	12.4	53.1	53.1	-150	150	-150	150
21	LGA+Z	57.1	0.0	57.2	0.0	8	49.1	49.2	-150	120	-150	120
41	LGA-Z	-64.2	0.0	-64.2	0.0	8	-72.2	-72.2	-150	120	-150	120
45	SAS HOUSING -Z	-16.0	0.0	-15.8	0.0	8	-24.0	-23.8	-70	80	-80	90
49	WINDOW SREM	4.9	2.6	5.1	2.6	8	-3.1	-2.9	-10	50	-45	90
56	AAD HOUSING	46.4	0.0	46.5	0.0	8	38.4	38.5	-70	70	-80	80
70	TANK1	11.0	0.0	11.0	0.0	0	11.0h	11.0h	10	45	10	45
71	TANK2	11.0	0.0	11.0	0.0	0	11.0h	11.0h	10	45	10	45
81	GYRO_D1	62.1	0.0	62.1	0.0	0	62.1h	62.1h	-15	65	-25	65
101	RFDN	2.0	11.8	2.1	11.8	8	-6.0	-5.9	-25	55	-35	65
122	EPC1_D1	5.1	9.0	5.1	9.0	8	-2.9	-2.9	-20	60	-30	70
123	EPC2_D1	-10.8	0.0	-10.7	0.0	8.2	-19.0	-18.9	-20	60	-30	70
104	TRANSX1	10.9	21.0	10.9	21.0	7.6	3.3	3.3	-10	45	-20	55
105	TRANSX2	-3.0	10.0	-2.9	10.0	0	-3.0h	-2.9h	-10	45	-20	55
126	TWTA1_D1	6.5	0.0	6.6	0.0	7.9	-1.4	-1.3	-20	60	-30	70
127	TWTA2_D1	-10.9	0.0	-10.9	0.0	8.1	-19.0	-19.0	-20	60	-30	70
146	TWTA1_HEAD_D1	7.1	32.0	7.1	32.0	7.9	-0.8	-0.8	-20	60	-30	70
147	TWTA2_HEAD_D1	-11.2	0.0	-11.1	0.0	8.1	-19.3	-19.2	-20	60	-30	70
130	CRS1_D1	17.1	8.3	17.2	8.3	7.3	9.8	9.9	0	50	-10	60
131	CRS2_D1	17.7	8.3	17.8	8.3	7.3	10.4	10.5	0	50	-10	60
221	PCDU_D1	9.9	72.8	9.9	72.8	8	1.9	1.9	-10	47	-20	57
222	CDMU_D1	9.2	37.7	9.3	37.7	8	1.2	1.3	-10	45	-20	55
223	ACC_D1	11.7	32.1	11.8	32.1	8	3.7	3.8	-10	45	-20	55
204	BATT	1.0	0.0	1.0	0.0	0	1.0h	1.0h	0	35	0	35

NODE	LABEL	TEMPERATURE RESULTS AND LIMITS										
		G	G	H	H	UFP [°C]	G	H	MIN OPER. [°C]	MAX OPER. [°C]	MIN N.OPER [°C]	MAX N.OPER [°C]
		TEMP [°C]	PW [W]	TEMP [°C]	PW [W]		TEMP- UFP [°C]	TEMP-UFP [°C]				
321	FPSPU1_2_D1	12.7	30.3	12.8	30.3	8	4.7	4.8	-15	45	-30	60
323	FPDPU_D1	4.2	24.0	4.3	24.0	8	-3.9	-3.7	-15	45	-30	60
324	FPBOLC_D1	-6.8	6.6	-6.7	6.6	8	-14.8	-14.7	-15	45	-30	60
325	FPMECDEC_D1	0.6	20.9	0.7	20.9	8	-7.4	-7.3	-15	45	-30	60
401	CCU	7.6	5.4	8.0	5.4	8	-0.4	0.0	-10	40	-20	50
424	HSDCU_D1	11.5	37.0	11.8	37.0	8	3.5	3.8	-15	45	-35	60
425	HSDPU_D1	9.8	15.3	9.9	15.3	8	1.8	1.9	-15	45	-35	60
426	HSFCU_D1	12.9	42.9	13.0	42.9	8	4.9	5.0	-15	45	-35	60
521	FHWOV_D1_BASEPLATE	9.0	1.5	9.0	1.5	0	9.0c.l.	9.0c.l.	5	15	-25	55
522	FHHRV_D1	16.2	66.3	17.0	66.3	9	7.2	8.0	-10	40	-25	55
523	FHICU_D1	12.5	29.0	14.3	31.4	8.3	4.2	6.0	-25	40	-30	60
524	FHFCU_D1	10.0	13.0	10.7	13.0	8	2.0	2.7	-10	40	-25	55
526	FHWEV_D1	10.1	25.7	10.6	25.7	8	2.1	2.6	0	30	-25	55
507	FHIFV_D1	7.0	0.0	7.0	0.3	0	7.0c.l.	7.0c.l.	-10	40	-25	55
508	IFV-HRV	10.0	0.0	10.8	0.0	9	1.0	1.8	-10	40	-25	55
509	IFV-WEV	10.2	0.0	11.1	0.0	9	1.2	2.1	-10	40	-25	55
510	WOV-WEV	8.6	0.0	9.4	0.0	9	-0.4	0.4	-10	40	-25	55
511	HRV-HRH	12.3	0.0	14.3	0.0	9	3.3	5.3	-10	40	-25	55
621	FHWOH_D1_BASEPLATE	9.0	1.5	9.0	1.5	0	9.0c.l.	9.0c.l.	5	15	-25	55
622	FHWEH_D1	9.4	25.7	10.5	25.7	7.8	1.6	2.7	0	30	-25	55
623	FHHRH_D1	19.6	66.3	21.1	66.3	8.8	10.8	12.3	-10	40	-25	55
624	FHLCU_D1	17.6	37.6	22.5	43.4	8	9.6	14.5	-10	40	-25	55
625	FHLSU_D1	19.2	35.8	22.9	40.4	8	11.2	14.9	10	40	-25	55
606	FHIFH_D1	7.3	0.3	10.1	0.3	8	-0.7	2.1	-10	40	-25	55
607	IFH-HRH	12.5	0.0	15.0	0.0	9	3.5	6.0	-10	40	-25	55
608	IFH-WEH	12.8	0.0	15.2	0.0	9	3.8	6.2	-10	40	-25	55
609	WEH-WOH	13.9	0.0	16.5	0.0	9	4.9	7.5	-10	40	-25	55
701	RWL1	1.0	5.0	1.0	5.0	0	1.0h	1.0h	0	55	-10	65
702	RWL2	1.0	5.0	1.0	5.0	0	1.0h	1.0h	0	55	-10	65
703	RWL3	1.0	5.0	1.0	5.0	0	1.0h	1.0h	0	55	-10	65
704	RWL4	1.4	5.0	1.6	5.0	0	1.4h	1.6h	0	55	-10	65
8133	FCV BODY MAIN	14.0	0.0	14.1	0.0	0	14.0h	14.1h	10	60	10	60
8233	FCV BODY MAIN	11.0	0.0	11.0	0.0	0	11.0h	11.0h	10	60	10	60
8333	FCV BODY MAIN	11.0	0.0	11.0	0.0	0	11.0h	11.0h	10	60	10	60
8433	FCV BODY MAIN	11.0	0.0	11.0	0.0	0	11.0h	11.0h	10	60	10	60
8533	FCV BODY MAIN	11.0	0.0	11.5	0.0	0	11.0h	11.5h	10	60	10	60
8633	FCV BODY MAIN	11.8	0.0	12.2	0.0	0	11.8h	12.2h	10	60	10	60
8134	FCV BODY REDUNDANT	14.0	0.0	14.1	0.0	0	14.0h	14.1h	10	60	10	60
8234	FCV BODY REDUNDANT	11.0	0.0	11.0	0.0	0	11.0h	11.0h	10	60	10	60
8334	FCV BODY REDUNDANT	11.0	0.0	11.0	0.0	0	11.0h	11.0h	10	60	10	60
8434	FCV BODY REDUNDANT	11.0	0.0	11.0	0.0	0	11.0h	11.0h	10	60	10	60
8534	FCV BODY REDUNDANT	11.0	0.0	11.8	0.0	0	11.0h	11.8h	10	60	10	60
8634	FCV BODY REDUNDANT	11.5	0.0	11.9	0.0	0	11.5h	11.9h	10	60	10	60
80029	STR1+X FOOT	5.3	0.0	5.3	0.0	0	5.3h	5.3h	-20	40	-30	50
81029	STR2+X FOOT	-7.0	0.0	-7.0	0.0	3.8	-10.8	-10.8	-20	40	-30	50
1501	RCS #9 - LINE 1	28.8	0.0	28.8	0.0	8	20.8	20.8	10	50	10	50
1502	RCS #9 - LINE 1	28.8	0.0	28.8	0.0	8	20.8	20.8	10	50	10	50
1503	RCS #9 - LINE 1	28.8	0.0	28.8	0.0	8	20.8	20.8	10	50	10	50
1504	RCS #9 - LINE 1	28.8	0.0	28.8	0.0	8	20.8	20.8	10	50	10	50
1505	RCS #9 - LINE 1	28.8	0.0	28.8	0.0	8	20.8	20.8	10	50	10	50
1506	RCS #9 - LINE 1	22.9	0.0	22.9	0.0	8	14.9	14.9	10	50	10	50
1507	RCS #9 - LINE 1	33.0	0.0	32.9	0.0	8	25.0	24.9	10	50	10	50
1508	RCS #9 - LINE 1	23.3	0.0	23.2	0.0	8	15.3	15.2	10	50	10	50
1509	RCS #9 - LINE 1	21.7	0.0	21.8	0.0	8	13.7	13.8	10	50	10	50

NODE	LABEL	TEMPERATURE RESULTS AND LIMITS										
		G	G	H	H	UFP [°C]	G	H	MIN OPER. [°C]	MAX OPER. [°C]	MIN N.OPER [°C]	MAX N.OPER [°C]
		TEMP [°C]	PW [W]	TEMP [°C]	PW [W]		TEMP- UFP [°C]	TEMP-UFP [°C]				
1512	RCS #9 - LINE 1	19.1	0.0	19.0	0.0	8	11.1	11.0	10	50	10	50
1513	RCS #9 - LINE 1	29.3	0.0	29.2	0.0	8	21.3	21.2	10	50	10	50
1514	RCS #9 - LINE 1	23.6	0.0	23.5	0.0	8	15.6	15.5	10	50	10	50
1515	RCS #9 - LINE 1	22.0	0.0	22.0	0.0	8	14.0	14.0	10	50	10	50
1516	RCS #9 - LINE 1	24.4	0.0	24.3	0.0	8	16.4	16.3	10	50	10	50
1517	RCS #9 - LINE 1	23.8	0.0	23.7	0.0	8	15.8	15.7	10	50	10	50
1518	RCS #9 - LINE 1	22.7	0.0	22.7	0.0	8	14.7	14.7	10	50	10	50
1519	RCS #9 - LINE 1	22.2	0.0	22.1	0.0	8	14.2	14.1	10	50	10	50
1520	RCS #9 - LINE 1	24.7	0.0	24.6	0.0	8	16.7	16.6	10	50	10	50
1522	RCS #9 - LINE 1	29.4	0.0	29.4	0.0	8	21.4	21.4	10	50	10	50
1523	RCS #9 - LINE 1	23.4	0.0	23.4	0.0	8	15.4	15.4	10	50	10	50
1524	RCS #11 - LINE 2	21.1	0.0	21.1	0.0	8	13.1	13.1	10	50	10	50
1525	RCS #11 - LINE 2	21.1	0.0	21.1	0.0	8	13.1	13.1	10	50	10	50
1526	RCS #11 - LINE 2	21.4	0.0	21.5	0.0	8	13.4	13.5	10	50	10	50
1527	RCS #11 - LINE 2	21.5	0.0	21.5	0.0	8	13.5	13.5	10	50	10	50
1528	RCS #11 - LINE 2	21.5	0.0	21.5	0.0	8	13.5	13.5	10	50	10	50
1529	RCS #11 - LINE 2	23.0	0.0	22.9	0.0	8	15.0	14.9	10	50	10	50
1530	RCS #11 - LINE 2	23.0	0.0	22.9	0.0	8	15.0	14.9	10	50	10	50
1531	RCS #11 - LINE 2	21.7	0.0	21.7	0.0	8	13.7	13.7	10	50	10	50
1532	RCS #11 - LINE 2	21.4	0.0	21.2	0.0	8	13.4	13.2	10	50	10	50
1533	RCS #11 - LINE 2	25.7	0.0	25.6	0.0	8	17.7	17.6	10	50	10	50
1534	RCS #11 - LINE 2	25.7	0.0	25.6	0.0	8	17.7	17.6	10	50	10	50
1535	RCS #11 - LINE 2	25.7	0.0	25.6	0.0	8	17.7	17.6	10	50	10	50
1536	RCS #11 - LINE 2	25.7	0.0	25.6	0.0	8	17.7	17.6	10	50	10	50
1537	RCS #11 - LINE 2	23.6	0.0	23.6	0.0	8	15.6	15.6	10	50	10	50
1538	RCS #11 - LINE 2	25.6	0.0	25.5	0.0	8	17.6	17.5	10	50	10	50
1539	RCS #11 - LINE 2	22.0	0.0	22.0	0.0	8	14.0	14.0	10	50	10	50
1540	RCS #11 - LINE 2	22.0	0.0	22.0	0.0	8	14.0	14.0	10	50	10	50
1541	RCS #11 - LINE 2	21.3	0.0	21.3	0.0	8	13.3	13.3	10	50	10	50
1542	RCS #11 - LINE 2	21.0	0.0	20.9	0.0	8	13.0	12.9	10	50	10	50
1543	RCS #11 - LINE 2	22.2	0.0	21.9	0.0	9	13.2	12.9	10	50	10	50
1544	RCS #11 - LINE 2	21.8	0.0	21.7	0.0	8	13.8	13.7	10	50	10	50
1545	RCS #11 - LINE 2	21.8	0.0	21.7	0.0	8	13.8	13.7	10	50	10	50
1546	RCS #11 - LINE 2	21.8	0.0	21.7	0.0	8	13.8	13.7	10	50	10	50
1547	RCS #11 - LINE 2	21.8	0.0	21.7	0.0	8	13.8	13.7	10	50	10	50
1548	RCS #11 - LINE 2	27.6	0.0	27.2	0.0	8	19.6	19.2	10	50	10	50
1549	RCS #11 - LINE 2	22.4	0.0	22.4	0.0	8	14.4	14.4	10	50	10	50
1550	RCS #11 - LINE 2	22.4	0.0	22.4	0.0	8	14.4	14.4	10	50	10	50
1551	RCS #35 - LINE 3a	23.8	0.0	23.8	0.0	8	15.8	15.8	10	50	10	50
1552	RCS #35 - LINE 3a	23.8	0.0	23.8	0.0	8	15.8	15.8	10	50	10	50
1553	RCS #35 - LINE 3a	23.8	0.0	23.8	0.0	8	15.8	15.8	10	50	10	50
1554	RCS #35 - LINE 3a	23.8	0.0	23.8	0.0	8	15.8	15.8	10	50	10	50
1555	RCS #35 - LINE 3a	23.8	0.0	23.8	0.0	8	15.8	15.8	10	50	10	50
1556	RCS #35 - LINE 3a	22.9	0.0	22.9	0.0	8	14.9	14.9	10	50	10	50
1557	RCS #35 - LINE 3a	22.9	0.0	22.9	0.0	8	14.9	14.9	10	50	10	50
1558	RCS #35 - LINE 3a	22.9	0.0	22.9	0.0	8	14.9	14.9	10	50	10	50
1559	RCS #35 - LINE 3a	22.9	0.0	22.9	0.0	8	14.9	14.9	10	50	10	50
1560	RCS #35 - LINE 3a	23.6	0.0	23.6	0.0	8	15.6	15.6	10	50	10	50
1561	RCS #35 - LINE 3a	24.2	0.0	24.2	0.0	8	16.2	16.2	10	50	10	50
1562	RCS #35 - LINE 3a	24.7	0.0	24.6	0.0	8	16.7	16.6	10	50	10	50
1563	RCS #35 - LINE 3a	25.3	0.0	25.2	0.0	8	17.3	17.2	10	50	10	50
1564	RCS #35 - LINE 3a	25.3	0.0	25.2	0.0	8	17.3	17.2	10	50	10	50
1565	RCS #35 - LINE 3a	24.7	0.0	24.6	0.0	8	16.7	16.6	10	50	10	50
1566	RCS #35 - LINE 3a	20.6	0.0	20.5	0.0	8	12.6	12.5	10	50	10	50

NODE	LABEL	TEMPERATURE RESULTS AND LIMITS										
		G	G	H	H	UFP [°C]	G	H	MIN OPER. [°C]	MAX OPER. [°C]	MIN N.OPER [°C]	MAX N.OPER [°C]
		TEMP [°C]	PW [W]	TEMP [°C]	PW [W]		TEMP- UFP [°C]	TEMP-UFP [°C]				
1567	RCS #35 - LINE 3a	24.3	0.0	24.2	0.0	8	16.3	16.2	10	50	10	50
1450	RCS#48-3b- LF	24.1	0.0	24.1	0.0	8	16.1	16.1	10	50	10	50
1477	RCS#48-3b- LV1	23.0	0.0	23.0	0.0	8	15.0	15.0	10	50	10	50
1482	RCS#48-3b- LV2	24.1	0.0	24.1	0.0	8	16.1	16.1	10	50	10	50
1487	RCS#48-3b- PT	22.0	0.0	21.9	0.0	8	14.0	13.9	10	50	10	50
1568	RCS #37 - LINE 3c	29.3	0.0	29.3	0.0	8	21.3	21.3	10	50	10	50
1569	RCS #37 - LINE 3c	34.3	0.0	34.2	0.0	8	26.3	26.2	10	50	10	50
1570	RCS #37 - LINE 3c	37.9	0.0	37.7	0.0	8	29.9	29.7	10	50	10	50
1571	RCS #37 - LINE 3c	30.7	0.0	30.6	0.0	8	22.7	22.6	10	50	10	50
1572	RCS #37 - LINE 3c	21.1	0.0	21.1	0.0	8	13.1	13.1	10	50	10	50
1573	RCS #37 - LINE 3c	25.1	0.0	25.1	0.0	8	17.1	17.1	10	50	10	50
1574	RCS #37 - LINE 3c	25.8	0.0	25.7	0.0	8	17.8	17.7	10	50	10	50
1576	RCS #37 - LINE 3c	22.6	0.0	22.6	0.0	8	14.6	14.6	10	50	10	50
1578	RCS #37 - LINE 3c	28.6	0.0	28.6	0.0	8	20.6	20.6	10	50	10	50
1580	RCS #37 - LINE 3c	25.6	0.0	25.6	0.0	8	17.6	17.6	10	50	10	50
1581	RCS #37 - LINE 3c	24.0	0.0	24.0	0.0	8	16.0	16.0	10	50	10	50
1583	RCS #37 - LINE 3c	25.3	0.0	25.3	0.0	8	17.3	17.3	10	50	10	50
1584	RCS #37 - LINE 3c	24.0	0.0	24.0	0.0	8	16.0	16.0	10	50	10	50
1585	RCS #37 - LINE 3c	22.9	0.0	22.9	0.0	8	14.9	14.9	10	50	10	50
1586	RCS #37 - LINE 3c	21.5	0.0	21.5	0.0	8	13.5	13.5	10	50	10	50
1588	RCS #37 - LINE 3c	33.6	0.0	33.7	0.0	8	25.6	25.7	10	50	10	50
1589	RCS #37 - LINE 3c	32.1	0.0	32.2	0.0	8	24.1	24.2	10	50	10	50
1590	RCS #37 - LINE 3c	33.6	0.0	33.7	0.0	8	25.6	25.7	10	50	10	50
1591	RCS #37 - LINE 3c	36.1	0.0	36.1	0.0	8	28.1	28.1	10	50	10	50
1592	RCS #37 - LINE 3c	36.1	0.0	36.1	0.0	8	28.1	28.1	10	50	10	50
1593	RCS #37 - LINE 3c	30.3	0.0	30.3	0.0	8	22.3	22.3	10	50	10	50
1594	RCS #37 - LINE 3c	30.3	0.0	30.1	0.0	8	22.3	22.1	10	50	10	50
1595	RCS #45 - LINE 4	22.9	0.0	22.9	0.0	8	14.9	14.9	10	50	10	50
1596	RCS #45 - LINE 4	22.9	0.0	22.9	0.0	8	14.9	14.9	10	50	10	50
1597	RCS #45 - LINE 4	22.9	0.0	22.9	0.0	8	14.9	14.9	10	50	10	50
1598	RCS #45 - LINE 4	22.9	0.0	22.9	0.0	8	14.9	14.9	10	50	10	50
1599	RCS #45 - LINE 4	22.9	0.0	22.9	0.0	8	14.9	14.9	10	50	10	50
1400	RCS #45 - LINE 4	22.9	0.0	23.0	0.0	8	14.9	15.0	10	50	10	50
1401	RCS #45 - LINE 4	22.9	0.0	23.0	0.0	8	14.9	15.0	10	50	10	50
1402	RCS #45 - LINE 4	22.9	0.0	23.0	0.0	8	14.9	15.0	10	50	10	50
1403	RCS #45 - LINE 4	22.9	0.0	23.0	0.0	8	14.9	15.0	10	50	10	50
1404	RCS #45 - LINE 4	22.9	0.0	23.0	0.0	8	14.9	15.0	10	50	10	50
1405	RCS #45 - LINE 4	27.9	0.0	27.9	0.0	8	19.9	19.9	10	50	10	50
1406	RCS #45 - LINE 4	28.7	0.0	28.9	0.0	8	20.7	20.9	10	50	10	50
1407	RCS #45 - LINE 4	30.5	0.0	31.0	0.0	8	22.5	23.0	10	50	10	50
1408	RCS #45 - LINE 4	30.5	0.0	31.0	0.0	8	22.5	23.0	10	50	10	50
1409	RCS #45 - LINE 4	30.3	0.0	30.9	0.0	8	22.3	22.9	10	50	10	50
1410	RCS #45 - LINE 4	29.0	0.0	29.6	0.0	8	21.0	21.6	10	50	10	50
1411	RCS #45 - LINE 4	25.3	0.0	25.5	0.0	8	17.3	17.5	10	50	10	50
1412	RCS #46 - LINE 5a	31.3	0.0	31.2	0.0	8	23.3	23.2	10	50	10	50
1413	RCS #46 - LINE 5a	31.3	0.0	31.2	0.0	8	23.3	23.2	10	50	10	50
1414	RCS #46 - LINE 5a	31.3	0.0	31.2	0.0	8	23.3	23.2	10	50	10	50
1415	RCS #46 - LINE 5a	31.3	0.0	31.2	0.0	8	23.3	23.2	10	50	10	50
1416	RCS #46 - LINE 5a	22.9	0.0	22.9	0.0	8	14.9	14.9	10	50	10	50
1417	RCS #46 - LINE 5a	22.9	0.0	22.9	0.0	8	14.9	14.9	10	50	10	50
1418	RCS #46 - LINE 5a	22.9	0.0	22.9	0.0	8	14.9	14.9	10	50	10	50
1419	RCS #46 - LINE 5a	32.0	0.0	31.8	0.0	8	24.0	23.8	10	50	10	50
1421	RCS #46 - LINE 5a	22.8	0.0	22.8	0.0	8	14.8	14.8	10	50	10	50
1422	RCS #46 - LINE 5a	25.0	0.0	25.1	0.0	8	17.0	17.1	10	50	10	50



NODE	LABEL	TEMPERATURE RESULTS AND LIMITS												
		G		H		UFP [°C]	G		H		MIN OPER. [°C]	MAX OPER. [°C]	MIN N.OPER [°C]	MAX N.OPER [°C]
		TEMP [°C]	PW [W]	TEMP [°C]	PW [W]		TEMP-UFP [°C]	TEMP-UFP [°C]						
1423	RCS #46 - LINE 5a	25.0	0.0	25.1	0.0	8	17.0	17.1	10	50	10	50		
1424	RCS #46 - LINE 5a	25.0	0.0	25.1	0.0	8	17.0	17.1	10	50	10	50		
1425	RCS #46 - LINE 5a	25.0	0.0	25.1	0.0	8	17.0	17.1	10	50	10	50		
1426	RCS #47 - LINE 5b	34.3	0.0	34.5	0.0	8	26.3	26.5	10	50	10	50		
1427	RCS #47 - LINE 5b	34.2	0.0	34.4	0.0	8	26.2	26.4	10	50	10	50		
1428	RCS #47 - LINE 5b	34.9	0.0	35.1	0.0	8	26.9	27.1	10	50	10	50		
1429	RCS #47 - LINE 5b	34.5	0.0	34.7	0.0	8	26.5	26.7	10	50	10	50		
1430	RCS #47 - LINE 5b	23.2	0.0	23.3	0.0	8	15.2	15.3	10	50	10	50		
1431	RCS #47 - LINE 5b	23.2	0.0	23.3	0.0	8	15.2	15.3	10	50	10	50		
1432	RCS #47 - LINE 5b	29.1	0.0	29.3	0.0	8	21.1	21.3	10	50	10	50		
1433	RCS #47 - LINE 5b	20.9	0.0	21.0	0.0	8	12.9	13.0	10	50	10	50		
1434	RCS #47 - LINE 5b	20.9	0.0	21.0	0.0	8	12.9	13.0	10	50	10	50		
1435	RCS #47 - LINE 5b	20.9	0.0	21.0	0.0	8	12.9	13.0	10	50	10	50		
1437	RCS #47 - LINE 5b	37.1	0.0	37.4	0.0	8	29.1	29.4	10	50	10	50		
1438	RCS #47 - LINE 5b	31.6	0.0	31.9	0.0	8	23.6	23.9	10	50	10	50		
1439	RCS #47 - LINE 5b	31.6	0.0	31.9	0.0	8	23.6	23.9	10	50	10	50		
1440	RCS #47 - LINE 5b	31.6	0.0	32.0	0.0	8	23.6	24.0	10	50	10	50		
1441	RCS #47 - LINE 5b	31.6	0.0	32.0	0.0	8	23.6	24.0	10	50	10	50		
1442	RCS #47 - LINE 5b	28.2	0.0	28.6	0.0	8	20.2	20.6	10	50	10	50		

Note h: Units with dedicated heater control properly sized; their minimum temperature is the analysis temperature without uncertainty. Only on the RCS the uncertainty is applied even when the heater are operating.

Note c.l.: Units with dedicated heater control law

Table 8.4.1-1 HERSCHEL - Units Temperature results: Sizing Case BOL Nominal G and H

NODE	LABEL	TEMPERATURE RESULTS AND LIMITS								
		I		UFP [°C]	I		MIN OPER. [°C]	MAX OPER. [°C]	MIN N.OPER [°C]	MAX N.OPER [°C]
		TEMP [°C]	PW [W]		TEMP-UFP [°C]	TEMP-UFP [°C]				
4	VMC	8.2	0.0	7.4	0.8	-10	50	-20	60	
5	SAS HOUSING +Z	18.6	0.0	8	10.6	-70	80	-80	90	
16	MGA+Z SEPTUM	71.8	0.0	12.4	59.4	-150	150	-150	150	
21	LGA+Z	78.1	0.0	8	70.1	-150	120	-150	120	
41	LGA-Z	-70.8	1.7	8	-78.8	-150	120	-150	120	
45	SAS HOUSING -Z	-31.1	0.0	8	-39.1	-70	80	-80	90	
49	WINDOW SREM	-18.6	0.0	8	-26.6	-10	50	-45	90	
56	AAD HOUSING	48.2	0.0	8	40.2	-70	70	-80	80	
70	TANK1	11.0	0.0	0	11.0h	10	45	10	45	
71	TANK2	11.0	0.0	0	11.0h	10	45	10	45	
81	GYRO D1	58.1	0.0	8	50.1	-15	65	-25	65	
101	RFDN	15.9	11.8	8	7.9	-25	55	-35	65	
122	EPC1 D1	25.9	9.0	8	17.9	-20	60	-30	70	
123	EPC2 D1	-3.0	0.0	8.2	-11.2	-20	60	-30	70	
104	TRANSX1	22.4	23.0	7.6	14.8	-10	45	-20	55	
105	TRANSX2	4.1	10.0	8	-3.9	-10	45	-20	55	
126	TWTA1 D1	37.7	0.0	7.9	29.8	-20	60	-30	70	
127	TWTA2 D1	-1.8	0.0	8.1	-9.9	-20	60	-30	70	
146	TWTA1_HEAD D1	44.9	32.0	7.9	37.0	-20	60	-30	70	
147	TWTA2_HEAD D1	-2.0	0.0	8.1	-10.1	-20	60	-30	70	

NODE	LABEL	TEMPERATURE RESULTS AND LIMITS							
		I	I	UFP	I	MIN OPER.	MAX OPER.	MIN N.OPER	MAX N.OPER
		TEMP	PW		TEMP-UFP				
[°C]	[W]	[°C]	[°C]	[°C]	[°C]	[°C]	[°C]		
130	CRS1_D1	21.0	8.3	7.3	13.7	0	50	-10	60
131	CRS2_D1	21.8	8.3	7.3	14.5	0	50	-10	60
221	PCDU_D1	6.8	63.2	8	-1.2	-10	47	-20	57
222	CDMU_D1	6.4	37.7	8	-1.6	-10	45	-20	55
223	ACC_D1	8.9	32.1	8	0.9	-10	45	-20	55
204	BATT	3.2	0.0	0	3.2h	0	35	0	35
321	FPSPU1_2_D1	-18.9	0.0	0	-18.9h	-15	45	-30	60
323	FPDPU_D1	-12.9	0.0	0	-12.9h	-15	45	-30	60
324	FPBOLC_D1	-13.7	0.0	0	-13.7h	-15	45	-30	60
325	FPMECDEC_D1	-15.5	0.0	0	-15.5h	-15	45	-30	60
401	CCU	-9.0	5.4	0	-9.0h	-10	40	-20	50
424	HSDCU_D1	-19.4	0.0	8	-27.4	-15	45	-35	60
425	HSDPU_D1	-26.3	0.0	8	-34.3	-15	45	-35	60
426	HSFCU_D1	-22.1	0.0	8	-30.1	-15	45	-35	60
521	FHWOV_D1_BASEPLATE	-2.1	0.0	0	-2.1h	5	15	-25	55
522	FHHRV_D1	-8.5	0.0	0	-8.5h	-10	40	-25	55
523	FHICU_D1	-10.7	0.0	0	-10.7h	-25	40	-30	60
524	FHFCU_D1	-9.0	0.0	0	-9.0h	-10	40	-25	55
526	FHWEV_D1	-13.7	0.0	0	-13.7h	0	30	-25	55
507	FHIFV_D1	-13.8	0.0	0	-13.8h	-10	40	-25	55
508	IFV-HRV	-10.3	0.0	0	-10.3h	-10	40	-25	55
509	IFV-WEV	-10.9	0.0	0	-10.9h	-10	40	-25	55
510	WOV-WEV	-11.8	0.0	0	-11.8h	-10	40	-25	55
511	HRV-HRH	-5.6	0.0	0	-5.6h	-10	40	-25	55
621	FHWOH_D1_BASEPLATE	-0.2	0.0	0	-0.2h	5	15	-25	55
622	FHWEH_D1	-1.9	0.0	0	-1.9h	0	30	-25	55
623	FHHRH_D1	-11.6	0.0	0	-11.6h	-10	40	-25	55
624	FHLCU_D1	-7.9	0.0	0	-7.9h	-10	40	-25	55
625	FHLSU_D1	-1.3	0.0	0	-1.3h	10	40	-25	55
606	FHIFH_D1	-0.9	0.0	8	-8.9	-10	40	-25	55
607	IFH-HRH	-4.7	0.0	0	-4.7h	-10	40	-25	55
608	IFH-WEH	-4.6	0.0	0	-4.6h	-10	40	-25	55
609	WEH-WOH	-3.4	0.0	0	-3.4h	-10	40	-25	55
701	RWL1	1.0	0.0	0	1.0h	0	55	-10	65
702	RWL2	3.8	0.0	0	3.8h	0	55	-10	65
703	RWL3	1.0	0.0	0	1.0h	0	55	-10	65
704	RWL4	1.0	0.0	0	1.0h	0	55	-10	65
8133	FCV BODY MAIN	20.2	0.0	0	20.2h	10	60	10	60
8233	FCV BODY MAIN	19.3	0.0	0	19.3h	10	60	10	60
8333	FCV BODY MAIN	13.2	0.0	0	13.2h	10	60	10	60
8433	FCV BODY MAIN	11.0	0.0	0	11.0h	10	60	10	60
8533	FCV BODY MAIN	11.0	0.0	0	11.0h	10	60	10	60
8633	FCV BODY MAIN	17.8	0.0	0	17.8h	10	60	10	60
8134	FCV BODY REDUNDANT	19.8	0.0	0	19.8h	10	60	10	60
8234	FCV BODY REDUNDANT	16.5	0.0	0	16.5h	10	60	10	60
8334	FCV BODY REDUNDANT	11.0	0.0	0	11.0h	10	60	10	60
8434	FCV BODY REDUNDANT	11.0	0.0	0	11.0h	10	60	10	60
8534	FCV BODY REDUNDANT	11.0	0.0	0	11.0h	10	60	10	60
8634	FCV BODY REDUNDANT	14.8	0.0	0	14.8h	10	60	10	60
80029	STR1+X FOOT	-29.1	0.0	0	-29.1h	-20	40	-30	50
81029	STR2+X FOOT	-29.1	0.0	0	-29.1h	-20	40	-30	50
1501	RCS #9 - LINE 1	29.9	0.0	8	21.9	10	50	10	50
1502	RCS #9 - LINE 1	29.9	0.0	8	21.9	10	50	10	50
1503	RCS #9 - LINE 1	29.9	0.0	8	21.9	10	50	10	50

NODE	LABEL	TEMPERATURE RESULTS AND LIMITS							
		I	I	UFP	I	MIN OPER.	MAX OPER.	MIN N.OPER	MAX N.OPER
		TEMP	PW		TEMP-UFP				
[°C]	[W]	[°C]	[°C]	[°C]	[°C]	[°C]	[°C]		
1504	RCS #9 - LINE 1	29.9	0.0	8	21.9	10	50	10	50
1505	RCS #9 - LINE 1	29.9	0.0	8	21.9	10	50	10	50
1506	RCS #9 - LINE 1	22.9	0.0	8	14.9	10	50	10	50
1507	RCS #9 - LINE 1	34.2	0.0	8	26.2	10	50	10	50
1508	RCS #9 - LINE 1	24.8	0.0	8	16.8	10	50	10	50
1509	RCS #9 - LINE 1	21.7	0.0	8	13.7	10	50	10	50
1512	RCS #9 - LINE 1	23.5	0.0	8	15.5	10	50	10	50
1513	RCS #9 - LINE 1	33.5	0.0	8	25.5	10	50	10	50
1514	RCS #9 - LINE 1	28.1	0.0	8	20.1	10	50	10	50
1515	RCS #9 - LINE 1	26.9	0.0	8	18.9	10	50	10	50
1516	RCS #9 - LINE 1	28.8	0.0	8	20.8	10	50	10	50
1517	RCS #9 - LINE 1	28.9	0.0	8	20.9	10	50	10	50
1518	RCS #9 - LINE 1	27.3	0.0	8	19.3	10	50	10	50
1519	RCS #9 - LINE 1	28.1	0.0	8	20.1	10	50	10	50
1520	RCS #9 - LINE 1	25.9	0.0	8	17.9	10	50	10	50
1522	RCS #9 - LINE 1	32.7	0.0	8	24.7	10	50	10	50
1523	RCS #9 - LINE 1	27.0	0.0	8	19.0	10	50	10	50
1524	RCS #11 - LINE 2	27.5	0.0	8	19.5	10	50	10	50
1525	RCS #11 - LINE 2	27.4	0.0	8	19.4	10	50	10	50
1526	RCS #11 - LINE 2	27.7	0.0	8	19.7	10	50	10	50
1527	RCS #11 - LINE 2	27.4	0.0	8	19.4	10	50	10	50
1528	RCS #11 - LINE 2	27.4	0.0	8	19.4	10	50	10	50
1529	RCS #11 - LINE 2	23.1	0.0	8	15.1	10	50	10	50
1530	RCS #11 - LINE 2	23.1	0.0	8	15.1	10	50	10	50
1531	RCS #11 - LINE 2	21.9	0.0	8	13.9	10	50	10	50
1532	RCS #11 - LINE 2	22.8	0.0	8	14.8	10	50	10	50
1533	RCS #11 - LINE 2	32.9	0.0	8	24.9	10	50	10	50
1534	RCS #11 - LINE 2	32.9	0.0	8	24.9	10	50	10	50
1535	RCS #11 - LINE 2	32.9	0.0	8	24.9	10	50	10	50
1536	RCS #11 - LINE 2	32.9	0.0	8	24.9	10	50	10	50
1537	RCS #11 - LINE 2	30.4	0.0	8	22.4	10	50	10	50
1538	RCS #11 - LINE 2	31.3	0.0	8	23.3	10	50	10	50
1539	RCS #11 - LINE 2	27.8	0.0	8	19.8	10	50	10	50
1540	RCS #11 - LINE 2	27.8	0.0	8	19.8	10	50	10	50
1541	RCS #11 - LINE 2	27.2	0.0	8	19.2	10	50	10	50
1542	RCS #11 - LINE 2	29.4	0.0	8	21.4	10	50	10	50
1543	RCS #11 - LINE 2	31.3	0.0	9	22.3	10	50	10	50
1544	RCS #11 - LINE 2	22.8	0.0	8	14.8	10	50	10	50
1545	RCS #11 - LINE 2	22.8	0.0	8	14.8	10	50	10	50
1546	RCS #11 - LINE 2	22.8	0.0	8	14.8	10	50	10	50
1547	RCS #11 - LINE 2	22.8	0.0	8	14.8	10	50	10	50
1548	RCS #11 - LINE 2	30.3	0.0	8	22.3	10	50	10	50
1549	RCS #11 - LINE 2	24.3	0.0	8	16.3	10	50	10	50
1550	RCS #11 - LINE 2	24.3	0.0	8	16.3	10	50	10	50
1551	RCS #35 - LINE 3a	20.9	0.0	8	12.9	10	50	10	50
1552	RCS #35 - LINE 3a	20.9	0.0	8	12.9	10	50	10	50
1553	RCS #35 - LINE 3a	20.9	0.0	8	12.9	10	50	10	50
1554	RCS #35 - LINE 3a	20.9	0.0	8	12.9	10	50	10	50
1555	RCS #35 - LINE 3a	20.9	0.0	8	12.9	10	50	10	50
1556	RCS #35 - LINE 3a	19.7	0.0	8	11.7	10	50	10	50
1557	RCS #35 - LINE 3a	19.7	0.0	8	11.7	10	50	10	50
1558	RCS #35 - LINE 3a	19.7	0.0	8	11.7	10	50	10	50
1559	RCS #35 - LINE 3a	19.7	0.0	8	11.7	10	50	10	50
1560	RCS #35 - LINE 3a	20.6	0.0	8	12.6	10	50	10	50

NODE	LABEL	TEMPERATURE RESULTS AND LIMITS							
		I	I	UFP	I	MIN OPER.	MAX OPER.	MIN N.OPER	MAX N.OPER
		TEMP	PW		TEMP-UFP				
[°C]	[W]	[°C]	[°C]	[°C]	[°C]	[°C]	[°C]		
1561	RCS #35 - LINE 3a	22.5	0.0	8	14.5	10	50	10	50
1562	RCS #35 - LINE 3a	25.8	0.0	8	17.8	10	50	10	50
1563	RCS #35 - LINE 3a	27.9	0.0	8	19.9	10	50	10	50
1564	RCS #35 - LINE 3a	27.9	0.0	8	19.9	10	50	10	50
1565	RCS #35 - LINE 3a	27.5	0.0	8	19.5	10	50	10	50
1566	RCS #35 - LINE 3a	23.7	0.0	8	15.7	10	50	10	50
1567	RCS #35 - LINE 3a	29.3	0.0	8	21.3	10	50	10	50
1450	RCS#48-3b- LF	21.9	0.0	8	13.9	10	50	10	50
1477	RCS#48-3b- LV1	23.2	0.0	8	15.2	10	50	10	50
1482	RCS#48-3b- LV2	19.6	0.0	8	11.6	10	50	10	50
1487	RCS#48-3b- PT	28.2	0.0	8	20.2	10	50	10	50
1568	RCS #37 - LINE 3c	35.5	0.0	8	27.5	10	50	10	50
1569	RCS #37 - LINE 3c	44.5	0.0	8	36.5	10	50	10	50
1570	RCS #37 - LINE 3c	51.3	0.0	8	43.3	10	50	10	50
1571	RCS #37 - LINE 3c	39.8	0.0	8	31.8	10	50	10	50
1572	RCS #37 - LINE 3c	22.8	0.0	8	14.8	10	50	10	50
1573	RCS #37 - LINE 3c	23.3	0.0	8	15.3	10	50	10	50
1574	RCS #37 - LINE 3c	25.2	0.0	8	17.2	10	50	10	50
1576	RCS #37 - LINE 3c	22.1	0.0	8	14.1	10	50	10	50
1578	RCS #37 - LINE 3c	32.5	0.0	8	24.5	10	50	10	50
1580	RCS #37 - LINE 3c	28.7	0.0	8	20.7	10	50	10	50
1581	RCS #37 - LINE 3c	15.7	0.0	8	7.7	10	50	10	50
1583	RCS #37 - LINE 3c	21.8	0.0	8	13.8	10	50	10	50
1584	RCS #37 - LINE 3c	17.8	0.0	8	9.8	10	50	10	50
1585	RCS #37 - LINE 3c	17.7	0.0	8	9.7	10	50	10	50
1586	RCS #37 - LINE 3c	16.1	0.0	8	8.1	10	50	10	50
1588	RCS #37 - LINE 3c	44.1	0.0	8	36.1	10	50	10	50
1589	RCS #37 - LINE 3c	43.3	0.0	8	35.3	10	50	10	50
1590	RCS #37 - LINE 3c	42.3	0.0	8	34.3	10	50	10	50
1591	RCS #37 - LINE 3c	47.1	0.0	8	39.1	10	50	10	50
1592	RCS #37 - LINE 3c	47.1	0.0	8	39.1	10	50	10	50
1593	RCS #37 - LINE 3c	38.5	0.0	8	30.5	10	50	10	50
1594	RCS #37 - LINE 3c	43.8	0.0	8	35.8	10	50	10	50
1595	RCS #45 - LINE 4	21.4	0.0	8	13.4	10	50	10	50
1596	RCS #45 - LINE 4	21.4	0.0	8	13.4	10	50	10	50
1597	RCS #45 - LINE 4	21.4	0.0	8	13.4	10	50	10	50
1598	RCS #45 - LINE 4	21.4	0.0	8	13.4	10	50	10	50
1599	RCS #45 - LINE 4	21.4	0.0	8	13.4	10	50	10	50
1400	RCS #45 - LINE 4	22.0	0.0	8	14.0	10	50	10	50
1401	RCS #45 - LINE 4	22.0	0.0	8	14.0	10	50	10	50
1402	RCS #45 - LINE 4	22.0	0.0	8	14.0	10	50	10	50
1403	RCS #45 - LINE 4	22.0	0.0	8	14.0	10	50	10	50
1404	RCS #45 - LINE 4	22.0	0.0	8	14.0	10	50	10	50
1405	RCS #45 - LINE 4	28.0	0.0	8	20.0	10	50	10	50
1406	RCS #45 - LINE 4	29.4	0.0	8	21.4	10	50	10	50
1407	RCS #45 - LINE 4	29.9	0.0	8	21.9	10	50	10	50
1408	RCS #45 - LINE 4	29.9	0.0	8	21.9	10	50	10	50
1409	RCS #45 - LINE 4	29.2	0.0	8	21.2	10	50	10	50
1410	RCS #45 - LINE 4	27.5	0.0	8	19.5	10	50	10	50
1411	RCS #45 - LINE 4	31.9	0.0	8	23.9	10	50	10	50
1412	RCS #46 - LINE 5a	31.6	0.0	8	23.6	10	50	10	50
1413	RCS #46 - LINE 5a	31.6	0.0	8	23.6	10	50	10	50
1414	RCS #46 - LINE 5a	31.6	0.0	8	23.6	10	50	10	50
1415	RCS #46 - LINE 5a	31.6	0.0	8	23.6	10	50	10	50

NODE	LABEL	TEMPERATURE RESULTS AND LIMITS							
		I	I	UFP	I	MIN OPER.	MAX OPER.	MIN N.OPER	MAX N.OPER
		TEMP	PW		TEMP-UFP				
[°C]	[W]	[°C]	[°C]	[°C]	[°C]	[°C]	[°C]		
1416	RCS #46 - LINE 5a	22.9	0.0	8	14.9	10	50	10	50
1417	RCS #46 - LINE 5a	22.9	0.0	8	14.9	10	50	10	50
1418	RCS #46 - LINE 5a	22.9	0.0	8	14.9	10	50	10	50
1419	RCS #46 - LINE 5a	34.9	0.0	8	26.9	10	50	10	50
1421	RCS #46 - LINE 5a	24.1	0.0	8	16.1	10	50	10	50
1422	RCS #46 - LINE 5a	23.5	0.0	8	15.5	10	50	10	50
1423	RCS #46 - LINE 5a	23.5	0.0	8	15.5	10	50	10	50
1424	RCS #46 - LINE 5a	23.5	0.0	8	15.5	10	50	10	50
1425	RCS #46 - LINE 5a	23.5	0.0	8	15.5	10	50	10	50
1426	RCS #47 - LINE 5b	33.9	0.0	8	25.9	10	50	10	50
1427	RCS #47 - LINE 5b	34.0	0.0	8	26.0	10	50	10	50
1428	RCS #47 - LINE 5b	35.0	0.0	8	27.0	10	50	10	50
1429	RCS #47 - LINE 5b	34.6	0.0	8	26.6	10	50	10	50
1430	RCS #47 - LINE 5b	24.8	0.0	8	16.8	10	50	10	50
1431	RCS #47 - LINE 5b	24.8	0.0	8	16.8	10	50	10	50
1432	RCS #47 - LINE 5b	29.2	0.0	8	21.2	10	50	10	50
1433	RCS #47 - LINE 5b	21.0	0.0	8	13.0	10	50	10	50
1434	RCS #47 - LINE 5b	21.0	0.0	8	13.0	10	50	10	50
1435	RCS #47 - LINE 5b	21.0	0.0	8	13.0	10	50	10	50
1437	RCS #47 - LINE 5b	35.3	0.0	8	27.3	10	50	10	50
1438	RCS #47 - LINE 5b	30.4	0.0	8	22.4	10	50	10	50
1439	RCS #47 - LINE 5b	30.4	0.0	8	22.4	10	50	10	50
1440	RCS #47 - LINE 5b	30.1	0.0	8	22.1	10	50	10	50
1441	RCS #47 - LINE 5b	32.5	0.0	8	24.5	10	50	10	50
1442	RCS #47 - LINE 5b	32.9	0.0	8	24.9	10	50	10	50

Note h: Units with dedicated heater control properly sized; their minimum temperature is the analysis temperature without uncertainty. Only on the RCS the uncertainty is applied even when the heater are operating.

Table 8.4.1-2 HERSCHEL - Units Temperature results: Sizing Case BOL Survival I

NOD E	LABEL	TEMPERATURE RESULTS AND LIMITS																
		A		B		C		UFP [°C]	A		B		C		MIN OPER. [°C]	MAX OPER. [°C]	MIN N.OPER [°C]	MAX N.OPER [°C]
		TEMP [°C]	PW [W]	TEMP [°C]	PW [W]	TEMP [°C]	PW [W]		TEMP +UFP [°C]	TEMP +UFP [°C]	TEMP +UFP [°C]							
4	VMC	39.5	0.0	40.5	0.0	40.5	0.0	7.4	46.9	47.9	47.9	-10	50	-20	60			
5	SAS HOUSING +Z	44.6	0.0	45.3	0.0	45.3	0.0	8	52.6	53.3	53.3	-70	80	-80	90			
16	MGA+Z SEPTUM	130.1	0.6	130.5	0.6	130.4	0.6	12.4	142.5	142.9	142.8	-150	150	-150	150			
21	LGA+Z	87.6	0.0	87.8	0.0	87.8	0.0	8	95.6	95.8	95.8	-150	120	-150	120			
41	LGA-Z	-54.8	0.0	-53.1	0.0	-52.6	0.0	8	-46.8	-45.1	-44.6	-150	120	-150	120			
45	SAS HOUSING -Z	1.4	0.0	3.6	0.0	4.1	0.0	8	9.4	11.6	12.1	-70	80	-80	90			
49	WINDOW SREM	25.8	2.6	28.5	2.6	29.2	2.6	8	33.8	36.5	37.2	-10	50	-45	90			
56	AAD HOUSING	62.3	0.0	62.8	0.0	62.8	0.0	8	70.3	70.8	70.8	-70	70	-80	80			
70	TANK1	32.8	0.0	34.3	0.0	34.5	0.0	8	40.8	42.3	42.5	10	45	10	45			
71	TANK2	30.8	0.0	33.4	0.0	33.3	0.0	8	38.8	41.4	41.3	10	45	10	45			
81	GYRO D1	63.7	0.0	63.3	0.0	63.3	0.0	0	63.7	63.3	63.3	-15	65	-25	65			
101	RFDN	36.9	11.8	37.9	11.8	37.8	11.8	8	44.9	45.9	45.8	-25	55	-35	65			
122	EPC1 D1	43.9	9.0	44.8	9.0	44.7	9.0	8	51.9	52.8	52.7	-20	60	-30	70			
123	EPC2 D1	19.3	0.0	20.3	0.0	20.2	0.0	8.2	27.5	28.5	28.4	-20	60	-30	70			
104	TRANSX1	40.7	21.0	41.8	21.0	41.7	21.0	7.6	48.3	49.4	49.3	-10	50	-20	55			
105	TRANSX2	25.5	10.0	26.6	10.0	26.4	10.0	8	33.5	34.6	34.4	-10	45	-20	55			
126	TWTA1_D1	55.5	0.0	56.3	0.0	56.2	0.0	7.9	63.4	64.2	64.1	-20	60	-30	70			
127	TWTA2_D1	20.8	0.0	21.6	0.0	21.6	0.0	8.1	28.9	29.7	29.7	-20	60	-30	70			
146	TWTA1_HEAD_D1	62.4	32.0	63.2	32.0	63.1	32.0	7.9	70.3	71.1	71.0	-20	60	-30	70			
147	TWTA2_HEAD D1	20.6	0.0	21.4	0.0	21.3	0.0	8.1	28.7	29.5	29.4	-20	60	-30	70			
130	CRS1_D1	41.5	8.3	43.3	8.3	43.0	8.3	7.3	48.8	50.6	50.3	0	50	-10	60			
131	CRS2_D1	42.3	8.3	44.0	8.3	43.7	8.3	7.3	49.6	51.3	51.0	0	50	-10	60			
221	PCDU_D1	28.2	76.5	30.3	76.5	29.9	76.5	8	36.2	38.3	37.9	-10	47	-20	57			
222	CDMU_D1	28.6	37.7	32.5	37.7	31.5	37.7	8	36.6	40.5	39.5	-10	45	-20	55			
223	ACC D1	30.3	32.1	34.5	32.1	33.2	32.1	8	38.3	42.5	41.2	-10	45	-20	55			
204	BATT	11.6	2.3	14.2	2.3	13.7	2.3	8	19.6	22.2	21.7	0	35	0	35			
321	FPSPU1_2 D1	28.9	30.3	33.4	30.3	36.5	30.3	8	36.9	41.4	44.5	-15	45	-30	60			
323	FPDPU_D1	20.4	24.0	26.7	24.0	30.9	24.0	8	28.4	34.7	38.9	-15	45	-30	60			
324	FPBOLC_D1	12.4	6.6	33.6	48.6	19.5	6.6	8	20.4	41.6	27.5	-15	45	-30	60			
325	FPMECDEC_D1	18.4	20.9	25.2	21.6	35.6	65.0	8	26.4	33.2	43.6	-15	45	-30	60			
401	CCU	29.4	5.4	31.2	5.4	31.5	5.4	8	37.4	39.2	39.5	-10	40	-20	50			
424	HSDCU_D1	30.7	37.0	32.2	37.0	32.6	37.0	8	38.7	40.2	40.6	-15	45	-35	60			
425	HSDPU_D1	25.8	15.3	29.7	15.3	31.8	15.3	8	33.8	37.7	39.8	-15	45	-35	60			
426	HSFCU_D1	30.8	42.9	34.7	42.9	36.2	42.9	8	38.8	42.7	44.2	-15	45	-35	60			
521	FHWOV_D1 BASE	9.0	1.5	9.0	1.5	9.0	1.5	0	9.0	9.0	9.0	5	15	-25	55			
522	FHHRV_D1	23.6	66.3	23.2	66.3	23.3	66.3	9	32.6	32.2	32.3	-10	40	-25	55			
523	FHICU_D1	21.4	31.4	20.0	29.0	20.1	29.0	8.3	29.7	28.3	28.4	-25	40	-30	60			
524	FHFCU_D1	18.0	13.0	17.6	13.0	17.7	13.0	8	26.0	25.6	25.7	-10	40	-25	55			
526	FHWEV_D1	16.1	25.7	15.8	25.7	15.8	25.7	8	24.1	23.8	23.8	0	30	-25	55			
507	FHIFV_D1	8.7	0.3	7.5	0.0	7.6	0.0	8	16.7	15.5	15.6	-10	40	-25	55			
508	IFV-HRV	18.8	0.0	18.5	0.0	18.6	0.0	9	27.8	27.5	27.6	-10	40	-25	55			
509	IFV-WEV	18.9	0.0	18.4	0.0	18.5	0.0	9	27.9	27.4	27.5	-10	40	-25	55			
510	WOV-WEV	18.4	0.0	18.2	0.0	18.3	0.0	9	27.4	27.2	27.3	-10	40	-25	55			
511	HRV-HRH	26.1	0.0	24.7	0.0	24.8	0.0	9	35.1	33.7	33.8	-10	40	-25	55			
621	FHWOH_D1 BASE	9.0	1.5	9.0	1.5	9.0	1.5	0	9.0	9.0	9.0	5	15	-25	55			
622	FHWEH_D1	21.6	25.7	20.8	25.7	20.8	25.7	7.8	29.4	28.6	28.6	0	30	-25	55			
623	FHHRH_D1	30.4	66.3	29.4	66.3	29.4	66.3	8.8	39.2	38.2	38.2	-10	40	-25	55			
624	FHLCU_D1	31.9	43.4	27.6	37.6	27.6	37.6	8	39.9	35.6	35.6	-10	40	-25	55			
625	FHLSU_D1	31.6	40.4	28.5	35.8	28.5	35.8	8	39.6	36.5	36.5	10	40	-25	55			
606	FHIFH_D1	19.9	0.3	17.0	0.0	17.1	0.0	8	27.9	25.0	25.1	-10	40	-25	55			
607	IFH-HRH	27.5	0.0	25.8	0.0	25.8	0.0	9	36.5	34.8	34.8	-10	40	-25	55			
608	IFH-WEH	27.7	0.0	25.9	0.0	26.0	0.0	9	36.7	34.9	35.0	-10	40	-25	55			

NOD E	LABEL	TEMPERATURE RESULTS AND LIMITS																
		A		B		C		UFP [°C]	A		B		C		MIN OPER. [°C]	MAX OPER. [°C]	MIN N.OPER [°C]	MAX N.OPER [°C]
		TEMP [°C]	PW [W]	TEMP [°C]	PW [W]	TEMP [°C]	PW [W]		TEMP +UFP [°C]	TEMP +UFP [°C]	TEMP +UFP [°C]							
609	WEH-W0H	27.4	0.0	25.4	0.0	25.4	0.0	9	36.4	34.4	34.4	-10	40	-25	55			
701	RWL1	39.4	16.0	40.1	16.0	40.1	16.0	8	47.4	48.1	48.1	0	55	-10	65			
702	RWL2	37.6	16.0	38.2	16.0	38.3	16.0	8	45.6	46.2	46.3	0	55	-10	65			
703	RWL3	39.2	16.0	39.9	16.0	39.9	16.0	8	47.2	47.9	47.9	0	55	-10	65			
704	RWL4	38.8	16.0	39.4	16.0	39.5	16.0	8	46.8	47.4	47.5	0	55	-10	65			
8133	FCV BODY MAIN	44.3	0.0	45.2	0.0	45.1	0.0	8	52.3	53.2	53.1	10	60	10	60			
8233	FCV BODY MAIN	36.5	0.0	38.5	0.0	38.2	0.0	8	44.5	46.5	46.2	10	60	10	60			
8333	FCV BODY MAIN	36.7	0.0	41.0	0.0	39.7	0.0	8	44.7	49.0	47.7	10	60	10	60			
8433	FCV BODY MAIN	34.7	0.0	35.8	0.0	36.1	0.0	8	42.7	43.8	44.1	10	60	10	60			
8533	FCV BODY MAIN	39.5	0.0	39.7	0.0	39.8	0.0	8	47.5	47.7	47.8	10	60	10	60			
8633	FCV BODY MAIN	42.7	0.0	43.0	0.0	43.1	0.0	8	50.7	51.0	51.1	10	60	10	60			
8134	FCV BODY REDUNDANT	44.1	0.0	45.0	0.0	45.0	0.0	8	52.1	53.0	53.0	10	60	10	60			
8234	FCV BODY REDUNDANT	36.6	0.0	38.6	0.0	38.2	0.0	8	44.6	46.6	46.2	10	60	10	60			
8334	FCV BODY REDUNDANT	36.6	0.0	40.9	0.0	39.6	0.0	8	44.6	48.9	47.6	10	60	10	60			
8434	FCV BODY REDUNDANT	34.8	0.0	35.9	0.0	36.1	0.0	8	42.8	43.9	44.1	10	60	10	60			
8534	FCV BODY REDUNDANT	39.6	0.0	39.9	0.0	40.0	0.0	8	47.6	47.9	48.0	10	60	10	60			
8634	FCV BODY REDUNDANT	42.5	0.0	42.8	0.0	42.9	0.0	8	50.5	50.8	50.9	10	60	10	60			
80029	STR1+X FOOT	6.9	0.0	6.9	0.0	6.9	0.0	0	6.9	6.9	6.9	-20	40	-30	50			
81029	STR2+X FOOT	-5.3	0.0	-5.3	0.0	-5.3	0.0	3.8	-1.5	-1.5	-1.5	-20	40	-30	50			
1501	RCS #9 - LINE 1	38.8	0.0	40.1	0.0	40.1	0.0	8	46.8	48.1	48.1	10	50	10	50			
1502	RCS #9 - LINE 1	38.8	0.0	40.1	0.0	40.1	0.0	8	46.8	48.1	48.1	10	50	10	50			
1503	RCS #9 - LINE 1	38.8	0.0	40.1	0.0	40.1	0.0	8	46.8	48.1	48.1	10	50	10	50			
1504	RCS #9 - LINE 1	38.8	0.0	40.1	0.0	40.1	0.0	8	46.8	48.1	48.1	10	50	10	50			
1505	RCS #9 - LINE 1	38.8	0.0	40.1	0.0	40.1	0.0	8	46.8	48.1	48.1	10	50	10	50			
1506	RCS #9 - LINE 1	35.1	0.0	36.3	0.0	36.3	0.0	8	43.1	44.3	44.3	10	50	10	50			
1507	RCS #9 - LINE 1	39.0	0.0	39.9	0.0	39.9	0.0	8	47.0	47.9	47.9	10	50	10	50			
1508	RCS #9 - LINE 1	38.7	0.0	39.6	0.0	39.6	0.0	8	46.7	47.6	47.6	10	50	10	50			
1509	RCS #9 - LINE 1	35.1	0.0	36.2	0.0	36.3	0.0	8	43.1	44.2	44.3	10	50	10	50			
1512	RCS #9 - LINE 1	35.6	0.0	37.0	0.0	36.9	0.0	8	43.6	45.0	44.9	10	50	10	50			
1513	RCS #9 - LINE 1	39.8	0.0	40.9	0.0	40.8	0.0	8	47.8	48.9	48.8	10	50	10	50			
1514	RCS #9 - LINE 1	38.4	0.0	39.5	0.0	39.4	0.0	8	46.4	47.5	47.4	10	50	10	50			
1515	RCS #9 - LINE 1	38.0	0.0	39.1	0.0	39.1	0.0	8	46.0	47.1	47.1	10	50	10	50			
1516	RCS #9 - LINE 1	38.7	0.0	39.7	0.0	39.7	0.0	8	46.7	47.7	47.7	10	50	10	50			
1517	RCS #9 - LINE 1	39.2	0.0	40.1	0.0	40.1	0.0	8	47.2	48.1	48.1	10	50	10	50			
1518	RCS #9 - LINE 1	41.0	0.0	41.9	0.0	41.9	0.0	8	49.0	49.9	49.9	10	50	10	50			
1519	RCS #9 - LINE 1	44.2	0.0	45.1	0.0	45.0	0.0	8	51.2	51.9	51.8	10	50	10	50			
1520	RCS #9 - LINE 1	38.8	0.0	40.0	0.0	40.0	0.0	8	46.8	48.0	48.0	10	50	10	50			
1522	RCS #9 - LINE 1	41.1	0.0	42.0	0.0	42.0	0.0	8	49.1	50.0	50.0	10	50	10	50			
1523	RCS #9 - LINE 1	42.0	0.0	42.9	0.0	42.8	0.0	8	50.0	50.9	50.8	10	50	10	50			
1524	RCS #11 - LINE 2	34.3	0.0	35.8	0.0	35.7	0.0	8	42.3	43.8	43.7	10	50	10	50			
1525	RCS #11 - LINE 2	34.3	0.0	35.8	0.0	35.7	0.0	8	42.3	43.8	43.7	10	50	10	50			
1526	RCS #11 - LINE 2	35.1	0.0	36.6	0.0	36.5	0.0	8	43.1	44.6	44.5	10	50	10	50			
1527	RCS #11 - LINE 2	34.6	0.0	36.2	0.0	36.1	0.0	8	42.6	44.2	44.1	10	50	10	50			
1528	RCS #11 - LINE 2	34.6	0.0	36.2	0.0	36.1	0.0	8	42.6	44.2	44.1	10	50	10	50			
1529	RCS #11 - LINE 2	30.7	0.0	33.7	0.0	33.3	0.0	8	38.7	41.7	41.3	10	50	10	50			
1530	RCS #11 - LINE 2	30.7	0.0	33.7	0.0	33.3	0.0	8	38.7	41.7	41.3	10	50	10	50			
1531	RCS #11 - LINE 2	30.1	0.0	33.0	0.0	32.7	0.0	8	38.1	41.0	40.7	10	50	10	50			
1532	RCS #11 - LINE 2	30.7	0.0	33.5	0.0	33.3	0.0	8	38.7	41.5	41.3	10	50	10	50			
1533	RCS #11 - LINE 2	34.4	0.0	35.9	0.0	35.8	0.0	8	42.4	43.9	43.8	10	50	10	50			
1534	RCS #11 - LINE 2	34.4	0.0	35.9	0.0	35.8	0.0	8	42.4	43.9	43.8	10	50	10	50			
1535	RCS #11 - LINE 2	34.4	0.0	35.9	0.0	35.8	0.0	8	42.4	43.9	43.8	10	50	10	50			
1536	RCS #11 - LINE 2	34.4	0.0	35.9	0.0	35.8	0.0	8	42.4	43.9	43.8	10	50	10	50			
1537	RCS #11 - LINE 2	33.2	0.0	34.9	0.0	34.7	0.0	8	41.2	42.9	42.7	10	50	10	50			

NOD E	LABEL	TEMPERATURE RESULTS AND LIMITS																
		A		B		C		UFP [°C]	A		B		C		MIN OPER. [°C]	MAX OPER. [°C]	MIN N.OPER [°C]	MAX N.OPER [°C]
		TEMP [°C]	PW [W]	TEMP [°C]	PW [W]	TEMP [°C]	PW [W]		TEMP +UFP [°C]	TEMP +UFP [°C]	TEMP +UFP [°C]							
1538	RCS #11 - LINE 2	31.3	0.0	33.3	0.0	33.0	0.0	8	39.3	41.3	41.0	10	50	10	50			
1539	RCS #11 - LINE 2	23.9	0.0	25.9	0.0	25.6	0.0	8	31.9	33.9	33.6	10	50	10	50			
1540	RCS #11 - LINE 2	23.9	0.0	25.9	0.0	25.6	0.0	8	31.9	33.9	33.6	10	50	10	50			
1541	RCS #11 - LINE 2	24.3	0.0	26.4	0.0	26.1	0.0	8	32.3	34.4	34.1	10	50	10	50			
1542	RCS #11 - LINE 2	30.1	0.0	31.7	0.0	31.5	0.0	8	38.1	39.7	39.5	10	50	10	50			
1543	RCS #11 - LINE 2	36.5	0.0	38.6	0.0	38.2	0.0	9	45.5	47.6	47.2	10	50	10	50			
1544	RCS #11 - LINE 2	29.6	0.0	32.6	0.0	32.2	0.0	8	37.6	40.6	40.2	10	50	10	50			
1545	RCS #11 - LINE 2	29.6	0.0	32.6	0.0	32.2	0.0	8	37.6	40.6	40.2	10	50	10	50			
1546	RCS #11 - LINE 2	29.6	0.0	32.6	0.0	32.2	0.0	8	37.6	40.6	40.2	10	50	10	50			
1547	RCS #11 - LINE 2	29.6	0.0	32.6	0.0	32.2	0.0	8	37.6	40.6	40.2	10	50	10	50			
1548	RCS #11 - LINE 2	31.1	0.0	33.8	0.0	33.7	0.0	8	39.1	41.8	41.7	10	50	10	50			
1549	RCS #11 - LINE 2	31.8	0.0	34.6	0.0	34.3	0.0	8	39.8	42.6	42.3	10	50	10	50			
1550	RCS #11 - LINE 2	31.8	0.0	34.6	0.0	34.3	0.0	8	39.8	42.6	42.3	10	50	10	50			
1551	RCS #35 - LINE 3a	28.7	0.0	33.0	0.0	33.5	0.0	8	36.7	41.0	41.5	10	50	10	50			
1552	RCS #35 - LINE 3a	28.7	0.0	33.0	0.0	33.5	0.0	8	36.7	41.0	41.5	10	50	10	50			
1553	RCS #35 - LINE 3a	28.7	0.0	33.0	0.0	33.5	0.0	8	36.7	41.0	41.5	10	50	10	50			
1554	RCS #35 - LINE 3a	28.7	0.0	33.0	0.0	33.5	0.0	8	36.7	41.0	41.5	10	50	10	50			
1555	RCS #35 - LINE 3a	28.7	0.0	33.0	0.0	33.5	0.0	8	36.7	41.0	41.5	10	50	10	50			
1556	RCS #35 - LINE 3a	26.6	0.0	31.2	0.0	31.8	0.0	8	34.6	39.2	39.8	10	50	10	50			
1557	RCS #35 - LINE 3a	26.6	0.0	31.2	0.0	31.8	0.0	8	34.6	39.2	39.8	10	50	10	50			
1558	RCS #35 - LINE 3a	26.6	0.0	31.2	0.0	31.8	0.0	8	34.6	39.2	39.8	10	50	10	50			
1559	RCS #35 - LINE 3a	26.6	0.0	31.2	0.0	31.8	0.0	8	34.6	39.2	39.8	10	50	10	50			
1560	RCS #35 - LINE 3a	26.6	0.0	31.2	0.0	31.8	0.0	8	34.6	39.2	39.8	10	50	10	50			
1561	RCS #35 - LINE 3a	25.9	0.0	31.1	0.0	30.9	0.0	8	33.9	39.1	38.9	10	50	10	50			
1562	RCS #35 - LINE 3a	24.9	0.0	31.1	0.0	29.7	0.0	8	32.9	39.1	37.7	10	50	10	50			
1563	RCS #35 - LINE 3a	23.4	0.0	30.7	0.0	28.0	0.0	8	31.4	38.7	36.0	10	50	10	50			
1564	RCS #35 - LINE 3a	23.4	0.0	30.7	0.0	28.0	0.0	8	31.4	38.7	36.0	10	50	10	50			
1565	RCS #35 - LINE 3a	24.2	0.0	30.8	0.0	28.6	0.0	8	32.2	38.8	36.6	10	50	10	50			
1566	RCS #35 - LINE 3a	22.4	0.0	30.0	0.0	27.4	0.0	8	30.4	38.0	35.4	10	50	10	50			
1567	RCS #35 - LINE 3a	36.6	0.0	40.9	0.0	39.7	0.0	8	44.6	48.9	47.7	10	50	10	50			
1450	RCS#48-3b- LF	28.1	0.0	28.6	0.0	29.7	0.0	8	36.1	36.6	37.7	10	50	10	50			
1477	RCS#48-3b- LV1	28.4	0.0	29.3	0.0	30.4	0.0	8	36.4	37.3	38.4	10	50	10	50			
1482	RCS#48-3b- LV2	28.5	0.0	29.1	0.0	30.2	0.0	8	36.5	37.1	38.2	10	50	10	50			
1487	RCS#48-3b- PT	24.1	0.0	24.1	0.0	25.2	0.0	8	32.1	32.1	33.2	10	50	10	50			
1568	RCS #37 - LINE 3c	27.2	0.0	30.2	0.0	30.9	0.0	8	35.2	38.2	38.9	10	50	10	50			
1569	RCS #37 - LINE 3c	27.7	0.0	30.4	0.0	31.0	0.0	8	35.7	38.4	39.0	10	50	10	50			
1570	RCS #37 - LINE 3c	29.6	0.0	32.2	0.0	32.7	0.0	8	37.6	40.2	40.7	10	50	10	50			
1571	RCS #37 - LINE 3c	29.6	0.0	32.2	0.0	32.7	0.0	8	37.6	40.2	40.7	10	50	10	50			
1572	RCS #37 - LINE 3c	27.7	0.0	30.4	0.0	31.0	0.0	8	35.7	38.4	39.0	10	50	10	50			
1573	RCS #37 - LINE 3c	26.2	0.0	29.9	0.0	30.9	0.0	8	34.2	37.9	38.9	10	50	10	50			
1574	RCS #37 - LINE 3c	25.9	0.0	29.6	0.0	30.6	0.0	8	33.9	37.6	38.6	10	50	10	50			
1576	RCS #37 - LINE 3c	24.4	0.0	28.4	0.0	29.5	0.0	8	32.4	36.4	37.5	10	50	10	50			
1578	RCS #37 - LINE 3c	26.4	0.0	29.8	0.0	30.7	0.0	8	34.4	37.8	38.7	10	50	10	50			
1580	RCS #37 - LINE 3c	27.2	0.0	30.2	0.0	30.9	0.0	8	35.2	38.2	38.9	10	50	10	50			
1581	RCS #37 - LINE 3c	26.2	0.0	29.6	0.0	30.7	0.0	8	34.2	37.6	38.7	10	50	10	50			
1583	RCS #37 - LINE 3c	25.1	0.0	28.6	0.0	29.7	0.0	8	33.1	36.6	37.7	10	50	10	50			
1584	RCS #37 - LINE 3c	25.8	0.0	29.1	0.0	30.3	0.0	8	33.8	37.1	38.3	10	50	10	50			
1585	RCS #37 - LINE 3c	25.1	0.0	28.6	0.0	29.7	0.0	8	33.1	36.6	37.7	10	50	10	50			
1586	RCS #37 - LINE 3c	24.6	0.0	28.2	0.0	29.3	0.0	8	32.6	36.2	37.3	10	50	10	50			
1588	RCS #37 - LINE 3c	29.3	0.0	31.2	0.0	31.5	0.0	8	37.3	39.2	39.5	10	50	10	50			
1589	RCS #37 - LINE 3c	30.9	0.0	32.8	0.0	33.0	0.0	8	38.9	40.8	41.0	10	50	10	50			
1590	RCS #37 - LINE 3c	27.6	0.0	29.2	0.0	29.5	0.0	8	35.6	37.2	37.5	10	50	10	50			
1591	RCS #37 - LINE 3c	30.2	0.0	31.4	0.0	31.7	0.0	8	38.2	39.4	39.7	10	50	10	50			



NOD E	LABEL	TEMPERATURE RESULTS AND LIMITS													
		A		B		C		UFP [°C]	A		B		C		
		TEMP [°C]	PW [W]	TEMP [°C]	PW [W]	TEMP [°C]	PW [W]		TEMP +UFP [°C]	TEMP +UFP [°C]	TEMP +UFP [°C]	MIN OPER. [°C]	MAX OPER. [°C]	MIN N.OPER [°C]	MAX N.OPER [°C]
1592	RCS #37 - LINE 3c	30.2	0.0	31.4	0.0	31.7	0.0	8	38.2	39.4	39.7	10	50	10	50
1593	RCS #37 - LINE 3c	30.6	0.0	31.8	0.0	32.1	0.0	8	38.6	39.8	40.1	10	50	10	50
1594	RCS #37 - LINE 3c	34.7	0.0	35.9	0.0	36.1	0.0	8	42.7	43.9	44.1	10	50	10	50
1595	RCS #45 - LINE 4	29.3	0.0	31.2	0.0	31.5	0.0	8	37.3	39.2	39.5	10	50	10	50
1596	RCS #45 - LINE 4	29.3	0.0	31.2	0.0	31.5	0.0	8	37.3	39.2	39.5	10	50	10	50
1597	RCS #45 - LINE 4	29.3	0.0	31.2	0.0	31.5	0.0	8	37.3	39.2	39.5	10	50	10	50
1598	RCS #45 - LINE 4	29.3	0.0	31.2	0.0	31.5	0.0	8	37.3	39.2	39.5	10	50	10	50
1599	RCS #45 - LINE 4	29.3	0.0	31.2	0.0	31.5	0.0	8	37.3	39.2	39.5	10	50	10	50
1400	RCS #45 - LINE 4	31.0	0.0	32.8	0.0	33.1	0.0	8	39.0	40.8	41.1	10	50	10	50
1401	RCS #45 - LINE 4	31.0	0.0	32.8	0.0	33.1	0.0	8	39.0	40.8	41.1	10	50	10	50
1402	RCS #45 - LINE 4	31.0	0.0	32.8	0.0	33.1	0.0	8	39.0	40.8	41.1	10	50	10	50
1403	RCS #45 - LINE 4	31.0	0.0	32.8	0.0	33.1	0.0	8	39.0	40.8	41.1	10	50	10	50
1404	RCS #45 - LINE 4	31.0	0.0	32.8	0.0	33.1	0.0	8	39.0	40.8	41.1	10	50	10	50
1405	RCS #45 - LINE 4	29.7	0.0	31.3	0.0	31.5	0.0	8	37.7	39.3	39.5	10	50	10	50
1406	RCS #45 - LINE 4	30.2	0.0	31.4	0.0	31.6	0.0	8	38.2	39.4	39.6	10	50	10	50
1407	RCS #45 - LINE 4	27.9	0.0	28.4	0.0	28.6	0.0	8	35.9	36.4	36.6	10	50	10	50
1408	RCS #45 - LINE 4	27.9	0.0	28.4	0.0	28.6	0.0	8	35.9	36.4	36.6	10	50	10	50
1409	RCS #45 - LINE 4	27.4	0.0	27.7	0.0	27.9	0.0	8	35.4	35.7	35.9	10	50	10	50
1410	RCS #45 - LINE 4	27.4	0.0	27.6	0.0	27.7	0.0	8	35.4	35.6	35.7	10	50	10	50
1411	RCS #45 - LINE 4	39.6	0.0	39.8	0.0	39.9	0.0	8	47.6	47.8	47.9	10	50	10	50
1412	RCS #46 - LINE 5a	33.0	0.0	34.3	0.0	34.4	0.0	8	41.0	42.3	42.4	10	50	10	50
1413	RCS #46 - LINE 5a	33.0	0.0	34.3	0.0	34.4	0.0	8	41.0	42.3	42.4	10	50	10	50
1414	RCS #46 - LINE 5a	33.0	0.0	34.3	0.0	34.4	0.0	8	41.0	42.3	42.4	10	50	10	50
1415	RCS #46 - LINE 5a	33.0	0.0	34.3	0.0	34.4	0.0	8	41.0	42.3	42.4	10	50	10	50
1416	RCS #46 - LINE 5a	35.0	0.0	36.2	0.0	36.4	0.0	8	43.0	44.2	44.4	10	50	10	50
1417	RCS #46 - LINE 5a	35.0	0.0	36.2	0.0	36.4	0.0	8	43.0	44.2	44.4	10	50	10	50
1418	RCS #46 - LINE 5a	35.0	0.0	36.2	0.0	36.4	0.0	8	43.0	44.2	44.4	10	50	10	50
1419	RCS #46 - LINE 5a	33.9	0.0	35.2	0.0	35.4	0.0	8	41.9	43.2	43.4	10	50	10	50
1421	RCS #46 - LINE 5a	32.9	0.0	34.3	0.0	34.5	0.0	8	40.9	42.3	42.5	10	50	10	50
1422	RCS #46 - LINE 5a	33.2	0.0	34.5	0.0	34.6	0.0	8	41.2	42.5	42.6	10	50	10	50
1423	RCS #46 - LINE 5a	33.2	0.0	34.5	0.0	34.6	0.0	8	41.2	42.5	42.6	10	50	10	50
1424	RCS #46 - LINE 5a	33.2	0.0	34.5	0.0	34.6	0.0	8	41.2	42.5	42.6	10	50	10	50
1425	RCS #46 - LINE 5a	33.2	0.0	34.5	0.0	34.6	0.0	8	41.2	42.5	42.6	10	50	10	50
1426	RCS #47 - LINE 5b	34.6	0.0	35.7	0.0	35.8	0.0	8	42.6	43.7	43.8	10	50	10	50
1427	RCS #47 - LINE 5b	34.7	0.0	35.9	0.0	35.9	0.0	8	42.7	43.9	43.9	10	50	10	50
1428	RCS #47 - LINE 5b	35.1	0.0	36.2	0.0	36.3	0.0	8	43.1	44.2	44.3	10	50	10	50
1429	RCS #47 - LINE 5b	35.1	0.0	36.3	0.0	36.3	0.0	8	43.1	44.3	44.3	10	50	10	50
1430	RCS #47 - LINE 5b	37.9	0.0	39.0	0.0	39.0	0.0	8	45.9	47.0	47.0	10	50	10	50
1431	RCS #47 - LINE 5b	37.9	0.0	39.0	0.0	39.0	0.0	8	45.9	47.0	47.0	10	50	10	50
1432	RCS #47 - LINE 5b	35.2	0.0	36.3	0.0	36.3	0.0	8	43.2	44.3	44.3	10	50	10	50
1433	RCS #47 - LINE 5b	35.1	0.0	36.3	0.0	36.3	0.0	8	43.1	44.3	44.3	10	50	10	50
1434	RCS #47 - LINE 5b	35.1	0.0	36.3	0.0	36.3	0.0	8	43.1	44.3	44.3	10	50	10	50
1435	RCS #47 - LINE 5b	35.1	0.0	36.3	0.0	36.3	0.0	8	43.1	44.3	44.3	10	50	10	50
1437	RCS #47 - LINE 5b	34.6	0.0	35.5	0.0	35.6	0.0	8	42.6	43.5	43.6	10	50	10	50
1438	RCS #47 - LINE 5b	33.5	0.0	34.1	0.0	34.1	0.0	8	41.5	42.1	42.1	10	50	10	50
1439	RCS #47 - LINE 5b	33.5	0.0	34.1	0.0	34.1	0.0	8	41.5	42.1	42.1	10	50	10	50
1440	RCS #47 - LINE 5b	32.9	0.0	33.3	0.0	33.3	0.0	8	40.9	41.3	41.3	10	50	10	50
1441	RCS #47 - LINE 5b	36.1	0.0	36.5	0.0	36.5	0.0	8	44.1	44.5	44.5	10	50	10	50
1442	RCS #47 - LINE 5b	42.6	0.0	42.9	0.0	43.0	0.0	8	50.6	50.9	51.0	10	50	10	50

Table 8.4.1-3 HERSCHEL - Units Temperature results: Sizing Case EOL Nominal A, B and C

NODE	LABEL	TEMPERATURE RESULTS AND LIMITS																
		D		E		F		UFP	D		E		F		MIN OPER.	MAX OPER.	MIN N.OPER	MAX N.OPER
		TEMP [°C]	PW [W]	TEMP [°C]	PW [W]	TEMP [°C]	PW [W]		TEMP +UFP [°C]	TEMP +UFP [°C]	TEMP +UFP [°C]	TEMP [°C]	TEMP [°C]	TEMP [°C]				
4	VMC	39.7	0.0	40.6	0.0	40.6	0.0	7.4	47.1	48.0	48.0	-10	50	-20	60			
5	SAS HOUSING +Z	44.3	0.0	45.1	0.0	45.1	0.0	8	52.3	53.1	53.1	-70	80	-80	90			
16	MGA+Z SEPTUM	130.0	0.6	130.4	0.6	130.4	0.6	12.4	142.4	142.8	142.8	-150	150	-150	150			
21	LGA+Z	87.7	0.0	87.8	0.0	87.8	0.0	8	95.7	95.8	95.8	-150	120	-150	120			
41	LGA-Z	-54.8	0.0	-53.1	0.0	-52.6	0.0	8	-46.8	-45.1	-44.6	-150	120	-150	120			
45	SAS HOUSING -Z	1.4	0.0	3.5	0.0	4.1	0.0	8	9.4	11.5	12.1	-70	80	-80	90			
49	WINDOW SREM	25.7	2.6	28.5	2.6	29.2	2.6	8	33.7	36.5	37.2	-10	50	-45	90			
56	AAD HOUSING	62.1	0.0	62.7	0.0	62.6	0.0	8	70.1	70.7	70.6	-70	70	-80	80			
70	TANK1	32.8	0.0	34.3	0.0	34.5	0.0	8	40.8	42.3	42.5	10	45	10	45			
71	TANK2	30.6	0.0	33.3	0.0	33.2	0.0	8	38.6	41.3	41.2	10	45	10	45			
81	GYRO_D1	63.7	0.0	63.3	0.0	63.3	0.0	0	63.7c.l	63.3c.l	63.3c.l	-15	65	-25	65			
101	RFDN	36.4	11.8	37.4	11.8	37.3	11.8	8	44.4	45.4	45.3	-25	55	-35	65			
122	EPC1_D1	43.2	9.0	44.2	9.0	44.1	9.0	8	51.2	52.2	52.1	-20	60	-30	70			
123	EPC2_D1	18.5	0.0	19.5	0.0	19.4	0.0	8.2	26.7	27.7	27.6	-20	60	-30	70			
104	TRANSX1	40.1	21.0	41.2	21.0	41.0	21.0	7.6	47.7	48.8	48.6	-10	50	-20	55			
105	TRANSX2	24.8	10.0	25.9	10.0	25.8	10.0	8	32.8	33.9	33.8	-10	45	-20	55			
126	TWTA1_D1	54.8	0.0	55.6	0.0	55.5	0.0	7.9	62.7	63.5	63.4	-20	60	-30	70			
127	TWTA2_D1	20.1	0.0	20.9	0.0	20.9	0.0	8.1	28.2	29.0	29.0	-20	60	-30	70			
146	TWTA1_HEAD_D1	61.7	32.0	62.5	32.0	62.5	32.0	7.9	69.6	70.4	70.4	-20	60	-30	70			
147	TWTA2_HEAD_D1	19.8	0.0	20.7	0.0	20.6	0.0	8.1	27.9	28.8	28.7	-20	60	-30	70			
130	CRS1_D1	41.2	8.3	42.9	8.3	42.7	8.3	7.3	48.5	50.2	50.0	0	50	-10	60			
131	CRS2_D1	41.9	8.3	43.7	8.3	43.4	8.3	7.3	49.2	51.0	50.7	0	50	-10	60			
221	PCDU_D1	28.0	76.5	30.1	76.5	29.7	76.5	8	36.0	38.1	37.7	-10	47	-20	57			
222	CDMU_D1	28.4	37.7	32.3	37.7	31.3	37.7	8	36.4	40.3	39.3	-10	45	-20	55			
223	ACC_D1	30.2	32.1	34.4	32.1	33.1	32.1	8	38.2	42.4	41.1	-10	45	-20	55			
204	BATT	11.3	2.3	13.9	2.3	13.4	2.3	8	19.3	21.9	21.4	0	35	0	35			
321	FPSPU1_2_D1	28.8	30.3	33.3	30.3	36.5	30.3	8	36.8	41.3	44.5	-15	45	-30	60			
323	FPDPU_D1	20.3	24.0	26.7	24.0	30.8	24.0	8	28.3	34.7	38.8	-15	45	-30	60			
324	FPBOLC_D1	12.3	6.6	33.5	48.6	19.4	6.6	8	20.3	41.5	27.4	-15	45	-30	60			
325	FPMECDEC_D1	18.4	20.9	25.1	21.6	35.6	65.0	8	26.4	33.1	43.6	-15	45	-30	60			
401	CCU	29.4	5.4	31.2	5.4	31.5	5.4	8	37.4	39.2	39.5	-10	40	-20	50			
424	HSDCU_D1	30.7	37.0	32.2	37.0	32.6	37.0	8	38.7	40.2	40.6	-15	45	-35	60			
425	HSDPU_D1	25.7	15.3	29.6	15.3	31.7	15.3	8	33.7	37.6	39.7	-15	45	-35	60			
426	HSFCU_D1	30.8	42.9	34.6	42.9	36.1	42.9	8	38.8	42.6	44.1	-15	45	-35	60			
521	FHWOV_D1 BASE	9.0	1.5	9.0	1.5	9.0	1.5	0	9.0c.l	9.0c.l	9.0c.l	5	15	-25	55			
522	FHHRV_D1	23.7	66.3	23.2	66.3	23.3	66.3	9	32.7	32.2	32.3	-10	40	-25	55			
523	FHICU_D1	21.5	31.4	20.0	29.0	20.1	29.0	8.3	29.8	28.3	28.4	-25	40	-30	60			
524	FHFUCU_D1	18.0	13.0	17.6	13.0	17.7	13.0	8	26.0	25.6	25.7	-10	40	-25	55			
526	FHWEV_D1	16.1	25.7	15.8	25.7	15.9	25.7	8	24.1	23.8	23.9	0	30	-25	55			
507	FHIFV_D1	8.7	0.3	7.5	0.0	7.6	0.0	8	16.7	15.5	15.6	-10	40	-25	55			
508	IFV-HRV	18.8	0.0	18.5	0.0	18.6	0.0	9	27.8	27.5	27.6	-10	40	-25	55			
509	IFV-WEV	18.9	0.0	18.4	0.0	18.5	0.0	9	27.9	27.4	27.5	-10	40	-25	55			
510	WOV-WEV	18.4	0.0	18.2	0.0	18.3	0.0	9	27.4	27.2	27.3	-10	40	-25	55			
511	HRV-HRH	26.1	0.0	24.8	0.0	24.9	0.0	9	35.1	33.8	33.9	-10	40	-25	55			
621	FHWOH_D1 BASE	9.0	1.5	9.0	1.5	9.0	1.5	0	9.0c.l	9.0c.l	9.0c.l	5	15	-25	55			
622	FHWEH_D1	21.7	25.7	21.0	25.7	21.0	25.7	7.8	29.5	28.8	28.8	0	30	-25	55			
623	FHHRH_D1	30.5	66.3	29.5	66.3	29.5	66.3	8.8	39.3	38.3	38.3	-10	40	-25	55			
624	FHLCU_D1	32.0	43.4	27.7	37.6	27.7	37.6	8	40.0	35.7	35.7	-10	40	-25	55			
625	FHLSU_D1	31.7	40.4	28.5	35.8	28.6	35.8	8	39.7	36.5	36.6	10	40	-25	55			
606	FHIFH_D1	20.0	0.3	17.0	0.0	17.1	0.0	8	28.0	25.0	25.1	-10	40	-25	55			
607	IFH-HRH	27.6	0.0	25.9	0.0	25.9	0.0	9	36.6	34.9	34.9	-10	40	-25	55			
608	IFH-WEH	27.8	0.0	26.0	0.0	26.1	0.0	9	36.8	35.0	35.1	-10	40	-25	55			

NODE	LABEL	TEMPERATURE RESULTS AND LIMITS																
		D		E		F		UFP [°C]	D		E		F		MIN OPER. [°C]	MAX OPER. [°C]	MIN N.OPER [°C]	MAX N.OPER [°C]
		TEMP [°C]	PW [W]	TEMP [°C]	PW [W]	TEMP [°C]	PW [W]		TEMP +UFP [°C]	TEMP +UFP [°C]	TEMP +UFP [°C]							
609	WEH-W0H	27.5	0.0	25.5	0.0	25.5	0.0	9	36.5	34.5	34.5	-10	40	-25	55			
701	RWL1	39.7	16.0	40.4	16.0	40.5	16.0	8	47.7	48.4	48.5	0	55	-10	65			
702	RWL2	38.0	16.0	38.6	16.0	38.6	16.0	8	46.0	46.6	46.6	0	55	-10	65			
703	RWL3	39.5	16.0	40.3	16.0	40.3	16.0	8	47.5	48.3	48.3	0	55	-10	65			
704	RWL4	39.2	16.0	39.8	16.0	39.8	16.0	8	47.2	47.8	47.8	0	55	-10	65			
8133	FCV BODY MAIN	44.2	0.0	45.0	0.0	45.0	0.0	8	52.2	53.0	53.0	10	60	10	60			
8233	FCV BODY MAIN	36.3	0.0	38.3	0.0	38.0	0.0	8	44.3	46.3	46.0	10	60	10	60			
8333	FCV BODY MAIN	36.5	0.0	40.8	0.0	39.6	0.0	8	44.5	48.8	47.6	10	60	10	60			
8433	FCV BODY MAIN	34.7	0.0	35.9	0.0	36.1	0.0	8	42.7	43.9	44.1	10	60	10	60			
8533	FCV BODY MAIN	39.6	0.0	39.8	0.0	39.9	0.0	8	47.6	47.8	47.9	10	60	10	60			
8633	FCV BODY MAIN	43.0	0.0	43.3	0.0	43.3	0.0	8	51.0	51.3	51.3	10	60	10	60			
8134	FCV BODY REDUNDANT	44.0	0.0	44.9	0.0	44.8	0.0	8	52.0	52.9	52.8	10	60	10	60			
8234	FCV BODY REDUNDANT	36.3	0.0	38.4	0.0	38.0	0.0	8	44.3	46.4	46.0	10	60	10	60			
8334	FCV BODY REDUNDANT	36.4	0.0	40.8	0.0	39.5	0.0	8	44.4	48.8	47.5	10	60	10	60			
8434	FCV BODY REDUNDANT	34.8	0.0	35.9	0.0	36.2	0.0	8	42.8	43.9	44.2	10	60	10	60			
8534	FCV BODY REDUNDANT	39.7	0.0	40.0	0.0	40.1	0.0	8	47.7	48.0	48.1	10	60	10	60			
8634	FCV BODY REDUNDANT	42.8	0.0	43.1	0.0	43.1	0.0	8	50.8	51.1	51.1	10	60	10	60			
80029	STR1+X FOOT	7.0	0.0	7.0	0.0	7.0	0.0	0	7.0c.l.	7.0c.l.	7.0c.l.	-20	40	-30	50			
81029	STR2+X FOOT	-5.4	0.0	-5.4	0.0	-5.4	0.0	3.8	-1.6	-1.6	-1.6	-20	40	-30	50			
1501	RCS #9 - LINE 1	38.8	0.0	40.0	0.0	40.0	0.0	8	46.8	48.0	48.0	10	50	10	50			
1502	RCS #9 - LINE 1	38.8	0.0	40.0	0.0	40.0	0.0	8	46.8	48.0	48.0	10	50	10	50			
1503	RCS #9 - LINE 1	38.8	0.0	40.0	0.0	40.0	0.0	8	46.8	48.0	48.0	10	50	10	50			
1504	RCS #9 - LINE 1	38.8	0.0	40.0	0.0	40.0	0.0	8	46.8	48.0	48.0	10	50	10	50			
1505	RCS #9 - LINE 1	38.8	0.0	40.0	0.0	40.0	0.0	8	46.8	48.0	48.0	10	50	10	50			
1506	RCS #9 - LINE 1	35.3	0.0	36.4	0.0	36.4	0.0	8	43.3	44.4	44.4	10	50	10	50			
1507	RCS #9 - LINE 1	39.2	0.0	40.1	0.0	40.1	0.0	8	47.2	48.1	48.1	10	50	10	50			
1508	RCS #9 - LINE 1	38.9	0.0	39.8	0.0	39.8	0.0	8	46.9	47.8	47.8	10	50	10	50			
1509	RCS #9 - LINE 1	35.3	0.0	36.4	0.0	36.4	0.0	8	43.3	44.4	44.4	10	50	10	50			
1512	RCS #9 - LINE 1	35.3	0.0	36.7	0.0	36.6	0.0	8	43.3	44.7	44.6	10	50	10	50			
1513	RCS #9 - LINE 1	39.6	0.0	40.7	0.0	40.6	0.0	8	47.6	48.7	48.6	10	50	10	50			
1514	RCS #9 - LINE 1	38.1	0.0	39.2	0.0	39.2	0.0	8	46.1	47.2	47.2	10	50	10	50			
1515	RCS #9 - LINE 1	37.8	0.0	38.9	0.0	38.8	0.0	8	45.8	46.9	46.8	10	50	10	50			
1516	RCS #9 - LINE 1	38.5	0.0	39.5	0.0	39.4	0.0	8	46.5	47.5	47.4	10	50	10	50			
1517	RCS #9 - LINE 1	38.9	0.0	39.8	0.0	39.8	0.0	8	46.9	47.8	47.8	10	50	10	50			
1518	RCS #9 - LINE 1	40.8	0.0	41.7	0.0	41.7	0.0	8	48.8	49.7	49.7	10	50	10	50			
1519	RCS #9 - LINE 1	44.1	0.0	44.9	0.0	44.9	0.0	8	51.4	51.6	51.6	10	50	10	50			
1520	RCS #9 - LINE 1	38.7	0.0	40.0	0.0	40.0	0.0	8	46.7	48.0	48.0	10	50	10	50			
1522	RCS #9 - LINE 1	40.9	0.0	41.8	0.0	41.7	0.0	8	48.9	49.8	49.7	10	50	10	50			
1523	RCS #9 - LINE 1	41.7	0.0	42.6	0.0	42.6	0.0	8	49.7	50.6	50.6	10	50	10	50			
1524	RCS #11 - LINE 2	34.0	0.0	35.5	0.0	35.5	0.0	8	42.0	43.5	43.5	10	50	10	50			
1525	RCS #11 - LINE 2	34.0	0.0	35.5	0.0	35.5	0.0	8	42.0	43.5	43.5	10	50	10	50			
1526	RCS #11 - LINE 2	34.8	0.0	36.4	0.0	36.3	0.0	8	42.8	44.4	44.3	10	50	10	50			
1527	RCS #11 - LINE 2	34.4	0.0	36.0	0.0	35.9	0.0	8	42.4	44.0	43.9	10	50	10	50			
1528	RCS #11 - LINE 2	34.4	0.0	36.0	0.0	35.9	0.0	8	42.4	44.0	43.9	10	50	10	50			
1529	RCS #11 - LINE 2	30.6	0.0	33.5	0.0	33.2	0.0	8	38.6	41.5	41.2	10	50	10	50			
1530	RCS #11 - LINE 2	30.6	0.0	33.5	0.0	33.2	0.0	8	38.6	41.5	41.2	10	50	10	50			
1531	RCS #11 - LINE 2	29.9	0.0	32.9	0.0	32.5	0.0	8	37.9	40.9	40.5	10	50	10	50			
1532	RCS #11 - LINE 2	30.6	0.0	33.3	0.0	33.2	0.0	8	38.6	41.3	41.2	10	50	10	50			
1533	RCS #11 - LINE 2	34.1	0.0	35.6	0.0	35.6	0.0	8	42.1	43.6	43.6	10	50	10	50			
1534	RCS #11 - LINE 2	34.1	0.0	35.6	0.0	35.6	0.0	8	42.1	43.6	43.6	10	50	10	50			
1535	RCS #11 - LINE 2	34.1	0.0	35.6	0.0	35.6	0.0	8	42.1	43.6	43.6	10	50	10	50			
1536	RCS #11 - LINE 2	34.1	0.0	35.6	0.0	35.6	0.0	8	42.1	43.6	43.6	10	50	10	50			
1537	RCS #11 - LINE 2	32.9	0.0	34.6	0.0	34.4	0.0	8	40.9	42.6	42.4	10	50	10	50			

NODE	LABEL	TEMPERATURE RESULTS AND LIMITS																
		D		E		F		UFP [°C]	D		E		F		MIN OPER. [°C]	MAX OPER. [°C]	MIN N.OPER [°C]	MAX N.OPER [°C]
		TEMP [°C]	PW [W]	TEMP [°C]	PW [W]	TEMP [°C]	PW [W]		TEMP +UFP [°C]	TEMP +UFP [°C]	TEMP +UFP [°C]							
1538	RCS #11 - LINE 2	30.9	0.0	33.0	0.0	32.7	0.0	8	38.9	41.0	40.7	10	50	10	50			
1539	RCS #11 - LINE 2	23.6	0.0	25.6	0.0	25.2	0.0	8	31.6	33.6	33.2	10	50	10	50			
1540	RCS #11 - LINE 2	23.6	0.0	25.6	0.0	25.2	0.0	8	31.6	33.6	33.2	10	50	10	50			
1541	RCS #11 - LINE 2	24.0	0.0	26.1	0.0	25.7	0.0	8	32.0	34.1	33.7	10	50	10	50			
1542	RCS #11 - LINE 2	29.7	0.0	31.3	0.0	31.1	0.0	8	37.7	39.3	39.1	10	50	10	50			
1543	RCS #11 - LINE 2	36.3	0.0	38.3	0.0	38.0	0.0	9	45.3	47.3	47.0	10	50	10	50			
1544	RCS #11 - LINE 2	29.5	0.0	32.4	0.0	32.1	0.0	8	37.5	40.4	40.1	10	50	10	50			
1545	RCS #11 - LINE 2	29.5	0.0	32.4	0.0	32.1	0.0	8	37.5	40.4	40.1	10	50	10	50			
1546	RCS #11 - LINE 2	29.5	0.0	32.4	0.0	32.1	0.0	8	37.5	40.4	40.1	10	50	10	50			
1547	RCS #11 - LINE 2	29.5	0.0	32.4	0.0	32.1	0.0	8	37.5	40.4	40.1	10	50	10	50			
1548	RCS #11 - LINE 2	31.0	0.0	33.7	0.0	33.5	0.0	8	39.0	41.7	41.5	10	50	10	50			
1549	RCS #11 - LINE 2	31.6	0.0	34.4	0.0	34.1	0.0	8	39.6	42.4	42.1	10	50	10	50			
1550	RCS #11 - LINE 2	31.6	0.0	34.4	0.0	34.1	0.0	8	39.6	42.4	42.1	10	50	10	50			
1551	RCS #35 - LINE 3a	28.6	0.0	32.9	0.0	33.4	0.0	8	36.6	40.9	41.4	10	50	10	50			
1552	RCS #35 - LINE 3a	28.6	0.0	32.9	0.0	33.4	0.0	8	36.6	40.9	41.4	10	50	10	50			
1553	RCS #35 - LINE 3a	28.6	0.0	32.9	0.0	33.4	0.0	8	36.6	40.9	41.4	10	50	10	50			
1554	RCS #35 - LINE 3a	28.6	0.0	32.9	0.0	33.4	0.0	8	36.6	40.9	41.4	10	50	10	50			
1555	RCS #35 - LINE 3a	28.6	0.0	32.9	0.0	33.4	0.0	8	36.6	40.9	41.4	10	50	10	50			
1556	RCS #35 - LINE 3a	26.6	0.0	31.1	0.0	31.8	0.0	8	34.6	39.1	39.8	10	50	10	50			
1557	RCS #35 - LINE 3a	26.6	0.0	31.1	0.0	31.8	0.0	8	34.6	39.1	39.8	10	50	10	50			
1558	RCS #35 - LINE 3a	26.6	0.0	31.1	0.0	31.8	0.0	8	34.6	39.1	39.8	10	50	10	50			
1559	RCS #35 - LINE 3a	26.6	0.0	31.1	0.0	31.8	0.0	8	34.6	39.1	39.8	10	50	10	50			
1560	RCS #35 - LINE 3a	26.6	0.0	31.1	0.0	31.8	0.0	8	34.6	39.1	39.8	10	50	10	50			
1561	RCS #35 - LINE 3a	25.8	0.0	31.0	0.0	30.8	0.0	8	33.8	39.0	38.8	10	50	10	50			
1562	RCS #35 - LINE 3a	24.7	0.0	30.9	0.0	29.6	0.0	8	32.7	38.9	37.6	10	50	10	50			
1563	RCS #35 - LINE 3a	23.3	0.0	30.6	0.0	27.8	0.0	8	31.3	38.6	35.8	10	50	10	50			
1564	RCS #35 - LINE 3a	23.3	0.0	30.6	0.0	27.8	0.0	8	31.3	38.6	35.8	10	50	10	50			
1565	RCS #35 - LINE 3a	24.0	0.0	30.6	0.0	28.5	0.0	8	32.0	38.6	36.5	10	50	10	50			
1566	RCS #35 - LINE 3a	22.3	0.0	29.9	0.0	27.3	0.0	8	30.3	37.9	35.3	10	50	10	50			
1567	RCS #35 - LINE 3a	36.5	0.0	40.8	0.0	39.6	0.0	8	44.5	48.8	47.6	10	50	10	50			
1450	RCS#48-3b- LF	28.0	0.0	28.5	0.0	29.6	0.0	8	36.0	36.5	37.6	10	50	10	50			
1477	RCS#48-3b- LV1	28.3	0.0	29.3	0.0	30.4	0.0	8	36.3	37.3	38.4	10	50	10	50			
1482	RCS#48-3b- LV2	28.5	0.0	29.0	0.0	30.2	0.0	8	36.5	37.0	38.2	10	50	10	50			
1487	RCS#48-3b- PT	24.1	0.0	24.1	0.0	25.2	0.0	8	32.1	32.1	33.2	10	50	10	50			
1568	RCS #37 - LINE 3c	27.1	0.0	30.1	0.0	30.8	0.0	8	35.1	38.1	38.8	10	50	10	50			
1569	RCS #37 - LINE 3c	27.7	0.0	30.4	0.0	30.9	0.0	8	35.7	38.4	38.9	10	50	10	50			
1570	RCS #37 - LINE 3c	29.5	0.0	32.2	0.0	32.6	0.0	8	37.5	40.2	40.6	10	50	10	50			
1571	RCS #37 - LINE 3c	29.5	0.0	32.2	0.0	32.6	0.0	8	37.5	40.2	40.6	10	50	10	50			
1572	RCS #37 - LINE 3c	27.7	0.0	30.4	0.0	30.9	0.0	8	35.7	38.4	38.9	10	50	10	50			
1573	RCS #37 - LINE 3c	26.2	0.0	29.9	0.0	30.8	0.0	8	34.2	37.9	38.8	10	50	10	50			
1574	RCS #37 - LINE 3c	25.9	0.0	29.5	0.0	30.6	0.0	8	33.9	37.5	38.6	10	50	10	50			
1576	RCS #37 - LINE 3c	24.4	0.0	28.3	0.0	29.5	0.0	8	32.4	36.3	37.5	10	50	10	50			
1578	RCS #37 - LINE 3c	26.4	0.0	29.7	0.0	30.6	0.0	8	34.4	37.7	38.6	10	50	10	50			
1580	RCS #37 - LINE 3c	27.2	0.0	30.2	0.0	30.9	0.0	8	35.2	38.2	38.9	10	50	10	50			
1581	RCS #37 - LINE 3c	26.2	0.0	29.6	0.0	30.7	0.0	8	34.2	37.6	38.7	10	50	10	50			
1583	RCS #37 - LINE 3c	25.0	0.0	28.5	0.0	29.7	0.0	8	33.0	36.5	37.7	10	50	10	50			
1584	RCS #37 - LINE 3c	25.7	0.0	29.1	0.0	30.2	0.0	8	33.7	37.1	38.2	10	50	10	50			
1585	RCS #37 - LINE 3c	25.0	0.0	28.5	0.0	29.7	0.0	8	33.0	36.5	37.7	10	50	10	50			
1586	RCS #37 - LINE 3c	24.5	0.0	28.2	0.0	29.3	0.0	8	32.5	36.2	37.3	10	50	10	50			
1588	RCS #37 - LINE 3c	29.3	0.0	31.2	0.0	31.5	0.0	8	37.3	39.2	39.5	10	50	10	50			
1589	RCS #37 - LINE 3c	30.9	0.0	32.8	0.0	33.1	0.0	8	38.9	40.8	41.1	10	50	10	50			
1590	RCS #37 - LINE 3c	27.7	0.0	29.2	0.0	29.5	0.0	8	35.7	37.2	37.5	10	50	10	50			
1591	RCS #37 - LINE 3c	30.2	0.0	31.4	0.0	31.7	0.0	8	38.2	39.4	39.7	10	50	10	50			

NODE	LABEL	TEMPERATURE RESULTS AND LIMITS																
		D		E		F		UFP [°C]	D		E		F		MIN OPER. [°C]	MAX OPER. [°C]	MIN N.OPER [°C]	MAX N.OPER [°C]
		TEMP [°C]	PW [W]	TEMP [°C]	PW [W]	TEMP [°C]	PW [W]		TEMP +UFP [°C]	TEMP +UFP [°C]	TEMP +UFP [°C]							
1592	RCS #37 - LINE 3c	30.2	0.0	31.4	0.0	31.7	0.0	8	38.2	39.4	39.7	10	50	10	50			
1593	RCS #37 - LINE 3c	30.6	0.0	31.8	0.0	32.1	0.0	8	38.6	39.8	40.1	10	50	10	50			
1594	RCS #37 - LINE 3c	34.8	0.0	35.9	0.0	36.1	0.0	8	42.8	43.9	44.1	10	50	10	50			
1595	RCS #45 - LINE 4	29.3	0.0	31.2	0.0	31.5	0.0	8	37.3	39.2	39.5	10	50	10	50			
1596	RCS #45 - LINE 4	29.3	0.0	31.2	0.0	31.5	0.0	8	37.3	39.2	39.5	10	50	10	50			
1597	RCS #45 - LINE 4	29.3	0.0	31.2	0.0	31.5	0.0	8	37.3	39.2	39.5	10	50	10	50			
1598	RCS #45 - LINE 4	29.3	0.0	31.2	0.0	31.5	0.0	8	37.3	39.2	39.5	10	50	10	50			
1599	RCS #45 - LINE 4	29.3	0.0	31.2	0.0	31.5	0.0	8	37.3	39.2	39.5	10	50	10	50			
1400	RCS #45 - LINE 4	31.0	0.0	32.8	0.0	33.1	0.0	8	39.0	40.8	41.1	10	50	10	50			
1401	RCS #45 - LINE 4	31.0	0.0	32.8	0.0	33.1	0.0	8	39.0	40.8	41.1	10	50	10	50			
1402	RCS #45 - LINE 4	31.0	0.0	32.8	0.0	33.1	0.0	8	39.0	40.8	41.1	10	50	10	50			
1403	RCS #45 - LINE 4	31.0	0.0	32.8	0.0	33.1	0.0	8	39.0	40.8	41.1	10	50	10	50			
1404	RCS #45 - LINE 4	31.0	0.0	32.8	0.0	33.1	0.0	8	39.0	40.8	41.1	10	50	10	50			
1405	RCS #45 - LINE 4	29.7	0.0	31.3	0.0	31.6	0.0	8	37.7	39.3	39.6	10	50	10	50			
1406	RCS #45 - LINE 4	30.3	0.0	31.4	0.0	31.6	0.0	8	38.3	39.4	39.6	10	50	10	50			
1407	RCS #45 - LINE 4	27.9	0.0	28.5	0.0	28.7	0.0	8	35.9	36.5	36.7	10	50	10	50			
1408	RCS #45 - LINE 4	27.9	0.0	28.5	0.0	28.7	0.0	8	35.9	36.5	36.7	10	50	10	50			
1409	RCS #45 - LINE 4	27.5	0.0	27.8	0.0	28.0	0.0	8	35.5	35.8	36.0	10	50	10	50			
1410	RCS #45 - LINE 4	27.4	0.0	27.6	0.0	27.8	0.0	8	35.4	35.6	35.8	10	50	10	50			
1411	RCS #45 - LINE 4	39.7	0.0	39.9	0.0	40.0	0.0	8	47.7	47.9	48.0	10	50	10	50			
1412	RCS #46 - LINE 5a	33.1	0.0	34.3	0.0	34.5	0.0	8	41.1	42.3	42.5	10	50	10	50			
1413	RCS #46 - LINE 5a	33.1	0.0	34.3	0.0	34.5	0.0	8	41.1	42.3	42.5	10	50	10	50			
1414	RCS #46 - LINE 5a	33.1	0.0	34.3	0.0	34.5	0.0	8	41.1	42.3	42.5	10	50	10	50			
1415	RCS #46 - LINE 5a	33.1	0.0	34.3	0.0	34.5	0.0	8	41.1	42.3	42.5	10	50	10	50			
1416	RCS #46 - LINE 5a	35.1	0.0	36.3	0.0	36.4	0.0	8	43.1	44.3	44.4	10	50	10	50			
1417	RCS #46 - LINE 5a	35.1	0.0	36.3	0.0	36.4	0.0	8	43.1	44.3	44.4	10	50	10	50			
1418	RCS #46 - LINE 5a	35.1	0.0	36.3	0.0	36.4	0.0	8	43.1	44.3	44.4	10	50	10	50			
1419	RCS #46 - LINE 5a	33.9	0.0	35.3	0.0	35.4	0.0	8	41.9	43.3	43.4	10	50	10	50			
1421	RCS #46 - LINE 5a	33.0	0.0	34.4	0.0	34.5	0.0	8	41.0	42.4	42.5	10	50	10	50			
1422	RCS #46 - LINE 5a	33.3	0.0	34.5	0.0	34.7	0.0	8	41.3	42.5	42.7	10	50	10	50			
1423	RCS #46 - LINE 5a	33.3	0.0	34.5	0.0	34.7	0.0	8	41.3	42.5	42.7	10	50	10	50			
1424	RCS #46 - LINE 5a	33.3	0.0	34.5	0.0	34.7	0.0	8	41.3	42.5	42.7	10	50	10	50			
1425	RCS #46 - LINE 5a	33.3	0.0	34.5	0.0	34.7	0.0	8	41.3	42.5	42.7	10	50	10	50			
1426	RCS #47 - LINE 5b	34.7	0.0	35.9	0.0	35.9	0.0	8	42.7	43.9	43.9	10	50	10	50			
1427	RCS #47 - LINE 5b	34.9	0.0	36.0	0.0	36.0	0.0	8	42.9	44.0	44.0	10	50	10	50			
1428	RCS #47 - LINE 5b	35.3	0.0	36.4	0.0	36.4	0.0	8	43.3	44.4	44.4	10	50	10	50			
1429	RCS #47 - LINE 5b	35.3	0.0	36.4	0.0	36.5	0.0	8	43.3	44.4	44.5	10	50	10	50			
1430	RCS #47 - LINE 5b	38.0	0.0	39.1	0.0	39.2	0.0	8	46.0	47.1	47.2	10	50	10	50			
1431	RCS #47 - LINE 5b	38.0	0.0	39.1	0.0	39.2	0.0	8	46.0	47.1	47.2	10	50	10	50			
1432	RCS #47 - LINE 5b	35.3	0.0	36.4	0.0	36.5	0.0	8	43.3	44.4	44.5	10	50	10	50			
1433	RCS #47 - LINE 5b	35.3	0.0	36.4	0.0	36.5	0.0	8	43.3	44.4	44.5	10	50	10	50			
1434	RCS #47 - LINE 5b	35.3	0.0	36.4	0.0	36.5	0.0	8	43.3	44.4	44.5	10	50	10	50			
1435	RCS #47 - LINE 5b	35.3	0.0	36.4	0.0	36.5	0.0	8	43.3	44.4	44.5	10	50	10	50			
1437	RCS #47 - LINE 5b	34.8	0.0	35.7	0.0	35.8	0.0	8	42.8	43.7	43.8	10	50	10	50			
1438	RCS #47 - LINE 5b	33.8	0.0	34.4	0.0	34.4	0.0	8	41.8	42.4	42.4	10	50	10	50			
1439	RCS #47 - LINE 5b	33.8	0.0	34.4	0.0	34.4	0.0	8	41.8	42.4	42.4	10	50	10	50			
1440	RCS #47 - LINE 5b	33.1	0.0	33.6	0.0	33.6	0.0	8	41.1	41.6	41.6	10	50	10	50			
1441	RCS #47 - LINE 5b	36.4	0.0	36.8	0.0	36.8	0.0	8	44.4	44.8	44.8	10	50	10	50			
1442	RCS #47 - LINE 5b	42.9	0.0	43.2	0.0	43.2	0.0	8	50.9	51.2	51.2	10	50	10	50			

Table 8.4.1-4 HERSCHEL - Units Temperature results: Sizing Case EOL Nominal D, E and F

#### 8.4.2 Transient Cases with Attitude Change Results

Transient analysis cases were run to assess the thermal behaviour of the SVM when subjected to attitude change (sun from +30 deg to -30 deg on -X side and vice-versa). Main purpose was to verify the capability of the design to meet the stability requirements. Considerations about the stability are reported in [AD23]. Purpose of this paragraph is to report the temperature level reach from the units during the attitude change in terms of minimum and maximum temperature (Table 8.4.2-1). A complete vision of the results is reported in [AD24].

NODE	LABEL	P		Q	
		T MIN [°C]	T MAX [°C]	T MIN [°C]	T MAX [°C]
4	VMC	6.68	24.67	18.14	39.55
5	SAS HOUSING +Z	20.19	34.37	27.94	44.23
16	MGA+Z SEPTUM	65.55	121.41	73.32	129.99
21	LGA+Z	57.17	80.03	63.75	87.67
41	LGA-Z	-64.15	-57.59	-62.94	-54.96
45	SAS HOUSING -Z	-15.77	-3.46	-13.67	1.2
49	WINDOW SREM	5.12	19.66	7.69	25.49
56	AAD HOUSING	46.54	55.19	51.63	62.04
70	TANK1	11	22.34	12.06	32.5
71	TANK2	11.97	21.48	11.58	30.16
81	GYRO D1	62.44	63.05	62.43	63.07
101	RFDN	2.1	24.89	11.47	36.21
122	EPC1 D1	5.17	32.26	12.87	43.08
123	EPC2 D1	-10.67	4.11	2.07	18.35
104	TRANSX1	10.96	28.53	19.47	39.95
105	TRANSX2	-2.86	11.37	8.49	24.56
126	TWTA1 D1	6.62	44.18	16.24	54.68
127	TWTA2 D1	-10.83	5.75	1.91	19.97
146	TWTA1 HEAD D1	7.15	51.27	16.81	61.63
147	TWTA2 HEAD D1	-11.1	5.49	1.69	19.71
130	CRS1 D1	17.24	32.02	23.05	40.9
131	CRS2 D1	17.83	32.84	23.63	41.67
221	PCDU D1	9.96	20.56	14.05	27.61
222	CDMU D1	9.35	22.38	11.96	28.11
223	ACC D1	11.77	23.97	14.68	29.91
204	BATT	1	4	1.01	8.79
321	FPSPU1_2 D1	12.82	24.24	14.66	28.61
323	FPDPU D1	4.27	15.67	6.18	20.15
324	FPBOLC D1	-6.62	6.65	-4.24	12.1
325	FPMECDEC D1	0.71	13.16	2.86	18.16
401	CCU	7.94	23.42	10.49	29.28
424	HSDCU D1	11.83	25.12	14.29	30.56

NODE	LABEL	P		Q	
		T MIN [°C]	T MAX [°C]	T MIN [°C]	T MAX [°C]
425	HSDPU_D1	9.93	21.06	11.84	25.55
426	HSFCU_D1	13.01	25.68	15.1	30.56
521	FHWOV_D1_BASE	8.5	10.07	8.99	10.01
522	FHHRV_D1	16.94	21.66	17.71	23.6
523	FHICU_D1	14.24	19.43	15.06	21.4
524	FHFCU_D1	10.68	15.67	11.56	17.95
526	FHWEV_D1	10.49	14.31	11.2	16.05
507	FHIFV_D1	6.96	7.47	6.97	8.64
508	IFV-HRV	10.75	16.34	11.73	18.77
509	IFV-WEV	11.02	16.52	11.96	18.85
510	WOV-WEV	9.26	15.67	10.34	18.29
511	HRV-HRH	14.3	22.17	16.35	26.05
621	FHWOH_D1_BASE	8.99	10.32	8.98	10.49
622	FHWEH_D1	10.51	17.24	13.56	21.69
623	FHHRH_D1	21.09	26.55	23.74	30.45
624	FHLCU_D1	22.54	28.78	24.25	31.9
625	FHLSU_D1	22.91	28.47	24.8	31.67
606	FHIFH_D1	10.1	16.81	11.65	19.89
607	IFH-HRH	14.98	23.31	17.39	27.53
608	IFH-WEH	15.23	23.42	17.75	27.71
609	WEH-WOH	16.55	23.5	18.97	27.44
701	RWL1	1.07	15.88	22.77	39.6
702	RWL2	1	15.12	20.58	37.85
703	RWL3	1	15.86	21.65	39.41
704	RWL4	1.59	16.18	22.3	39.06
8133	FCV BODY MAIN	14.11	34.38	20.61	44.04
8233	FCV BODY MAIN	11.01	28.02	13.72	35.74
8333	FCV BODY MAIN	11.01	30.64	11.01	36.24
8433	FCV BODY MAIN	11.01	29.74	11.03	34.62
8533	FCV BODY MAIN	11.47	32.29	15.07	39.47
8633	FCV BODY MAIN	12.2	29.23	22.04	42.87
8134	FCV BODY REDUNDANT	14.12	34.2	20.62	43.86
8234	FCV BODY REDUNDANT	11	28.08	14.2	35.81
8334	FCV BODY REDUNDANT	11.01	30.56	11.1	36.15
8434	FCV BODY REDUNDANT	11.02	29.78	11.01	34.66
8534	FCV BODY REDUNDANT	11.78	32.42	15.41	39.62
8634	FCV BODY REDUNDANT	11.87	29.14	21.65	42.69
80029	STR1+X FOOT	5.41	6.73	5.42	7.2
81029	STR2+X FOOT	-6.92	-5.6	-6.91	-5.15

Table 8.4.2-1 HERSCHEL – Transient cases: Min and Max temperatures (without uncertainty)





HEATER LINE	TCS ID	INSTALLED POWER [ W ]	HEATER POWER [ W ]									
			A	B	C	D	E	F	G	H	I	
			EOL	EOL	EOL	EOL	EOL	EOL	BOL	BOL	BOL Surv.	
TCS Line 18	HTR603S	39.00	0	0	0	0	0	0	0	0	0	38.98
TCS Line 19	HTR604S	20.90	0	0	0	0	0	0	0	0	0	20.9
TCS Line 20	HTR605S	29.00	0	0	0	0	0	0	0	0	0	29
TCS Line 09	HTR1523NS	5.57	0	0	0	0	0	0	0	4.7	4.66	4.7
TCS Line 11	HTR1562NS	6.13	0	0	0	0	0	0	0	5.52	5.48	6.13
TCS Line 35	HTR1544NS	5.27	0	0	0	0	0	0	0	4.1	4.07	5.27
TCS Line 48	HTR1550NS	4.90	0.39	0	0	0.39	0	0	0	2.78	2.75	4.9
TCS Line 37	HTR1554NS	9.92	0	0	0	0	0	0	0	6.09	6.03	9.91
TCS Line 45	HTR1513NS	5.7	0	0	0	0	0	0	0	4.28	4.21	5.72
TCS Line 46	HTR1506NS	4.68	0	0	0	0	0	0	0	3.9	3.82	4.64
TCS Line 47	HTR1535NS	4.82	0	0	0	0	0	0	0	4.54	4.54	4.54
	Total	622	23.5	24.6	24.5	23.6	24.6	24.5	150.3	144.0	483.7	

Table 8.4.3-1 HERSCHEL – Average Heater Power Consumption in Nominal Cases

#### 8.4.4 Redundancy Analysis

A series of additional analysis has been performed to verify the temperature behaviour when the redundancy units are activated. In particular the following hot case analyses have been considered:

##### Transient analysis

- B rid: TT &C activation of line 2 on the hottest case for TT&C and activation of STR2
- C 2 STR ON: two Star Tracker ON on the hottest case for STR to size the Radiator area

The transient case results obtained are showed in Table 8.4.4-1:

NODE	LABEL	TEMPERATURE RESULTS AND LIMITS										
		Brid	Brid	C 2STR ON	C 2STR ON	UFP [°C]	Brid	C 2STR ON	MIN OPER. [°C]	MAX OPER. [°C]	MIN N.OPER [°C]	MAX N.OPER [°C]
		TEMP [°C]	PW [W]	TEMP [°C]	PW [W]		TEMP-UFP [°C]	TEMP-UFP [°C]				
4	VMC	40.4	0.0	40.5	0.0	7.4	47.8	47.9	-10	50	-20	60
5	SAS HOUSING +Z	46.0	0.0	45.3	0.0	8	54.0	53.3	-70	80	-80	90
16	MGA+Z SEPTUM	129.8	0.6	130.5	0.6	12.4	142.2	142.9	-150	150	-150	150
21	LGA+Z	87.7	0.0	87.8	0.0	8	95.7	95.8	-150	120	-150	120
41	LGA-Z	-53.1	0.0	-52.6	0.0	8	-45.1	-44.6	-150	120	-150	120
45	SAS HOUSING -Z	3.5	0.0	4.2	0.0	8	11.5	12.2	-70	80	-80	90
49	WINDOW SREM	28.5	2.6	29.3	2.6	8	36.5	37.3	-10	50	-45	90
56	AAD HOUSING	62.6	0.0	62.8	0.0	8	70.6	70.8	-70	70	-80	80
70	TANK1	34.3	0.0	34.5	0.0	8	42.3	42.5	10	45	10	45
71	TANK2	33.4	0.0	33.4	0.0	8	41.4	41.4	10	45	10	45

NODE	LABEL	TEMPERATURE RESULTS AND LIMITS										
		Brid	Brid	C 2STR ON	C 2STR ON	UFP [°C]	Brid	C 2STR ON	MIN OPER. [°C]	MAX OPER. [°C]	MIN N.OPER [°C]	MAX N.OPER [°C]
		TEMP [°C]	PW [W]	TEMP [°C]	PW [W]		TEMP-UFP [°C]	TEMP-UFP [°C]				
81	GYRO D1	63.3	0.0	63.3	0.0	0	63.3	63.3	-15	65	-25	65
101	RFDN	36.9	11.8	37.8	11.8	8	44.9	45.8	-25	55	-35	65
122	EPC1_D1	33.1	0.0	44.8	9.0	8	41.1	52.8	-20	60	-30	70
123	EPC2_D1	30.4	9.0	20.2	0.0	8.2	38.6	28.4	-20	60	-30	70
104	TRANSX1	33.1	10.0	41.7	21.0	7.6	40.7	49.3	-10	50	-20	55
105	TRANSX2	35.1	21.0	26.5	10.0	8	43.1	34.5	-10	45	-20	55
126	TWTA1_D1	37.9	0.0	56.2	0.0	7.9	45.8	64.1	-20	60	-30	70
127	TWTA2_D1	38.1	0.0	21.6	0.0	8.1	46.2	29.7	-20	60	-30	70
146	TWTA1_HEAD_D1	38.0	0.0	63.1	32.0	7.9	45.9	71.0	-20	60	-30	70
147	TWTA2_HEAD_D1	43.9	32.0	21.4	0.0	8.1	52.0	29.5	-20	60	-30	70
130	CRS1_D1	43.1	8.3	43.0	8.3	7.3	50.4	50.3	0	50	-10	60
131	CRS2_D1	43.0	8.3	43.8	8.3	7.3	50.3	51.1	0	50	-10	60
221	PCDU_D1	30.2	76.5	30.0	76.5	8	38.2	38.0	-10	47	-20	57
222	CDMU_D1	32.4	37.7	31.5	37.7	8	40.4	39.5	-10	45	-20	55
223	ACC_D1	34.4	32.1	33.3	32.1	8	42.4	41.3	-10	45	-20	55
204	BATT	14.3	2.3	13.7	2.3	8	22.3	21.7	0	35	0	35
321	FPSPU1_2_D1	33.4	30.3	36.6	30.3	8	41.4	44.6	-15	45	-30	60
323	FPDPU_D1	26.7	24.0	30.9	24.0	8	34.7	38.9	-15	45	-30	60
324	FPBOLC_D1	33.6	48.6	19.5	6.6	8	41.6	27.5	-15	45	-30	60
325	FPMECDEC_D1	25.2	21.6	35.7	65.0	8	33.2	43.7	-15	45	-30	60
401	CCU	31.1	5.4	31.6	5.4	8	39.1	39.6	-10	40	-20	50
424	HSDCU_D1	32.2	37.0	32.6	37.0	8	40.2	40.6	-15	45	-35	60
425	HSDPU_D1	29.6	15.3	31.8	15.3	8	37.6	39.8	-15	45	-35	60
426	HSFCU_D1	34.6	42.9	36.2	42.9	8	42.6	44.2	-15	45	-35	60
521	FHWOV_D1_BASE	9.0	1.5	9.0	1.5	0	9.0	9.0	5	15	-25	55
522	FHHRV_D1	23.2	66.3	23.3	66.3	9	32.2	32.3	-10	40	-25	55
523	FHICU_D1	20.0	29.0	20.1	29.0	8.3	28.3	28.4	-25	40	-30	60
524	FHFCU_D1	17.6	13.0	17.7	13.0	8	25.6	25.7	-10	40	-25	55
526	FHWEV_D1	15.8	25.7	15.9	25.7	8	23.8	23.9	0	30	-25	55
507	FHIFV_D1	7.5	0.0	7.6	0.0	8	15.5	15.6	-10	40	-25	55
508	IFV-HRV	18.4	0.0	18.6	0.0	9	27.4	27.6	-10	40	-25	55
509	IFV-WEV	18.4	0.0	18.5	0.0	9	27.4	27.5	-10	40	-25	55
510	WOV-WEV	18.1	0.0	18.3	0.0	9	27.1	27.3	-10	40	-25	55
511	HRV-HRH	24.7	0.0	24.8	0.0	9	33.7	33.8	-10	40	-25	55
621	FHWOH_D1_BASE	9.0	1.5	9.0	1.5	0	9.0	9.0	5	15	-25	55
622	FHWEH_D1	20.8	25.7	20.9	25.7	7.8	28.6	28.7	0	30	-25	55
623	FHHRH_D1	29.3	66.3	29.4	66.3	8.8	38.1	38.2	-10	40	-25	55
624	FHLCU_D1	27.6	37.6	27.7	37.6	8	35.6	35.7	-10	40	-25	55
625	FHLSU_D1	28.4	35.8	28.5	35.8	8	36.4	36.5	10	40	-25	55
606	FHIFH_D1	17.0	0.0	17.1	0.0	8	25.0	25.1	-10	40	-25	55
607	IFH-HRH	25.8	0.0	25.9	0.0	9	34.8	34.9	-10	40	-25	55
608	IFH-WEH	25.9	0.0	26.0	0.0	9	34.9	35.0	-10	40	-25	55
609	WEH-WOH	25.4	0.0	25.4	0.0	9	34.4	34.4	-10	40	-25	55
701	RWL1	40.0	16.0	40.1	16.0	8	48.0	48.1	0	55	-10	65
702	RWL2	38.2	16.0	38.3	16.0	8	46.2	46.3	0	55	-10	65
703	RWL3	39.9	16.0	40.0	16.0	8	47.9	48.0	0	55	-10	65
704	RWL4	39.4	16.0	39.5	16.0	8	47.4	47.5	0	55	-10	65
8133	FCV BODY MAIN	45.6	0.0	45.2	0.0	8	53.6	53.2	10	60	10	60
8233	FCV BODY MAIN	38.9	0.0	38.2	0.0	8	46.9	46.2	10	60	10	60
8333	FCV BODY MAIN	40.9	0.0	39.7	0.0	8	48.9	47.7	10	60	10	60
8433	FCV BODY MAIN	35.8	0.0	36.1	0.0	8	43.8	44.1	10	60	10	60
8533	FCV BODY MAIN	39.7	0.0	39.9	0.0	8	47.7	47.9	10	60	10	60
8633	FCV BODY MAIN	43.0	0.0	43.1	0.0	8	51.0	51.1	10	60	10	60

NODE	LABEL	TEMPERATURE RESULTS AND LIMITS										
		Brid	Brid	C 2STR ON	C 2STR ON	UFP [°C]	Brid	C 2STR ON	MIN OPER. [°C]	MAX OPER. [°C]	MIN N.OPER [°C]	MAX N.OPER [°C]
		TEMP [°C]	PW [W]	TEMP [°C]	PW [W]		TEMP-UFP [°C]	TEMP-UFP [°C]				
8134	FCV BODY REDUNDANT	45.5	0.0	45.0	0.0	8	53.5	53.0	10	60	10	60
8234	FCV BODY REDUNDANT	39.0	0.0	38.3	0.0	8	47.0	46.3	10	60	10	60
8334	FCV BODY REDUNDANT	40.9	0.0	39.7	0.0	8	48.9	47.7	10	60	10	60
8434	FCV BODY REDUNDANT	35.9	0.0	36.2	0.0	8	43.9	44.2	10	60	10	60
8534	FCV BODY REDUNDANT	39.8	0.0	40.0	0.0	8	47.8	48.0	10	60	10	60
8634	FCV BODY REDUNDANT	42.8	0.0	42.9	0.0	8	50.8	50.9	10	60	10	60
80029	STR1+X FOOT	-5.4	0.0	25.4	0.0	(*)	-1.6	32.5	-20	40	-30	50
81029	STR2+X FOOT	7.0	0.0	25.5	0.0	(*)	7.0	32.6	-20	40	-30	50
1501	RCS #9 - LINE 1	40.0	0.0	40.1	0.0	8	48.0	48.1	10	50	10	50
1502	RCS #9 - LINE 1	40.0	0.0	40.1	0.0	8	48.0	48.1	10	50	10	50
1503	RCS #9 - LINE 1	40.0	0.0	40.1	0.0	8	48.0	48.1	10	50	10	50
1504	RCS #9 - LINE 1	40.0	0.0	40.1	0.0	8	48.0	48.1	10	50	10	50
1505	RCS #9 - LINE 1	40.0	0.0	40.1	0.0	8	48.0	48.1	10	50	10	50
1506	RCS #9 - LINE 1	36.2	0.0	36.3	0.0	8	44.2	44.3	10	50	10	50
1507	RCS #9 - LINE 1	39.8	0.0	40.0	0.0	8	47.8	48.0	10	50	10	50
1508	RCS #9 - LINE 1	39.6	0.0	39.7	0.0	8	47.6	47.7	10	50	10	50
1509	RCS #9 - LINE 1	36.2	0.0	36.3	0.0	8	44.2	44.3	10	50	10	50
1512	RCS #9 - LINE 1	37.4	0.0	37.0	0.0	8	45.4	45.0	10	50	10	50
1513	RCS #9 - LINE 1	40.6	0.0	40.9	0.0	8	48.6	48.9	10	50	10	50
1514	RCS #9 - LINE 1	40.1	0.0	39.4	0.0	8	48.1	47.4	10	50	10	50
1515	RCS #9 - LINE 1	40.1	0.0	39.1	0.0	8	48.1	47.1	10	50	10	50
1516	RCS #9 - LINE 1	40.9	0.0	39.7	0.0	8	48.9	47.7	10	50	10	50
1517	RCS #9 - LINE 1	41.1	0.0	40.1	0.0	8	49.1	48.1	10	50	10	50
1518	RCS #9 - LINE 1	42.6	0.0	41.9	0.0	8	50.6	49.9	10	50	10	50
1519	RCS #9 - LINE 1	45.5	0.0	45.1	0.0	8	52.1	52.0	10	50	10	50
1520	RCS #9 - LINE 1	40.0	0.0	40.1	0.0	8	48.0	48.1	10	50	10	50
1522	RCS #9 - LINE 1	42.8	0.0	42.0	0.0	8	50.8	50.0	10	50	10	50
1523	RCS #9 - LINE 1	43.5	0.0	42.9	0.0	8	51.5	50.9	10	50	10	50
1524	RCS #11 - LINE 2	36.0	0.0	35.8	0.0	8	44.0	43.8	10	50	10	50
1525	RCS #11 - LINE 2	36.0	0.0	35.8	0.0	8	44.0	43.8	10	50	10	50
1526	RCS #11 - LINE 2	35.8	0.0	36.6	0.0	8	43.8	44.6	10	50	10	50
1527	RCS #11 - LINE 2	35.5	0.0	36.2	0.0	8	43.5	44.2	10	50	10	50
1528	RCS #11 - LINE 2	35.5	0.0	36.2	0.0	8	43.5	44.2	10	50	10	50
1529	RCS #11 - LINE 2	33.5	0.0	33.4	0.0	8	41.5	41.4	10	50	10	50
1530	RCS #11 - LINE 2	33.5	0.0	33.4	0.0	8	41.5	41.4	10	50	10	50
1531	RCS #11 - LINE 2	32.9	0.0	32.7	0.0	8	40.9	40.7	10	50	10	50
1532	RCS #11 - LINE 2	33.4	0.0	33.3	0.0	8	41.4	41.3	10	50	10	50
1533	RCS #11 - LINE 2	36.2	0.0	35.9	0.0	8	44.2	43.9	10	50	10	50
1534	RCS #11 - LINE 2	36.2	0.0	35.9	0.0	8	44.2	43.9	10	50	10	50
1535	RCS #11 - LINE 2	36.2	0.0	35.9	0.0	8	44.2	43.9	10	50	10	50
1536	RCS #11 - LINE 2	36.2	0.0	35.9	0.0	8	44.2	43.9	10	50	10	50
1537	RCS #11 - LINE 2	35.2	0.0	34.7	0.0	8	43.2	42.7	10	50	10	50
1538	RCS #11 - LINE 2	34.1	0.0	33.1	0.0	8	42.1	41.1	10	50	10	50
1539	RCS #11 - LINE 2	26.7	0.0	25.6	0.0	8	34.7	33.6	10	50	10	50
1540	RCS #11 - LINE 2	26.7	0.0	25.6	0.0	8	34.7	33.6	10	50	10	50
1541	RCS #11 - LINE 2	27.5	0.0	26.1	0.0	8	35.5	34.1	10	50	10	50
1542	RCS #11 - LINE 2	33.3	0.0	31.5	0.0	8	41.3	39.5	10	50	10	50
1543	RCS #11 - LINE 2	39.0	0.0	38.2	0.0	9	48.0	47.2	10	50	10	50
1544	RCS #11 - LINE 2	32.6	0.0	32.3	0.0	8	40.6	40.3	10	50	10	50
1545	RCS #11 - LINE 2	32.6	0.0	32.3	0.0	8	40.6	40.3	10	50	10	50
1546	RCS #11 - LINE 2	32.6	0.0	32.3	0.0	8	40.6	40.3	10	50	10	50
1547	RCS #11 - LINE 2	32.6	0.0	32.3	0.0	8	40.6	40.3	10	50	10	50
1548	RCS #11 - LINE 2	33.8	0.0	33.7	0.0	8	41.8	41.7	10	50	10	50

NODE	LABEL	TEMPERATURE RESULTS AND LIMITS										
		Brid	Brid	C 2STR ON	C 2STR ON	UFP [°C]	Brid	C 2STR ON	MIN OPER. [°C]	MAX OPER. [°C]	MIN N.OPER [°C]	MAX N.OPER [°C]
		TEMP [°C]	PW [W]	TEMP [°C]	PW [W]		TEMP-UFP [°C]	TEMP-UFP [°C]				
1549	RCS #11 - LINE 2	34.6	0.0	34.3	0.0	8	42.6	42.3	10	50	10	50
1550	RCS #11 - LINE 2	34.6	0.0	34.3	0.0	8	42.6	42.3	10	50	10	50
1551	RCS #35 - LINE 3a	32.9	0.0	33.5	0.0	8	40.9	41.5	10	50	10	50
1552	RCS #35 - LINE 3a	32.9	0.0	33.5	0.0	8	40.9	41.5	10	50	10	50
1553	RCS #35 - LINE 3a	32.9	0.0	33.5	0.0	8	40.9	41.5	10	50	10	50
1554	RCS #35 - LINE 3a	32.9	0.0	33.5	0.0	8	40.9	41.5	10	50	10	50
1555	RCS #35 - LINE 3a	32.9	0.0	33.5	0.0	8	40.9	41.5	10	50	10	50
1556	RCS #35 - LINE 3a	31.1	0.0	31.9	0.0	8	39.1	39.9	10	50	10	50
1557	RCS #35 - LINE 3a	31.1	0.0	31.9	0.0	8	39.1	39.9	10	50	10	50
1558	RCS #35 - LINE 3a	31.1	0.0	31.9	0.0	8	39.1	39.9	10	50	10	50
1559	RCS #35 - LINE 3a	31.1	0.0	31.9	0.0	8	39.1	39.9	10	50	10	50
1560	RCS #35 - LINE 3a	31.1	0.0	31.9	0.0	8	39.1	39.9	10	50	10	50
1561	RCS #35 - LINE 3a	31.1	0.0	31.0	0.0	8	39.1	39.0	10	50	10	50
1562	RCS #35 - LINE 3a	31.0	0.0	29.8	0.0	8	39.0	37.8	10	50	10	50
1563	RCS #35 - LINE 3a	30.7	0.0	28.0	0.0	8	38.7	36.0	10	50	10	50
1564	RCS #35 - LINE 3a	30.7	0.0	28.0	0.0	8	38.7	36.0	10	50	10	50
1565	RCS #35 - LINE 3a	30.8	0.0	28.7	0.0	8	38.8	36.7	10	50	10	50
1566	RCS #35 - LINE 3a	30.0	0.0	27.4	0.0	8	38.0	35.4	10	50	10	50
1567	RCS #35 - LINE 3a	40.9	0.0	39.7	0.0	8	48.9	47.7	10	50	10	50
1450	RCS#48-3b- LF	28.5	0.0	29.7	0.0	8	36.5	37.7	10	50	10	50
1477	RCS#48-3b- LV1	29.3	0.0	30.5	0.0	8	37.3	38.5	10	50	10	50
1482	RCS#48-3b- LV2	29.1	0.0	30.3	0.0	8	37.1	38.3	10	50	10	50
1487	RCS#48-3b- PT	24.1	0.0	25.3	0.0	8	32.1	33.3	10	50	10	50
1568	RCS #37 - LINE 3c	30.1	0.0	30.9	0.0	8	38.1	38.9	10	50	10	50
1569	RCS #37 - LINE 3c	30.4	0.0	31.0	0.0	8	38.4	39.0	10	50	10	50
1570	RCS #37 - LINE 3c	32.2	0.0	32.7	0.0	8	40.2	40.7	10	50	10	50
1571	RCS #37 - LINE 3c	32.2	0.0	32.7	0.0	8	40.2	40.7	10	50	10	50
1572	RCS #37 - LINE 3c	30.4	0.0	31.0	0.0	8	38.4	39.0	10	50	10	50
1573	RCS #37 - LINE 3c	29.9	0.0	30.9	0.0	8	37.9	38.9	10	50	10	50
1574	RCS #37 - LINE 3c	29.5	0.0	30.7	0.0	8	37.5	38.7	10	50	10	50
1576	RCS #37 - LINE 3c	28.4	0.0	29.6	0.0	8	36.4	37.6	10	50	10	50
1578	RCS #37 - LINE 3c	29.7	0.0	30.7	0.0	8	37.7	38.7	10	50	10	50
1580	RCS #37 - LINE 3c	30.2	0.0	31.0	0.0	8	38.2	39.0	10	50	10	50
1581	RCS #37 - LINE 3c	29.6	0.0	30.7	0.0	8	37.6	38.7	10	50	10	50
1583	RCS #37 - LINE 3c	28.5	0.0	29.8	0.0	8	36.5	37.8	10	50	10	50
1584	RCS #37 - LINE 3c	29.1	0.0	30.3	0.0	8	37.1	38.3	10	50	10	50
1585	RCS #37 - LINE 3c	28.5	0.0	29.8	0.0	8	36.5	37.8	10	50	10	50
1586	RCS #37 - LINE 3c	28.2	0.0	29.4	0.0	8	36.2	37.4	10	50	10	50
1588	RCS #37 - LINE 3c	31.2	0.0	31.6	0.0	8	39.2	39.6	10	50	10	50
1589	RCS #37 - LINE 3c	32.7	0.0	33.1	0.0	8	40.7	41.1	10	50	10	50
1590	RCS #37 - LINE 3c	29.2	0.0	29.5	0.0	8	37.2	37.5	10	50	10	50
1591	RCS #37 - LINE 3c	31.4	0.0	31.7	0.0	8	39.4	39.7	10	50	10	50
1592	RCS #37 - LINE 3c	31.4	0.0	31.7	0.0	8	39.4	39.7	10	50	10	50
1593	RCS #37 - LINE 3c	31.8	0.0	32.1	0.0	8	39.8	40.1	10	50	10	50
1594	RCS #37 - LINE 3c	35.8	0.0	36.2	0.0	8	43.8	44.2	10	50	10	50
1595	RCS #45 - LINE 4	31.2	0.0	31.6	0.0	8	39.2	39.6	10	50	10	50
1596	RCS #45 - LINE 4	31.2	0.0	31.6	0.0	8	39.2	39.6	10	50	10	50
1597	RCS #45 - LINE 4	31.2	0.0	31.6	0.0	8	39.2	39.6	10	50	10	50
1598	RCS #45 - LINE 4	31.2	0.0	31.6	0.0	8	39.2	39.6	10	50	10	50
1599	RCS #45 - LINE 4	31.2	0.0	31.6	0.0	8	39.2	39.6	10	50	10	50
1400	RCS #45 - LINE 4	32.8	0.0	33.2	0.0	8	40.8	41.2	10	50	10	50
1401	RCS #45 - LINE 4	32.8	0.0	33.2	0.0	8	40.8	41.2	10	50	10	50
1402	RCS #45 - LINE 4	32.8	0.0	33.2	0.0	8	40.8	41.2	10	50	10	50

NODE	LABEL	TEMPERATURE RESULTS AND LIMITS										
		Brid	Brid	C 2STR ON	C 2STR ON	UFP [°C]	Brid	C 2STR ON	MIN OPER. [°C]	MAX OPER. [°C]	MIN N.OPER [°C]	MAX N.OPER [°C]
		TEMP [°C]	PW [W]	TEMP [°C]	PW [W]		TEMP-UFP [°C]	TEMP-UFP [°C]				
1403	RCS #45 - LINE 4	32.8	0.0	33.2	0.0	8	40.8	41.2	10	50	10	50
1404	RCS #45 - LINE 4	32.8	0.0	33.2	0.0	8	40.8	41.2	10	50	10	50
1405	RCS #45 - LINE 4	31.2	0.0	31.6	0.0	8	39.2	39.6	10	50	10	50
1406	RCS #45 - LINE 4	31.3	0.0	31.6	0.0	8	39.3	39.6	10	50	10	50
1407	RCS #45 - LINE 4	28.4	0.0	28.7	0.0	8	36.4	36.7	10	50	10	50
1408	RCS #45 - LINE 4	28.4	0.0	28.7	0.0	8	36.4	36.7	10	50	10	50
1409	RCS #45 - LINE 4	27.7	0.0	28.0	0.0	8	35.7	36.0	10	50	10	50
1410	RCS #45 - LINE 4	27.6	0.0	27.8	0.0	8	35.6	35.8	10	50	10	50
1411	RCS #45 - LINE 4	39.8	0.0	39.9	0.0	8	47.8	47.9	10	50	10	50
1412	RCS #46 - LINE 5a	34.2	0.0	34.5	0.0	8	42.2	42.5	10	50	10	50
1413	RCS #46 - LINE 5a	34.2	0.0	34.5	0.0	8	42.2	42.5	10	50	10	50
1414	RCS #46 - LINE 5a	34.2	0.0	34.5	0.0	8	42.2	42.5	10	50	10	50
1415	RCS #46 - LINE 5a	34.2	0.0	34.5	0.0	8	42.2	42.5	10	50	10	50
1416	RCS #46 - LINE 5a	36.2	0.0	36.4	0.0	8	44.2	44.4	10	50	10	50
1417	RCS #46 - LINE 5a	36.2	0.0	36.4	0.0	8	44.2	44.4	10	50	10	50
1418	RCS #46 - LINE 5a	36.2	0.0	36.4	0.0	8	44.2	44.4	10	50	10	50
1419	RCS #46 - LINE 5a	35.2	0.0	35.4	0.0	8	43.2	43.4	10	50	10	50
1421	RCS #46 - LINE 5a	34.3	0.0	34.6	0.0	8	42.3	42.6	10	50	10	50
1422	RCS #46 - LINE 5a	34.4	0.0	34.7	0.0	8	42.4	42.7	10	50	10	50
1423	RCS #46 - LINE 5a	34.4	0.0	34.7	0.0	8	42.4	42.7	10	50	10	50
1424	RCS #46 - LINE 5a	34.4	0.0	34.7	0.0	8	42.4	42.7	10	50	10	50
1425	RCS #46 - LINE 5a	34.4	0.0	34.7	0.0	8	42.4	42.7	10	50	10	50
1426	RCS #47 - LINE 5b	35.7	0.0	35.8	0.0	8	43.7	43.8	10	50	10	50
1427	RCS #47 - LINE 5b	35.8	0.0	36.0	0.0	8	43.8	44.0	10	50	10	50
1428	RCS #47 - LINE 5b	36.2	0.0	36.3	0.0	8	44.2	44.3	10	50	10	50
1429	RCS #47 - LINE 5b	36.2	0.0	36.4	0.0	8	44.2	44.4	10	50	10	50
1430	RCS #47 - LINE 5b	38.9	0.0	39.0	0.0	8	46.9	47.0	10	50	10	50
1431	RCS #47 - LINE 5b	38.9	0.0	39.0	0.0	8	46.9	47.0	10	50	10	50
1432	RCS #47 - LINE 5b	36.2	0.0	36.4	0.0	8	44.2	44.4	10	50	10	50
1433	RCS #47 - LINE 5b	36.2	0.0	36.4	0.0	8	44.2	44.4	10	50	10	50
1434	RCS #47 - LINE 5b	36.2	0.0	36.4	0.0	8	44.2	44.4	10	50	10	50
1435	RCS #47 - LINE 5b	36.2	0.0	36.4	0.0	8	44.2	44.4	10	50	10	50
1437	RCS #47 - LINE 5b	35.5	0.0	35.6	0.0	8	43.5	43.6	10	50	10	50
1438	RCS #47 - LINE 5b	34.0	0.0	34.2	0.0	8	42.0	42.2	10	50	10	50
1439	RCS #47 - LINE 5b	34.0	0.0	34.2	0.0	8	42.0	42.2	10	50	10	50
1440	RCS #47 - LINE 5b	33.3	0.0	33.4	0.0	8	41.3	41.4	10	50	10	50
1441	RCS #47 - LINE 5b	36.5	0.0	36.6	0.0	8	44.5	44.6	10	50	10	50
1442	RCS #47 - LINE 5b	42.9	0.0	43.0	0.0	8	50.9	51.0	10	50	10	50

(\*) the STR uncertainty is: with control law 0°C for STR “on” and 3.8°C for STR “off”; without control law 7.1°C for STR “on”

Table 8.4.4-1 HERSCHEL – Redundancy analysis temperature results

## 8.5 PLANCK Thermal analysis

### TRANSIENT NOMINAL ANALYSIS

The nominal analysis have been performed considering transient cases with the S/C operating 21 hours in Scientific mode and 3 hrs in Telecom mode. The analysis takes into account also the cyclic variation of SCC power dissipation on each bed (see paragraph 5.2.2.1)

The list of the orbital Transient cases analysed is presented in the following table:

CASE	BOL / EOL	SUN ON PANEL	SAA [deg]	ATTITUDE	SOLAR CONSTANT [W/m <sup>2</sup> ]	Remarks
<b>A1</b>	BOL	+Z	10	Rot X = 0 Rot Y = +10	Summer: 1285	Nominal BOL – Dissipation MODE1
<b>A2</b>	BOL	+Z	10	Rot X = 0 Rot Y = +10	Summer: 1285	Nominal BOL – Dissipation MODE2
<b>A3</b>	BOL	+Z	10	Rot X = 0 Rot Y = +10	Summer: 1285	Nominal BOL – Dissipation MODE3
<b>B1</b>	EOL	+Z	0	Rot X = 0 Rot Y = 0	Winter: 1405	Nominal EOL – SCC1 on
<b>B2</b>	EOL	+Z	0	Rot X = 0 Rot Y = 0	Winter: 1405	Nominal EOL – SCC2 on
<b>C</b>	BOL	+Z	10	Rot X = 0 Rot Y = +10	Summer: 1285	Survival BOL

Table 8.5-1- PLANCK Transient nominal analysis cases

The spin of the satellite around its X-axis (1.7 round per minute) has a negligible effect on the amount of solar fluxes on the sun-exposed surfaces, so it is not considered in the current analysis.

### CHANGE OF ATTITUDE TRANSIENT ANALYSIS

To verify the thermal stability requirement for the SCC Radiative Panels and the SVM/PLM I/F points transient analysis have been performed taking into account the variation of SCC Power dissipation on each bed; moreover a change of attitude of the satellite from SAA=0° to SAA=10° has been considered at time = 86400 sec.

The analysed cases are the following:

- **Cold Transient (Case P1):**  
 Starting from S/S BOL case with Sun on –X and SAA= 0°. Solar constant=1285 W/m<sup>2</sup>  
 Ending to S/S BOL case with Sun on –X and SAA=+10°. Solar constant=1285 W/m<sup>2</sup>  
 Duration of change of attitude: 1200s  
 Rotation rate: 0.5°/min  
 Overall duration of transient case: 348600s (72 hours)  
 Dissipation as per nominal case A1 (with SCC1 on and SCC2 off)

- **Cold Transient (Case P2):**  
Starting from S/S BOL case with Sun on  $-X$  and  $SAA=0^\circ$ . Solar constant= $1285 \text{ W/m}^2$   
Ending to S/S BOL case with Sun on  $-X$  and  $SAA=+10^\circ$ . Solar constant= $1285 \text{ W/m}^2$   
Duration of change of attitude: 1200s  
Rotation rate:  $0.5^\circ/\text{min}$   
Overall duration of transient case: 348600s (72 hours)  
Dissipation as per nominal case A1 (with SCC1 off and SCC2 on)
- **Hot Transient (Case Q1):**  
Starting from S/S EOL case with Sun on  $-X$  and  $SAA=0^\circ$ . Solar constant= $1405 \text{ W/m}^2$   
Ending to S/S EOL case with Sun on  $-X$  and  $SAA=+10^\circ$ . Solar constant= $1405 \text{ W/m}^2$   
Duration of change of attitude: 1200s  
Rotation rate:  $0.5^\circ/\text{min}$   
Overall duration of transient case: 348600s (72 hours)  
Dissipation as per nominal case B1
- **Hot Transient (Case Q2):**  
Starting from S/S EOL case with Sun on  $-X$  and  $SAA=0^\circ$ . Solar constant= $1405 \text{ W/m}^2$   
Ending to S/S EOL case with Sun on  $-X$  and  $SAA=+10^\circ$ . Solar constant= $1405 \text{ W/m}^2$   
Duration of change of attitude: 1200s  
Rotation rate:  $0.5^\circ/\text{min}$   
Overall duration of transient case: 348600s (72 hours)  
Dissipation as per nominal case B2

#### REDUNDANCY TRANSIENT ANALYSIS

A series of additional analysis have been performed to verify the temperatures behaviour when the redundancy units are activated. The analysis results are reported in paragraph 8.5.4.4

### 8.5.1 SCC dissipation profile

The working SCC has a dissipation profile of 667s, while the single bed has a whole cycle in 4002 s ( 6 time 667s).

Each SCC is composed of six thermal nodes for the Inner bed and six for the Outer shell, for each thermal node is considered the thermal capacity, the linear conductor and the power dissipation for each phase and has been utilised a simplified BOL and EOL thermal mathematical model reported in Table 5.2.2.1-1/2

In Table 8.5.1-X are reported the value relative to Gas gap conductance for a period time of 1334 sec up to 2000 one .





Alcatel Alenia Space Italia S.p.A.

DOC. No : H-P-RP-AI-0040  
 ISSUE : 05  
 DATE : 24/FEB/06  
 PAGE : 153 of 341  
 CLASS. : DC  
 ANNEXES : ..... Pages....

## Highly Simplified BOL Thermal Model of 20 K Sorption Cooler Compressor Assembly

*(To be used by Alcatel to simulate compressor interface with radiator)*

(Pradeep Bhandari, Mauro Prina, 11-15- (Phone: 818-354-7597) [Modified Model](#)  
 2001)

Parameter	Location	Units	Phase 1	Phase 2	Phase 3	Phase 4	Phase 5	Phase 6	Phase Cycle Time
			Heatup 0-667 s	Desorb 667-1334 s	Cool 1334-2000 s	Absorb 2001-2667 s	Absorb 2668-3333 s	Absorb 3335-4000 s	
Therm. Mass	Inner Bed	MC <sub>p</sub> (J/K)	800	3600	900	670	690	710	
	Outer Shell	MC <sub>p</sub> (J/K)	720	720	720	720	720	720	
Conductance	(Inner Bed to Outer Shell)	W/K	0.02	0.03	***	6.53	6.53	6.53	
Heat Input	Inner Bed	W	201	150	0	36	36	36	
	Outer shell	W	0	0	7	7	7	7	

\*\* see attached table

*(Gas-Gap Conductance Worksheet)*

BOL Model

### Notes:

- 1) The above values are for beginning of life (excluding margin)
- 2) The total cycle time is 667\*6 = 4000 seconds.
- 3) There are 6 identical beds which are of phase, by one phase width of 667 sec., with respect to each other.

Highly Simplified EOL Thermal Model of 20 K Sorption Cooler Compressor Assembly																																	
<i>(To be used by Alcatel to simulate compressor interface with radiator)</i>																																	
(Pradeep Bhandari, Mauro Prina, 11-15-2001)			(Phone: 818-354-7597)			Modified Model																											
Parameter	Location	Units	Phase 1 Heatup 0-667 s	Phase 2 Desorb 667-1334 s	Phase 3 Cool 1334-2000 s	Phase 4 Absorb 2001-2667 s	Phase 5 Absorb 2668-3333 s	Phase 6 Absorb 3335-4000 s	Phase Cycle Time																								
Therm. Mass	Inner Bed	MC <sub>p</sub> (J/K)	800	3600	930	670	690	710																									
	Outer Shell	MC <sub>p</sub> (J/K)	720	720	720	720	720	720																									
Conductance	(Inner Bed to Outer Shell)	W/K	0.02	0.03	***	6.53	6.53	6.53																									
Heat Input	Inner Bed	W	216	183	0	36	36	36																									
	Outer shell	W	21	21	7	7	7	7																									
	<b>Total</b>	W							<b>469 Watts (EOL + Margin)</b>																								
** see attached table																																	
<p>Notes:</p> <p>1) The above values are for end of life (including margin)</p> <p>2) The total cycle time is 667*6 = 4000 seconds.</p> <p>3) There are 6 identical beds which are of phase, by one phase width of 667 sec., with respect to each other.</p> <p>4) At any time one bed is heating up, one desorbing, one cooling, and three absorbing.</p> <p>5) Outer shell is thermally and structurally connected to the radiator.</p> <p>6) Additional thermal masses for items outside of the compressor elements need to be accounted for to ensure that the radiator thermal oscillations are not excessive.</p>																																	
<p><b>Sample Output of Inner Bed Temperature (From Detailed Cooler Model)</b></p> <table border="1"> <caption>Inner Bed Temperature Profile Data</caption> <thead> <tr> <th>Time (s)</th> <th>Phase</th> <th>Temperature (K)</th> </tr> </thead> <tbody> <tr> <td>0</td> <td>Heatup</td> <td>~270</td> </tr> <tr> <td>667</td> <td>Desorb</td> <td>~450</td> </tr> <tr> <td>1334</td> <td>Cool</td> <td>~450</td> </tr> <tr> <td>2000</td> <td>Absorb</td> <td>~280</td> </tr> <tr> <td>2667</td> <td>Absorb</td> <td>~280</td> </tr> <tr> <td>3333</td> <td>Absorb</td> <td>~280</td> </tr> <tr> <td>4000</td> <td>Absorb</td> <td>~280</td> </tr> </tbody> </table>										Time (s)	Phase	Temperature (K)	0	Heatup	~270	667	Desorb	~450	1334	Cool	~450	2000	Absorb	~280	2667	Absorb	~280	3333	Absorb	~280	4000	Absorb	~280
Time (s)	Phase	Temperature (K)																															
0	Heatup	~270																															
667	Desorb	~450																															
1334	Cool	~450																															
2000	Absorb	~280																															
2667	Absorb	~280																															
3333	Absorb	~280																															
4000	Absorb	~280																															

Table 8.5.1-2 PLANCK - Simplified EOL SCC model

Time	Gas gap Conductance	Time	Gas gap Conductance	Time	Gas gap Conductance	Time	Gas gap Conductance
[s]	[W/K]	[s]	[W/K]	[s]	[W/K]	[s]	[W/K]
0	0.0313	341	2.3479	394	6.2940	447	6.5519
286	0.0314	342	2.6215	395	6.3069	448	6.5525
289	0.0316	343	2.8875	396	6.3187	449	6.5530
291	0.0318	344	3.1393	397	6.3307	450	6.5534
292	0.0319	345	3.3734	398	6.3420	451	6.5536
293	0.0321	346	3.5880	399	6.3526	452	6.5537
294	0.0325	347	3.7832	400	6.3634	453	6.5539
295	0.0329	348	3.9600	401	6.3728	454	6.5541
296	0.0331	349	4.2804	402	6.3824	455	6.5542
297	0.0337	350	4.4133	403	6.3914	667	6.5543
298	0.0344	351	4.5360	404	6.4003		
299	0.0352	352	4.6454	405	6.4086		
300	0.0359	353	4.7481	406	6.4171		
301	0.0368	354	4.8422	407	6.4247		
302	0.0383	355	4.9295	408	6.4321		
303	0.0397	356	5.0096	409	6.4391		
304	0.0414	357	5.0853	410	6.4456		
305	0.0434	358	5.1568	411	6.4516		
306	0.0459	359	5.2245	412	6.4578		
307	0.0487	360	5.2856	413	6.4636		
308	0.0519	361	5.3454	414	6.4689		
309	0.0558	362	5.4002	415	6.4738		
310	0.0602	363	5.4532	416	6.4793		
311	0.0653	364	5.5034	417	6.4837		
312	0.0709	365	5.5503	418	6.4887		
313	0.0775	366	5.5956	419	6.4932		
314	0.0849	367	5.6379	420	6.4971		
315	0.0934	368	5.6789	421	6.5009		
316	0.1029	369	5.7178	422	6.5049		
317	0.1137	370	5.7541	423	6.5083		
318	0.1258	371	5.7893	424	6.5119		
319	0.1393	372	5.8235	425	6.5151		
320	0.1546	373	5.8553	426	6.5183		
321	0.1716	374	5.8862	427	6.5214		
322	0.1908	375	5.9163	428	6.5242		
323	0.2123	376	5.9436	429	6.5264		
324	0.2366	377	5.9708	430	6.5291		
325	0.2641	378	5.9967	431	6.5315		
326	0.2956	379	6.0219	432	6.5335		
327	0.3317	380	6.0453	433	6.5356		
328	0.3735	381	6.0680	434	6.5373		
329	0.4224	382	6.0902	435	6.5393		
330	0.4799	383	6.1119	436	6.5409		
331	0.5482	384	6.1314	437	6.5423		
332	0.6297	385	6.1514	438	6.5436		
333	0.7276	386	6.1705	439	6.5450		
334	0.8556	387	6.1886	440	6.5463		
335	0.9855	388	6.2058	441	6.5473		
336	1.1518	389	6.2216	442	6.5480		
337	1.3457	390	6.2375	443	6.5488		
338	1.5667	391	6.2526	444	6.5497		
339	1.8118	392	6.2673	445	6.5505		
340	2.0749	393	6.2808	446	6.5512		

Table 8.5.1-3 PLANCK - Gas gap conductance

### 8.5.2 Planck Heater Sizing and Breakdown

The Heater circuit breakdown with the heater power impressed on the TMM nodes is shown in Table 5.2.3-1

Table 8.5.2-1 PLANCK – Heater Circuits Breakdown and Temperature Thresholds

Heater line	TCS ID	HEATER's location	Heaters on Node	Power on node [W]	Power line @27 V [W]	ENABLED in NOMINAL	ENABLED in SURVIVAL	Threshold Nom. [°C]	Threshold Surv. [°C]
TCS Line 01	HTR5427S	close to STR 1	5481	1.175	4.70	NO	YES	N/A	-29/-26
			5482	1.175					
			5483	1.175					
			5484	1.175					
TCS Line 02	HTR5527S	close to STR 2	5581	1.175	4.70	NO	YES	N/A	-29/-26
			5582	1.175					
			5583	1.175					
			5584	1.175					
TCS Line 03	HTR13S	close to DPU1	6026	11.39	22.78	NO	YES	N/A	-19/-16
			6044	11.39					
TCS Line 04	HTR14S	close to DPU2	6047	11.39	22.78	NO	YES	N/A	-19/-16
			6029	11.39					
TCS Line 05	HTR205S	close to REU	6248	15.51	62.00	NO	YES	N/A	-19/-16
			6245	15.51					
			6232	15.51					
			6229	15.51					
TCS Line 06	HTR220S	close to CEU, CCU			51.92	NO	YES	N/A	-18/-15
			6215	15.51					
			6210	15.855					
			6211	15.855					
			6218	2.35					
TCS Line 07		on Heat Pipes	802	26.00	78.00	YES	YES	-13/-12	-13/-12
			805	26.00					
			808	26.00					
TCS Line 08		on Heat Pipes	851	26.00	78.00	YES	YES	-14/-13	-14/-13
			854	26.00					
			857	26.00					
TCS Line 09		on Heat Pipes	801	6.5	91	YES	YES	-15/-14	-15/-14
			803	6.5					
			804	26.00					
			806	26.00					
			807	26.00					
TCS Line 10		on Heat Pipes	852	6.5	91	YES	YES	-16/-15	-16/-15
			853	6.5					
			855	26.00					
			856	26.00					
			858	26.00					
TCS Line 11		on Heat Pipes	802	6.5	91	YES	YES	-17/-16	-17/-16
			852	6.5					
			855	26.00					
			806	26.00					
			808	26.00					

Heater line	TCS ID	HEATER's location	Heaters on Node	Power on node [W]	Power line @27 V [W]	ENABLED in NOMINAL	ENABLED in SURVIVAL	Threshold Nom. [°C]	Threshold Surv. [°C]
TCS Line 12		on Heat Pipes	851	6.5	91	YES	YES	-18/-17	-18/-17
			803	6.5					
			807	26.00					
			857	26.00					
			858	26.00					
TCS Line 13		on Heat Pipes	801	6.5	91	YES	YES	-19/-18	-19/-18
			853	6.5					
			804	26.00					
			854	26.00					
			856	26.00					
TCS Line 14	HTR910 NS	on Helium TANKS	910	1.54	3.08	YES	YES	-9/-6	-19/-16
			900	0.77					
			905	0.77					
TCS Line 15	HTR522S	close to PAU	598	8.1	8.1	NO	YES	N/A	-19/-16
TCS Line 16	HTR203S	close to CRU (4K Pre Reg)	5152	8.1 + 4.7	12.8	NO	YES	N/A	-19/-16
TCS Line 21	HTR920 NS	on TANK +Z+Y	920	6.17	6.17	YES	YES	11/14	14/17
TCS Line 22	HTR925 NS	on TANK +Z-Y	925	6.17	6.17	YES	YES	11/14	14/17
TCS Line 23	HTR930 NS	on TANK -Z	930	6.17	6.17	YES	YES	11/14	14/17
TCS Line 24	HTR8508NS	on FCV A1	8508	2.35	2.35	YES	YES	14/17	14/17
TCS Line 25	HTR8608NS	on FCV A2	8608	2.35	2.35	YES	YES	14/17	14/17
TCS Line 26	HTR1133NS	on FCV D1A	1133	2.35	2.35	YES	YES	14/17	14/17
TCS Line 27	HTR1233NS	on FCV D2A	1233	2.35	2.35	YES	YES	14/17	14/17
TCS Line 28	HTR1333NS	on FCV F1A	1333	2.35	2.35	YES	YES	14/17	14/17
TCS Line 29	HTR1433NS	on FCV F2A	1433	2.35	2.35	YES	YES	14/17	14/17
TCS Line 30	HTR1533NS	on FCV U1A	1533	2.35	2.35	YES	YES	14/17	14/17
TCS Line 31	HTR1733NS	on FCV U2A	1733	2.35	2.35	YES	YES	14/17	14/17
TCS Line 32		RCS Line 1			4.9	YES	YES	19/20	19/20
TCS Line 33		RCS Line 2			3.96	YES	YES	32/33	21/22
TCS Line 34		RCS Line 3			5.27	YES	YES	28/29	20/21
TCS Line 35	HTR202S	close to CAU	6241	8.10	38.98	YES	YES	-9/-6	-19/-16
			6225	11.39					
			6243	8.10					
			6227	11.39					
TCS Line 36	HTR103S	close to REBA1, REBA2	6145	11.39	22.78	NO	YES	N/A	-29/-26
			6133	11.39					
TCS Line 37	HTR703S	inside BATTERY	703	14.90	14.90	NO	YES	1/4	1/4
TCS Line 38	HTR8708NS	on FCV B1	8708	2.35	2.35	YES	YES	14/17	14/17
TCS Line 39	HTR8808NS	on FCV B2	8808	2.35	2.35	YES	YES	14/17	14/17
TCS Line 40	HTR1134NS	on FCV D1B	1134	2.35	2.35	YES	YES	14/17	14/17
TCS Line 41	HTR1234NS	on FCV D2B	1234	2.35	2.35	YES	YES	14/17	14/17
TCS Line 42	HTR1334NS	on FCV F1B	1334	2.35	2.35	YES	YES	14/17	14/17
TCS Line 43	HTR1434NS	on FCV F2B	1434	2.35	2.35	YES	YES	14/17	14/17
TCS Line 44	HTR1534NS	on FCV U1B	1534	2.35	2.35	YES	YES	14/17	14/17
TCS Line 45	HTR1734NS	on FCV U2B	1734	2.35	2.35	YES	YES	14/17	14/17
TCS Line 46		RCS Line 4			4.03	YES	YES	35/36	22/23
TCS Line 47		RCS Line 5			3.78	YES	YES	29/30	20/21
TCS Line 48		RCS Line 6			3.27	YES	YES	19/20	20/21

### 8.5.3 Thermal stability

The PLANCK thermal stability requirements (ITP-220-P and ITP-230-P) relevant to Spectral Density (SD) and Fourier transform amplitude has been calculated as described below.

The software used is MathCad and the Fourier transform is computed as follow:

$$S_j = \frac{1}{\sqrt{N+1}} \sum_{k=0}^N s_K e^{\frac{2\pi ijk}{(N+1)}}$$

(Note: the normalisation

$$\frac{1}{\sqrt{N+1}}$$

is that utilised by MathCad for the computation of the discrete Fourier transform.)

The Power Spectral Density ( $PSD_{sj}$ ) is computed as follow:

$$PSD_{sj} = 2 \frac{|S_j|^2}{N+1} t_{\max} = 2N\Delta t \frac{|S_j|^2}{N+1}$$

The measurement unit of the PSD is [ $K^2/Hz$ ], and consequently the  $SD_{sj}$ , to be used for the verification of the ITP-230-P, is:

$$SD_{sj} = \sqrt{PSD_{s,j}} = \sqrt{2N\Delta t} \frac{|S_j|}{\sqrt{N+1}}$$

with a measurement unit [ $K/Hz^{1/2}$ ].

The temperature time history used to compute the  $SD$  is 7200 s long with a sampling time of 20 s as specified in the ITP-230-P. The start time of the time history occurs at the beginning of the S/C attitude change.

Concerning the amplitude of the Fourier Transform to be used for the verification of the ITP-220-P, the following applies.

Giving the Fourier transform ( $S_j$ ) computed as above the amplitude is:

$$\text{amplitude}_{S_j} := \frac{|S_j|}{\sqrt{N+1}} \cdot 2$$

The measurement unit of the Fourier Transform Amplitude is [ $K$ ].

The temperature time history used to compute the Fourier Transform Amplitude is 16008 s long (4 SCC complete cycle (4002s each one)) with a sampling time of 1 s. The start time of the time history occurs at the beginning of the S/C attitude change.



Alcatel Alenia Space Italia S.p.A.

DOC. No : H-P-RP-AI-0040  
 ISSUE : 05  
 DATE : 24/FEB/06  
 PAGE : 159 of 341  
 CLASS. : DC  
 ANNEXES : ..... Pages....

### 8.5.4 Planck thermal analysis results

#### 8.5.4.1 Transient nominal results

The temperature results of transient nominal analysis are reported in the table 5.2.5.1-1. The Table contains for the main S/L items, the relevant TMM node, its description, the uncertainty applied, the temperature results in the transient nominal analysis with the minimum values reported for the Cold cases and the maximum values reported for the Hot cases, the temperature with the relative uncertainty applied, the heater enabled according to the case analysed, identified by the “h” reported near the temperature value, the operative and non operative limits. All the temperatures are in degree Celsius.

The temperature uncertainty used is the one evaluated and reported in AD21 except for the following:

- In Cold cases (A1,A2,A3 and C) uncertainty are not applied to the units controlled by heaters
- In Hot cases (B1 and B2) uncertainty on SCC nodes is not applied due to the operating heater control also in these cases.

For RCS nodes, the uncertainty is always applied (both in hot and cold cases), and a value of 8°C has been assumed.

Table 8.5.4.1 PLANCK – Units Temperature Results

NODE	LABEL	UFP													TEMPERATURE LIMIT				
			CASE A1	CASE A2	CASE A3	CASE C	CASE B1	CASE B2	CASE A1	CASE A2	CASE A3	CASE C	CASE B1	CASE B2	MIN	MAX	MIN	MAX	
			Min	Min	Min	Min	Max	Max	Tmin - UFP	Tmin - UFP	Tmin - UFP	Tmin - UFP	Tmax +UFP	Tmax +UFP	OPER.	OPER.	N.OPE R	N.OPE R	
5427	STR_MY -X FOOT	9.2	17.0	15.6	14.5	-29.0	21.7	21.8	7.8	6.4	5.3	-29.0	h	30.9	31.0	-20.0	40.0	-30.0	50.0
5428	STR_MY +Y FOOT	9.2	17.0	15.6	14.5	-29.2	21.8	21.8	7.8	6.4	5.3	-29.2	h	31.0	31.0	-20.0	40.0	-30.0	50.0
5429	STR_MY +X FOOT	9.2	16.8	15.4	14.3	-29.1	21.6	21.6	7.6	6.2	5.1	-29.1	h	30.8	30.8	-20.0	40.0	-30.0	50.0
5430	STR_MY -Y FOOT	9.2	16.9	15.5	14.4	-29.2	21.7	21.7	7.7	6.3	5.2	-29.2	h	30.9	30.9	-20.0	40.0	-30.0	50.0
5527	STR_PY -X FOOT	7.3	-14.4	-15.9	-18.8	-29.0	-9.2	-9.2	-21.7	-23.2	-26.1	-29.0	h	-1.9	-1.9	-20.0	40.0	-30.0	50.0
5528	STR_PY +Y FOOT	7.3	-14.4	-16.0	-18.9	-29.0	-9.3	-9.3	-21.7	-23.3	-26.2	-29.0	h	-2.0	-2.0	-20.0	40.0	-30.0	50.0

NODE	LABEL	UFP													TEMPERATURE LIMIT									
			CASE A1	CASE A2	CASE A3	CASE C	CASE B1	CASE B2	CASE A1	CASE A2	CASE A3	CASE C	CASE B1	CASE B2	MIN	MAX	MIN	MAX						
			Min	Min	Min	Min	Max	Max	Tmin - UFP	Tmin - UFP	Tmin - UFP	Tmin - UFP	Tmax +UFP	Tmax +UFP	OPER.	OPER.	N.OPE R	N.OPE R						
5529	STR_PY +X FOOT	7.3	-14.5	-16.0	-18.9	-29.0	-9.3	-9.3	-21.8	-23.3	-26.2	-29.0	h	-2.0	-2.0	<b>-20.0</b>	<b>40.0</b>	<b>-30.0</b>	<b>50.0</b>					
5530	STR_PY -Y FOOT	7.2	-14.4	-16.0	-18.9	-29.0	-9.3	-9.3	-21.6	-23.2	-26.1	-29.0	h	-2.1	-2.1	<b>-20.0</b>	<b>40.0</b>	<b>-30.0</b>	<b>50.0</b>					
13	DPU1	8.1	<b>6.9</b>	<b>5.2</b>	<b>2.5</b>	-19.1	<b>12.2</b>	<b>12.2</b>	-1.2	-2.9	-5.6	-19.1	h	20.3	20.3	<b>-10.0</b>	<b>40.0</b>	<b>-20.0</b>	<b>50.0</b>					
14	DPU2	7.6	-4.6	-6.6	-7.8	-19.0	0.9	0.9	-12.2	-14.2	-15.4	-19.0	h	8.5	8.5	<b>-10.0</b>	<b>40.0</b>	<b>-20.0</b>	<b>50.0</b>					
101	DCCU	8	<b>13.2</b>	<b>11.2</b>	<b>9.7</b>	-16.2	<b>19.4</b>	<b>19.4</b>	5.2	3.2	1.7	-24.2		27.4	27.4	<b>-10.0</b>	<b>40.0</b>	<b>-20.0</b>	<b>50.0</b>					
102	REBA1	8.5	<b>28.3</b>	<b>26.8</b>	<b>23.5</b>	-25.3	<b>33.8</b>	<b>33.9</b>	19.8	18.3	15.0	-25.3	h	42.3	42.4	<b>-20.0</b>	<b>50.0</b>	<b>-30.0</b>	<b>50.0</b>					
103	REBA2	7.8	-3.9	-5.7	-8.5	-29.0	2.2	2.3	-11.7	-13.5	-16.3	-29.0	h	10.0	10.1	<b>-20.0</b>	<b>50.0</b>	<b>-30.0</b>	<b>50.0</b>					
104	FOG (GEU)	8.3	<b>26.3</b>	<b>24.5</b>	<b>15.4</b>	-16.2	<b>37.2</b>	<b>37.2</b>	18.0	16.2	7.1	-24.5		45.5	45.5	<b>0.0</b>	<b>45.0</b>	<b>-40.0</b>	<b>75.0</b>					
105	FOG (ICU)	8	11.1	9.1	5.1	-17.7	18.6	18.6	3.1	1.1	-2.9	-25.7		26.6	26.6	<b>0.0</b>	<b>45.0</b>	<b>-40.0</b>	<b>75.0</b>					
202	4K CAU 4K CRU EX 4K PRE- REG	8.1	<b>-2.4</b>	<b>-3.4</b>	<b>-3.5</b>	-19.3	<b>0.7</b>	<b>0.7</b>	-2.4	h	-3.4	h	-3.5	h	-19.3	h	8.8	h	8.8	h	<b>-10.0</b>	<b>40.0</b>	<b>-20.0</b>	<b>50.0</b>
203	CEU	8.7	<b>28.7</b>	<b>27.1</b>	9.8	-17.5	<b>36.9</b>	<b>36.9</b>	20.0	18.4	1.1	-17.5	h	45.6	45.6	<b>-10.0</b>	<b>40.0</b>	<b>-20.0</b>	<b>50.0</b>					
204	REU	9.3	<b>27.3</b>	<b>26.2</b>	<b>25.9</b>	-17.3	<b>30.7</b>	<b>30.7</b>	18.0	16.9	16.6	-26.6		40.0	40.0	<b>-10.0</b>	<b>40.0</b>	<b>-20.0</b>	<b>50.0</b>					
205	4K CCU Compress.1	9.2	<b>22.8</b>	<b>21.6</b>	<b>21.3</b>	-19.1	<b>26.2</b>	<b>26.2</b>	13.6	12.4	12.1	-19.1	h	35.4	35.4	<b>-10.0</b>	<b>40.0</b>	<b>-20.0</b>	<b>50.0</b>					
211	4K CCU Compress.2	11	<b>44.6</b>	<b>43.7</b>	<b>43.6</b>	-10.5	<b>47.4</b>	<b>47.4</b>	33.6	32.7	32.6	-21.5		58.4	58.4									
212	4K CCU I/F Bracket -X	10.5	<b>39.3</b>	<b>38.4</b>	<b>38.3</b>	-10.8	<b>42.1</b>	<b>42.1</b>	28.8	27.9	27.8	-21.3		52.6	52.6									
219	4K CCU I/F Bracket +X	9.1	9.8	8.9	8.8	-17.5	12.7	12.7	0.7	-0.2	-0.3	-17.5	h	21.8	21.8	<b>-10.0</b>	<b>40.0</b>	<b>-20.0</b>	<b>40.0</b>					
220	4K CCU I/F Strap -Z	8.6	3.9	3.1	3.0	-18.0	6.7	6.7	-4.7	-5.5	-5.7	-18.0	h	15.3	15.3	<b>-10.0</b>	<b>40.0</b>	<b>-20.0</b>	<b>40.0</b>					
221	4K CCU I/F Strap +Z	9.9	23.5	22.6	22.5	-13.6	26.2	26.2	13.6	12.7	12.6	-13.6	h	36.1	36.1	<b>-10.0</b>	<b>40.0</b>	<b>-20.0</b>	<b>40.0</b>					
222	SCE1	9.8	22.0	21.2	21.1	-14.2	24.8	24.8	12.2	11.4	11.3	-14.2	h	34.6	34.6	<b>-10.0</b>	<b>40.0</b>	<b>-20.0</b>	<b>40.0</b>					
401	SCE2	9.3	<b>-9.1</b>	<b>-9.1</b>	<b>-9.1</b>	-18.8	<b>-6.7</b>	-12.2	-9.1	h	-9.1	h	-9.1	h	-18.8	h	2.6	h	-2.9	h	<b>-10.0</b>	<b>40.0</b>	<b>-20.0</b>	<b>50.0</b>
402	BEU	9.3	-13.9	-14.0	-13.9	-18.4	-11.6	<b>-7.8</b>	-13.9	h	-14.0	h	-13.9	h	-18.4	h	-2.3	h	1.5	h	<b>-10.0</b>	<b>40.0</b>	<b>-20.0</b>	<b>50.0</b>
519		9.2	<b>9.6</b>	0.4	<b>3.6</b>	-12.0	<b>25.0</b>	<b>25.0</b>	0.4	-8.8	-5.7	-21.2		34.2	34.2	<b>-20.0</b>	<b>40.0</b>	<b>-30.0</b>	<b>50.0</b>					



NODE	LABEL	UFP													TEMPERATURE LIMIT			
			CASE A1	CASE A2	CASE A3	CASE C	CASE B1	CASE B2	CASE A1	CASE A2	CASE A3	CASE C	CASE B1	CASE B2	MIN	MAX	MIN	MAX
			Min	Min	Min	Min	Max	Max	Tmin - UFP	Tmin - UFP	Tmin - UFP	Tmin - UFP	Tmax +UFP	Tmax +UFP	OPER.	OPER.	N.OPE R	N.OPE R
520	BEU	9.3	<b>8.2</b>	-6.3	<b>4.2</b>	-16.9	<b>20.2</b>	<b>20.2</b>	-1.1	-15.6	-5.1	-26.2	29.5	29.5	<b>-20.0</b>	<b>40.0</b>	<b>-30.0</b>	<b>50.0</b>
521	BEU	9.2	<b>11.3</b>	0.0	<b>8.0</b>	-10.5	<b>26.7</b>	<b>26.7</b>	2.1	-9.2	-1.3	-19.7	35.9	35.9	<b>-20.0</b>	<b>40.0</b>	<b>-30.0</b>	<b>50.0</b>
522	PAU	8.6	<b>14.6</b>	<b>10.2</b>	-3.3	-13.5	<b>23.3</b>	<b>23.4</b>	6.0	1.6	-11.9	-13.5	31.9	32.0	<b>-10.0</b>	<b>30.0</b>	<b>-20.0</b>	<b>50.0</b>
525	DAE POWER BOX	8.1	<b>24.8</b>	12.7	<b>21.9</b>	1.2	<b>32.1</b>	<b>32.2</b>	16.7	4.6	13.8	-6.9	40.2	40.3	<b>-20.0</b>	<b>50.0</b>	<b>-30.0</b>	<b>50.0</b>
551	CRS3	8.5	<b>18.6</b>	<b>17.0</b>	<b>17.0</b>	<b>24.9</b>	<b>29.7</b>	<b>29.9</b>	10.1	8.5	8.5	16.4	38.2	38.4	<b>0.0</b>	<b>50.0</b>	<b>-25.0</b>	<b>55.0</b>
601	XPND_1	8.3	<b>13.3</b>	<b>11.9</b>	<b>11.9</b>	<b>17.1</b>	<b>21.3</b>	<b>21.4</b>	5.0	3.6	3.6	8.8	29.6	29.7	<b>-10.0</b>	<b>50.0</b>	<b>-20.0</b>	<b>60.0</b>
602	XPND_2	7.9	<b>3.9</b>	<b>2.4</b>	<b>2.4</b>	<b>6.5</b>	<b>11.6</b>	<b>11.7</b>	-4.0	-5.5	-5.5	-1.4	19.5	19.6	<b>-10.0</b>	<b>50.0</b>	<b>-20.0</b>	<b>60.0</b>
603	TWTA_1	8.8	-10.2	-11.8	-11.8	<b>28.4</b>	31.6	31.7	-19.0	-20.6	-20.6	19.6	40.4	40.5	<b>-20.0</b>	<b>60.0</b>	<b>-30.0</b>	<b>70.0</b>
604	TWTA_2	7.7	-11.3	-12.9	-12.8	1.0	4.5	4.6	-19.0	-20.6 (1)	-20.5	-6.7	12.2	12.3	<b>-20.0</b>	<b>60.0</b>	<b>-30.0</b>	<b>70.0</b>
605	RFDN	7.9	-0.2	-2.0	-1.9	<b>12.6</b>	17.0	17.2	-8.1	-9.9	-9.8	4.7	24.9	25.1	<b>-25.0</b>	<b>55.0</b>	<b>-35.0</b>	<b>65.0</b>
606	EPC1	8.3	<b>13.0</b>	<b>11.5</b>	<b>11.5</b>	<b>18.4</b>	<b>22.6</b>	<b>22.7</b>	4.7	3.2	3.2	10.1	30.9	31.0	<b>-20.0</b>	<b>60.0</b>	<b>-30.0</b>	<b>70.0</b>
607	EPC2	7.7	-0.9	-2.4	-2.4	4.5	8.8	8.9	-8.6	-10.1	-10.1	-3.3	16.5	16.6	<b>-20.0</b>	<b>60.0</b>	<b>-30.0</b>	<b>70.0</b>
701	CDMU	8.1	<b>15.8</b>	<b>14.2</b>	<b>14.0</b>	<b>8.3</b>	<b>20.6</b>	<b>20.6</b>	7.7	6.1	5.9	0.2	28.7	28.7	<b>-10.0</b>	<b>45.0</b>	<b>-20.0</b>	<b>55.0</b>
702	ACC	8	<b>9.3</b>	<b>7.7</b>	<b>7.6</b>	<b>1.5</b>	<b>14.0</b>	<b>14.1</b>	1.3	-0.3	-0.4	-6.5	22.0	22.1	<b>-10.0</b>	<b>45.0</b>	<b>-20.0</b>	<b>55.0</b>
703	BATT	8	<b>12.0</b>	<b>10.3</b>	<b>10.4</b>	<b>9.1</b>	<b>17.8</b>	<b>17.8</b>	4.0	2.3	2.4	1.1	25.8	25.8	<b>0.0</b>	<b>35.0</b>	N/A	N/A
704	PCDU	8.7	<b>27.8</b>	<b>26.4</b>	<b>26.5</b>	<b>17.6</b>	<b>33.3</b>	<b>33.4</b>	19.1	17.7	17.8	8.9	42.0	42.1	<b>-10.0</b>	<b>45.0</b>	<b>-20.0</b>	<b>55.0</b>
705	CRS1	8.6	<b>29.4</b>	<b>27.7</b>	<b>27.8</b>	<b>24.8</b>	<b>35.5</b>	<b>35.6</b>	20.8	19.1	19.2	16.2	44.1	44.2	<b>0.0</b>	<b>50.0</b>	<b>-25.0</b>	<b>55.0</b>
706	CRS2	8.7	<b>32.8</b>	<b>31.2</b>	<b>31.2</b>	<b>28.5</b>	<b>38.6</b>	<b>38.7</b>	24.1	22.5	22.5	19.8	47.3	47.4	<b>0.0</b>	<b>50.0</b>	<b>-25.0</b>	<b>55.0</b>
900	Helium Tank +Z	7.8	8.5	6.5	4.0	-11.7	14.8	14.9	8.5	h 6.5	h 4.0	h -11.7	h 22.6	h 22.7	<b>-10.0</b>	<b>40.0</b>	<b>-20.0</b>	<b>50.0</b>
905	Helium Tank +Y	8.3	11.7	10.3	10.2	-11.9	16.2	16.2	11.7	h 10.3	h 10.2	h -11.9	h 24.5	h 24.5	<b>-10.0</b>	<b>40.0</b>	<b>-20.0</b>	<b>50.0</b>
910	Helium Tank -Z	7.9	-9.0	-9.0	-9.0	-15.4	-6.1	-5.7	-9.0	h -9.0	h -9.0	h -15.4	h 1.9	h 2.2	<b>-10.0</b>	<b>40.0</b>	<b>-20.0</b>	<b>50.0</b>
915	Helium Tank -Y	8	8.9	7.1	7.1	10.9	18.0	18.1	0.9	-1.0	-0.9	2.9	26.0	26.1	<b>-10.0</b>	<b>40.0</b>	<b>-20.0</b>	<b>50.0</b>



Alcatel Alenia Space Italia S.p.A.

DOC. No : H-P-RP-AI-0040  
 ISSUE : 05  
 DATE : 24/FEB/06  
 PAGE : 162 of 341  
 CLASS. : DC  
 ANNEXES : ..... Pages....

NODE	LABEL	UFP	CASE A1	CASE A2	CASE A3	CASE C	CASE B1	CASE B2	CASE A1	CASE A2	CASE A3	CASE C	CASE B1	CASE B2	TEMPERATURE LIMIT									
															MIN	MAX	MIN	MAX						
															OPER.	OPER.	N.OPE R	N.OPE R						
920	Prop. Tank +Y+Z Lower	8	17.0	14.0	14.0	11.1	24.5	24.5	9.0	h	14.0	h	14.0	h	11.1	h	32.5	h	32.5	h	10.0	50.0	10.0	50.0
925	Prop. Tank -Z Lower	8.1	16.2	11.9	12.8	14.0	25.3	25.4	8.1	h	11.9	h	12.8	h	14.0	h	33.4	h	33.5	h	10.0	50.0	10.0	50.0
930	Prop. Tank -Y+Z Lower	8	16.3	13.3	13.6	17.5	23.8	23.8	8.3	h	13.3	h	13.6	h	17.5	h	31.8	h	31.8	h	10.0	50.0	10.0	50.0
311	SCC1 - Outer shell1	9.9	-11.1	-11.1	-11.1	-18.8	16.6	-11.9	-11.1	h	-11.1	h	-11.1	h	-18.8	h	16.6	h	-11.9	h				
312	SCC1 - Outer shell2	9.9	-11.1	-11.1	-11.2	-18.8	16.7	-11.9	-11.1	h	-11.1	h	-11.2	h	-18.8	h	16.7	h	-11.9	h				
313	SCC1 - Outer shell3	9.9	-11.1	-11.2	-11.1	-18.8	16.7	-11.9	-11.1	h	-11.2	h	-11.1	h	-18.8	h	16.7	h	-11.9	h				
314	SCC1 - Outer shell4	9.9	-11.1	-11.1	-11.1	-18.8	16.7	-11.9	-11.1	h	-11.1	h	-11.1	h	-18.8	h	16.7	h	-11.9	h				
315	SCC1 - Outer shell5	9.9	-11.1	-11.2	-11.2	-18.8	16.7	-11.9	-11.1	h	-11.2	h	-11.2	h	-18.8	h	16.7	h	-11.9	h				
316	SCC1 - Outer shell6	9.9	-11.1	-11.2	-11.1	-18.8	16.7	-11.9	-11.1	h	-11.2	h	-11.1	h	-18.8	h	16.7	h	-11.9	h				
811	HP11 Ver. SCC1	9.7	-11.7	-11.8	-11.8	-18.8	-5.1	-11.8	-11.7	h	-11.8	h	-11.8	h	-18.8	h	-5.1	h	-11.8	h	-13.0	7.0	-20.0	50.0
812	HP12 Ver. SCC1	9.7	-11.2	-11.2	-11.2	-18.8	-3.5	-11.8	-11.2	h	-11.2	h	-11.2	h	-18.8	h	-3.5	h	-11.8	h	-13.0	7.0	-20.0	50.0
813	HP13 Ver. SCC1	9.7	-11.2	-11.2	-11.2	-18.8	-3.5	-11.8	-11.2	h	-11.2	h	-11.2	h	-18.8	h	-3.5	h	-11.8	h	-13.0	7.0	-20.0	50.0
814	HP14 Ver. SCC1	9.7	-11.2	-11.2	-11.2	-18.8	-3.5	-11.8	-11.2	h	-11.2	h	-11.2	h	-18.8	h	-3.5	h	-11.8	h	-13.0	7.0	-20.0	50.0
815	HP15 Ver. SCC1	9.7	-11.2	-11.2	-11.2	-18.8	-3.5	-11.8	-11.2	h	-11.2	h	-11.2	h	-18.8	h	-3.5	h	-11.8	h	-13.0	7.0	-20.0	50.0
816	HP16 Ver. SCC1	9.7	-11.2	-11.2	-11.2	-18.8	-3.5	-11.8	-11.2	h	-11.2	h	-11.2	h	-18.8	h	-3.5	h	-11.8	h	-13.0	7.0	-20.0	50.0
817	HP17 Ver. SCC1	9.7	-11.2	-11.2	-11.2	-18.8	-3.5	-11.8	-11.2	h	-11.2	h	-11.2	h	-18.8	h	-3.5	h	-11.8	h	-13.0	7.0	-20.0	50.0
818	HP18 Ver. SCC1	9.7	-11.2	-11.2	-11.2	-18.8	-3.5	-11.8	-11.2	h	-11.2	h	-11.2	h	-18.8	h	-3.5	h	-11.8	h	-13.0	7.0	-20.0	50.0
819	HP19 Ver. SCC1	9.7	-11.2	-11.2	-11.2	-18.8	-3.5	-11.8	-11.2	h	-11.2	h	-11.2	h	-18.8	h	-3.5	h	-11.8	h	-13.0	7.0	-20.0	50.0
820	HP20 Ver. SCC1	9.7	-11.2	-11.2	-11.2	-18.8	-3.5	-11.8	-11.2	h	-11.2	h	-11.2	h	-18.8	h	-3.5	h	-11.8	h	-13.0	7.0	-20.0	50.0
821	HP21 Ver. SCC1	9.7	-11.2	-11.2	-11.2	-18.8	-3.5	-11.8	-11.2	h	-11.2	h	-11.2	h	-18.8	h	-3.5	h	-11.8	h	-13.0	7.0	-20.0	50.0
822	HP22 Ver. SCC1	9.7	-11.2	-11.2	-11.2	-18.8	-3.5	-11.8	-11.2	h	-11.2	h	-11.2	h	-18.8	h	-3.5	h	-11.8	h	-13.0	7.0	-20.0	50.0
823	HP23 Ver. SCC1	9.7	-11.2	-11.2	-11.2	-18.8	-3.5	-11.8	-11.2	h	-11.2	h	-11.2	h	-18.8	h	-3.5	h	-11.8	h	-13.0	7.0	-20.0	50.0
824	HP24 Ver. SCC1	9.7	-11.2	-11.2	-11.2	-18.8	-3.5	-11.8	-11.2	h	-11.2	h	-11.2	h	-18.8	h	-3.5	h	-11.8	h	-13.0	7.0	-20.0	50.0



Alcatel Alenia Space Italia S.p.A.

DOC. No : H-P-RP-AI-0040  
 ISSUE : 05  
 DATE : 24/FEB/06  
 PAGE : 163 of 341  
 CLASS. : DC  
 ANNEXES : ..... Pages....

NODE	LABEL	UFP	CASE A1	CASE A2	CASE A3	CASE C	CASE B1	CASE B2	CASE A1	CASE A2	CASE A3	CASE C	CASE B1	CASE B2	TEMPERATURE LIMIT									
															MIN	MAX	MIN	MAX						
															OPER.	OPER.	N.OPE R	N.OPE R						
825	HP25 Ver. SCC1	9.7	-11.2	-11.2	-11.2	-18.8	-3.5	-11.8	-11.2	h	-11.2	h	-11.2	h	-18.8	h	-3.5	h	-11.8	h	-13.0	7.0	-20.0	50.0
826	HP26 Ver. SCC1	9.7	-11.7	-11.8	-11.8	-18.8	-5.1	-11.8	-11.7	h	-11.8	h	-11.8	h	-18.8	h	-5.1	h	-11.8	h	-13.0	7.0	-20.0	50.0
801	HP1 Hor. SCC1	9.3	-14.2	-14.3	-14.3	-19.1	-10.4	-11.8	-14.2	h	-14.3	h	-14.3	h	-19.1	h	-10.4	h	-11.8	h				
802	HP2 Hor. SCC1	9.3	-12.1	-12.2	-12.2	-18.7	-9.4	-11.7	-12.1	h	-12.2	h	-12.2	h	-18.7	h	-9.4	h	-11.7	h				
803	HP3 Hor. SCC1	9.3	-13.0	-13.1	-13.1	-18.9	-9.7	-12.4	-13.0	h	-13.1	h	-13.1	h	-18.9	h	-9.7	h	-12.4	h				
804	HP4 Hor. SCC1	9.3	-13.1	-13.2	-13.2	-19.2	-9.8	-12.5	-13.1	h	-13.2	h	-13.2	h	-19.2	h	-9.8	h	-12.5	h				
805	HP5 Hor. SCC1	9.3	-14.0	-14.0	-14.0	-19.0	-11.1	-11.9	-14.0	h	-14.0	h	-14.0	h	-19.0	h	-11.1	h	-11.9	h				
806	HP6 Hor. SCC1	9.3	-14.7	-14.8	-14.8	-18.6	-11.4	-11.0	-14.7	h	-14.8	h	-14.8	h	-18.6	h	-11.4	h	-11.0	h				
807	HP7 Hor. SCC1	9.3	-14.7	-14.7	-14.7	-18.8	-11.4	-10.9	-14.7	h	-14.7	h	-14.7	h	-18.8	h	-11.4	h	-10.9	h				
808	HP7 Hor. SCC1	9.3	-14.0	-14.0	-14.0	-18.3	-11.3	-10.5	-14.0	h	-14.0	h	-14.0	h	-18.3	h	-11.3	h	-10.5	h				
511	SCC2 - Outer shell1	9.1	-15.6	-15.6	-15.6	-17.9	-13.8	<b>18.6</b>	-15.6	h	-15.6	h	-15.6	h	-17.9	h	-13.8	h	18.6	h				
512	SCC2 - Outer shell2	9.1	-15.6	-15.6	-15.6	-17.9	-13.8	<b>18.6</b>	-15.6	h	-15.6	h	-15.6	h	-17.9	h	-13.8	h	18.6	h				
513	SCC2 - Outer shell3	9.1	-15.6	-15.6	-15.6	-17.9	-13.8	<b>18.6</b>	-15.6	h	-15.6	h	-15.6	h	-17.9	h	-13.8	h	18.6	h				
514	SCC2 - Outer shell4	9.1	-15.6	-15.6	-15.6	-17.9	-13.8	<b>18.6</b>	-15.6	h	-15.6	h	-15.6	h	-17.9	h	-13.8	h	18.6	h				
515	SCC2 - Outer shell5	9.1	-15.6	-15.6	-15.6	-17.9	-13.8	<b>18.6</b>	-15.6	h	-15.6	h	-15.6	h	-17.9	h	-13.8	h	18.6	h				
516	SCC2 - Outer shell6	9.1	-15.6	-15.6	-15.6	-17.9	-13.8	<b>18.6</b>	-15.6	h	-15.6	h	-15.6	h	-17.9	h	-13.8	h	18.6	h				
861	HP61 Ver. SCC2	9.7	-15.7	-15.7	-15.7	-17.9	-13.8	-2.8	-15.7	h	-15.7	h	-15.7	h	-17.9	h	-13.8	h	-2.8	h	-13.0	7.0	-20.0	50.0
862	HP62 Ver. SCC2	9.7	-15.6	-15.6	-15.6	-17.9	-13.8	-1.2	-15.6	h	-15.6	h	-15.6	h	-17.9	h	-13.8	h	-1.2	h	-13.0	7.0	-20.0	50.0
863	HP63 Ver. SCC2	9.7	-15.6	-15.6	-15.6	-17.9	-13.8	-1.2	-15.6	h	-15.6	h	-15.6	h	-17.9	h	-13.8	h	-1.2	h	-13.0	7.0	-20.0	50.0
864	HP64 Ver. SCC2	9.7	-15.6	-15.6	-15.6	-17.9	-13.8	-1.2	-15.6	h	-15.6	h	-15.6	h	-17.9	h	-13.8	h	-1.2	h	-13.0	7.0	-20.0	50.0
865	HP65 Ver. SCC2	9.7	-15.6	-15.6	-15.6	-17.9	-13.8	-1.2	-15.6	h	-15.6	h	-15.6	h	-17.9	h	-13.8	h	-1.2	h	-13.0	7.0	-20.0	50.0
866	HP66 Ver. SCC2	9.7	-15.6	-15.6	-15.6	-17.9	-13.8	-1.2	-15.6	h	-15.6	h	-15.6	h	-17.9	h	-13.8	h	-1.2	h	-13.0	7.0	-20.0	50.0
867	HP67 Ver. SCC2	9.7	-15.6	-15.6	-15.6	-17.9	-13.8	-1.2	-15.6	h	-15.6	h	-15.6	h	-17.9	h	-13.8	h	-1.2	h	-13.0	7.0	-20.0	50.0



Alcatel Alenia Space Italia S.p.A.

DOC. No : H-P-RP-AI-0040  
 ISSUE : 05  
 DATE : 24/FEB/06  
 PAGE : 164 of 341  
 CLASS. : DC  
 ANNEXES : ..... Pages....

NODE	LABEL	UFP															TEMPERATURE LIMIT							
			CASE A1	CASE A2	CASE A3	CASE C	CASE B1	CASE B2	CASE A1	CASE A2	CASE A3	CASE C	CASE B1	CASE B2	MIN	MAX	MIN	MAX						
			Min	Min	Min	Min	Max	Max	Tmin - UFP	Tmin - UFP	Tmin - UFP	Tmin - UFP	Tmax +UFP	Tmax +UFP	OPER.	OPER.	N.OPE R	N.OPE R						
868	HP68 Ver. SCC2	9.7	-15.6	-15.6	-15.6	-17.9	-13.8	-1.2	-15.6	h	-15.6	h	-15.6	h	-17.9	h	-13.8	h	-1.2	h	<b>-13.0</b>	<b>7.0</b>	<b>-20.0</b>	<b>50.0</b>
869	HP69 Ver. SCC2	9.7	-15.6	-15.6	-15.6	-17.9	-13.8	-1.2	-15.6	h	-15.6	h	-15.6	h	-17.9	h	-13.8	h	-1.2	h	<b>-13.0</b>	<b>7.0</b>	<b>-20.0</b>	<b>50.0</b>
870	HP70 Ver. SCC2	9.7	-15.6	-15.6	-15.6	-17.9	-13.8	-1.2	-15.6	h	-15.6	h	-15.6	h	-17.9	h	-13.8	h	-1.2	h	<b>-13.0</b>	<b>7.0</b>	<b>-20.0</b>	<b>50.0</b>
871	HP71 Ver. SCC2	9.7	-15.6	-15.6	-15.6	-17.9	-13.8	-1.2	-15.6	h	-15.6	h	-15.6	h	-17.9	h	-13.8	h	-1.2	h	<b>-13.0</b>	<b>7.0</b>	<b>-20.0</b>	<b>50.0</b>
872	HP72 Ver. SCC2	9.7	-15.6	-15.6	-15.6	-17.9	-13.8	-1.2	-15.6	h	-15.6	h	-15.6	h	-17.9	h	-13.8	h	-1.2	h	<b>-13.0</b>	<b>7.0</b>	<b>-20.0</b>	<b>50.0</b>
873	HP73 Ver. SCC2	9.7	-15.6	-15.6	-15.6	-17.9	-13.8	-1.2	-15.6	h	-15.6	h	-15.6	h	-17.9	h	-13.8	h	-1.2	h	<b>-13.0</b>	<b>7.0</b>	<b>-20.0</b>	<b>50.0</b>
874	HP74 Ver. SCC2	9.7	-15.6	-15.6	-15.6	-17.9	-13.8	-1.2	-15.6	h	-15.6	h	-15.6	h	-17.9	h	-13.8	h	-1.2	h	<b>-13.0</b>	<b>7.0</b>	<b>-20.0</b>	<b>50.0</b>
875	HP75 Ver. SCC2	9.7	-15.6	-15.6	-15.6	-17.9	-13.8	-1.2	-15.6	h	-15.6	h	-15.6	h	-17.9	h	-13.8	h	-1.2	h	<b>-13.0</b>	<b>7.0</b>	<b>-20.0</b>	<b>50.0</b>
876	HP76 Ver. SCC2	9.7	-15.7	-15.7	-15.7	-17.9	-13.8	-2.8	-15.7	h	-15.7	h	-15.7	h	-17.9	h	-13.8	h	-2.8	h	<b>-13.0</b>	<b>7.0</b>	<b>-20.0</b>	<b>50.0</b>
851	HP51 Hor. SCC2	9.1	-15.7	-15.7	-15.7	-17.1	-13.3	-7.7	-15.7	h	-15.7	h	-15.7	h	-17.1	h	-13.3	h	-7.7	h				
852	HP52 Hor. SCC2	9.1	-15.1	-15.1	-15.1	-17.8	-13.1	-7.9	-15.1	h	-15.1	h	-15.1	h	-17.8	h	-13.1	h	-7.9	h				
853	HP53 Hor. SCC2	9.1	-15.6	-15.6	-15.6	-18.3	-13.4	-8.2	-15.6	h	-15.6	h	-15.6	h	-18.3	h	-13.4	h	-8.2	h				
854	HP54 Hor. SCC2	9.1	-15.7	-15.7	-15.7	-18.5	-13.5	-8.3	-15.7	h	-15.7	h	-15.7	h	-18.5	h	-13.5	h	-8.3	h				
855	HP55 Hor. SCC2	9.1	-16.0	-16.0	-16.0	-17.5	-14.0	-8.3	-16.0	h	-16.0	h	-16.0	h	-17.5	h	-14.0	h	-8.3	h				
856	HP56 Hor. SCC2	9.1	-16.3	-16.3	-16.3	-18.9	-14.1	-7.8	-16.3	h	-16.3	h	-16.3	h	-18.9	h	-14.1	h	-7.8	h				
857	HP57 Hor. SCC2	9.1	-16.3	-16.3	-16.3	-18.1	-14.1	-7.8	-16.3	h	-16.3	h	-16.3	h	-18.1	h	-14.1	h	-7.8	h				
858	HP57 Hor. SCC2	9.1	-16.0	-16.0	-16.0	-17.9	-14.0	-7.7	-16.0	h	-16.0	h	-16.0	h	-17.9	h	-14.0	h	-7.7	h				
3931	SAS1 HOUSING	9.2	8.4	7.4	7.2	-26.7	11.3	11.4	-0.8		-1.8		-2.0		-35.9		20.5		20.6		<b>-70.0</b>	<b>80.0</b>	<b>-80.0</b>	<b>90.0</b>
3951	SAS2 HOUSING	7.5	50.0	48.3	47.8	40.6	60.3	60.4	42.5		40.8		40.3		33.1		67.8		67.9		<b>-70.0</b>	<b>80.0</b>	<b>-80.0</b>	<b>90.0</b>
3921	LGA+Y HORN	8.3	-45.1	-45.6	-45.8	<b>-32.4</b>	-43.3	-43.2	-53.4		-53.9		-54.1		-40.7		-35.0		-34.9		<b>-150.0</b>	<b>120.0</b>	<b>-150.0</b>	<b>120.0</b>
3961	LGA-Y HORN	8.2	-60.9	-61.8	-61.7	<b>-28.9</b>	-55.2	-55.1	-69.1		-70.0		-69.9		-37.1		-47.0		-46.9		<b>-150.0</b>	<b>120.0</b>	<b>-150.0</b>	<b>120.0</b>
3991	LGA-X HORN	7.2	61.3	60.3	60.3	57.7	69.9	69.9	54.1		53.1		53.1		50.5		77.1		77.1		<b>-150.0</b>	<b>120.0</b>	<b>-150.0</b>	<b>120.0</b>
3986	MGA-X SEPTUM	8.5	30.7	28.2	28.1	21.3	51.3	51.3	22.2		19.7		19.6		12.8		59.8		59.8		<b>-150.0</b>	<b>150.0</b>	<b>-150.0</b>	<b>150.0</b>

NODE	LABEL	UFP	CASE A1	CASE A2	CASE A3	CASE C	CASE B1	CASE B2	CASE A1	CASE A2	CASE A3	CASE C	CASE B1	CASE B2	TEMPERATURE LIMIT			
															MIN	MAX	MIN	MAX
															OPER.	OPER.	N.OPE R	N.OPE R
3966	SREM	8.2	<b>16.7</b>	<b>14.8</b>	<b>13.2</b>	-17.6	<b>22.6</b>	<b>22.7</b>	8.5	6.6	5.0	-25.8	30.8	30.9	<b>-10.0</b>	<b>50.0</b>	<b>-45.0</b>	<b>90.0</b>
3970	AAD_HOUSING	8.8	40.8	38.9	38.4	30.5	50.3	50.4	32.0	30.1	29.6	21.7	59.1	59.2	<b>-70.0</b>	<b>70.0</b>	<b>-80.0</b>	<b>80.0</b>
8508	1FCV BODY	7.9	14.0	14.0	13.9	13.9	15.6	15.6	14.0 h	14.0 h	13.9 h	13.9 h	23.5 h	23.5 h	<b>10.0</b>	<b>60.0</b>	<b>10.0</b>	<b>70.0</b>
8608	1FCV BODY	7.8	14.0	13.9	13.9	13.9	17.1	17.1	14.0 h	13.9 h	13.9 h	13.9 h	17.1 h	24.9 h	<b>10.0</b>	<b>60.0</b>	<b>10.0</b>	<b>70.0</b>
8708	1FCV BODY	8	14.2	14.1	14.1	14.0	20.0	20.1	14.2 h	14.1 h	14.1 h	14.0 h	28.0 h	28.1 h	<b>10.0</b>	<b>60.0</b>	<b>10.0</b>	<b>70.0</b>
8808	1FCV BODY	8	14.0	14.0	14.0	14.0	19.8	19.9	14.0 h	14.0 h	14.0 h	14.0 h	27.8 h	27.9 h	<b>10.0</b>	<b>60.0</b>	<b>10.0</b>	<b>70.0</b>
1133	FCV BODY MAIN FCV BODY	7.8	34.2	32.8	32.0	28.5	35.6	35.6	34.2 h	32.8 h	32.0 h	28.5 h	43.4 h	43.4 h	<b>10.0</b>	<b>60.0</b>	<b>10.0</b>	<b>70.0</b>
1134	REDUNDANT	7.9	32.6	31.2	30.4	23.3	34.7	34.7	32.6 h	31.2 h	30.4 h	23.3 h	42.6 h	42.6 h	<b>10.0</b>	<b>60.0</b>	<b>10.0</b>	<b>70.0</b>
1233	FCV BODY MAIN FCV BODY	7.6	29.8	29.6	29.6	36.4	33.1	32.6	29.8 h	29.6 h	29.6 h	36.4 h	40.7 h	40.2 h	<b>10.0</b>	<b>60.0</b>	<b>10.0</b>	<b>70.0</b>
1234	REDUNDANT	7.7	29.3	29.2	29.1	29.9	33.1	32.6	29.3 h	29.2 h	29.1 h	29.9 h	40.8 h	40.3 h	<b>10.0</b>	<b>60.0</b>	<b>10.0</b>	<b>70.0</b>
1333	FCV BODY MAIN FCV BODY	7.9	28.2	27.0	27.0	34.8	33.5	33.6	28.2 h	27.0 h	27.0 h	34.8 h	41.4 h	41.5 h	<b>10.0</b>	<b>60.0</b>	<b>10.0</b>	<b>70.0</b>
1334	REDUNDANT	8	29.4	28.1	28.2	29.9	33.4	33.5	29.4 h	28.1 h	28.2 h	29.9 h	41.4 h	41.5 h	<b>10.0</b>	<b>60.0</b>	<b>10.0</b>	<b>70.0</b>
1433	FCV BODY MAIN FCV BODY	8.1	30.2	28.9	24.9	17.8	34.1	34.1	30.2 h	28.9 h	24.9 h	17.8 h	42.2 h	42.2 h	<b>10.0</b>	<b>60.0</b>	<b>10.0</b>	<b>70.0</b>
1434	REDUNDANT	7.9	29.3	28.0	24.0	14.0	34.0	34.0	29.3 h	28.0 h	24.0 h	14.0 h	41.9 h	41.9 h	<b>10.0</b>	<b>60.0</b>	<b>10.0</b>	<b>70.0</b>
1533	FCV BODY MAIN FCV BODY	9.2	20.1	19.2	19.2	21.4	22.8	22.8	20.1 h	19.2 h	19.2 h	21.4 h	32.0 h	32.0 h	<b>10.0</b>	<b>60.0</b>	<b>10.0</b>	<b>70.0</b>
1534	REDUNDANT	9.3	19.9	19.0	18.9	14.0	22.6	22.6	19.9 h	19.0 h	18.9 h	14.0 h	31.9 h	31.9 h	<b>10.0</b>	<b>60.0</b>	<b>10.0</b>	<b>70.0</b>
1733	FCV BODY MAIN FCV BODY	8.8	14.7	14.0	14.0	36.6	20.8	21.0	14.7 h	14.0 h	14.0 h	36.6 h	29.6 h	29.8 h	<b>10.0</b>	<b>60.0</b>	<b>10.0</b>	<b>70.0</b>
1734	REDUNDANT	8.8	14.9	14.0	14.0	24.1	21.0	21.2	14.9 h	14.0 h	14.0 h	24.1 h	29.8 h	30.0 h	<b>10.0</b>	<b>60.0</b>	<b>10.0</b>	<b>70.0</b>
8001	Solar Array vs. space -X	8	108.6	108.5	108.5	109.3	118.1	118.1	100.6	100.5	100.5	101.3	126.1	126.1				



Alcatel Alenia Space Italia S.p.A.

DOC. No : H-P-RP-AI-0040  
 ISSUE : 05  
 DATE : 24/FEB/06  
 PAGE : 166 of 341  
 CLASS. : DC  
 ANNEXES : ..... Pages....

NODE	LABEL	UFP	CASE A1	CASE A2	CASE A3	CASE C	CASE B1	CASE B2	CASE A1	CASE A2	CASE A3	CASE C	CASE B1	CASE B2	TEMPERATURE LIMIT			
															MIN	MAX	MIN	MAX
															OPER.	OPER.	N.OPE R	N.OPE R
			Min	Min	Min	Min	Max	Max	Tmin - UFP	Tmin - UFP	Tmin - UFP	Tmin - UFP	Tmax +UFP	Tmax +UFP				
8002	Solar Array vs. space-X	7.5	106.6	106.7	106.6	108.2	118.4	118.4	99.1	99.2	99.1	100.7	125.9	125.9				
8003	Solar Array vs. space -X	8.4	107.2	107.0	107.2	108.5	117.7	117.7	98.8	98.6	98.8	100.1	126.1	126.1				
8004	Solar Array vs. space -X	8.1	108.0	108.4	108.0	109.0	117.8	117.8	99.9	100.3	99.9	100.9	125.9	125.9				
8051	Solar Array vs. space -X	8	108.3	108.3	108.3	109.0	117.8	117.8	100.3	100.3	100.3	101.0	125.8	125.8				
8052	Solar Array vs. space +X	7.6	106.4	106.5	106.4	108.0	118.1	118.1	98.8	98.9	98.8	100.4	125.7	125.7				
8053	Solar Array vs. space +X	8.4	107.0	106.7	106.9	108.3	117.5	117.5	98.6	98.3	98.5	99.9	125.9	125.9				
8054	Solar Array vs. space +X	8.1	107.7	108.2	107.7	108.8	117.6	117.6	99.6	100.1	99.6	100.7	125.7	125.7				
8301	Central Solar Array -X	7.9	114.8	114.8	114.8	115.9	121.9	121.9	106.9	106.9	106.9	108.0	129.8	129.8				
8302	Central Solar Array -X	8	114.6	114.5	114.6	115.6	121.4	121.4	106.6	106.5	106.6	107.6	129.4	129.4				
8303	Central Solar Array -X	8.1	114.2	114.6	114.2	115.3	120.8	120.8	106.1	106.5	106.1	107.2	128.9	128.9				
8304	Central Solar Array -X	7.9	114.7	114.9	114.7	115.9	121.5	121.5	106.8	107.0	106.8	108.0	129.4	129.4				
8351	Central Solar Array +X	7.9	114.6	114.6	114.6	115.7	121.7	121.7	106.7	106.7	106.7	107.8	129.6	129.6				
8352	Central Solar Array +X	8	114.4	114.3	114.3	115.4	121.2	121.2	106.4	106.3	106.3	107.4	129.2	129.2				
8353	Central Solar Array +X	8.1	114.0	114.3	114.0	115.0	120.6	120.6	105.9	106.2	105.9	106.9	128.7	128.7				
8354	Central Solar Array +X	7.9	114.5	114.7	114.4	115.7	121.3	121.3	106.6	106.8	106.5	107.8	129.2	129.2				
8101	MLI Solar Array vs. sate	27.7	8.0	7.8	7.6	4.7	11.0	11.0	-19.8	-19.9	-20.1	-23.0	38.7	38.7				
8102	MLI Solar Array vs. sate	26.9	6.0	5.9	5.9	5.7	13.1	13.0	-20.9	-21.0	-21.0	-21.2	40.0	39.9				
8103	MLI Solar Array vs. sate	27.2	5.4	5.3	5.3	6.1	12.1	12.3	-21.8	-21.9	-21.9	-21.1	39.3	39.5				
8104	MLI Solar Array vs. sate	27.3	7.7	7.5	7.5	6.1	11.0	11.0	-19.6	-19.8	-19.8	-21.2	38.3	38.3				
1801	RCS Piping - Line 4	8	30.79	30.71	30.04	19.72	34.47	34.46	22.8 h	22.7 h	22.0 h	11.7 h	42.5 h	42.5 h	<b>10.0</b>	<b>50.0</b>		
1802	RCS Piping - Line 5	8	35.94	35.51	35.37	19.45	39.88	39.81	27.9 h	27.5 h	27.4 h	11.5 h	47.9 h	47.8 h	<b>10.0</b>	<b>50.0</b>		
1803	RCS Piping - Line 5	8	30.47	30.54	30.58	21.1	31.21	31.2	22.5 h	22.5 h	22.6 h	13.1 h	39.2 h	39.2 h	<b>10.0</b>	<b>50.0</b>		
1804	RCS Piping - Line 4	8	35.26	36.2	35.45	23.35	36.54	36.51	27.3 h	28.2 h	27.5 h	15.4 h	44.5 h	44.5 h	<b>10.0</b>	<b>50.0</b>		



Alcatel Alenia Space Italia S.p.A.

DOC. No : H-P-RP-AI-0040  
 ISSUE : 05  
 DATE : 24/FEB/06  
 PAGE : 167 of 341  
 CLASS. : DC  
 ANNEXES : ..... Pages....

NODE	LABEL	UFP	CASE A1	CASE A2	CASE A3	CASE C	CASE B1	CASE B2	CASE A1	CASE A2	CASE A3	CASE C	CASE B1	CASE B2	TEMPERATURE LIMIT			
															MIN	MAX	MIN	MAX
															OPER.	OPER.	N.OPE R	N.OPE R
			Min	Min	Min	Min	Max	Max	Tmin - UFP	Tmin - UFP	Tmin - UFP	Tmin - UFP	Tmax +UFP	Tmax +UFP				
1805	RCS Piping - Line 3	8	27.98	27.97	27.97	19.95	29.04	29.04	20.0 h	20.0 h	20.0 h	12.0 h	37.0 h	37.0 h	10.0	50.0		
1806	RCS Piping - Line 2	8	35.78	36.35	36.2	26.5	36.38	36.37	27.8 h	28.4 h	28.2 h	18.5 h	44.4 h	44.4 h	10.0	50.0		
1809	RCS Piping - Line 2	8	31.96	31.96	31.95	20.94	33.08	33.08	24.0 h	24.0 h	24.0 h	12.9 h	41.1 h	41.1 h	10.0	50.0		
1810	RCS Piping - Line 6	8	22.84	20.97	21.69	19.03	28.23	28.28	14.8 h	13.0 h	13.7 h	11.0 h	36.2 h	36.3 h	10.0	50.0		
1811	RCS Piping - Line 6	8	24.38	22.72	23.41	21.67	30.55	30.59	16.4 h	14.7 h	15.4 h	13.7 h	38.6 h	38.6 h	10.0	50.0		
1812	RCS Piping - Line 6	8	24.02	22.27	23.18	21.69	28.84	28.89	16.0 h	14.3 h	15.2 h	13.7 h	36.8 h	36.9 h	10.0	50.0		
1813	RCS Piping - Line 6	8	26.88	25.3	26.53	26.86	30.84	30.88	18.9 h	17.3 h	18.5 h	18.9 h	38.8 h	38.9 h	10.0	50.0		
1814	RCS Piping - Line 4	8	36.33	35.96	36.78	22.27	36.29	36.28	28.3 h	28.0 h	28.8 h	14.3 h	44.3 h	44.3 h	10.0	50.0		
1815	RCS Piping - Line 4	8	34.95	34.93	34.93	21.98	36.05	36.05	27.0 h	26.9 h	26.9 h	14.0 h	44.1 h	44.1 h	10.0	50.0		
1816	RCS Piping - Line 4	8	34.62	35.22	34.47	23.21	36.25	36.23	26.6 h	27.2 h	26.5 h	15.2 h	44.3 h	44.2 h	10.0	50.0		
1817	RCS Piping - Line 3	8	29.1	29.64	29.63	26.39	30.8	30.79	21.1 h	21.6 h	21.6 h	18.4 h	38.8 h	38.8 h	10.0	50.0		
1818	RCS Piping - Line 5	8	19.36	20.81	20.82	22.31	22.04	22.18	11.4 h	12.8 h	12.8 h	14.3 h	30.0 h	30.2 h	10.0	50.0		
1819	RCS Piping - Line 6	8	26.35	25.02	25.34	24.22	31.17	31.2	18.4 h	17.0 h	17.3 h	16.2 h	39.2 h	39.2 h	10.0	50.0		
1820	RCS Piping - Line 2	8	36.41	37.04	36.95	28.64	38.12	38.1	28.4 h	29.0 h	29.0 h	20.6 h	46.1 h	46.1 h	10.0	50.0		
1821	RCS Piping - Line 3	8	27.23	29.91	29.69	28.15	23.14	23.07	19.2 h	21.9 h	21.7 h	20.2 h	31.1 h	31.1 h	10.0	50.0		
1822	RCS Piping - Line 3	8	31.9	34.22	34.01	28.17	27.78	27.73	23.9 h	26.2 h	26.0 h	20.2 h	35.8 h	35.7 h	10.0	50.0		
1823	RCS Piping - Line 2	8	32.12	32.34	32.12	21.22	36.01	36.02	24.1 h	24.3 h	24.1 h	13.2 h	44.0 h	44.0 h	10.0	50.0		
1831	RCS Piping - Line 4	8	29.33	37.32	34.41	25.4	19.07	18.54	21.3 h	29.3 h	26.4 h	17.4 h	27.1 h	26.5 h	10.0	50.0		
1832	RCS Piping - Line 4	8	28	31.65	30.26	26.65	25.58	25.14	20.0 h	23.7 h	22.3 h	18.7 h	33.6 h	33.1 h	10.0	50.0		
1841	RCS Piping - Line 5	8	22.85	23.2	23.22	23.07	24.76	24.8	14.9 h	15.2 h	15.2 h	15.1 h	32.8 h	32.8 h	10.0	50.0		
1842	RCS Piping - Line 5	8	24.23	25.27	25.29	26.09	24.43	24.46	16.2 h	17.3 h	17.3 h	18.1 h	32.4 h	32.5 h	10.0	50.0		
1843	RCS Piping - Line 5	8	19.88	21.44	21.45	22.66	22.36	22.49	11.9 h	13.4 h	13.5 h	14.7 h	30.4 h	30.5 h	10.0	50.0		
1850	PT - Line 1	8	19	18.99	18.99	18.94	21.35	21.38	11.0 h	11.0 h	11.0 h	10.9 h	29.4 h	29.4 h	10.0	50.0		



Alcatel Alenia Space Italia S.p.A.

DOC. No : H-P-RP-AI-0040  
 ISSUE : 05  
 DATE : 24/FEB/06  
 PAGE : 168 of 341  
 CLASS. : DC  
 ANNEXES : ..... Pages....

NODE	LABEL	UFP	CASE A1	CASE A2	CASE A3	CASE C	CASE B1	CASE B2	CASE A1	CASE A2	CASE A3	CASE C	CASE B1	CASE B2	TEMPERATURE LIMIT			
															MIN	MAX	MIN	MAX
															OPER.	OPER.	N.OPE R	N.OPE R
1851	LV1 - Line 1	8	19.92	19.83	20.07	24.23	22.32	22.34	11.9 h	11.8 h	12.1 h	16.2 h	30.3 h	30.3 h	10.0	50.0		
1852	LV2 - Line 1	8	19.92	19.82	20.05	24.02	22.34	22.37	11.9 h	11.8 h	12.1 h	16.0 h	30.3 h	30.4 h	10.0	50.0		
1853	LF - Line 1	8	19.85	19.72	19.95	23.04	22.37	22.4	11.9 h	11.7 h	12.0 h	15.0 h	30.4 h	30.4 h	10.0	50.0		
1854	RCS Piping - Line 3	8	31.8	33.43	32.44	20.32	28.58	28.55	23.8 h	25.4 h	24.4 h	12.3 h	36.6 h	36.6 h	10.0	50.0		
1855	RCS Piping - Line 3	8	31.53	32.89	32.04	22.39	30.15	30.12	23.5 h	24.9 h	24.0 h	14.4 h	38.2 h	38.1 h	10.0	50.0		
1856	RCS Piping - Line 3	8	31.04	32.59	31.63	19.69	28.34	28.31	23.0 h	24.6 h	23.6 h	11.7 h	36.3 h	36.3 h	10.0	50.0		
1857	RCS Piping - Line 3	8	29.36	30.97	30.65	21.04	28.82	28.79	21.4 h	23.0 h	22.7 h	13.0 h	36.8 h	36.8 h	10.0	50.0		
1859	RCS Piping - Line 3	8	30.6	31.85	31.1	22.75	29.33	29.3	22.6 h	23.9 h	23.1 h	14.8 h	37.3 h	37.3 h	10.0	50.0		
1860	RCS Piping - Line 4	8	41.92	44.54	42.96	31.96	40.99	40.91	33.9 h	36.5 h	35.0 h	24.0 h	49.0 h	48.9 h	10.0	50.0		
1861	RCS Piping - Line 4	8	39.77	41.8	40.69	28.31	39.17	39.11	31.8 h	33.8 h	32.7 h	20.3 h	47.2 h	47.1 h	10.0	50.0		
1862	RCS Piping - Line 3	8	31.19	31.78	31.74	26.87	32.87	32.85	23.2 h	23.8 h	23.7 h	18.9 h	40.9 h	40.9 h	10.0	50.0		
1863	RCS Piping - Line 5	8	36.29	35.88	35.72	19.66	39.68	39.61	28.3 h	27.9 h	27.7 h	11.7 h	47.7 h	47.6 h	10.0	50.0		
1864	RCS Piping - Line 4	8	28.22	27.83	27.85	20.93	31.6	31.62	20.2 h	19.8 h	19.9 h	12.9 h	39.6 h	39.6 h	10.0	50.0		
1865	RCS Piping - Line 6	8	25.22	23.46	23.62	19.52	29.94	29.96	17.2 h	15.5 h	15.6 h	11.5 h	37.9 h	38.0 h	10.0	50.0		
1866	RCS Piping - Line 6	8	23.88	22.14	22.93	21.07	28.8	28.85	15.9 h	14.1 h	14.9 h	13.1 h	36.8 h	36.9 h	10.0	50.0		
1867	RCS Piping - Line 5	8	28.96	28.62	28.65	19.98	30.02	30.02	21.0 h	20.6 h	20.7 h	12.0 h	38.0 h	38.0 h	10.0	50.0		
1868	RCS Piping - Line 2	8	32.26	32.24	31.89	20.45	33.82	33.82	24.3 h	24.2 h	23.9 h	12.5 h	41.8 h	41.8 h	10.0	50.0		
1869	RCS Piping - Line 3	8	29.43	29.76	29.74	22.97	29.72	29.72	21.4 h	21.8 h	21.7 h	15.0 h	37.7 h	37.7 h	10.0	50.0		
1870	RCS Piping - Line 5	8	28.78	29.17	29.2	22.12	28.07	28.04	20.8 h	21.2 h	21.2 h	14.1 h	36.1 h	36.0 h	10.0	50.0		
1871	RCS Piping - Line 5	8	29.97	30.74	30.75	23.16	30.07	30.03	22.0 h	22.7 h	22.8 h	15.2 h	38.1 h	38.0 h	10.0	50.0		
1872	RCS Piping - Line 5	8	28.42	29.35	29.35	22.29	28.72	28.68	20.4 h	21.4 h	21.4 h	14.3 h	36.7 h	36.7 h	10.0	50.0		
1873	RCS Piping - Line 5	8	28.59	28.91	28.93	22.29	29.87	29.86	20.6 h	20.9 h	20.9 h	14.3 h	37.9 h	37.9 h	10.0	50.0		
1874	RCS Piping - Line 5	8	30.97	31.54	31.57	24.58	32.05	32.03	23.0 h	23.5 h	23.6 h	16.6 h	40.1 h	40.0 h	10.0	50.0		



NODE	LABEL	UFP													TEMPERATURE LIMIT									
			CASE A1	CASE A2	CASE A3	CASE C	CASE B1	CASE B2	CASE A1	CASE A2	CASE A3	CASE C	CASE B1	CASE B2	MIN	MAX	MIN	MAX						
			Min	Min	Min	Min	Max	Max	Tmin - UFP	Tmin - UFP	Tmin - UFP	Tmin - UFP	Tmax +UFP	Tmax +UFP	OPER.	OPER.	N.OPE R	N.OPE R						
1875	RCS Piping - Line 5	8	29.42	30.3	30.31	26.52	29.69	29.67	21.4	h	22.3	h	22.3	h	18.5	h	37.7	h	37.7	h	<b>10.0</b>	<b>50.0</b>		
1876	RCS Piping - Line 5	8	28.13	28.89	28.89	25.71	30.01	30	20.1	h	20.9	h	20.9	h	17.7	h	38.0	h	38.0	h	<b>10.0</b>	<b>50.0</b>		
1877	RCS Piping - Line 5	8	28.13	28.89	28.89	25.71	30.01	30	20.1	h	20.9	h	20.9	h	17.7	h	38.0	h	38.0	h	<b>10.0</b>	<b>50.0</b>		
1878	RCS Piping - Line 5	8	26.93	27.5	27.49	24.7	29.09	29.08	18.9	h	19.5	h	19.5	h	16.7	h	37.1	h	37.1	h	<b>10.0</b>	<b>50.0</b>		
1879	RCS Piping - Line 5	8	26.93	27.5	27.49	24.7	29.09	29.08	18.9	h	19.5	h	19.5	h	16.7	h	37.1	h	37.1	h	<b>10.0</b>	<b>50.0</b>		
1881	RCS Piping - Line 6	8	24.21	23.45	23.62	23.64	27.05	27.09	16.2	h	15.5	h	15.6	h	15.6	h	35.1	h	35.1	h	<b>10.0</b>	<b>50.0</b>		
1882	RCS Piping - Line 6	8	20.68	20.04	20.32	20.85	23.14	23.17	12.7	h	12.0	h	12.3	h	12.9	h	31.1	h	31.2	h	<b>10.0</b>	<b>50.0</b>		
1883	RCS Piping - Line 6	8	22.11	21.69	22.21	24.71	23.65	23.67	14.1	h	13.7	h	14.2	h	16.7	h	31.7	h	31.7	h	<b>10.0</b>	<b>50.0</b>		
1884	RCS Piping - Line 6	8	18.96	18.95	18.95	19.94	20.05	20.05	11.0	h	11.0	h	11.0	h	11.9	h	28.1	h	28.1	h	<b>10.0</b>	<b>50.0</b>		
1891	RCS Piping - Line 2	8	31.35	32.33	30.28	19.59	32.06	32.04	23.4	h	24.3	h	22.3	h	11.6	h	40.1	h	40.0	h	<b>10.0</b>	<b>50.0</b>		
1892	RCS Piping - Line 2	8	30.97	32.72	31.29	27.5	29.69	29.66	23.0	h	24.7	h	23.3	h	19.5	h	37.7	h	37.7	h	<b>10.0</b>	<b>50.0</b>		
1893	RCS Piping - Line 2	8	26.51	29.27	27.01	24.01	22.88	22.83	18.5	h	21.3	h	19.0	h	16.0	h	30.9	h	30.8	h	<b>10.0</b>	<b>50.0</b>		

**Note :**

- (1) The temperature (including uncertainty) reached by TWTA in nominal Cold Case B & C is  $-20.6^{\circ}\text{C}$ . The temperature value is obtained at the end of the 21 hours of Scientific mode (unit non operative) and it is above the switch-on temperature limit of the unit ( $-30^{\circ}\text{C}$ ).
- (2) The temperature (including uncertainty) reached by FOG (ICU) in Cold case A3 is  $-2.9^{\circ}\text{C}$  vs a minimum operative limit of  $0^{\circ}\text{C}$ . In this case it is possible raise the temperature above  $0^{\circ}\text{C}$  switching on at 100% the 4K CRU's heaters mounted on the same shear panel.

In Hot cases B1 and B2, the maximum temperatures reached by the HP vertical nodes 811-826 and 861-876 are higher respect to the previous analysis results. The increase of the temperature is mainly due to the increase of the Heat pipes heater thresholds in Hot cases ( $2^{\circ}\text{C}$  higher), in order to have only one set of heater settings, all along the satellite lifetime and avoid different settings between BOL and EOL conditions.

Since the heaters are enabled also in hot cases (HP heater consumption in case B1 = 12.5W and in case B2 = 25.7W), the temperatures of SCC nodes (unit and HP network) are presented without uncertainty.

#### 8.5.4.2 Change of attitude transient case results

Transient analysis cases were run to assess the thermal behaviour of the SVM when subjected to attitude change (sun from 0 deg to +10 deg on -X side). Main purpose was to verify the capability of the design to meet the stability requirements. In paragraphs 8.4 / 8.5 / 8.6 / 8.7 the temperature plots of the main units during the change of attitude transient cases P1 and Q2 are shown, with change of attitude occurring at Time =86400s. The complete temperature data are reported in AD25.

### 8.5.4.3 Heater Power Summary

The following table reports the heater power consumption for the transient nominal analysis cases.

Table 8.5.4.3-1 PLANCK - Heater power need

Line	NODE	Description	Installed power	A1 BOL Mode1	A2 BOL Mode2	A3 BOL Mode3	C BOL Surv	B1 EOL SCC1 on	B2 EOL8 SCC2 on
			[ W ]						
	<b>TOTAL</b>		<b>961.88</b>	<b>92.43</b>	<b>97.98</b>	<b>97.66</b>	<b>741.32</b>	<b>19.14</b>	<b>32.23</b>
24	8508	1FCV BODY	2.35	0.61	0.8	0.86	2.05	0	0
38	8608	1FCV BODY	2.35	0.82	1	1.07	2.07	0.35	0.33
25	8708	1FCV BODY	2.35	0	0	0	0.66	0	0
39	8808	1FCV BODY	2.35	0.23	0.58	0.57	0.66	0	0
26	1133	FCV BODY	2.35	0	0	0	0	0	0
40	1134	FCV BODY	2.35	0	0	0	0	0	0
27	1233	FCV BODY	2.35	0	0	0	0	0	0
41	1234	FCV BODY	2.35	0	0	0	0	0	0
28	1333	FCV BODY	2.35	0	0	0	0	0	0
42	1334	FCV BODY	2.35	0	0	0	0	0	0
29	1433	FCV BODY	2.35	0	0	0	0	0	0
43	1434	FCV BODY	2.35	0	0	0	0.38	0	0
30	1533	FCV BODY	2.35	0	0	0	0	0	0
44	1534	FCV BODY	2.35	0	0	0	0.33	0	0
31	1733	FCV BODY	2.35	0	0.01	0.01	0	0	0
45	1734	FCV BODY	2.35	0	0	0	0	0	0
1	5427	STR MY -X	4.7	0	0	0	0.49	0	0
2	5527	STR PY -X	4.7	0	0	0	0.49	0	0
3	13	DPU1	22.78	0	0	0	15.71	0	0
4	14	DPU2	22.78	0	0	0	3.02	0	0
36	103	REBA2	22.78	0	0	0	12.28	0	0
35	202	4K CAU	38.98	0	0	0	33.56	0	0
16	203	4K CRU EX 4K	12.8	0	0	0	0	0	0
6	220	4K CCU I/F	51.92	0	0	0	46.86	0	0
5	205	REU	62.04	0	0	0	40.58	0	0
15	522	PAU	8.1	0	0	0	0	0	0
37	703	BATTERY	14.9	0	0	0	0	0	0
14	910	Helium Tank	3.08	0	0.57	0.35	0	0	0
21	920	Prop. Tank	6.17	0	0	0	2.8	0	0
22	925	Prop. Tank -Z	6.17	0	0	0	2.8	0	0
23	930	Prop. Tank -Y+Z	6.17	0	0	0	2.8	0	0
7	HP7	SCC / SCE Heat	78	78	78	78	78	12.54	25.7
8	HP8	SCC / SCE Heat	78	1.71	3.97	3.75	78	0	0
9	HP9	SCC / SCE Heat	91	0	0	0	91	0	0
10	HP10	SCC / SCE Heat	91	0	0	0	91	0	0
11	HP11	SCC / SCE Heat	91	0	0	0	91	0	0
12	HP12	SCC / SCE Heat	91	0	0	0	91	0	0
13	HP13	SCC / SCE Heat	91	0	0	0	36.5	0	0
32	LINE 1	RCS LINE 1	4.9	0.26	0.4	0.48	2.78	0	0
33	LINE 2	RCS LINE 2	3.96	1.42	1.65	1.71	2.33	0.85	0.85
34	LINE 3	RCS LINE 3	5.27	2.11	2.54	2.53	4.36	0.95	0.94
46	LINE 4	RCS LINE 4	4.03	2.69	3.35	3.12	2.97	1.55	1.54
47	LINE 5	RCS LINE 5	3.78	3.32	3.73	3.73	2.44	2	1.97
48	LINE 6	RCS LINE 6	3.27	1.26	1.38	1.48	2.4	0.9	0.9

#### 8.5.4.4 Redundancy Analysis

A series of additional analysis has been performed to verify the temperatures behaviour when the redundancy units are activated. In particular the following hot case analysis have been considered (SAA=0 deg):

##### Transient nominal analysis

- TT &C activation of line 2 (with – SCC2 on)
- DPU2 and REBA2 On (with – SCC2 on)
- In addition a case with both Star Tracker activated has been also performed. (with – SCC2 on)

In redundant case with both STR on, the **4K CEU** reach a temperature of 40.2°C (uncertainty included) vs 40.0° of maximum operative limit.

Table 8.5.4.4-1 PLANCK - Redundancy analysis temperature results

NODE	LABEL	UFP	STR1-2 on	TTC2 on	REBA2-DPU2 on	STR1-2 on	TTC2 on	REBA2-DPU2 on	TEMPERATURE LIMIT			
									MIN	MAX	MIN	MAX
									OPER.	OPER.	N.OPER	N.OPER
			Max	Max	Max	Tmax+UFP	Tmax+UFP	Tmax+UFP	[°C]	[°C]	[°C]	[°C]
			[°C]	[°C]	[°C]	[°C]	[°C]	[°C]	[°C]	[°C]	[°C]	[°C]
5427	STR_MY -X FOOT	9.2	24.64	21.27	22.34	33.8	30.5	31.5	-20.0	40.0	-30.0	50.0
5428	STR_MY +Y FOOT	9.2	24.80	21.3	22.35	34.0	30.5	31.6	-20.0	40.0	-30.0	50.0
5429	STR_MY +X FOOT	9.2	24.51	21.1	22.17	33.7	30.3	31.4	-20.0	40.0	-30.0	50.0
5430	STR_MY -Y FOOT	9.2	24.67	21.17	22.22	33.9	30.4	31.4	-20.0	40.0	-30.0	50.0
5414	<14> CCD HOUSING	9.2	20.21	21.67	22.71	29.4	30.9	31.9	-20.0	40.0	-30.0	50.0
5527	STR_PY -X FOOT	7.3	26.39	-9.24	-11.03	33.7	-1.9	-3.7	-20.0	40.0	-30.0	50.0
5528	STR_PY +Y FOOT	7.3	26.46	-9.3	-11.14	33.8	-2.0	-3.8	-20.0	40.0	-30.0	50.0
5529	STR_PY +X FOOT	7.3	26.23	-9.34	-11.14	33.5	-2.0	-3.8	-20.0	40.0	-30.0	50.0
5530	STR_PY -Y FOOT	7.2	26.33	-9.31	-11.14	33.5	-2.1	-3.9	-20.0	40.0	-30.0	50.0
5514	<14> CCD HOUSING	7.3	20.23	-9.39	-11.22	27.5	-2.1	-3.9	-20.0	40.0	-30.0	50.0
13	DPU1	8.1	14.17	12.21	-1.34	22.3	20.3	6.8	-10.0	40.0	-20.0	50.0
14	DPU2	7.6	2.31	0.85	13.92	9.9	8.5	21.5	-10.0	40.0	-20.0	50.0
101	DCCU	8	20.02	19.4	18.67	28.0	27.4	26.7	-10.0	40.0	-20.0	50.0
102	REBA1	8.5	34.60	33.83	7.03	43.1	42.3	15.5	-20.0	50.0	-30.0	50.0
103	REBA2	7.8	3.06	2.24	27.33	10.9	10.0	35.1	-20.0	50.0	-30.0	50.0
104	FOG (GEU)	8.3	38.32	37.18	35.28	46.6	45.5	43.6	0.0	45.0	-40.0	75.0
105	FOG (ICU)	8	19.61	18.56	20.83	27.6	26.6	28.8	0.0	45.0	-40.0	75.0
202	4K CAU	8.1	0.86	0.66	0.55	9.0	8.8	8.7	-10.0	40.0	-20.0	50.0

NODE	LABEL	UFP	STR1-2 on	TTC2 on	REBA2-DPU2 on	STR1-2 on	TTC2 on	REBA2-DPU2 on	TEMPERATURE LIMIT				
									MIN	MAX	MIN	MAX	
									OPER.	OPER.	N.OPER	N.OPER	
									[°C]	[°C]	[°C]	[°C]	
			Max	Max	Max	Tmax+UFP	Tmax+UFP	Tmax+UFP					
			[°C]	[°C]	[°C]	[°C]	[°C]	[°C]					
203	4K CRU EX 4K PRE-REG	8.7	38.22	36.86	33.88	46.9	45.6	42.6		-10.0	40.0	-20.0	50.0
204	CEU	9.3	30.94	30.7	30.52	40.2	40.0	39.8		-10.0	40.0	-20.0	50.0
205	REU	9.2	26.49	26.24	26.07	35.7	35.4	35.3		-10.0	40.0	-20.0	50.0
211	4K CCU Compress.1	11	47.56	47.39	47.29	58.6	58.4	58.3					
212	4K CCU Compress.2	10.5	42.29	42.11	42.01	52.8	52.6	52.5					
219	4K CCU I/F Bracket -X	9.1	12.85	12.68	12.57	22.0	21.8	21.7		-10.0	40.0	-20.0	40.0
220	4K CCU I/F Bracket +X	8.6	6.87	6.7	6.6	15.5	15.3	15.2		-10.0	40.0	-20.0	40.0
221	4K CCU I/F Strap -Z	9.9	26.39	26.22	26.13	36.3	36.1	36.0		-10.0	40.0	-20.0	40.0
222	4K CCU I/F Strap +Z	9.8	24.98	24.81	24.71	34.8	34.6	34.5		-10.0	40.0	-20.0	40.0
401	SCE1	9.3	-12.23	-12.25	-12.24	-12.2	-12.3	-12.2		-10.0	40.0	-20.0	50.0
402	SCE2	9.3	-7.76	-7.77	-7.77	-7.8	-7.8	-7.8		-10.0	40.0	-20.0	50.0
519	BEU	9.2	25.35	25	25	34.6	34.2	34.2		-20.0	40.0	-30.0	50.0
520	BEU	9.3	20.56	20.22	20.21	29.9	29.5	29.5		-20.0	40.0	-30.0	50.0
521	BEU	9.2	27.06	26.71	26.69	36.3	35.9	35.9		-20.0	40.0	-30.0	50.0
522	PAU	8.6	23.69	23.34	23.35	32.3	31.9	32.0		-10.0	30.0	-20.0	50.0
525	DAE POWER BOX	8.1	32.68	32.13	32.2	40.8	40.2	40.3		-20.0	50.0	-30.0	50.0
551	CRS3	8.5	30.14	28.66	29.94	38.6	37.2	38.4		0.0	50.0	-25.0	55.0
601	XPND_1	8.3	21.60	10.89	21.43	29.9	19.2	29.7		-10.0	45.0	-20.0	60.0
602	XPND_2	7.9	11.99	21.72	11.81	19.9	29.6	19.7		-10.0	45.0	-20.0	60.0
603	TWTA_1	8.8	31.95	5.59	31.78	40.8	14.4	40.6		-20.0	60.0	-30.0	70.0
604	TWTA_2	7.7	4.86	29.03	4.67	12.6	36.7	12.4		-20.0	60.0	-30.0	70.0

NODE	LABEL	UFP	STR1-2 on	TTC2 on	REBA2-DPU2 on	STR1-2 on	TTC2 on	REBA2-DPU2 on	TEMPERATURE LIMIT			
									MIN	MAX	MIN	MAX
									OPER.	OPER.	N.OPER	N.OPER
									[°C]	[°C]	[°C]	[°C]
605	RFDN	7.9	17.44	16.25	17.24	25.3	24.2	25.1	-25.0	55.0	-35.0	65.0
606	EPC1	8.3	22.94	8.71	22.76	31.2	17.0	31.1	-20.0	60.0	-30.0	70.0
607	EPC2	7.7	9.17	22.14	8.98	16.9	29.8	16.7	-20.0	60.0	-30.0	70.0
701	CDMU	8.1	21.09	20.59	21.02	29.2	28.7	29.1	-10.0	45.0	-20.0	55.0
702	ACC	8	14.53	14.01	14.54	22.5	22.0	22.5	-10.0	45.0	-20.0	55.0
703	BATT	8	18.18	18	18.01	26.2	26.0	26.0	0.0	35.0	N/A	N/A
704	PCDU	8.7	33.65	33.2	33.53	42.4	41.9	42.2	-10.0	45.0	-20.0	55.0
705	CRS1	8.6	35.88	35.25	35.7	44.5	43.9	44.3	0.0	50.0	-25.0	55.0
706	CRS2	8.7	39.03	38.95	38.86	47.7	47.7	47.6	0.0	50.0	-25.0	55.0
900	Helium Tank +Z	7.8	16.38	14.83	13.89	24.2	22.6	21.7	-10.0	40.0	-20.0	50.0
905	Helium Tank +Y	8.3	16.49	16.2	16.06	24.8	24.5	24.4	-10.0	40.0	-20.0	50.0
910	Helium Tank -Z	7.9	-5.67	-5.76	-5.75	2.2	2.1	2.2	-10.0	40.0	-20.0	50.0
915	Helium Tank -Y	8	18.41	17.17	18.19	26.4	25.2	26.2	-10.0	40.0	-20.0	50.0
920	Prop. Tank +Y+Z Lower	8	25.02	24.51	24.37	33.0	32.5	32.4	10.0	50.0	10.0	50.0
925	Prop. Tank -Z Lower	8.1	25.77	25.37	25.35	33.9	33.5	33.5	10.0	50.0	10.0	50.0
930	Prop. Tank -Y+Z Lower	8	24.26	23.79	23.89	32.3	31.8	31.9	10.0	50.0	10.0	50.0
311	SCC1 - Outer shell1	9.9	-11.85	-11.86	-11.85	-11.9	-11.9	-11.9				
312	SCC1 - Outer shell2	9.9	-11.85	-11.86	-11.85	-11.9	-11.9	-11.9				
313	SCC1 - Outer shell3	9.9	-11.85	-11.86	-11.85	-11.9	-11.9	-11.9				
314	SCC1 - Outer shell4	9.9	-11.85	-11.86	-11.85	-11.9	-11.9	-11.9				
315	SCC1 - Outer shell5	9.9	-11.85	-11.86	-11.85	-11.9	-11.9	-11.9				

NODE	LABEL	UFP	STR1-2 on	TTC2 on	REBA2-DPU2 on	STR1-2 on	TTC2 on	REBA2-DPU2 on	TEMPERATURE LIMIT			
									MIN	MAX	MIN	MAX
									OPER.	OPER.	N.OPER	N.OPER
									[°C]	[°C]	[°C]	[°C]
316	SCC1 - Outer shell6	9.9	-11.85	-11.86	-11.85	-11.9	-11.9	-11.9				
811	HP11 Ver. SCC1	9.7	-11.82	-11.83	-11.83	-11.8	-11.8	-11.8	<b>-13.0</b>	<b>7.0</b>	<b>-20.0</b>	<b>50.0</b>
812	HP12 Ver. SCC1	9.7	-11.84	-11.85	-11.84	-11.8	-11.9	-11.8	<b>-13.0</b>	<b>7.0</b>	<b>-20.0</b>	<b>50.0</b>
813	HP13 Ver. SCC1	9.7	-11.84	-11.85	-11.84	-11.8	-11.9	-11.8	<b>-13.0</b>	<b>7.0</b>	<b>-20.0</b>	<b>50.0</b>
814	HP14 Ver. SCC1	9.7	-11.84	-11.85	-11.84	-11.8	-11.9	-11.8	<b>-13.0</b>	<b>7.0</b>	<b>-20.0</b>	<b>50.0</b>
815	HP15 Ver. SCC1	9.7	-11.84	-11.85	-11.84	-11.8	-11.9	-11.8	<b>-13.0</b>	<b>7.0</b>	<b>-20.0</b>	<b>50.0</b>
816	HP16 Ver. SCC1	9.7	-11.84	-11.85	-11.84	-11.8	-11.9	-11.8	<b>-13.0</b>	<b>7.0</b>	<b>-20.0</b>	<b>50.0</b>
817	HP17 Ver. SCC1	9.7	-11.84	-11.85	-11.84	-11.8	-11.9	-11.8	<b>-13.0</b>	<b>7.0</b>	<b>-20.0</b>	<b>50.0</b>
818	HP18 Ver. SCC1	9.7	-11.84	-11.85	-11.84	-11.8	-11.9	-11.8	<b>-13.0</b>	<b>7.0</b>	<b>-20.0</b>	<b>50.0</b>
819	HP19 Ver. SCC1	9.7	-11.84	-11.85	-11.84	-11.8	-11.9	-11.8	<b>-13.0</b>	<b>7.0</b>	<b>-20.0</b>	<b>50.0</b>
820	HP20 Ver. SCC1	9.7	-11.84	-11.85	-11.84	-11.8	-11.9	-11.8	<b>-13.0</b>	<b>7.0</b>	<b>-20.0</b>	<b>50.0</b>
821	HP21 Ver. SCC1	9.7	-11.84	-11.85	-11.84	-11.8	-11.9	-11.8	<b>-13.0</b>	<b>7.0</b>	<b>-20.0</b>	<b>50.0</b>
822	HP22 Ver. SCC1	9.7	-11.84	-11.85	-11.84	-11.8	-11.9	-11.8	<b>-13.0</b>	<b>7.0</b>	<b>-20.0</b>	<b>50.0</b>
823	HP23 Ver. SCC1	9.7	-11.84	-11.85	-11.84	-11.8	-11.9	-11.8	<b>-13.0</b>	<b>7.0</b>	<b>-20.0</b>	<b>50.0</b>
824	HP24 Ver. SCC1	9.7	-11.84	-11.85	-11.84	-11.8	-11.9	-11.8	<b>-13.0</b>	<b>7.0</b>	<b>-20.0</b>	<b>50.0</b>
825	HP25 Ver. SCC1	9.7	-11.84	-11.85	-11.84	-11.8	-11.9	-11.8	<b>-13.0</b>	<b>7.0</b>	<b>-20.0</b>	<b>50.0</b>
826	HP26 Ver. SCC1	9.7	-11.82	-11.83	-11.83	-11.8	-11.8	-11.8	<b>-13.0</b>	<b>7.0</b>	<b>-20.0</b>	<b>50.0</b>
801	HP1 Hor. SCC1	9.3	-11.78	-11.8	-11.79	-11.8	-11.8	-11.8				
802	HP2 Hor. SCC1	9.3	-11.73	-11.73	-11.73	-11.7	-11.7	-11.7				
803	HP3 Hor. SCC1	9.3	-12.36	-12.37	-12.37	-12.4	-12.4	-12.4				
804	HP4 Hor. SCC1	9.3	-12.44	-12.45	-12.45	-12.4	-12.5	-12.5				



NODE	LABEL	UFP	TEMPERATURE LIMIT										
			STR1-2 on	TTC2 on	REBA2-DPU2 on	STR1-2 on	TTC2 on	REBA2-DPU2 on	MIN	MAX	MIN	MAX	
			Max	Max	Max	Tmax+UFP	Tmax+UFP	Tmax+UFP	OPER.	OPER.	N.OPER	N.OPER	
			[°C]	[°C]	[°C]	[°C]	[°C]	[°C]	[°C]	[°C]	[°C]	[°C]	
805	HP5 Hor. SCC1	9.3	-11.94	-11.94	-11.94	-11.9	-11.9	-11.9					
806	HP6 Hor. SCC1	9.3	-11.00	-11.02	-11.01	-11.0	-11.0	-11.0					
807	HP7 Hor. SCC1	9.3	-10.91	-10.92	-10.92	-10.9	-10.9	-10.9					
808	HP7 Hor. SCC1	9.3	-10.52	-10.52	-10.52	-10.5	-10.5	-10.5					
511	SCC2 - Outer shell1	9.1	18.57	18.57	18.57	18.6	18.6	18.6					
512	SCC2 - Outer shell2	9.1	18.58	18.58	18.58	18.6	18.6	18.6					
513	SCC2 - Outer shell3	9.1	18.59	18.58	18.59	18.6	18.6	18.6					
514	SCC2 - Outer shell4	9.1	18.59	18.58	18.58	18.6	18.6	18.6					
515	SCC2 - Outer shell5	9.1	18.61	18.61	18.62	18.6	18.6	18.6					
516	SCC2 - Outer shell6	9.1	18.63	18.62	18.62	18.6	18.6	18.6					
861	HP61 Ver. SCC2	9.7	-2.79	-2.8	-2.8	-2.8	-2.8	-2.8	<b>-13.0</b>	<b>7.0</b>	<b>-20.0</b>	<b>50.0</b>	
862	HP62 Ver. SCC2	9.7	-1.23	-1.24	-1.24	-1.2	-1.2	-1.2	<b>-13.0</b>	<b>7.0</b>	<b>-20.0</b>	<b>50.0</b>	
863	HP63 Ver. SCC2	9.7	-1.23	-1.24	-1.24	-1.2	-1.2	-1.2	<b>-13.0</b>	<b>7.0</b>	<b>-20.0</b>	<b>50.0</b>	
864	HP64 Ver. SCC2	9.7	-1.23	-1.24	-1.24	-1.2	-1.2	-1.2	<b>-13.0</b>	<b>7.0</b>	<b>-20.0</b>	<b>50.0</b>	
865	HP65 Ver. SCC2	9.7	-1.23	-1.24	-1.24	-1.2	-1.2	-1.2	<b>-13.0</b>	<b>7.0</b>	<b>-20.0</b>	<b>50.0</b>	
866	HP66 Ver. SCC2	9.7	-1.23	-1.24	-1.24	-1.2	-1.2	-1.2	<b>-13.0</b>	<b>7.0</b>	<b>-20.0</b>	<b>50.0</b>	
867	HP67 Ver. SCC2	9.7	-1.23	-1.24	-1.24	-1.2	-1.2	-1.2	<b>-13.0</b>	<b>7.0</b>	<b>-20.0</b>	<b>50.0</b>	
868	HP68 Ver. SCC2	9.7	-1.23	-1.24	-1.24	-1.2	-1.2	-1.2	<b>-13.0</b>	<b>7.0</b>	<b>-20.0</b>	<b>50.0</b>	
869	HP69 Ver. SCC2	9.7	-1.23	-1.24	-1.24	-1.2	-1.2	-1.2	<b>-13.0</b>	<b>7.0</b>	<b>-20.0</b>	<b>50.0</b>	
870	HP70 Ver. SCC2	9.7	-1.23	-1.24	-1.24	-1.2	-1.2	-1.2	<b>-13.0</b>	<b>7.0</b>	<b>-20.0</b>	<b>50.0</b>	
871	HP71 Ver. SCC2	9.7	-1.23	-1.24	-1.24	-1.2	-1.2	-1.2	<b>-13.0</b>	<b>7.0</b>	<b>-20.0</b>	<b>50.0</b>	

NODE	LABEL	UFP	TEMPERATURE LIMIT									
			STR1-2 on	TTC2 on	REBA2-DPU2 on	STR1-2 on	TTC2 on	REBA2-DPU2 on	MIN	MAX	MIN	MAX
			Max	Max	Max	Tmax+UFP	Tmax+UFP	Tmax+UFP	OPER.	OPER.	N.OPER	N.OPER
			[°C]	[°C]	[°C]	[°C]	[°C]	[°C]	[°C]	[°C]	[°C]	[°C]
872	HP72 Ver. SCC2	9.7	-1.23	-1.24	-1.24	-1.2	-1.2	-1.2	-13.0	7.0	-20.0	50.0
873	HP73 Ver. SCC2	9.7	-1.23	-1.24	-1.24	-1.2	-1.2	-1.2	-13.0	7.0	-20.0	50.0
874	HP74 Ver. SCC2	9.7	-1.23	-1.24	-1.24	-1.2	-1.2	-1.2	-13.0	7.0	-20.0	50.0
875	HP75 Ver. SCC2	9.7	-1.23	-1.24	-1.24	-1.2	-1.2	-1.2	-13.0	7.0	-20.0	50.0
876	HP76 Ver. SCC2	9.7	-2.79	-2.8	-2.8	-2.8	-2.8	-2.8	-13.0	7.0	-20.0	50.0
851	HP51 Hor. SCC2	9.1	-7.70	-7.72	-7.72	-7.7	-7.7	-7.7				
852	HP52 Hor. SCC2	9.1	-7.90	-7.91	-7.91	-7.9	-7.9	-7.9				
853	HP53 Hor. SCC2	9.1	-8.23	-8.25	-8.24	-8.2	-8.3	-8.2				
854	HP54 Hor. SCC2	9.1	-8.33	-8.34	-8.34	-8.3	-8.3	-8.3				
855	HP55 Hor. SCC2	9.1	-8.24	-8.25	-8.25	-8.2	-8.3	-8.3				
856	HP56 Hor. SCC2	9.1	-7.80	-7.81	-7.81	-7.8	-7.8	-7.8				
857	HP57 Hor. SCC2	9.1	-7.75	-7.77	-7.76	-7.8	-7.8	-7.8				
858	HP57 Hor. SCC2	9.1	-7.65	-7.66	-7.66	-7.7	-7.7	-7.7				
3931	SAS1 HOUSING	9.2	11.56	11.34	11.2	20.8	20.5	20.4	-70.0	80.0	-80.0	90.0
3951	SAS2 HOUSING	7.5	61.06	60.35	60.32	68.6	67.9	67.8	-70.0	80.0	-80.0	90.0
3921	LGA+Y HORN	8.3	-43.13	-43.25	-43.32	-34.8	-35.0	-35.0	-150.0	120.0	-150.0	120.0
3961	LGA-Y HORN	8.2	-55.01	-49.62	-55.1	-46.8	-41.4	-46.9	-150.0	120.0	-150.0	120.0
3991	LGA-X HORN	7.2	70.05	69.93	69.92	77.3	77.1	77.1	-150.0	120.0	-150.0	120.0
3986	MGA-X SEPTUM	8.5	51.59	51.31	51.29	60.1	59.8	59.8	-150.0	150.0	-150.0	150.0
3966	SREM	8.2	23.25	22.65	21.81	31.5	30.9	30.0	-10.0	50.0	-45.0	90.0
3970	AAD HOUSING	8.8	51.12	50.35	50.31	59.9	59.2	59.1	-70.0	70.0	-80.0	80.0

NODE	LABEL	UFP	STR1-2 on	TTC2 on	REBA2-DPU2 on	STR1-2 on	TTC2 on	REBA2-DPU2 on	TEMPERATURE LIMIT			
									MIN	MAX	MIN	MAX
									OPER.	OPER.	N.OPER	N.OPER
									[°C]	[°C]	[°C]	[°C]
8508	1FCV BODY	7.9	15.63	15.55	15.63	23.5	23.5	23.5	10.0	60.0	10.0	70.0
8608	1FCV BODY	7.8	17.05	17.08	17.04	24.9	24.9	24.8	10.0	60.0	10.0	70.0
8708	1FCV BODY	8	20.41	19.52	20.22	28.4	27.5	28.2	10.0	60.0	10.0	70.0
8808	1FCV BODY	8	20.23	19.35	20.04	28.2	27.4	28.0	10.0	60.0	10.0	70.0
1133	FCV BODY MAIN	7.8	36.51	35.55	36.67	44.3	43.4	44.5	10.0	60.0	10.0	70.0
1134	FCV BODY REDUNDANT	7.9	35.63	34.68	35.8	43.5	42.6	43.7	10.0	60.0	10.0	70.0
1233	FCV BODY MAIN	7.6	32.66	32.63	32.63	40.3	40.2	40.2	10.0	60.0	10.0	70.0
1234	FCV BODY REDUNDANT	7.7	32.58	32.55	32.55	40.3	40.3	40.3	10.0	60.0	10.0	70.0
1333	FCV BODY MAIN	7.9	33.85	35.57	33.71	41.8	43.5	41.6	10.0	60.0	10.0	70.0
1334	FCV BODY REDUNDANT	8	33.68	35.41	33.54	41.7	43.4	41.5	10.0	60.0	10.0	70.0
1433	FCV BODY MAIN	8.1	35.84	34.08	31.22	43.9	42.2	39.3	10.0	60.0	10.0	70.0
1434	FCV BODY REDUNDANT	7.9	35.72	33.97	31.13	43.6	41.9	39.0	10.0	60.0	10.0	70.0
1533	FCV BODY MAIN	9.2	22.94	22.78	22.7	32.1	32.0	31.9	10.0	60.0	10.0	70.0
1534	FCV BODY REDUNDANT	9.3	22.72	22.56	22.48	32.0	31.9	31.8	10.0	60.0	10.0	70.0
1733	FCV BODY MAIN	8.8	21.16	20.96	21.02	30.0	29.8	29.8	10.0	60.0	10.0	70.0
1734	FCV BODY REDUNDANT	8.8	21.32	21.13	21.19	30.1	29.9	30.0	10.0	60.0	10.0	70.0
1801	RCS Piping - Line 4	8	34.40	34.45	34.44	42.4	42.5	42.4	10.0	50.0		
1802	RCS Piping - Line 5	8	37.46	39.45	39.74	45.5	47.5	47.7	10.0	50.0		
1803	RCS Piping - Line 5	8	30.91	31.16	31.2	38.9	39.2	39.2	10.0	50.0		
1804	RCS Piping - Line 4	8	36.46	36.51	36.49	44.5	44.5	44.5	10.0	50.0		
1805	RCS Piping - Line 3	8	28.82	29.04	29.04	36.8	37.0	37.0	10.0	50.0		

NODE	LABEL	UFP					TEMPERATURE LIMIT					
			STR1-2 on	TTC2 on	REBA2-DPU2 on	STR1-2 on	TTC2 on	REBA2-DPU2 on	MIN	MAX	MIN	MAX
			Max	Max	Max	Tmax+UFP	Tmax+UFP	Tmax+UFP	OPER.	OPER.	N.OPER	N.OPER
			[°C]	[°C]	[°C]	[°C]	[°C]	[°C]	[°C]	[°C]	[°C]	[°C]
1806	RCS Piping - Line 2	8	35.08	36.38	35.62	43.1	44.4	43.6	10.0	50.0		
1809	RCS Piping - Line 2	8	31.98	33.08	33.08	40.0	41.1	41.1	10.0	50.0		
1810	RCS Piping - Line 6	8	27.31	28.29	28.17	35.3	36.3	36.2	10.0	50.0		
1811	RCS Piping - Line 6	8	29.67	30.64	30.45	37.7	38.6	38.5	10.0	50.0		
1812	RCS Piping - Line 6	8	27.68	28.86	28.73	35.7	36.9	36.7	10.0	50.0		
1813	RCS Piping - Line 6	8	29.36	30.81	30.61	37.4	38.8	38.6	10.0	50.0		
1814	RCS Piping - Line 4	8	36.12	36.28	36.28	44.1	44.3	44.3	10.0	50.0		
1815	RCS Piping - Line 4	8	35.97	36.05	36.05	44.0	44.1	44.1	10.0	50.0		
1816	RCS Piping - Line 4	8	36.17	36.23	36.24	44.2	44.2	44.2	10.0	50.0		
1817	RCS Piping - Line 3	8	30.11	30.79	30.81	38.1	38.8	38.8	10.0	50.0		
1818	RCS Piping - Line 5	8	22.15	21.81	22.21	30.2	29.8	30.2	10.0	50.0		
1819	RCS Piping - Line 6	8	29.39	31.21	30.83	37.4	39.2	38.8	10.0	50.0		
1820	RCS Piping - Line 2	8	37.04	38.11	37.13	45.0	46.1	45.1	10.0	50.0		
1821	RCS Piping - Line 3	8	22.29	23.09	23.18	30.3	31.1	31.2	10.0	50.0		
1822	RCS Piping - Line 3	8	27.27	27.74	27.81	35.3	35.7	35.8	10.0	50.0		
1823	RCS Piping - Line 2	8	32.03	36.02	35.69	40.0	44.0	43.7	10.0	50.0		
1831	RCS Piping - Line 4	8	18.14	18.57	18.57	26.1	26.6	26.6	10.0	50.0		
1832	RCS Piping - Line 4	8	25.06	25.15	25.15	33.1	33.2	33.2	10.0	50.0		
1841	RCS Piping - Line 5	8	24.80	24.78	24.83	32.8	32.8	32.8	10.0	50.0		
1842	RCS Piping - Line 5	8	24.45	23.99	24.48	32.4	32.0	32.5	10.0	50.0		
1843	RCS Piping - Line 5	8	22.46	22.11	22.52	30.5	30.1	30.5	10.0	50.0		



Alcatel Alenia Space Italia S.p.A.

DOC. No : H-P-RP-AI-0040  
 ISSUE : 05  
 DATE : 24/FEB/06  
 PAGE : 181 of 341  
 CLASS. : DC  
 ANNEXES : ..... Pages....

NODE	LABEL	UFP	TEMPERATURE LIMIT									
			STR1-2 on	TTC2 on	REBA2-DPU2 on	STR1-2 on	TTC2 on	REBA2-DPU2 on	MIN	MAX	MIN	MAX
			Max	Max	Max	Tmax+UFP	Tmax+UFP	Tmax+UFP	OPER.	OPER.	N.OPER	N.OPER
			[°C]	[°C]	[°C]	[°C]	[°C]	[°C]	[°C]	[°C]	[°C]	[°C]
1850	PT - Line 1	8	20.67	21.36	20.92	28.7	29.4	28.9	10.0	50.0		
1851	LV1 - Line 1	8	21.88	22.33	21.96	29.9	30.3	30.0	10.0	50.0		
1852	LV2 - Line 1	8	21.91	22.35	21.99	29.9	30.4	30.0	10.0	50.0		
1853	LF - Line 1	8	21.94	22.38	22.03	29.9	30.4	30.0	10.0	50.0		
1854	RCS Piping - Line 3	8	27.89	28.55	28.24	35.9	36.6	36.2	10.0	50.0		
1855	RCS Piping - Line 3	8	29.44	30.12	29.85	37.4	38.1	37.9	10.0	50.0		
1856	RCS Piping - Line 3	8	27.55	28.31	28.02	35.5	36.3	36.0	10.0	50.0		
1857	RCS Piping - Line 3	8	27.68	28.79	28.76	35.7	36.8	36.8	10.0	50.0		
1859	RCS Piping - Line 3	8	28.64	29.31	29.08	36.6	37.3	37.1	10.0	50.0		
1860	RCS Piping - Line 4	8	40.87	40.93	40.95	48.9	48.9	49.0	10.0	50.0		
1861	RCS Piping - Line 4	8	39.07	39.12	39.13	47.1	47.1	47.1	10.0	50.0		
1862	RCS Piping - Line 3	8	32.52	32.86	32.88	40.5	40.9	40.9	10.0	50.0		
1863	RCS Piping - Line 5	8	37.49	39.25	39.54	45.5	47.3	47.5	10.0	50.0		
1864	RCS Piping - Line 4	8	31.55	31.8	31.61	39.6	39.8	39.6	10.0	50.0		
1865	RCS Piping - Line 6	8	29.12	29.97	29.62	37.1	38.0	37.6	10.0	50.0		
1866	RCS Piping - Line 6	8	27.86	28.86	28.7	35.9	36.9	36.7	10.0	50.0		
1867	RCS Piping - Line 5	8	29.98	30.02	30.02	38.0	38.0	38.0	10.0	50.0		
1868	RCS Piping - Line 2	8	32.96	33.83	33.05	41.0	41.8	41.1	10.0	50.0		
1869	RCS Piping - Line 3	8	29.48	29.72	29.73	37.5	37.7	37.7	10.0	50.0		
1870	RCS Piping - Line 5	8	27.67	28.66	28.17	35.7	36.7	36.2	10.0	50.0		
1871	RCS Piping - Line 5	8	29.46	30.48	30.14	37.5	38.5	38.1	10.0	50.0		

NODE	LABEL	UFP	TEMPERATURE LIMIT									
			STR1-2 on	TTC2 on	REBA2-DPU2 on	STR1-2 on	TTC2 on	REBA2-DPU2 on	MIN	MAX	MIN	MAX
			Max	Max	Max	Tmax+UFP	Tmax+UFP	Tmax+UFP	OPER.	OPER.	N.OPER	N.OPER
			[°C]	[°C]	[°C]	[°C]	[°C]	[°C]	[°C]	[°C]	[°C]	[°C]
1872	RCS Piping - Line 5	8	27.46	29.81	28.8	35.5	37.8	36.8	10.0	50.0		
1873	RCS Piping - Line 5	8	29.18	29.46	29.98	37.2	37.5	38.0	10.0	50.0		
1874	RCS Piping - Line 5	8	31.26	30.81	32.13	39.3	38.8	40.1	10.0	50.0		
1875	RCS Piping - Line 5	8	28.35	31.56	29.74	36.3	39.6	37.7	10.0	50.0		
1876	RCS Piping - Line 5	8	28.69	31.71	30.06	36.7	39.7	38.1	10.0	50.0		
1877	RCS Piping - Line 5	8	28.69	31.71	30.06	36.7	39.7	38.1	10.0	50.0		
1878	RCS Piping - Line 5	8	27.91	30.86	29.15	35.9	38.9	37.2	10.0	50.0		
1879	RCS Piping - Line 5	8	27.91	30.86	29.15	35.9	38.9	37.2	10.0	50.0		
1881	RCS Piping - Line 6	8	26.00	27.09	27.13	34.0	35.1	35.1	10.0	50.0		
1882	RCS Piping - Line 6	8	21.95	23.17	24.03	29.9	31.2	32.0	10.0	50.0		
1883	RCS Piping - Line 6	8	22.33	23.67	24.74	30.3	31.7	32.7	10.0	50.0		
1884	RCS Piping - Line 6	8	19.08	20.05	20.07	27.1	28.1	28.1	10.0	50.0		
1891	RCS Piping - Line 2	8	31.97	32.04	29.88	40.0	40.0	37.9	10.0	50.0		
1892	RCS Piping - Line 2	8	30.18	29.66	29.18	38.2	37.7	37.2	10.0	50.0		
1893	RCS Piping - Line 2	8	25.11	22.84	21.27	33.1	30.8	29.3	10.0	50.0		
8001	Solar Array vs. space -X	8	118.07	118.06	118.06	126.1	126.1	126.1				
8002	Solar Array vs. space-X	7.5	118.35	118.35	118.35	125.9	125.9	125.9				
8003	Solar Array vs. space -X	8.4	117.71	117.72	117.71	126.1	126.1	126.1				
8004	Solar Array vs. space -X	8.1	117.84	117.84	117.83	125.9	125.9	125.9				
8051	Solar Array vs. space -X	8	117.82	117.81	117.8	125.8	125.8	125.8				
8052	Solar Array vs. space +X	7.6	118.09	118.08	118.08	125.7	125.7	125.7				

NODE	LABEL	UFP	STR1-2 on	TTC2 on	REBA2-DPU2 on	STR1-2 on	TTC2 on	REBA2-DPU2 on	TEMPERATURE LIMIT			
									MIN	MAX	MIN	MAX
									OPER.	OPER.	N.OPER	N.OPER
			Max	Max	Max	Tmax+UFP	Tmax+UFP	Tmax+UFP	[°C]	[°C]	[°C]	[°C]
8053	Solar Array vs. space +X	8.4	117.45	117.46	117.45	125.9	125.9	125.9				
8054	Solar Array vs. space +X	8.1	117.58	117.59	117.58	125.7	125.7	125.7				
8301	Central Solar Array -X	7.9	121.90	121.9	121.9	129.8	129.8	129.8				
8302	Central Solar Array -X	8	121.39	121.39	121.39	129.4	129.4	129.4				
8303	Central Solar Array -X	8.1	120.78	120.77	120.77	128.9	128.9	128.9				
8304	Central Solar Array -X	7.9	121.54	121.54	121.54	129.4	129.4	129.4				
8351	Central Solar Array +X	7.9	121.70	121.69	121.69	129.6	129.6	129.6				
8352	Central Solar Array +X	8	121.19	121.18	121.18	129.2	129.2	129.2				
8353	Central Solar Array +X	8.1	120.58	120.57	120.57	128.7	128.7	128.7				
8354	Central Solar Array +X	7.9	121.34	121.33	121.33	129.2	129.2	129.2				
8101	MLI Solar Array vs. sate	27.7	11.10	10.99	10.85	38.8	38.7	38.6				
8102	MLI Solar Array vs. sate	26.9	13.03	13.01	13	39.9	39.9	39.9				
8103	MLI Solar Array vs. sate	27.2	12.30	12.4	12.28	39.5	39.6	39.5				
8104	MLI Solar Array vs. sate	27.3	11.09	11.08	11.02	38.4	38.4	38.3				

#### 8.5.4.5 Sun trapping on Solar Array

The effect of the sun trapping into the gap among the solar array panels of PLANCK, has been analyzed using a dedicated reduced model and considering the gap as a cavity.

The lateral sides of the cavity (solar array edge) have been assumed covered by black kapton tape, and the bottom of the cavity is a black kapton foil (see figure).

In this condition, considering the sun perpendicular to the cavity ( $SAA=0^\circ$ ) and in winter solstice (solar constant of  $1405 \text{ W/m}^2$ ) and assuming adiabatic condition (i.e. no flux exchange to the other surfaces), the following temperature are obtained:

- Lateral sides:  $106^\circ\text{C}$
- Bottom side:  $181^\circ\text{C}$

The  $181^\circ\text{C}$  maximum temperature is reached only by the bottom kapton foil and it has to be considered as a hot spot. While on the solar array lateral side the temperature of  $106^\circ\text{C}$  will not be exceeded.

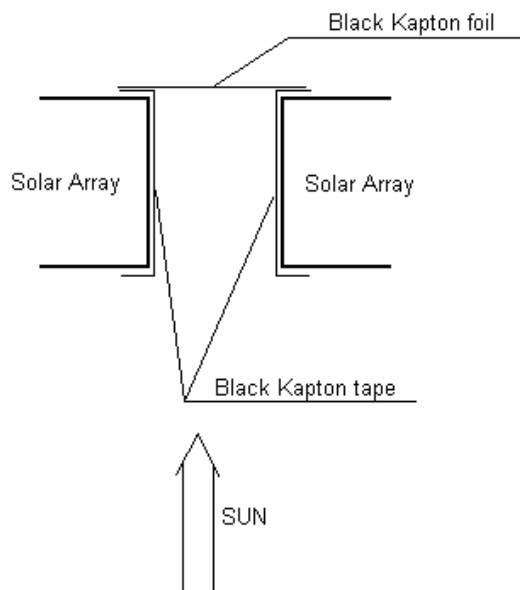

Figure 8.5.4.5-1 PLANCK – Sun trapping



## **9 CONCLUSIONS**

### **9.1 HERSCHEL**

The following thermal interface requirements are not compliant (NC) or partially compliant (PC) with respect to the applicable requirements and are treated by dedicated RFD:

- **ITP-100-H : NC**  
For details see applicable RFD (H-P-300000-ALS-RD-0009, Issue 2) issued by ALS and approved by ASP (see CCB#72, H-P-ASP-LT-5490) with no design modification.
- **ITP-120-H : PC and ITP-130-H : PC**  
For details see applicable RFD (H-P-300000-ALS-RD-0029, Issue 1) issued by ALS and approved by ASP (see CCB#69, H-P-ASP-MN-5329) with no design modification.  
After the TMM updating, the radiative area has been optimised with the objective to decrease the overall heater power consumption. As a consequence the satellite average temperature is increased and the requirement on the truss and shield attachment points can not completely met. This requirement could be satisfied decreasing again the average temperature of satellite, but with an important impact on power budget. Due to the limited average out of specification (25.7 °C vs 20°C and 22.8 °C vs 20°C) it is suggested to maintain the current design to avoid impact on the power budget.
- **ITI-020-H :**  
Preliminary verification and concept validation have been performed by AAS-I. Final verification, applicable to all the involved units, is still to be performed pending confirmation of stability requirements and I/F point control verification. AAS-I is waiting CR related these points (see H-P-ASP-MN-7404, dated 8/2/06). Based on this last step, all the necessary modifications (HW and SW) will be then imposed to the applicable suppliers.
- **ACP-060-H:**  
The stability requirement is Compliant. For what concern the stability around the set point the updated results have been submitted to OFFICINE GALILEO for evaluation of the STRs performances.

All the units are maintained within their temperature limits with the exclusion of the following:

**HOT CASES (Uncertainty included)**

- ❑ **CRS:** case B 51.3°C vs 50.0°C
- ❑ **TWT:** case B 71.1°C vs 60.0°C

A limited out of spec is present on the RCS nodes directly behind the Thruster on +Z, the SAS on +Z and the Thruster on +Y:

- ❑ **RCS #9 point on THRUSTER+Z:** case Bred 52.1°C vs 50.0°C
- ❑ **RCS #9 point on SAS+Z:** case Bred 51.5°C vs 50.0°C
- ❑ **RCS #47 point on THRUSTER+Y:** case E 51.2°C vs 50.0°C

**RECOVERY ACTIONS:**

**CRS:**

Due to the limited out of specification, AAS-I proposes to maintain the present design.

Moreover it has to be noted that the UFP value considers a 3°C fixed value of systematic modelling error that could be reduced.

Dedicated RFD (H-P-300000-ALS-RD-0040, Issue 1) issued by TCS has been approved by AAS-I at system level. No design modifications are envisaged.

**TWT:**

A preliminary assessment has been done taking into account the local analysis.

In the Thales TWT thermal analysis (40 63 362 issue 1 rev B) the baseplate thermal reference point can sustain 70°C with a maximum housing temperature of 82.7°C. The main temperature limitation is 175°C then a safety margin is present even with a baseplate thermal reference point at 71°C. No design modifications are envisaged.

Dedicated RFD (H-P-300000-ALS-RD-0040, Issue 1) issued by TCS has been approved by AAS-I at system level. No design modifications are envisaged.

**RCS:**

Due to the limited out of specification, AAS-I proposes to maintain the present design.

Moreover it has to be noted that the UFP value considers a 3°C fixed value of systematic modelling error that could be reduced.

No design modifications are envisaged.

**Remark:**

VMC unit the thermal design has been conceived considering this unit switched-on only up to the end of transfer orbit. In this condition the unit works correctly within the requested limits.

If the unit will be requested to be operative during the rest of the mission the hot case temperature reaches about 57°C (in EOL cases) vs 50°C of maximum operative limit.

**COLD CASES (Uncertainty included)**

A limited out of spec is present on some RCS nodes on the line 37 only in the **SURVIVAL CASE**. It has to be noted that the 8°C uncertainty has been always applied on the RCS nodes even if they are actively controlled by heaters.

## 9.2 PLANCK

The following thermal interface requirements are not compliant (NC) or partially compliant (PC) with respect to the applicable requirements and are treated by dedicated RFD:

- **ITP-150-P: NC**  
For details see RFD (H-P-300000-ALS-RD-0009, Issue 2) issued by ALS and approved by ASP (see CCB#72, H-P-ASP-LT-5490) with no design modification.
- **ITP-170-P: NC**  
The radiative flux between BEU/PAU radiators and PLM shield is 2.109 W if calculated without the uncertainty temperature. Considering the uncertainty temperature, as requested by ASP, the radiative flux is of 2.45W vs maximum radiative load of 2.3W.  
Based on this last analysis result a RFD (H-P-300000-ALS-RD-0010, Issue 3) has been issued by ALS and approved by ASP (see CCB#72, H-P-ASP-LT-5490) with no design modification.
- **ITP-180-P and ITP-200-P: NC**  
For details see RFD (H-P-300000-ALS-RD-0009, Issue 2) issued by ALS and approved by ASP (see CCB#72, H-P-ASP-LT-5490) with no design modification.
- **ITP-PROPELLANT TANK STABILITY: PC**  
The requirement relative to the gradient over the life of the satellite between each Propellant Tank is 1.809°C vs a maximum requested value of 1.5°C.  
No recovery actions are foreseen and w.r.t. previous value (2.08°C) a RFD (H-P-300000-ALS-RD-0030, Issue 1) has been issued and approved by ALS.  
This RFD has been also provided for info to ASP on 26/07/04 (ref. H-P-ALS-04-0370)
- **SCC Stability (Absorbing beds stability): NC**  
NC is due to the SCC High Amplitude Peak Power Dissipation and no recovery actions are envisaged.  
Request for Deviation (H-P-300000-ALS-RD-0013, Issue 4) has been issued and approved by ASP (see CCB#74, H-P-ASP-MN-5553).

All the units are maintained within their temperature limits with the exclusion of the following:

**HOT CASES (Uncertainty included)**

- **PAU:** case B1&B2 32.0°C vs 30.0°C  
RFD to cover an out of specification equal to 1°C (T unit ≈ 31°C) has been issued and approved by ASP (see CCB#72, H-P-ASP-LT-5490) with no design modification.
- **CRU\*\*:** case B1&B2 45.6°C vs 40.0°C  
(46.9°C when both STRs are on)
- **FOG (GEU)\*\*:** case B1&B2 45.5°C vs 45.0°C  
(46.6°C when both STRs are on)

**Remarks\*\*:** Results are obtained using new inputs provided by ESA (SCI-PT/33615, dated 02/02/05) that foreseen 4 channels switched-ON (26.8 watts dissipated).

In case only 3 channels (20.1 watts dissipated) have to be considered ON the temperatures are:

- **CRU:** 42.8°C (including 8.7°C of uncertainty). For a value equal to 41.8°C a RFD (H-P-300000-ALS-RD-0014, Issue 2) has been issued to ASP with letter HP-ALS-04-0426 dated 17/09/04.
- **FOG (GEU):** 41.1°C

As a recovery actions for both units, , ALS suggest to use FOG only with 3 channels ON

**COLD CASES (Uncertainty included)**

- **FOG (ICU)\*\*** case A3 -2.9°C vs 0.0°C

**Remarks\*\*:**

These results are obtained using new inputs provided by ESA (SCI-PT/33615, dated 02/02/05) that foreseen 3 channels switched-ON (16.5 watts dissipated).

The temperature (including uncertainty) reached by FOG (ICU) in Cold case A3 is -2.9 °C vs a minimum operative limit of 0.°C. In this case it is possible raise the temperature above 0°C switching on at 100% the 4K CRU's heaters (12.8 W) mounted on the same shear panel.

**10 HERSCHEL: TEMPERATURE PLOTS**

10.1 HERSCHEL RESULTS OF CASE B

**HERSCHEL HOT CASE B EOL**

**PANEL +Y+Z**

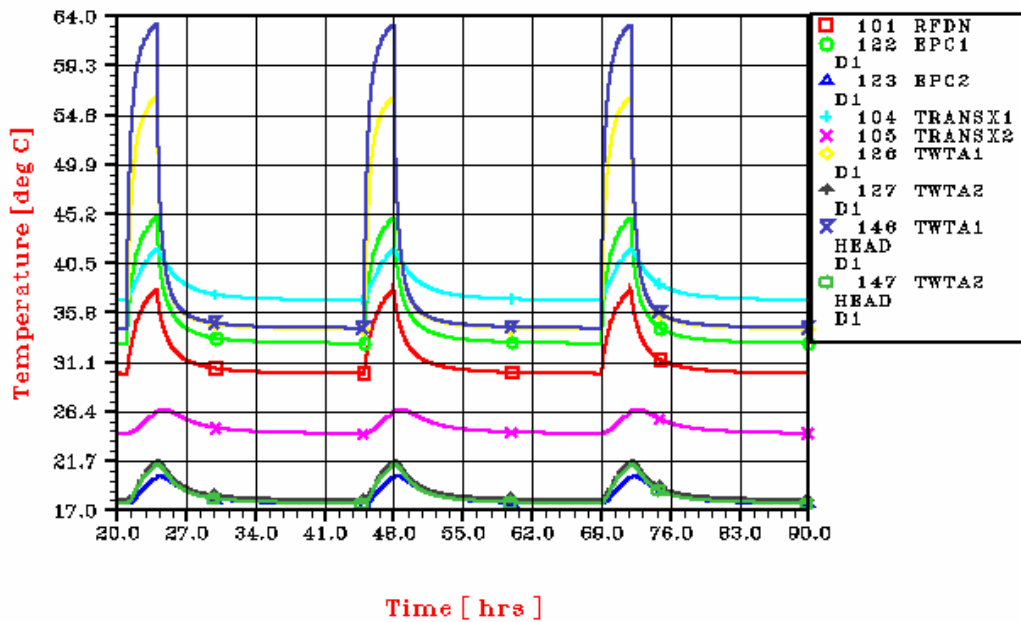

**HERSCHEL HOT CASE B EOL**

**INTERNAL UNITS**

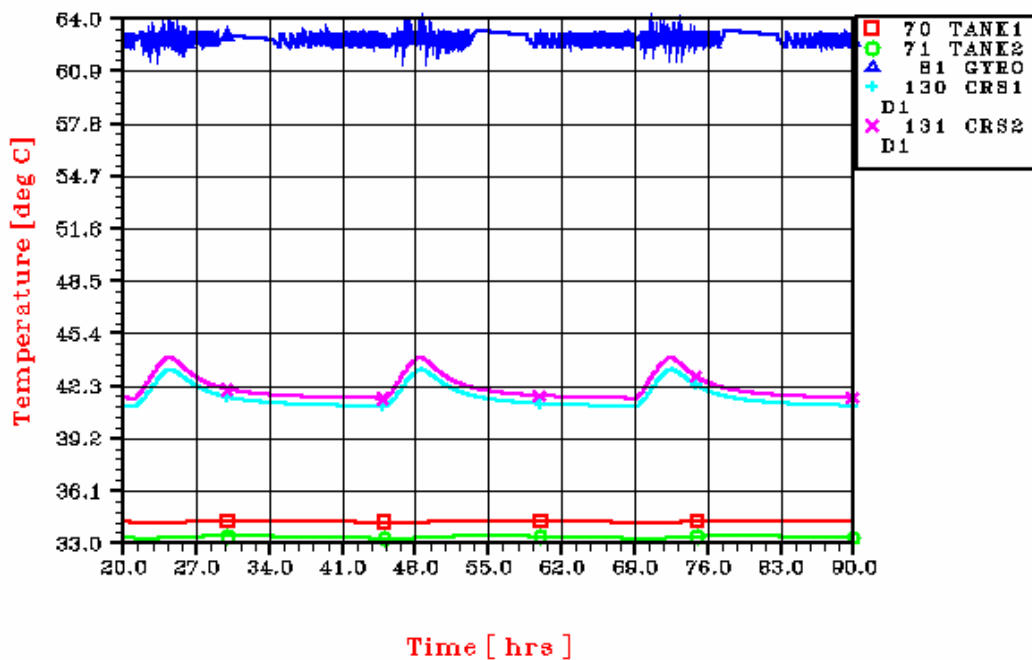

HERSCHEL HOT CASE B EOL

PANEL +Y

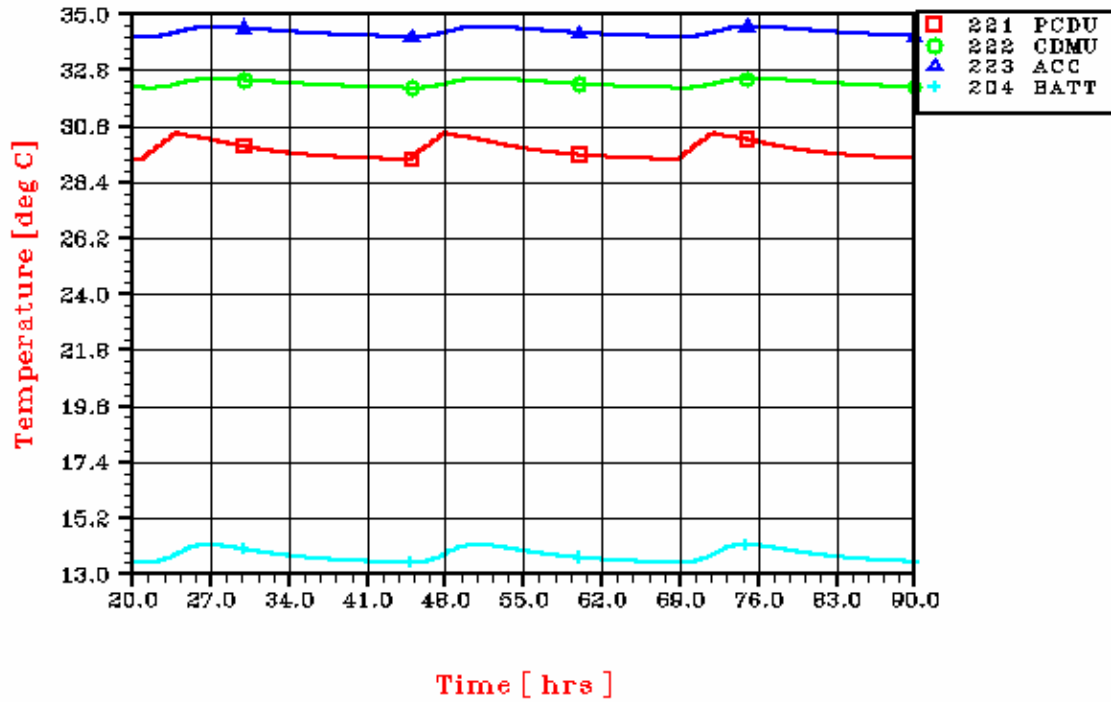

**HERSCHEL HOT CASE B EOL**

**PANEL +Y-Z**

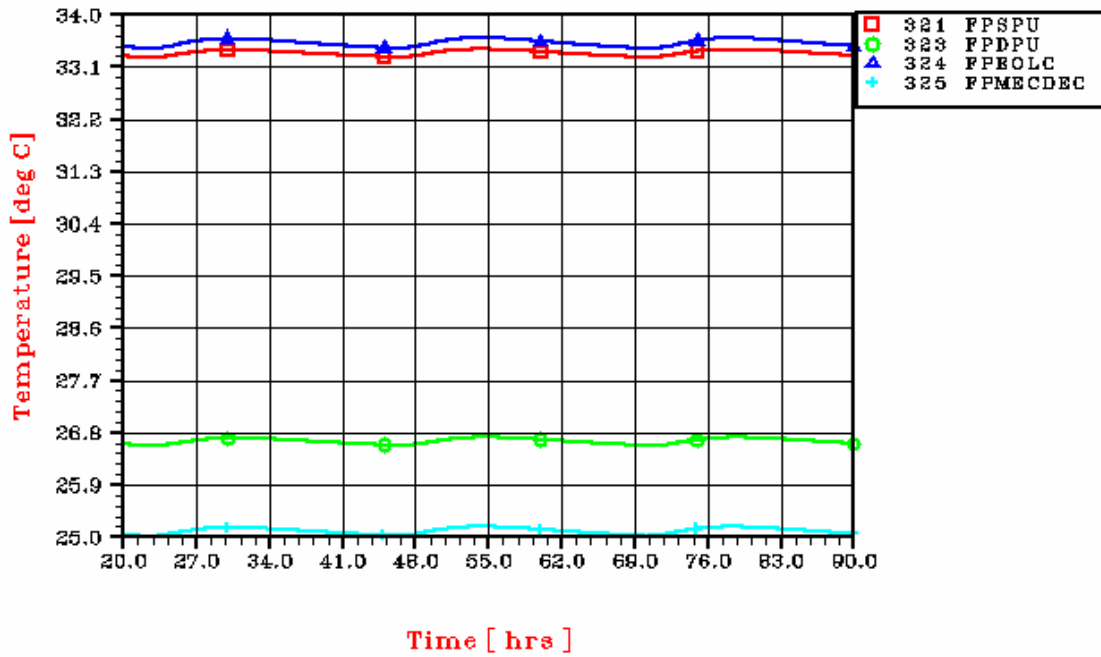

**HERSCHEL HOT CASE B EOL**

**PANEL -Z**

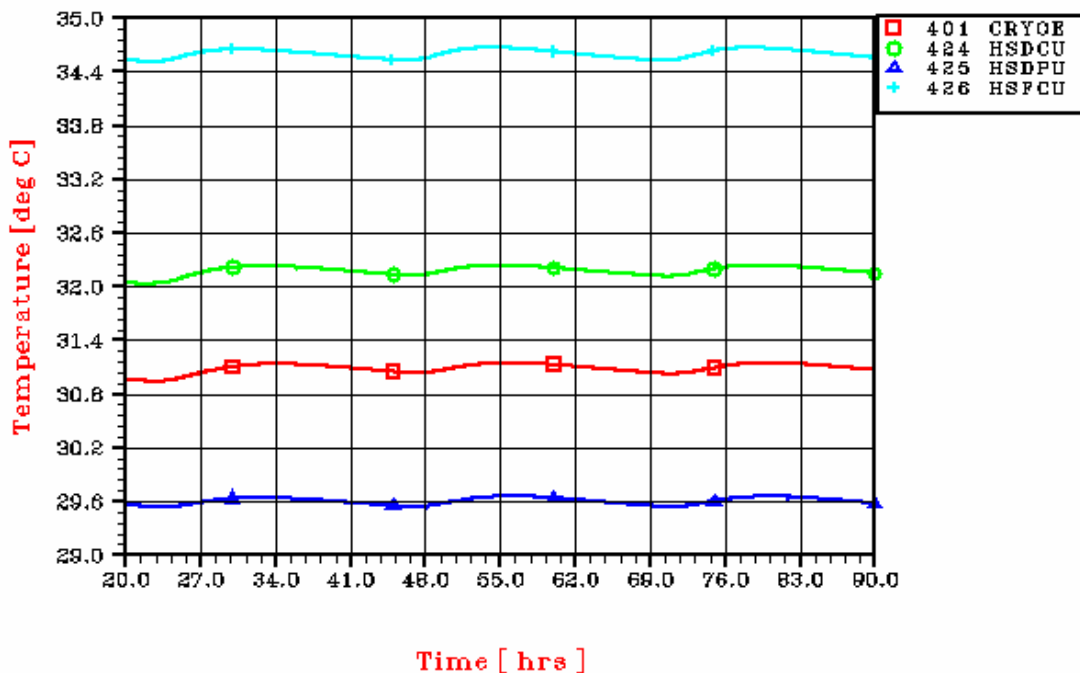

**HERSCHEL HOT CASE B EOL**  
**PANEL -Y-Z**

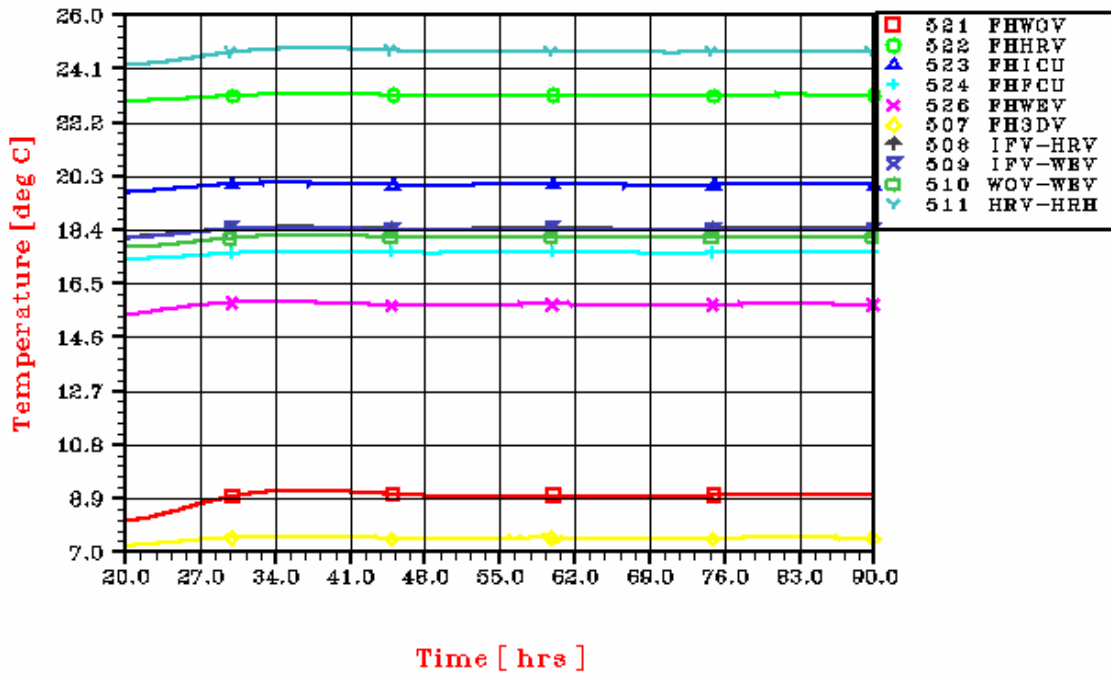

**HERSCHEL HOT CASE B EOL**  
**PANEL -Y**

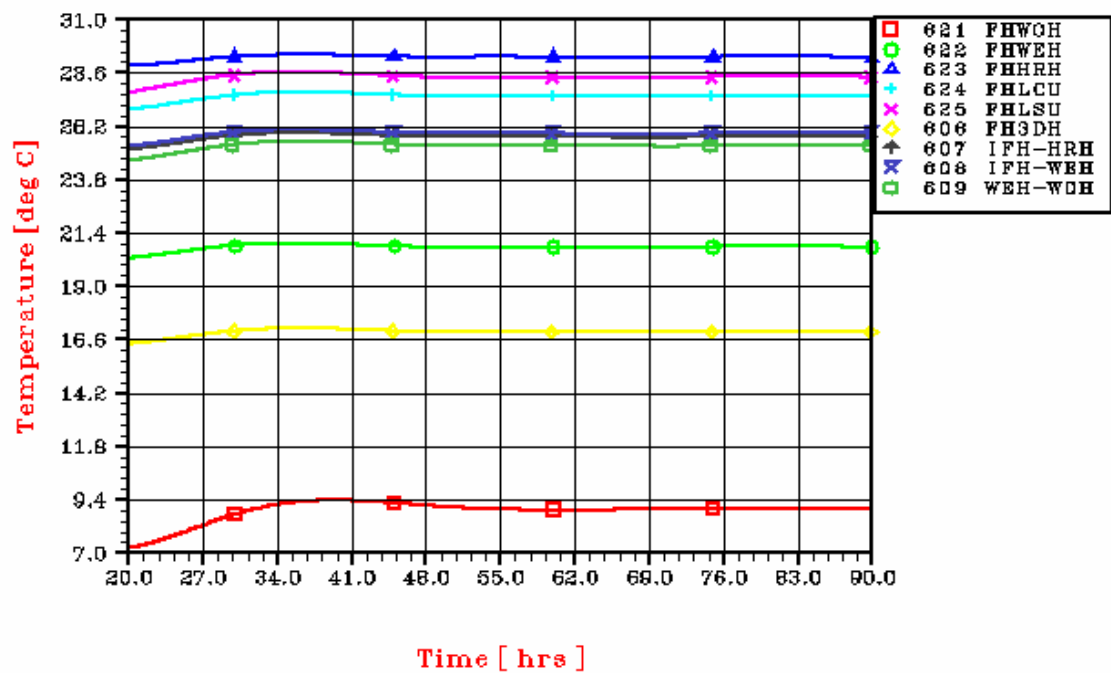



**HERSCHEL HOT CASE B EOL**

**PANEL -Y+Z**

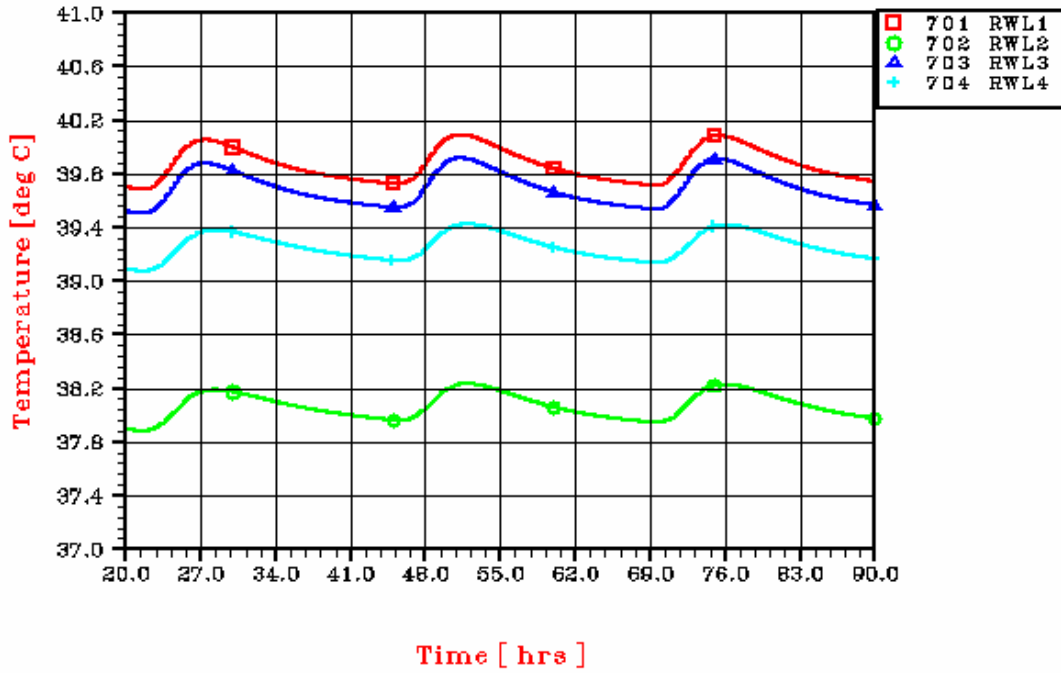

**HERSCHEL HOT CASE B EOL**  
**EXTERNAL UNITS**

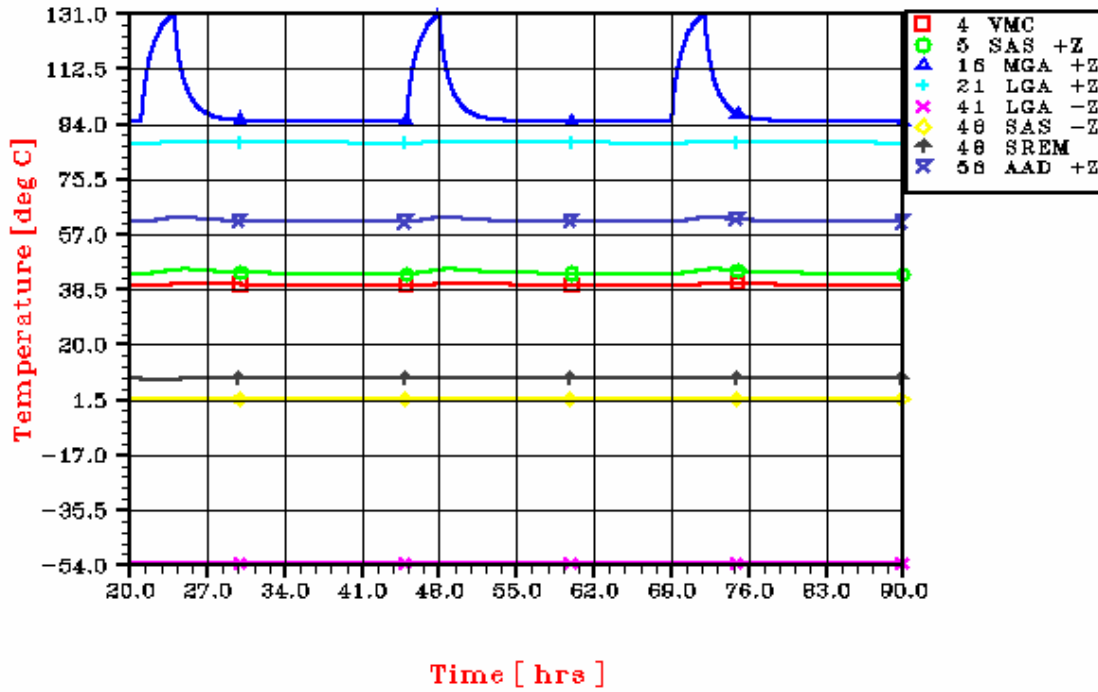

**HERSCHEL HOT CASE B EOL**  
**STR BASEPLATE**

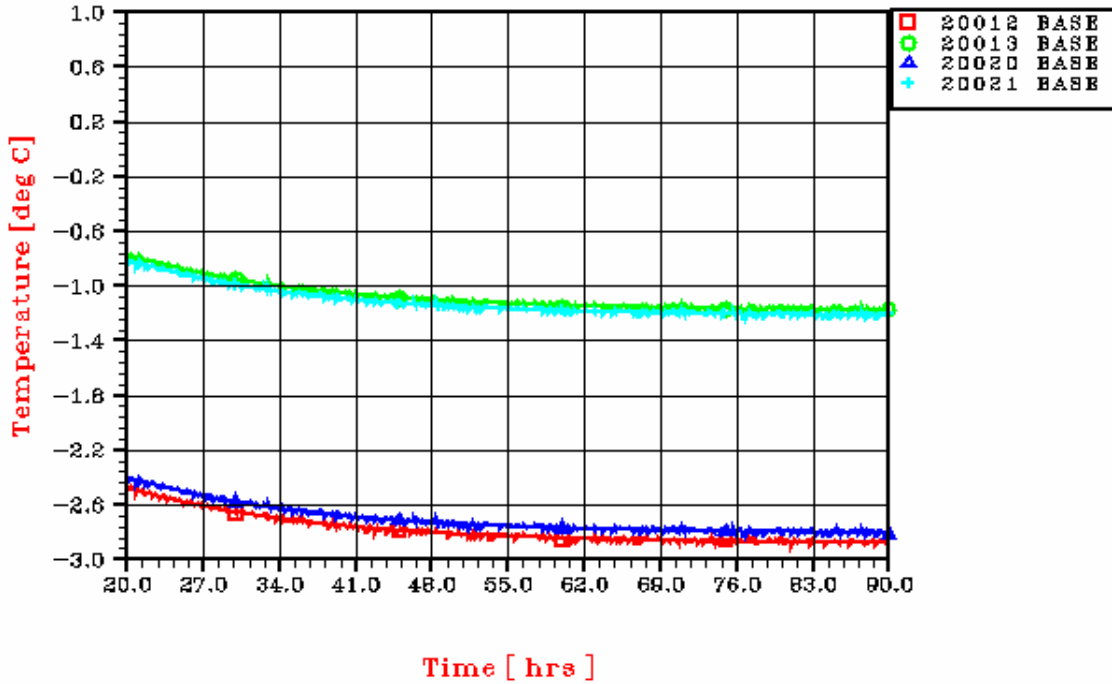

**HERSCHEL HOT CASE B EOL**  
**THRUSTERS MAIN**

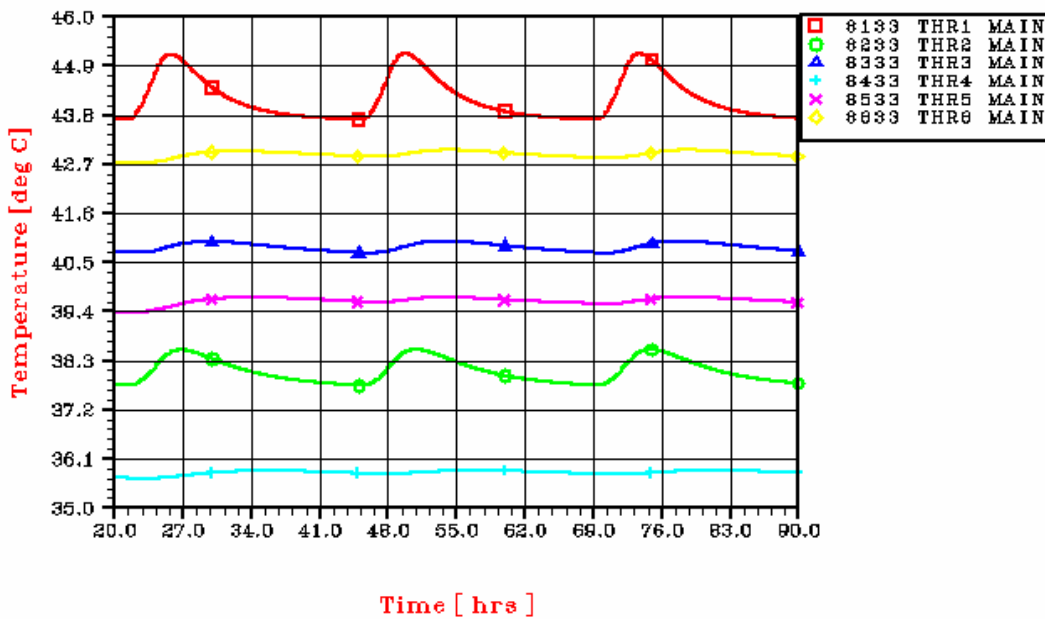

**HERSCHEL HOT CASE B EOL  
 THRUSTERS REDUNDANT**

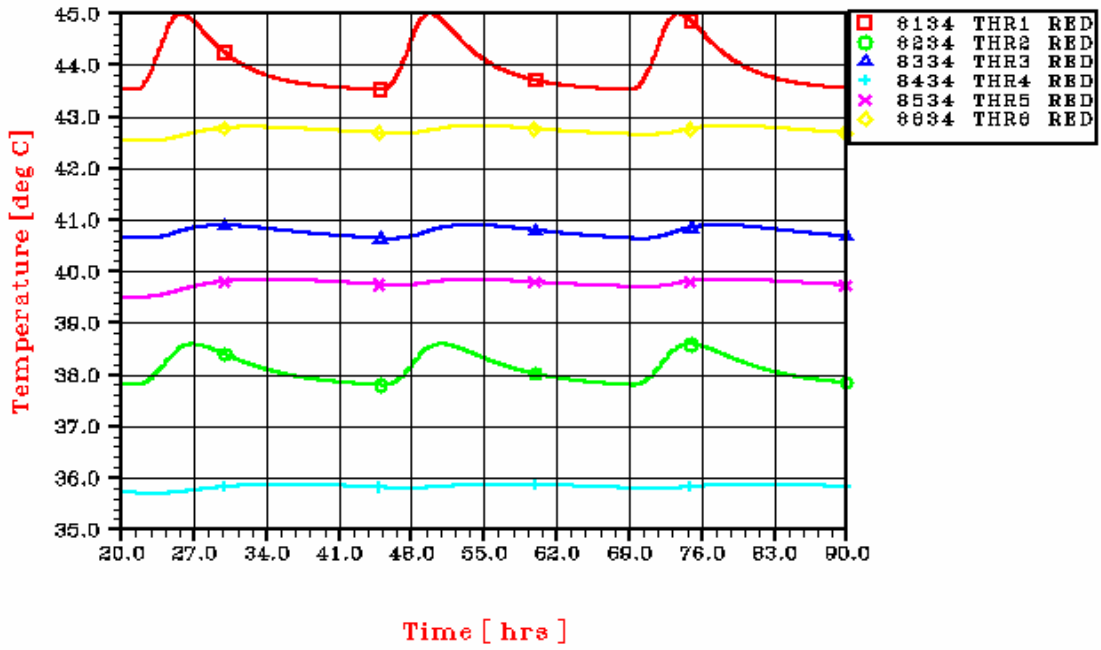

10.2 HERSCHEL RESULTS OF CASE G

**HERSCHEL COLD CASE G BOL**  
**PANEL +Y+Z**

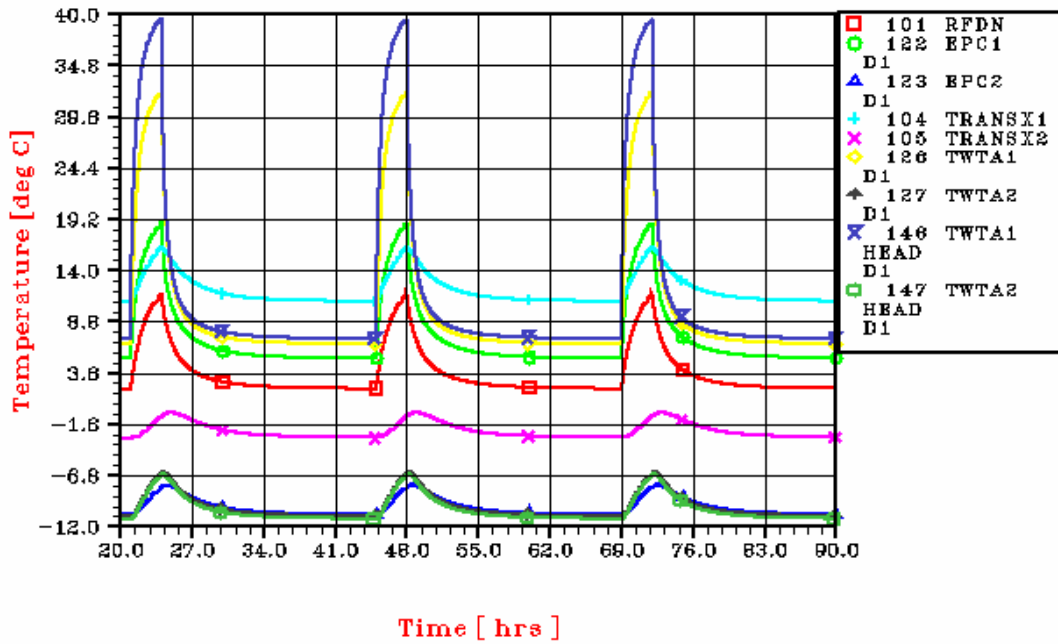

**HERSCHEL COLD CASE G BOL**  
**INTERNAL UNITS**

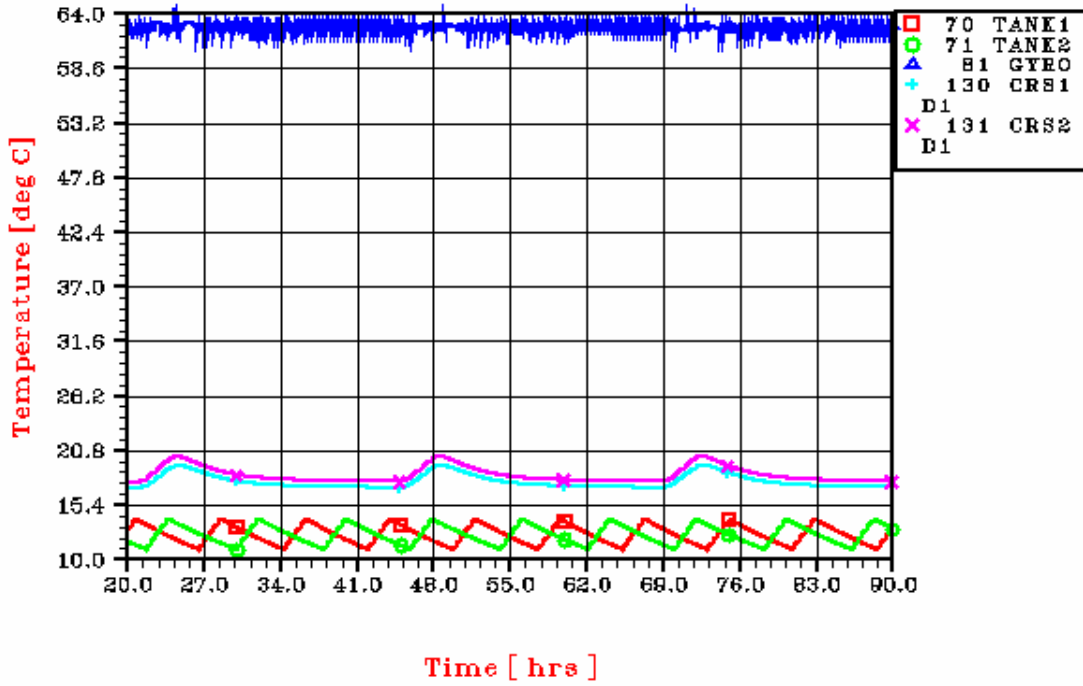

**HERSCHEL COLD CASE G BOL**

**PANEL +Y**

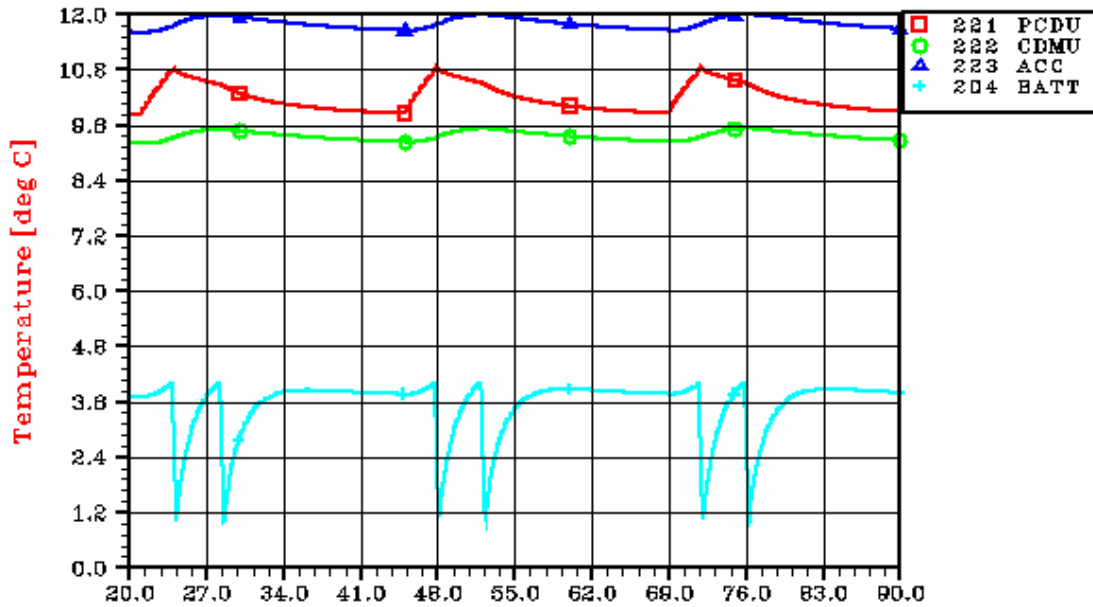

Time [ hrs ]

**HERSCHEL COLD CASE G BOL**

**PANEL +Y-Z**

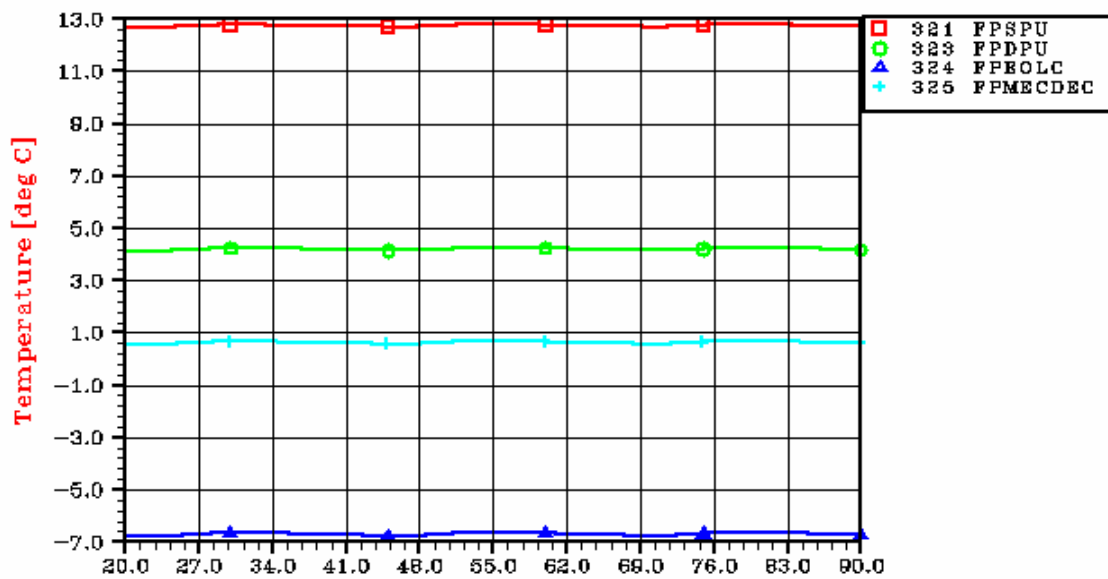

Time [ hrs ]

HERSCHEL COLD CASE G BOL  
PANEL -Z

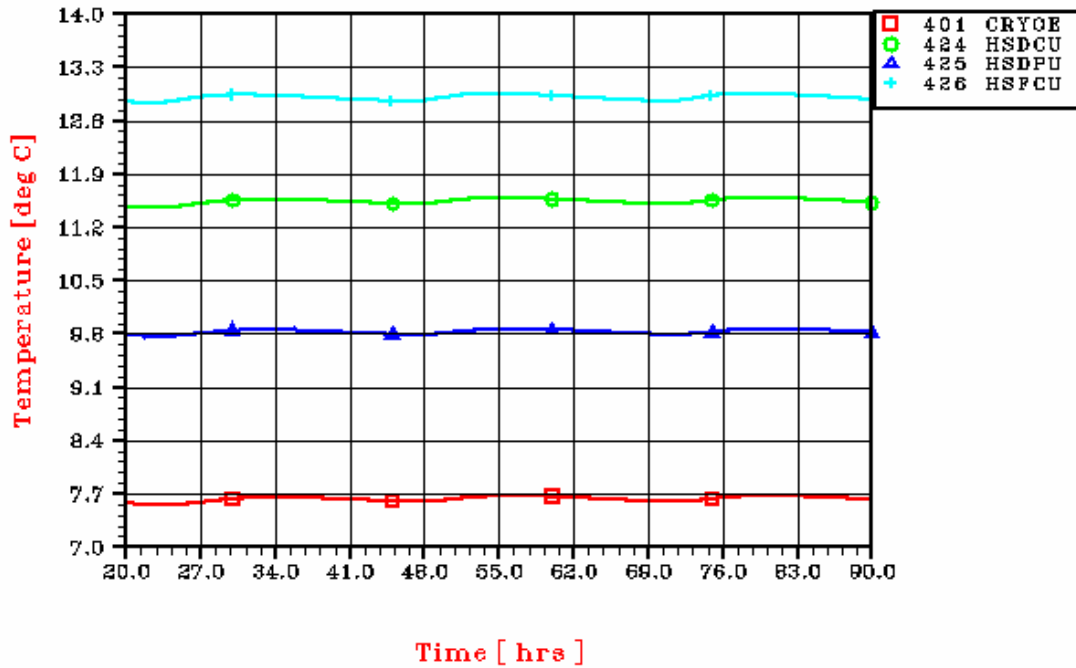

HERSCHEL COLD CASE G BOL  
PANEL -Y-Z

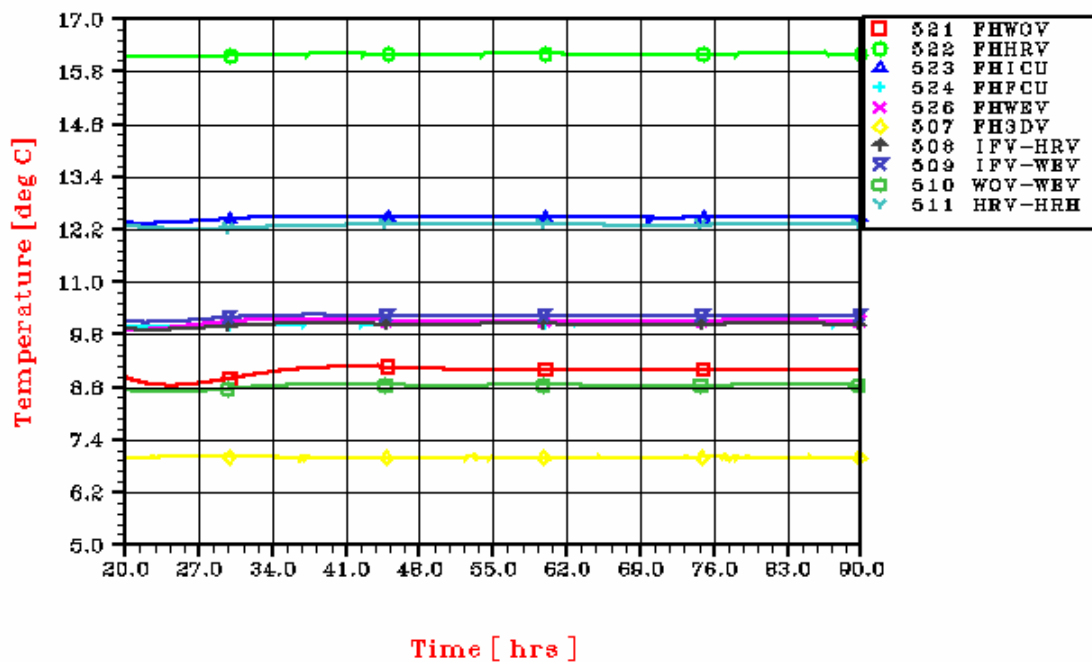



HERSCHEL COLD CASE G BOL

PANEL -Y

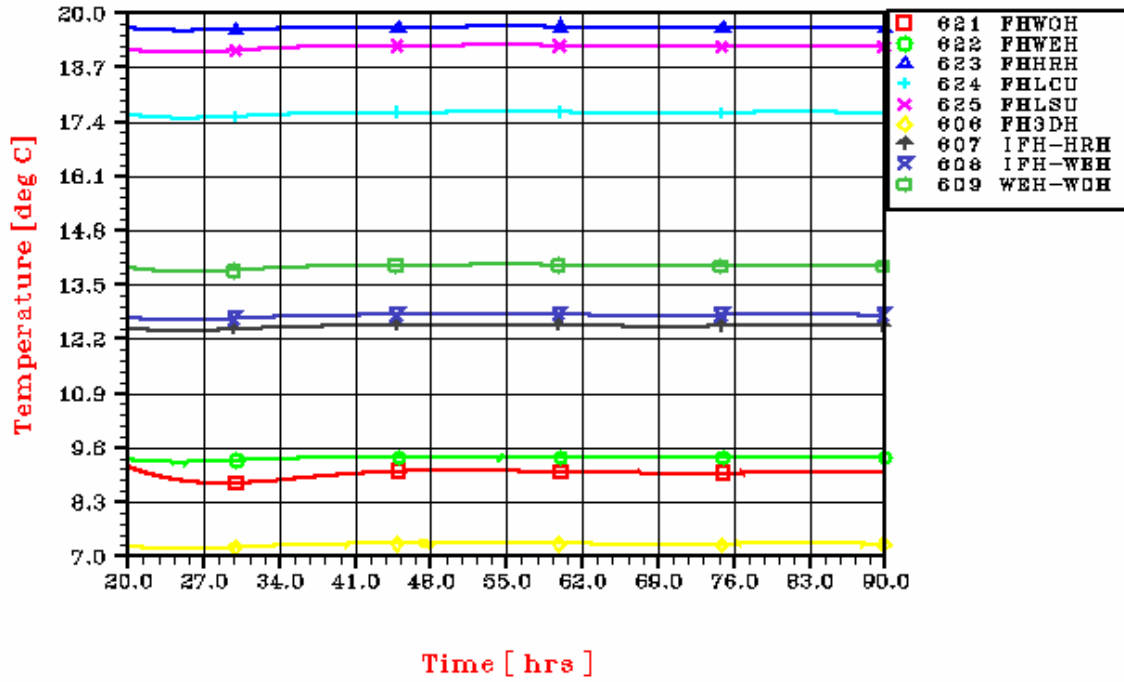

## HERSCHEL COLD CASE G BOL

### PANEL -Y+Z

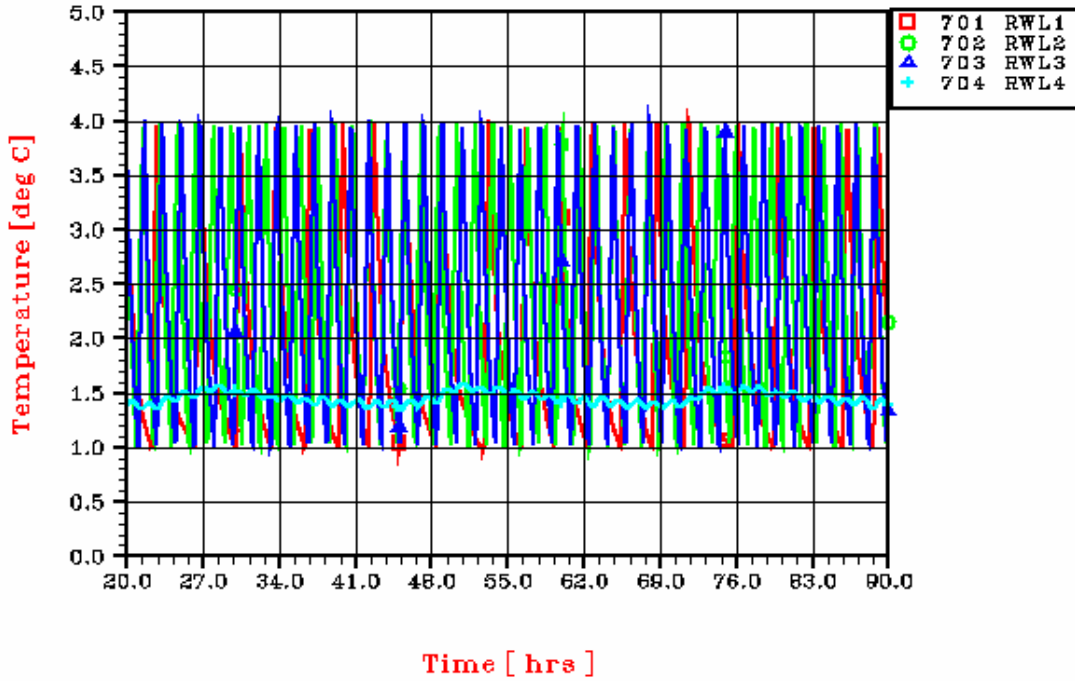

**HERSCHEL COLD CASE G BOL**  
**EXTERNAL UNITS**

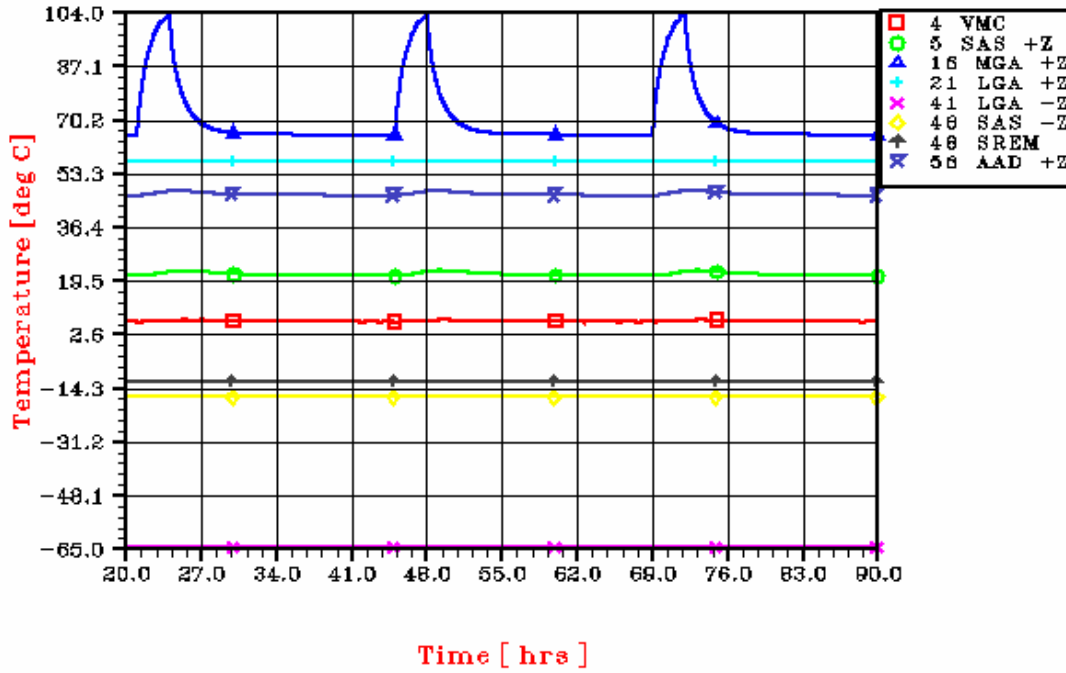

**HERSCHEL COLD CASE G BOL**  
**STR BASEPLATE**

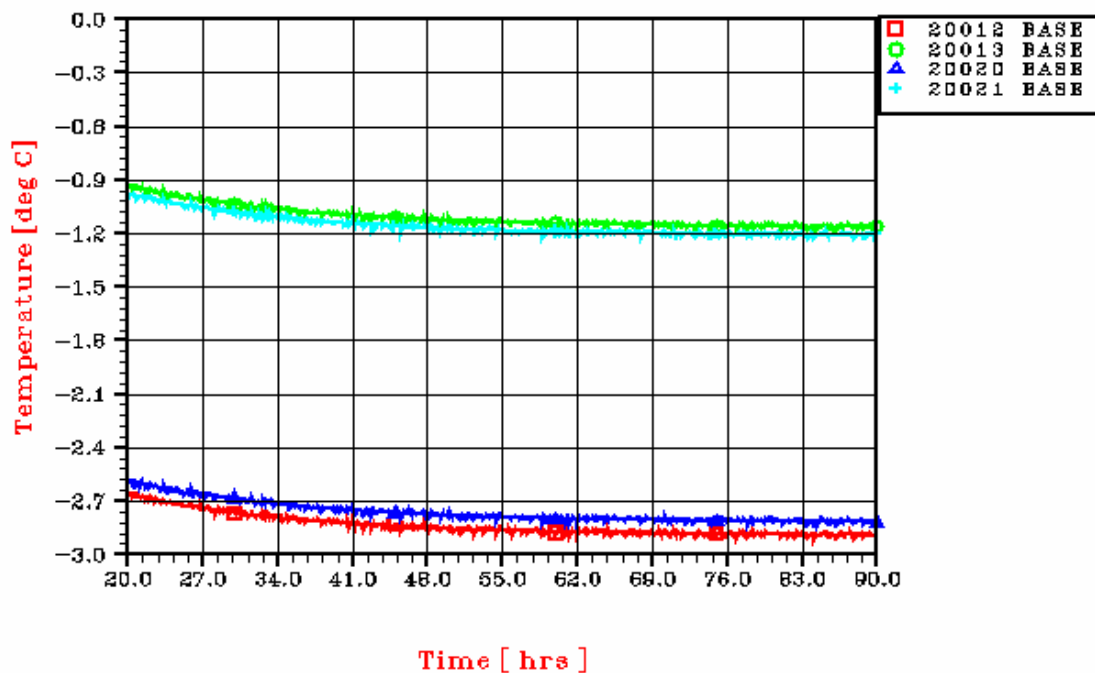

**HERSCHEL COLD CASE G BOL**  
**THRUSTERS MAIN**

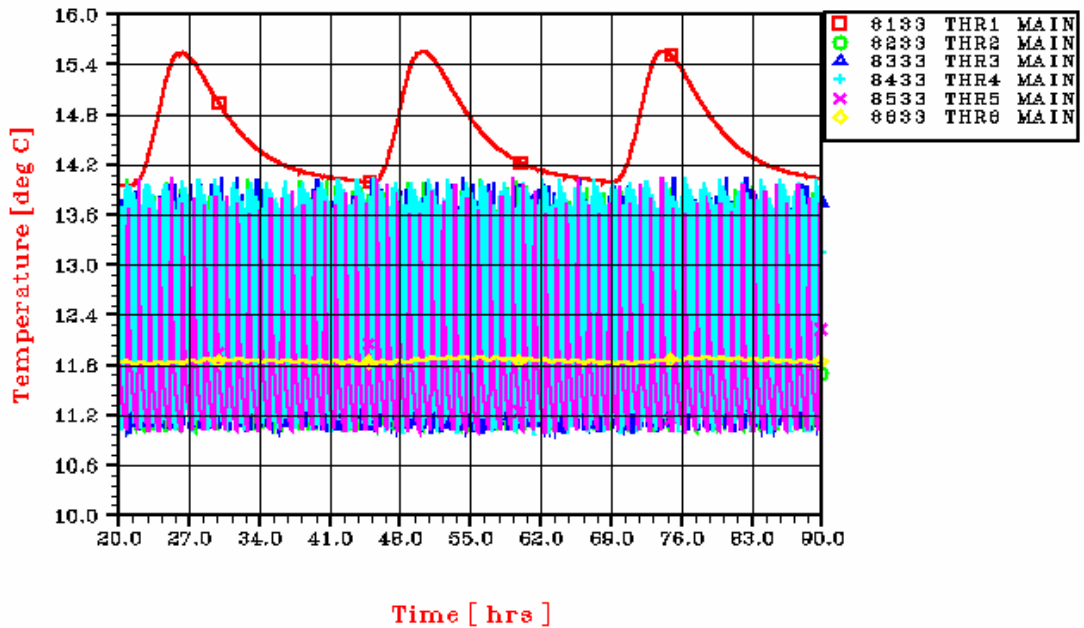

**HERSCHEL COLD CASE G BOL**  
**THRUSTERS REDUNDANT**

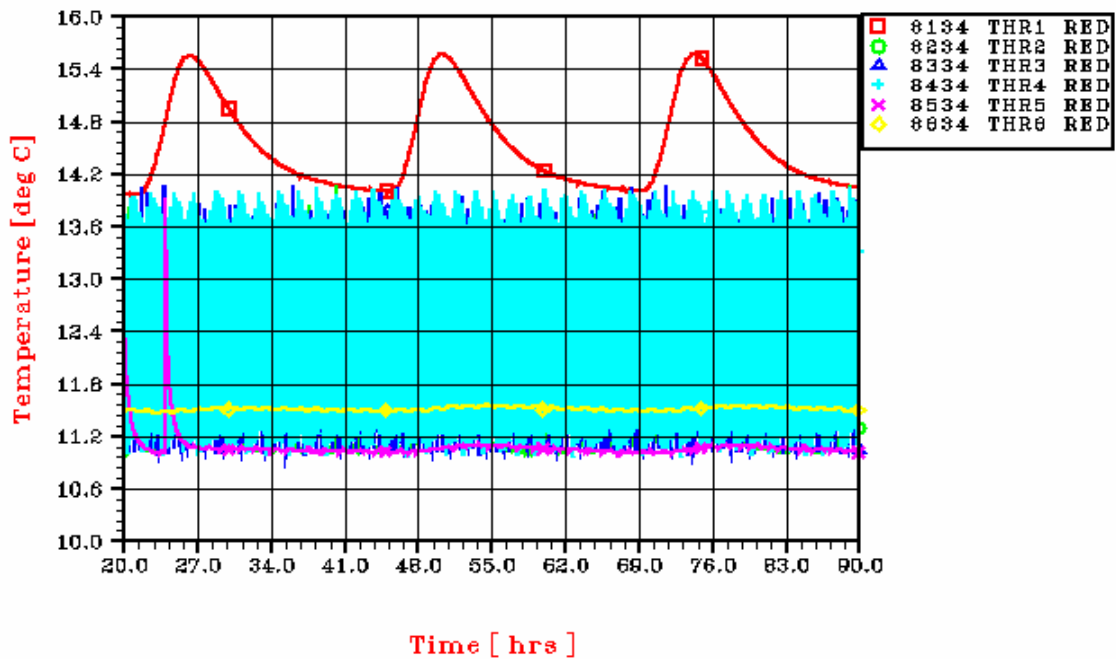

10.3 HERSCHEL RESULTS OF CASE I

HERSCHEL COLD CASE I BOL  
PANEL +Y+Z

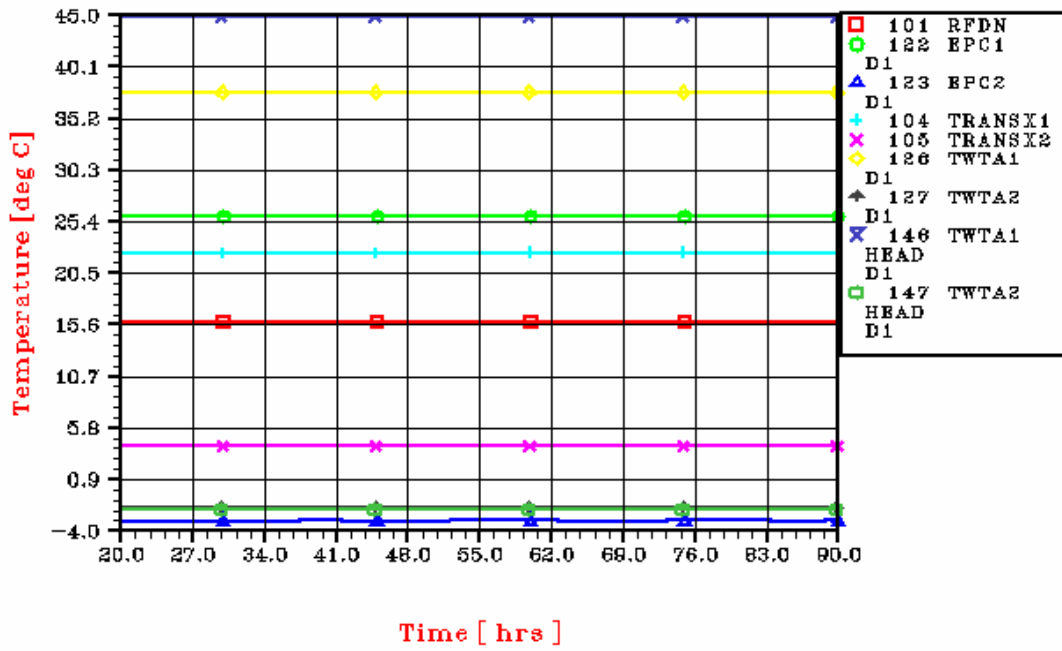

**HERSCHEL COLD CASE I BOL**  
**INTERNAL UNITS**

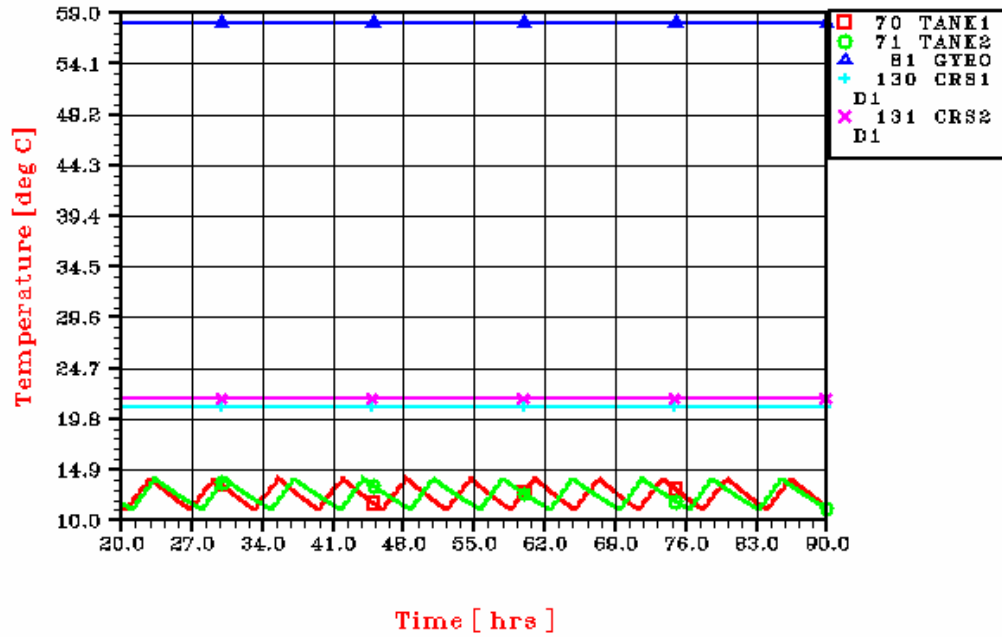

HERSCHEL COLD CASE I BOL

PANEL +Y

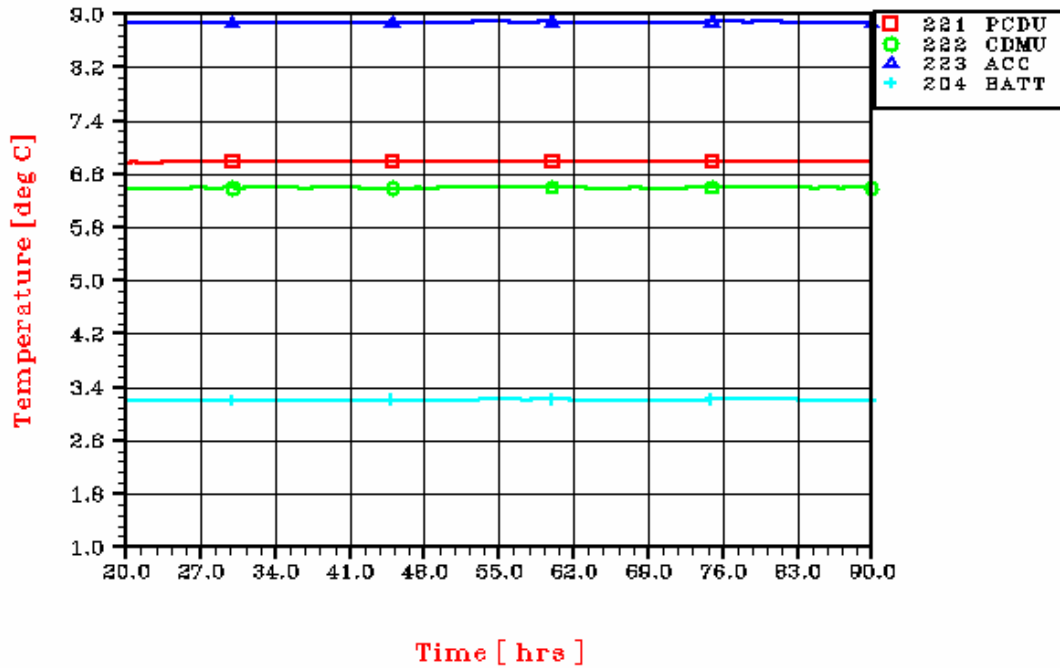

HERSCHEL COLD CASE I BOL

PANEL +Y-Z

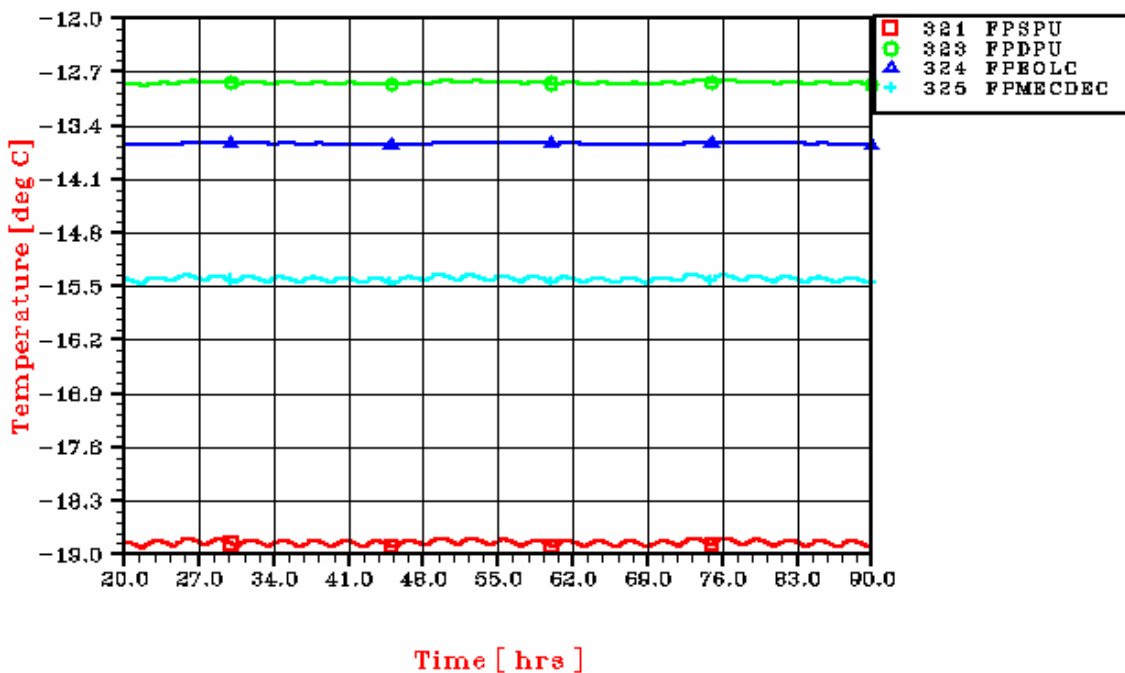

HERSCHEL COLD CASE I BOL  
PANEL -Z

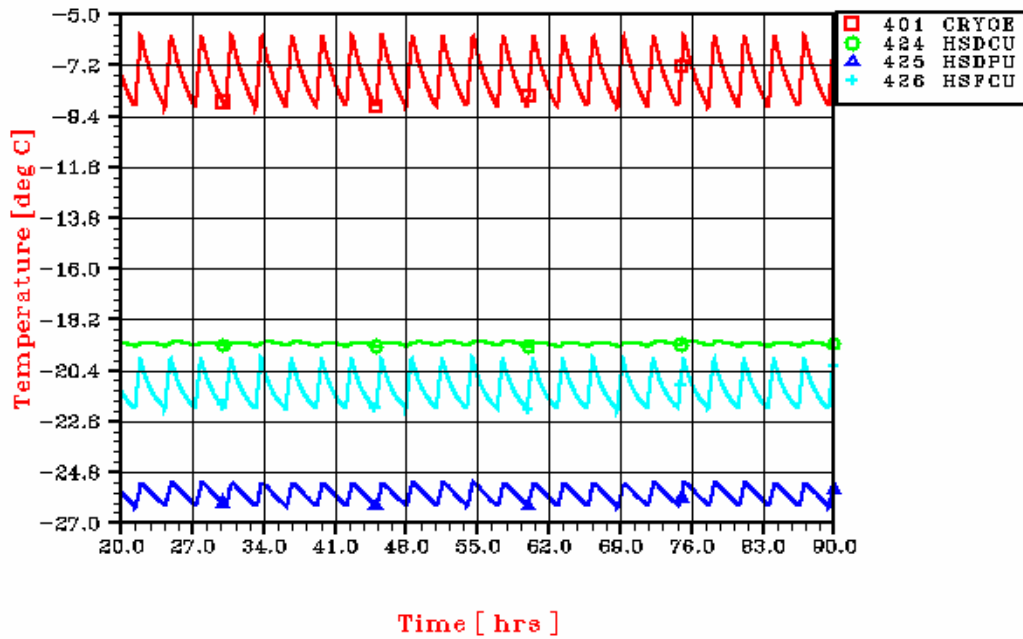

HERSCHEL COLD CASE I BOL  
PANEL -Y-Z

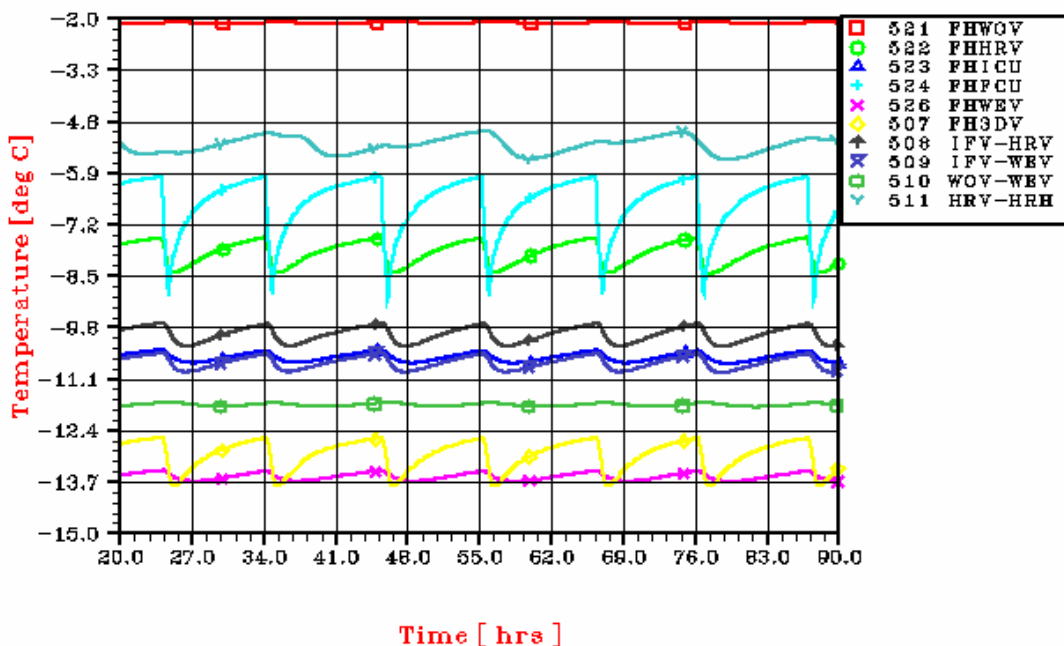



**HERSCHEL COLD CASE I BOL**

**PANEL -Y**

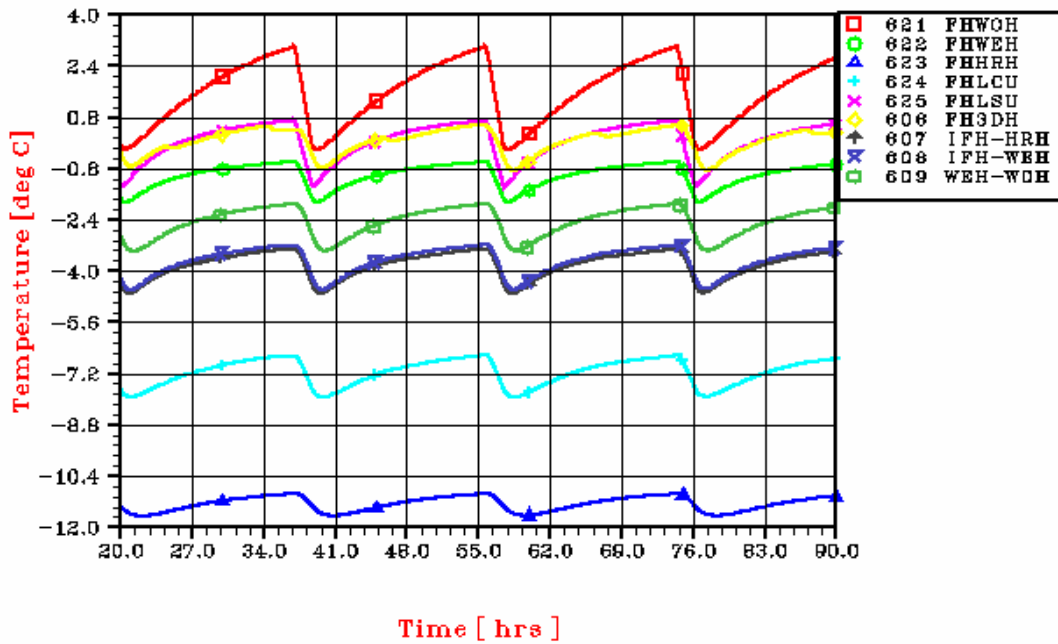

**HERSCHEL COLD CASE I BOL**

**PANEL -Y+Z**

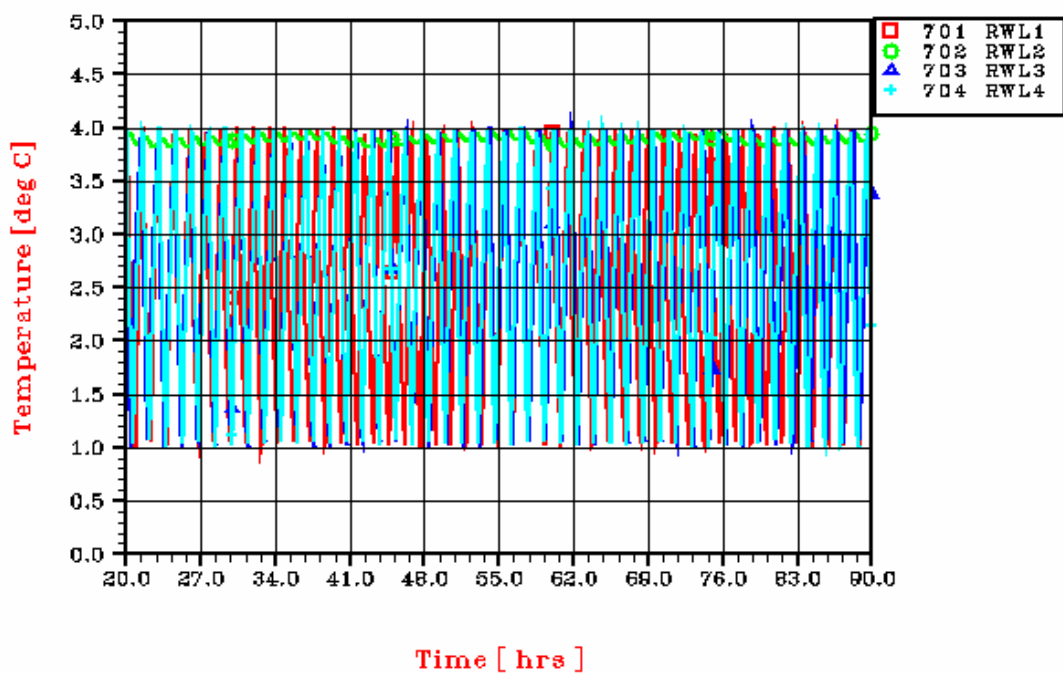

**HERSCHEL COLD CASE I BOL**  
**EXTERNAL UNITS**

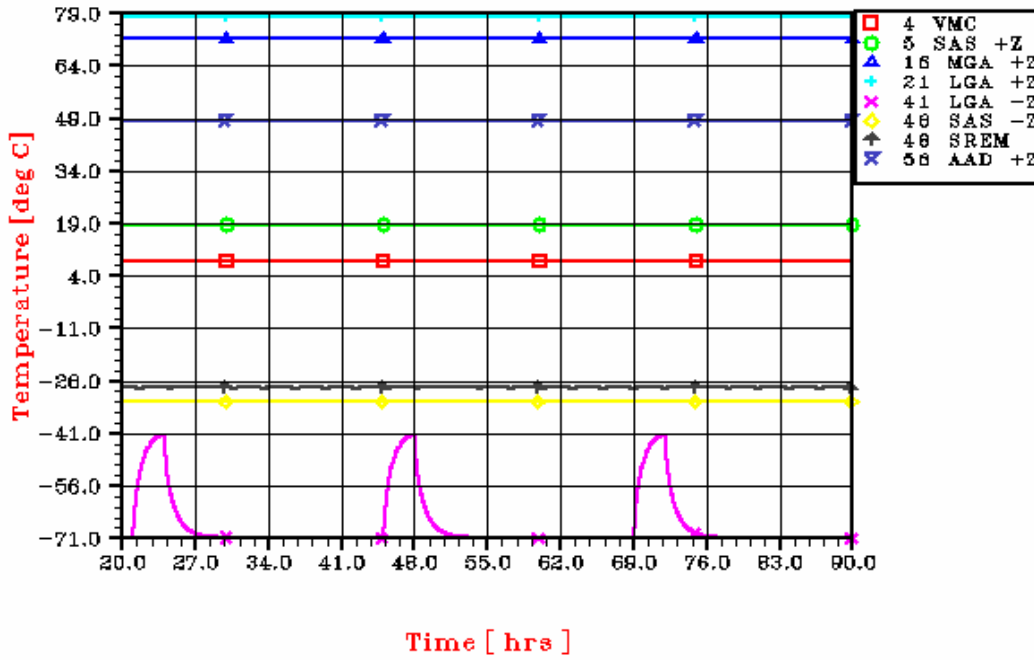

**HERSCHEL COLD CASE I BOL**  
**STR BASEPLATE**

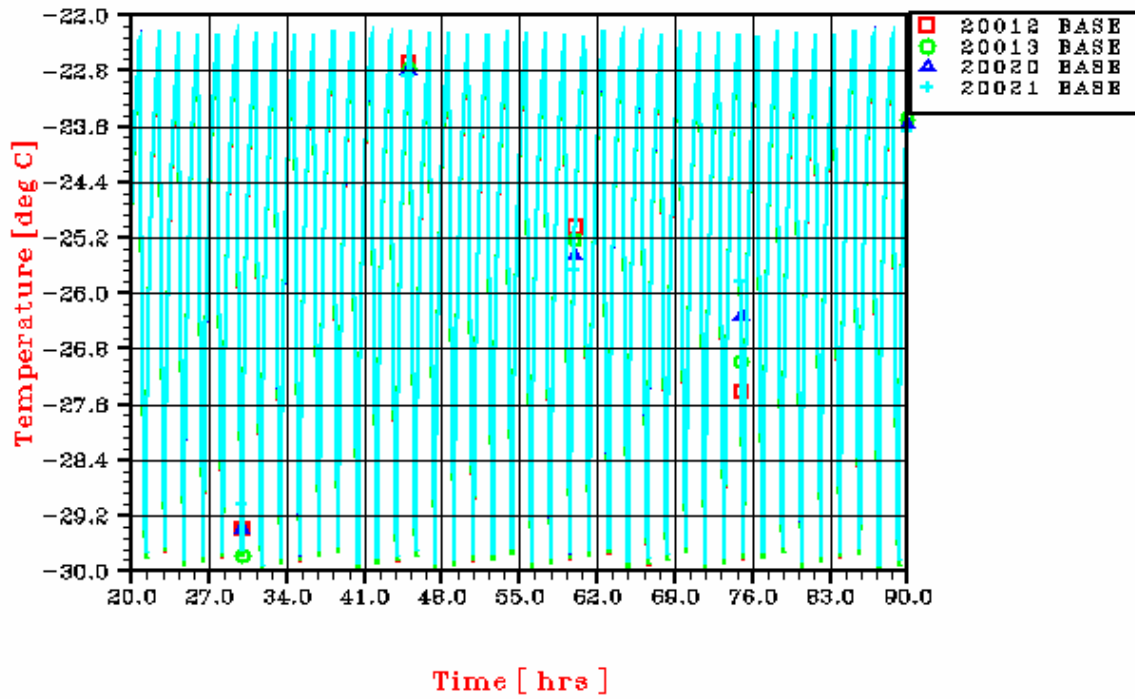

HERSCHEL COLD CASE I BOL  
THRUSTERS MAIN

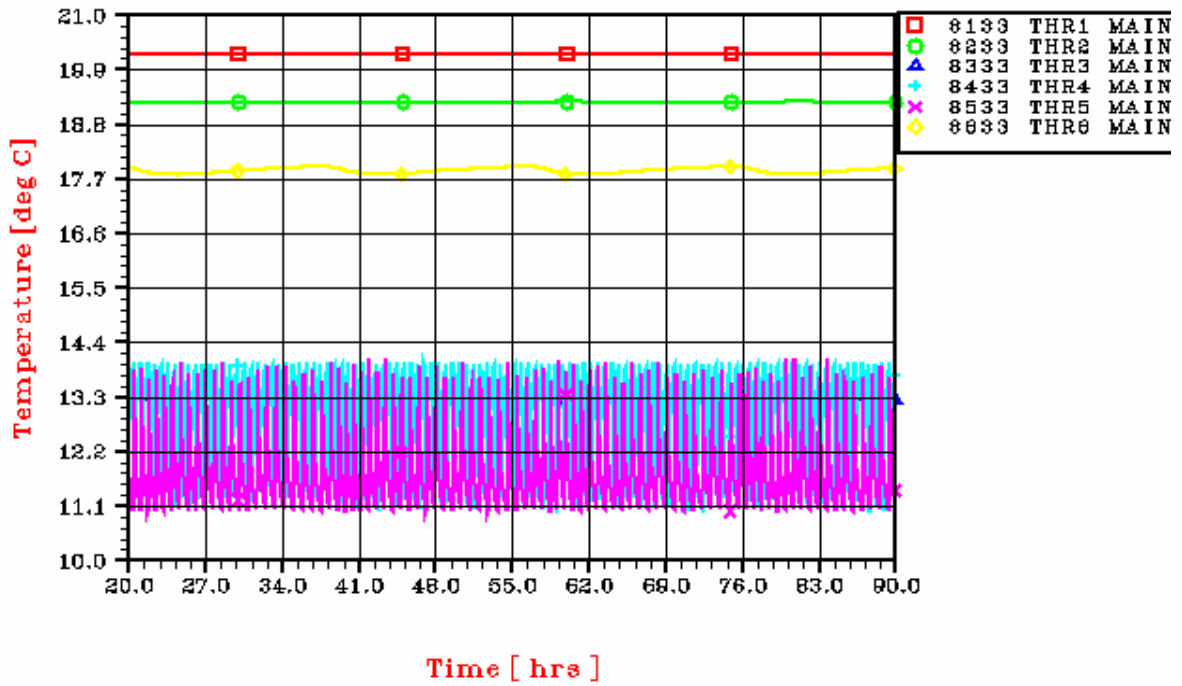

**HERSCHEL COLD CASE I BOL**  
**THRUSTERS REDUNDANT**

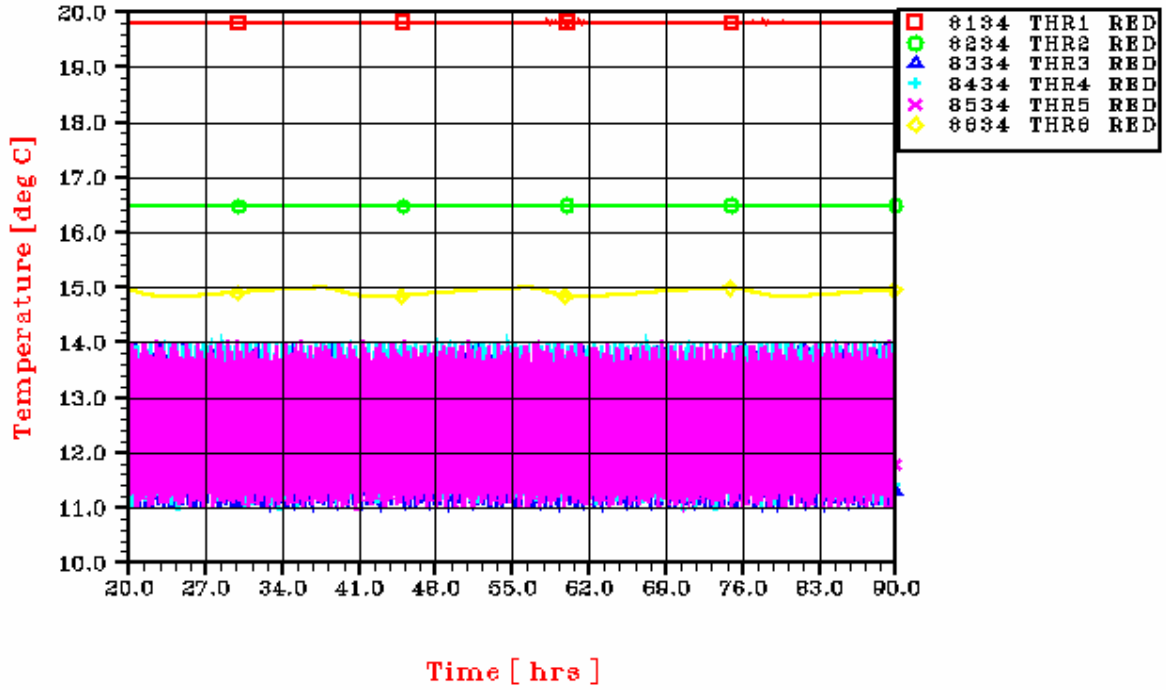

10.4 HERSCHEL RESULTS OF CASE P

HERSCHEL TRANSIENT CASE P BOL

PANEL +Y+Z

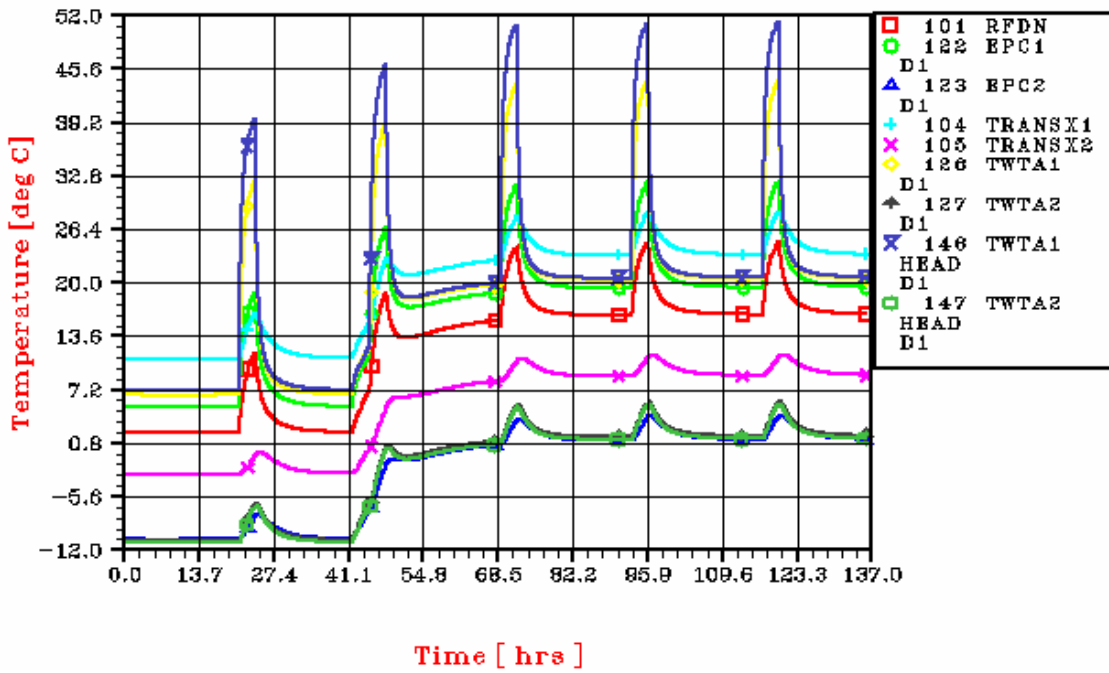

**HERSCHEL TRANSIENT CASE P BOL**  
**INTERNAL UNITS**

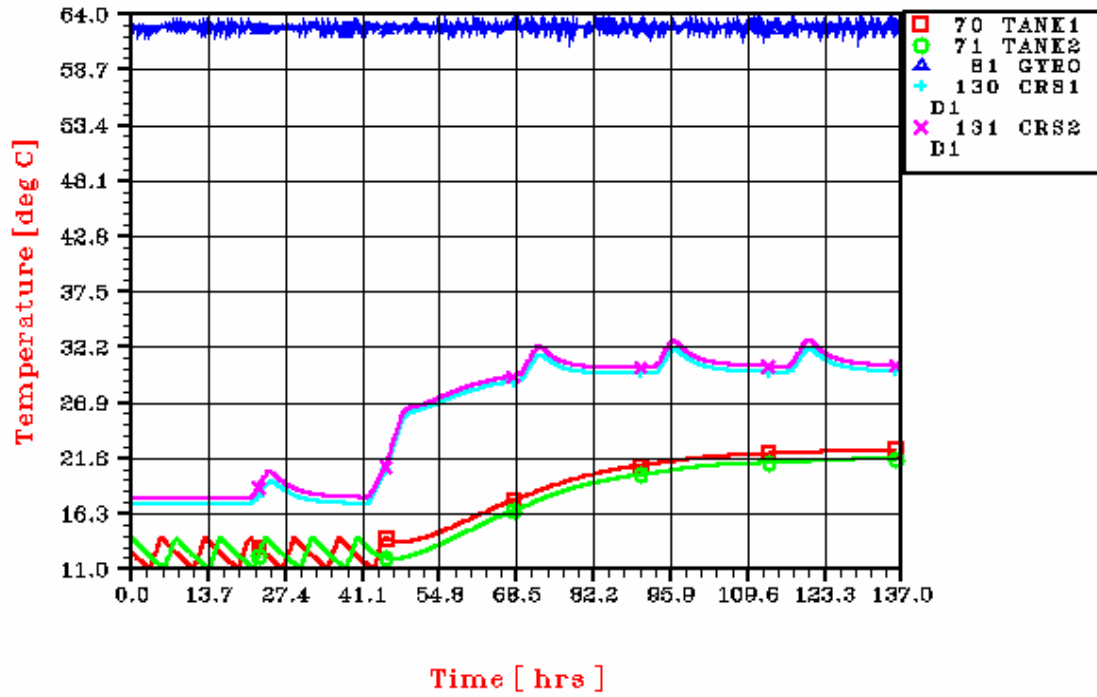

HERSCHEL TRANSIENT CASE P BOL

PANEL +Y

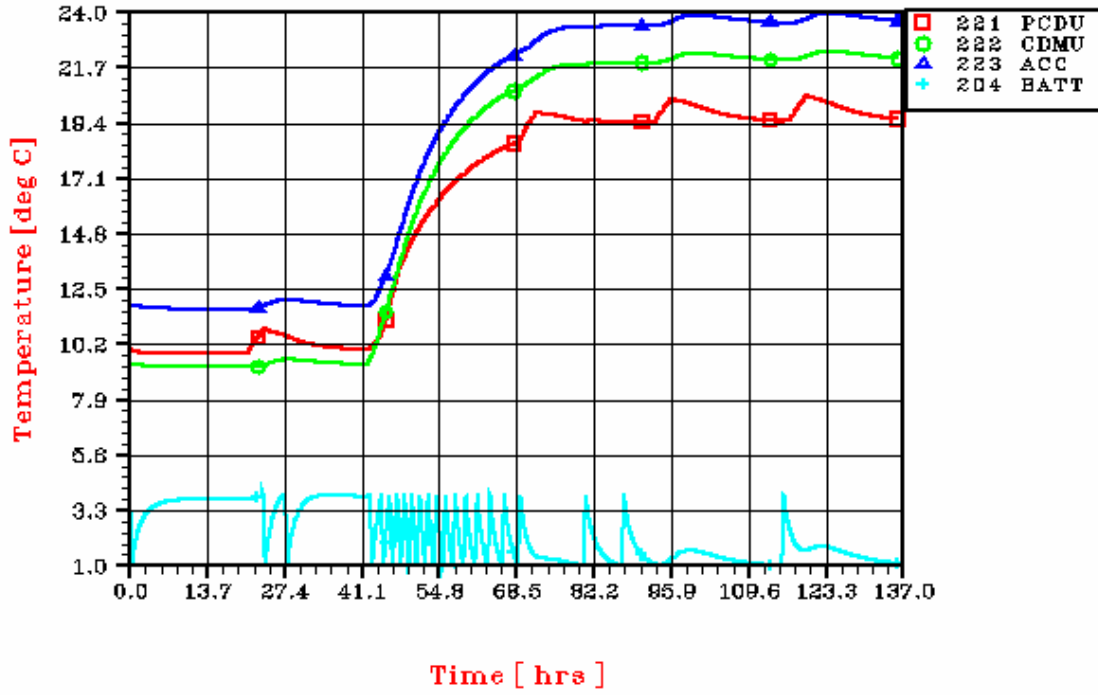



HERSCHEL TRANSIENT CASE P BOL

PANEL +Y-Z

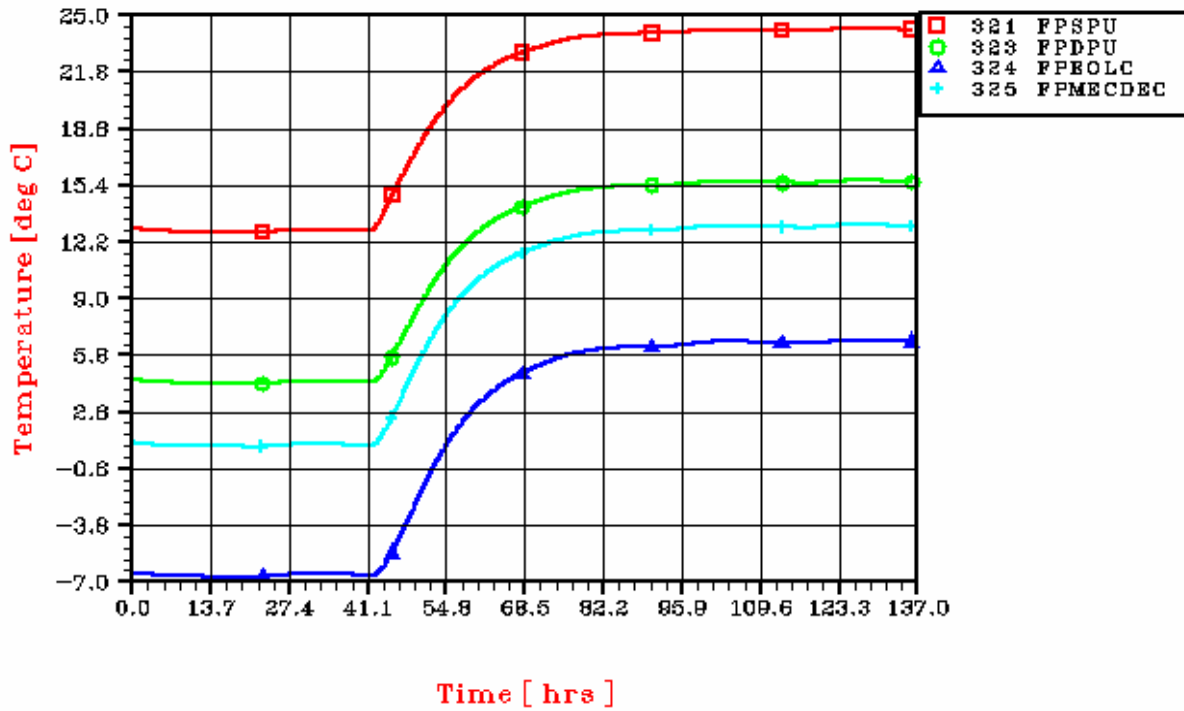

HERSCHEL TRANSIENT CASE P BOL  
PANEL -Z

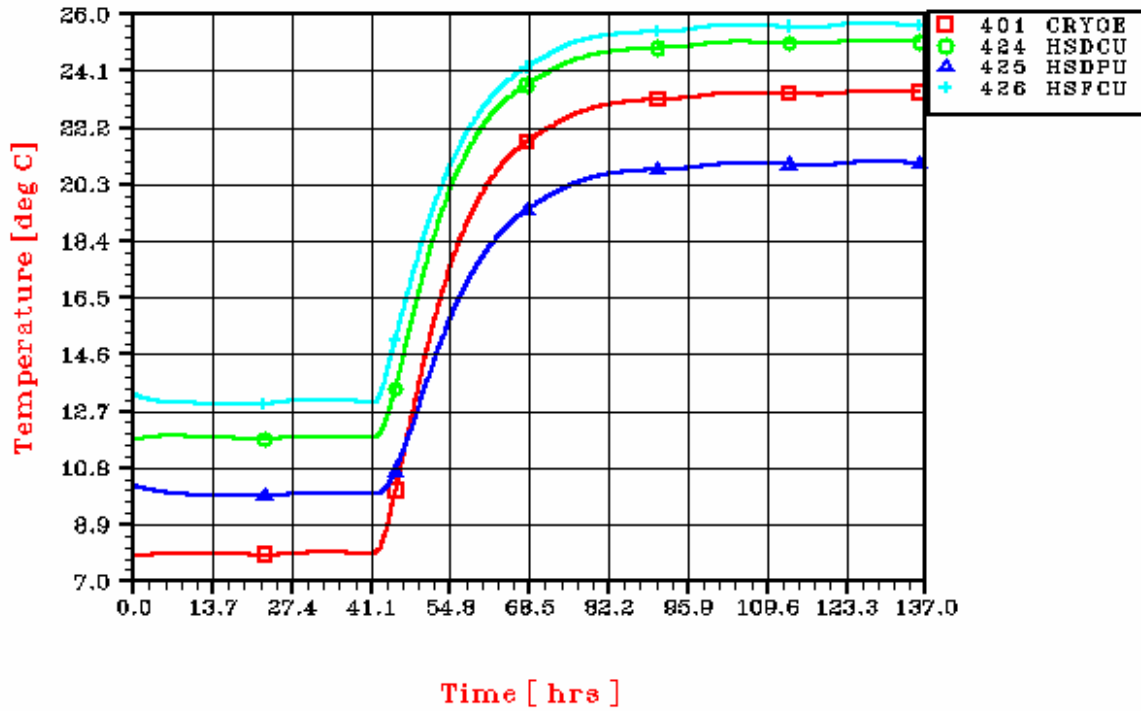

**HERSCHEL TRANSIENT CASE P BOL**  
**PANEL -Y-Z**

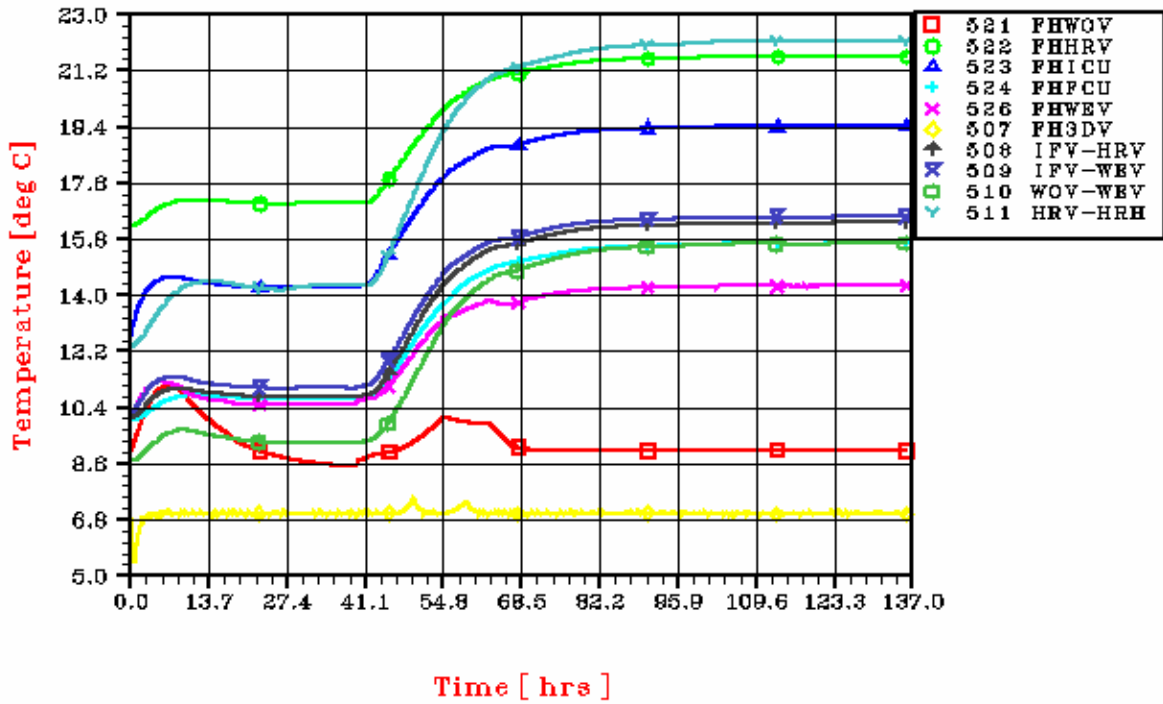



**HERSCHEL TRANSIENT CASE P BOL**  
**PANEL -Y+Z**

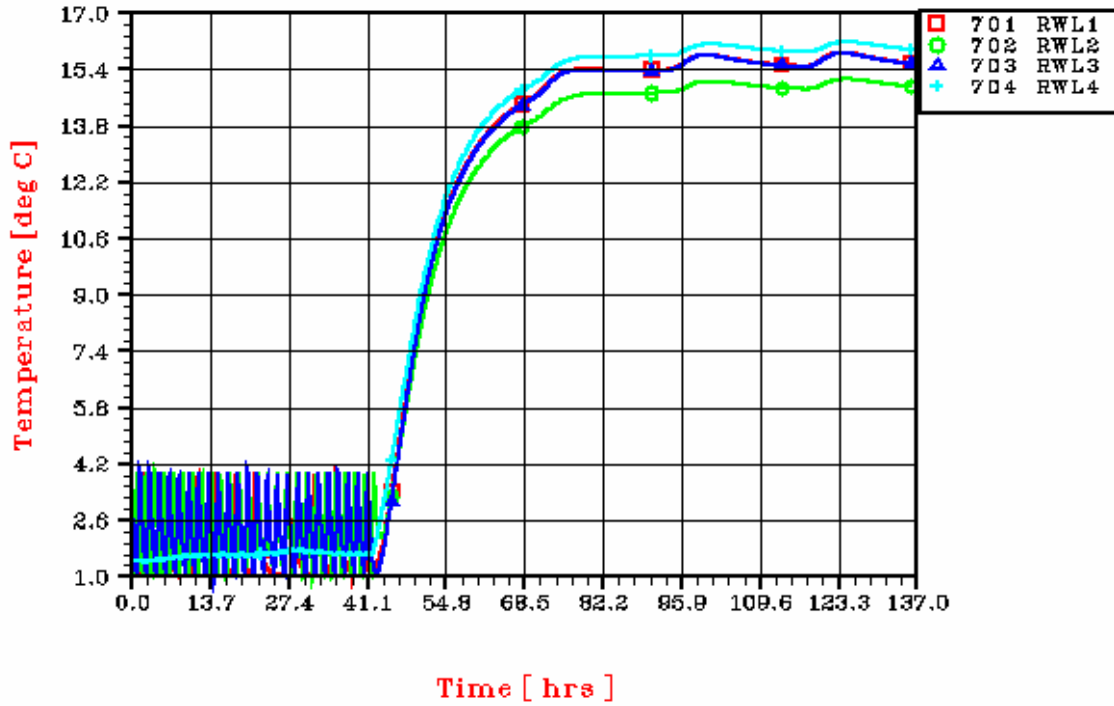

**HERSCHEL TRANSIENT CASE P BOL**  
**EXTERNAL UNITS**

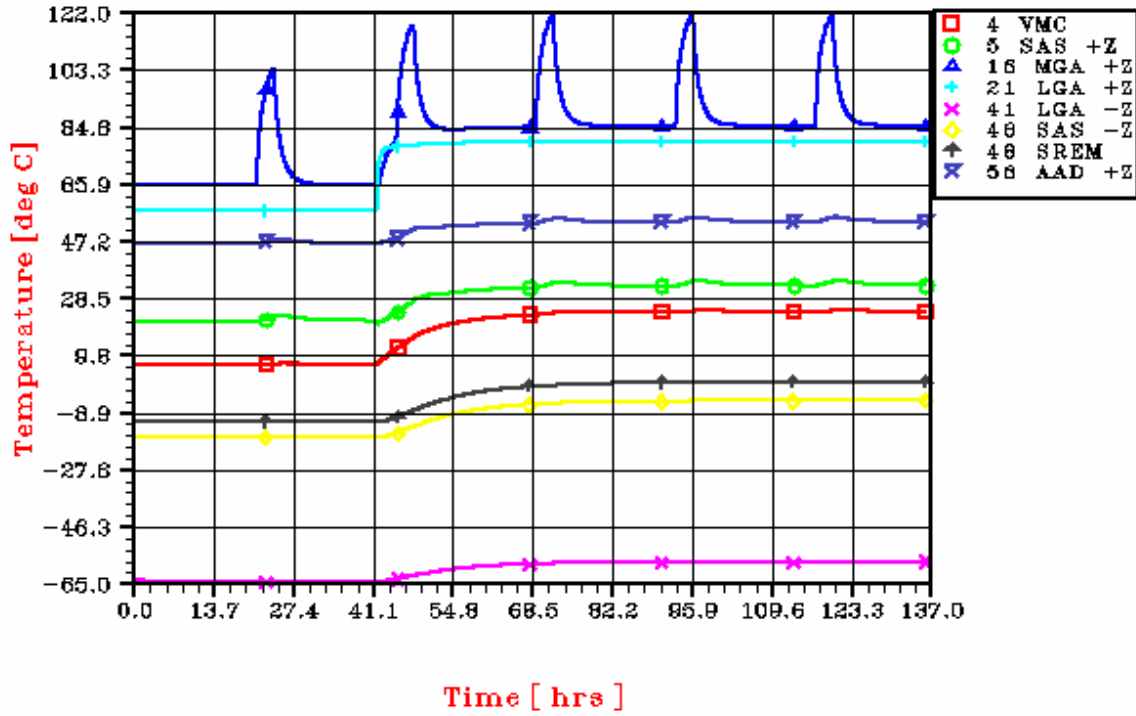

**HERSCHEL TRANSIENT CASE P BOL**  
**STR BASEPLATE**

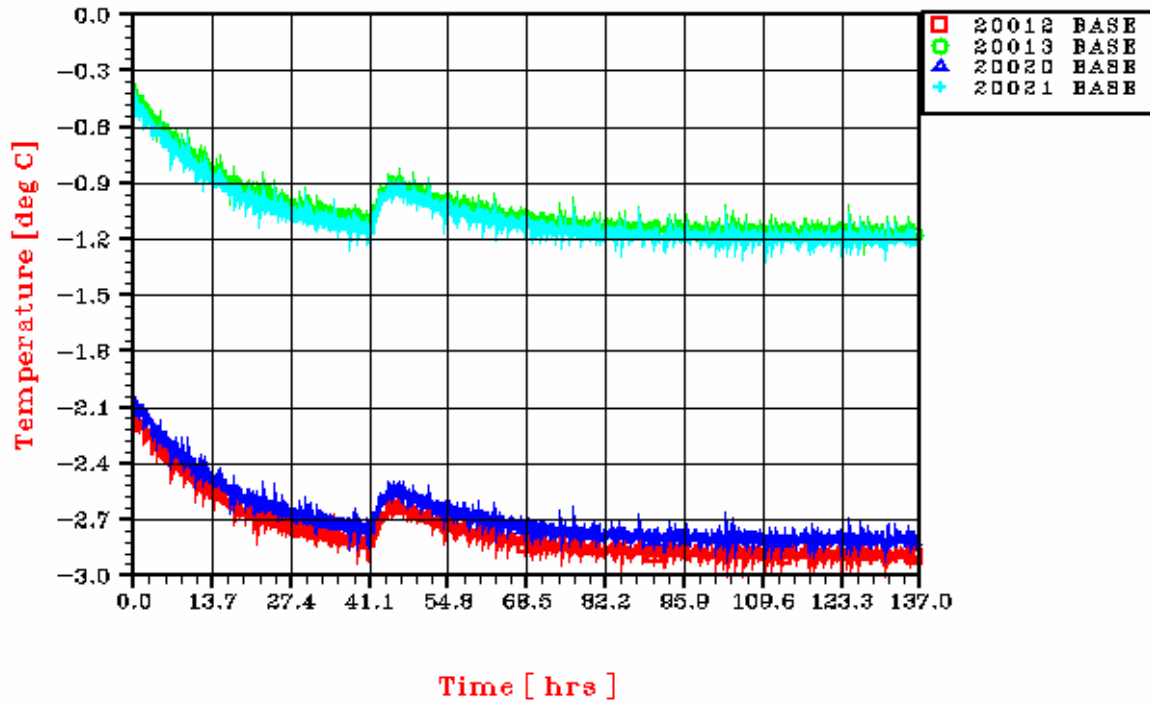

**HERSCHEL TRANSIENT CASE P BOL**  
**THRUSTERS MAIN**

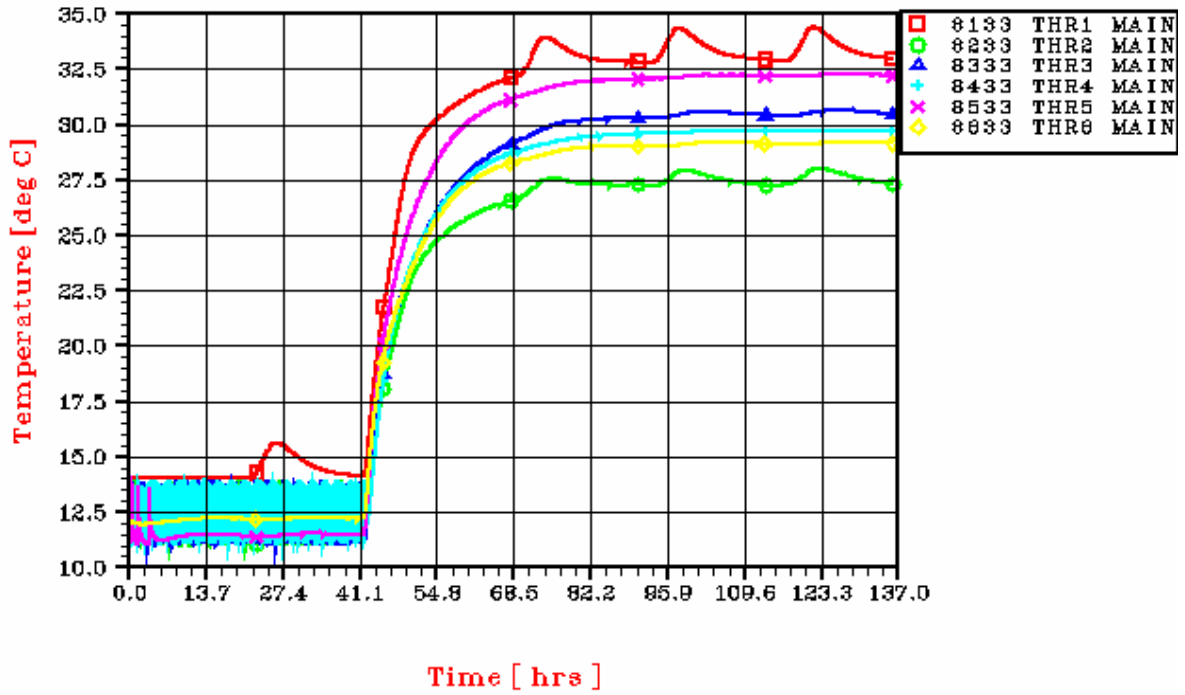



**HERSCHEL TRANSIENT CASE P BOL**  
**THRUSTERS REDUNDANT**

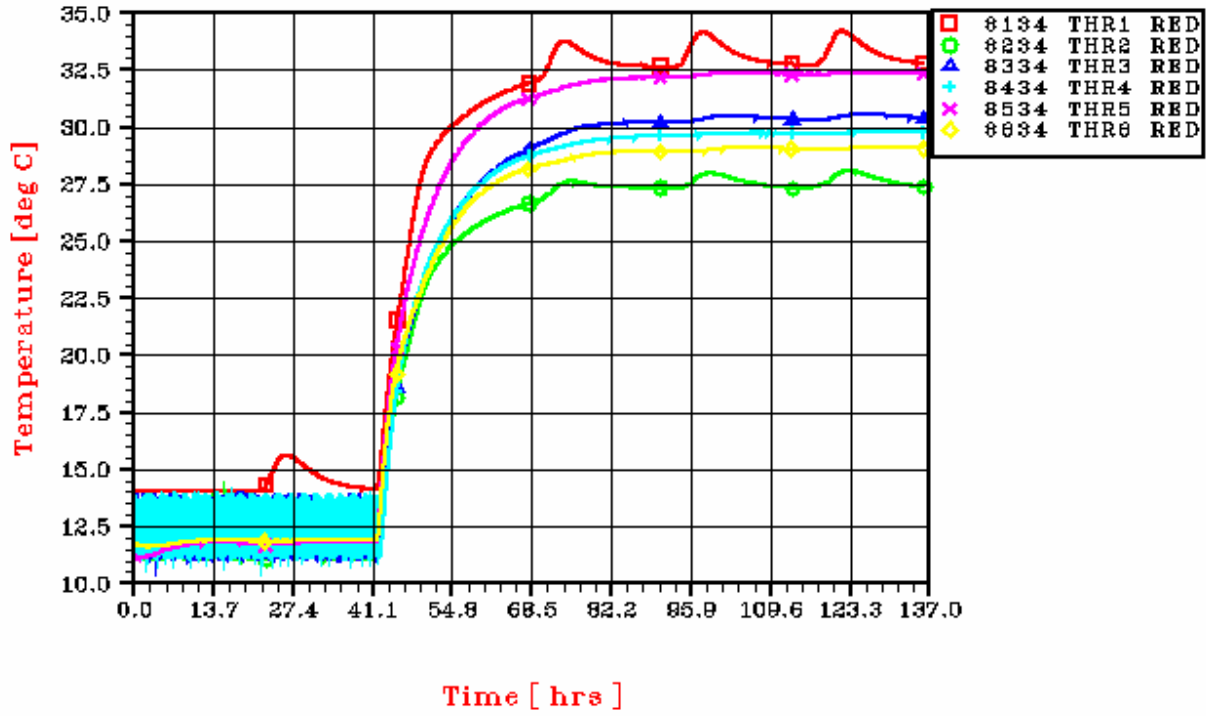

10.5 HERSCHEL RESULTS OF CASE Q

**HERSCHEL TRANSIENT CASE Q EOL**

**PANEL +Y+Z**

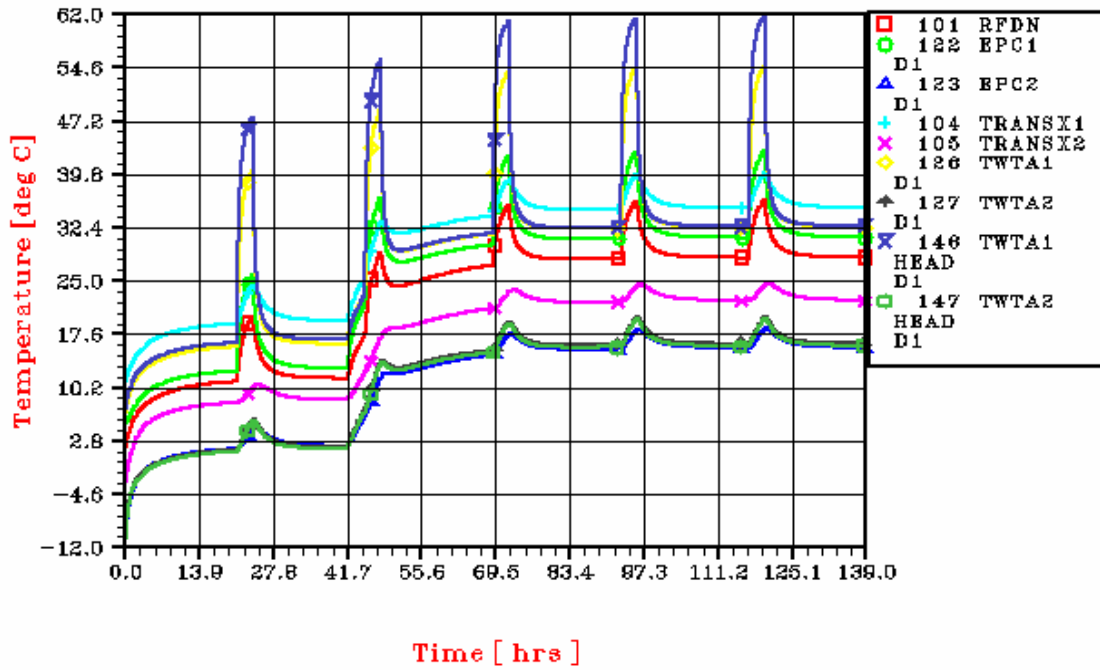

**HERSCHEL TRANSIENT CASE Q EOL**  
**INTERNAL UNITS**

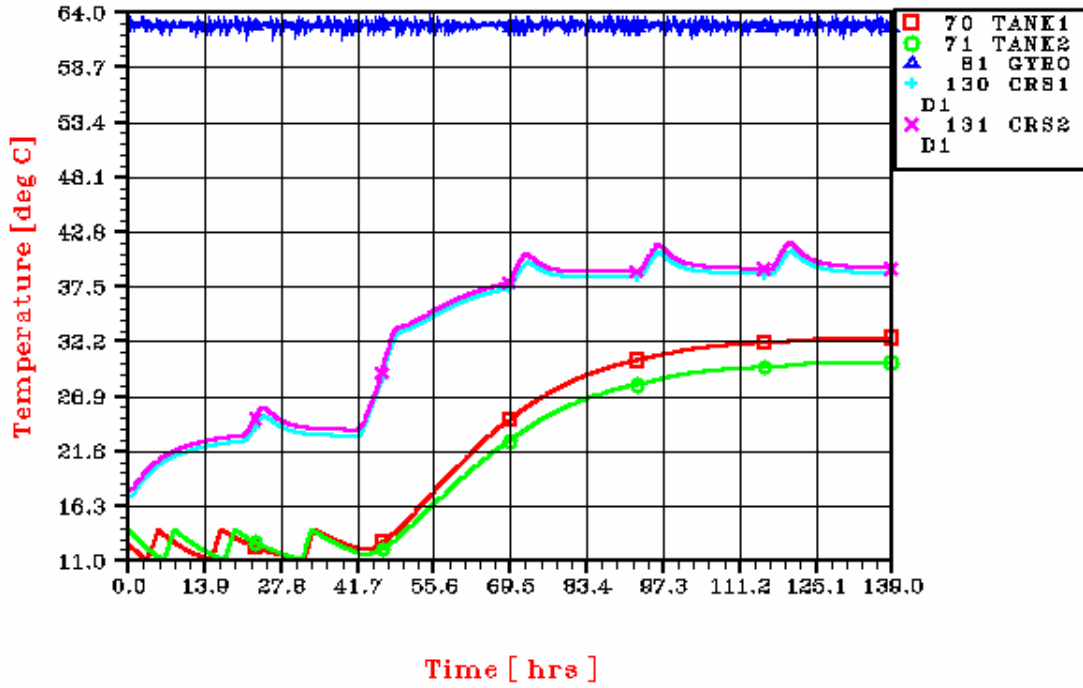

HERSCHEL TRANSIENT CASE Q EOL

PANEL +Y

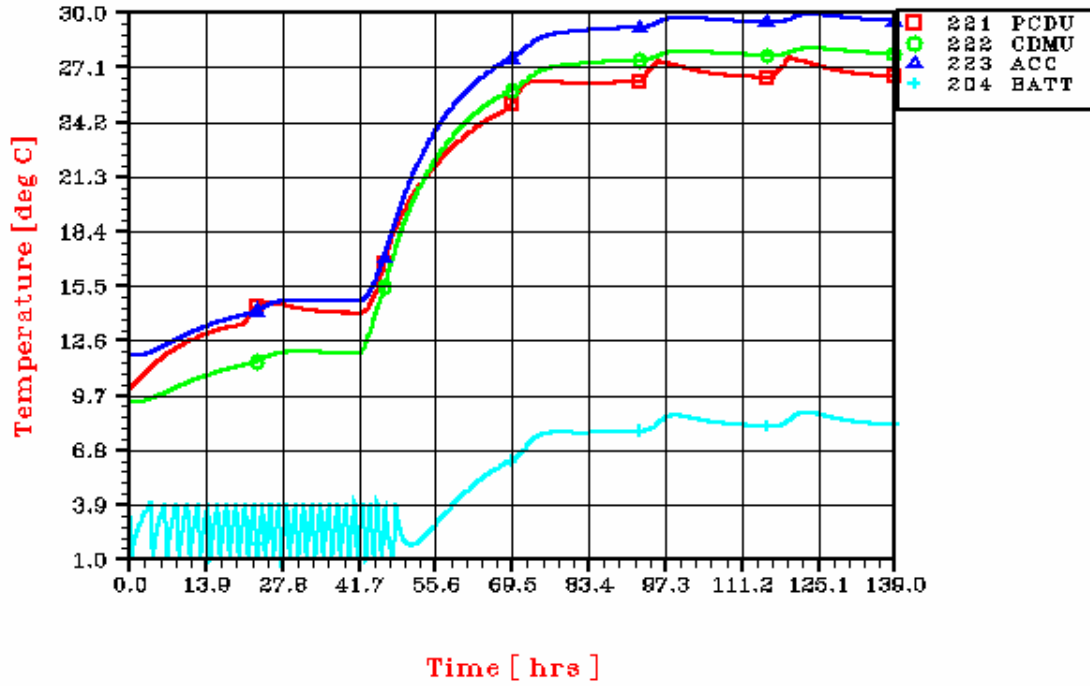

HERSCHEL TRANSIENT CASE Q EOL  
PANEL +Y-Z

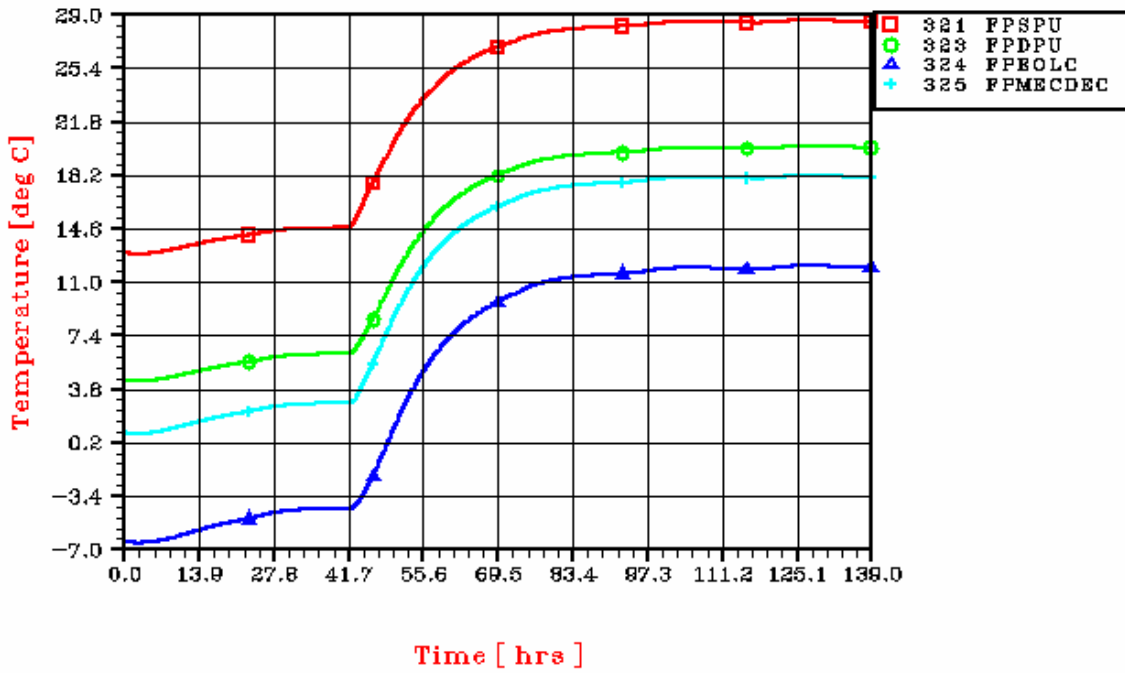

HERSCHEL TRANSIENT CASE Q EOL  
PANEL -Z

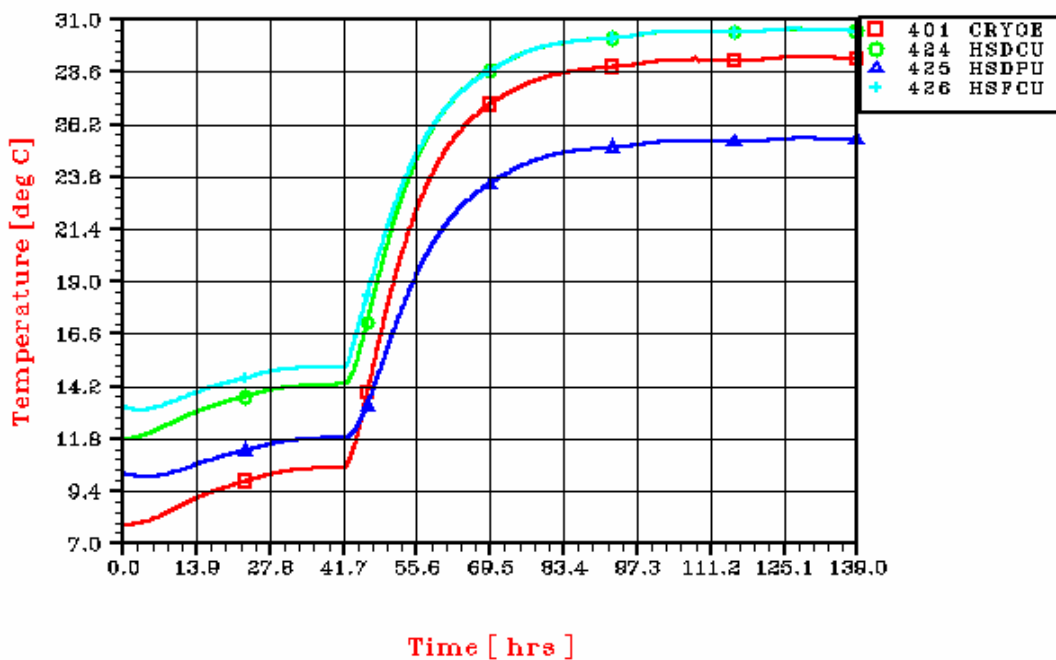

HERSCHEL TRANSIENT CASE Q EOL

PANEL -Y-Z

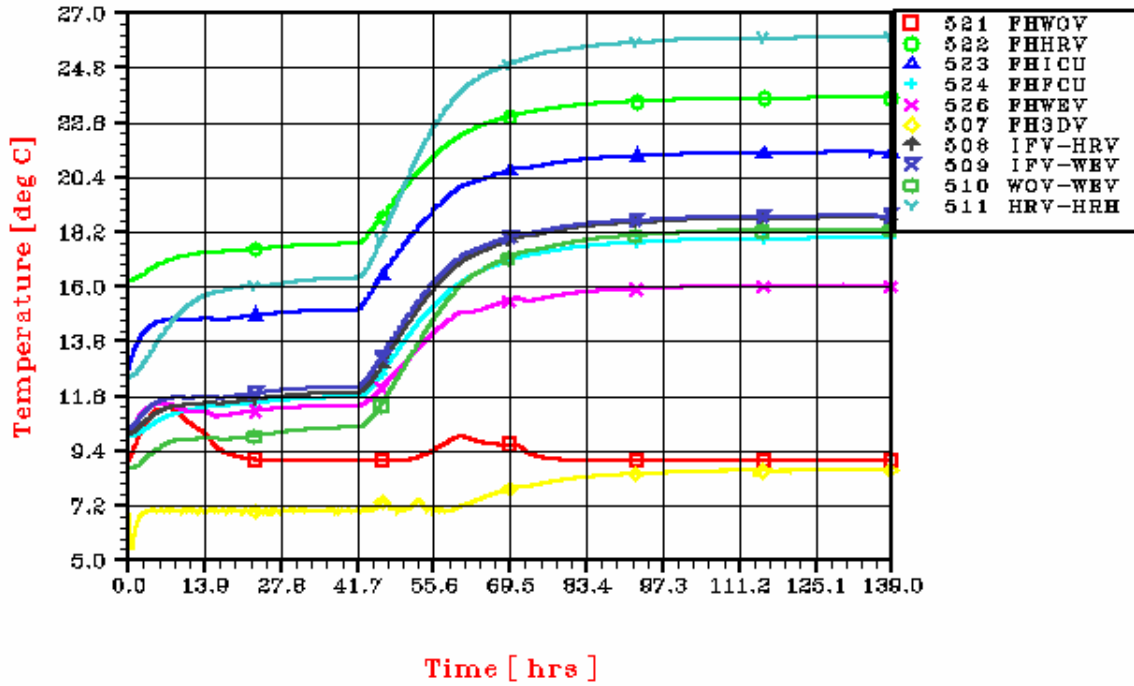

HERSCHEL TRANSIENT CASE Q EOL

PANEL -Y

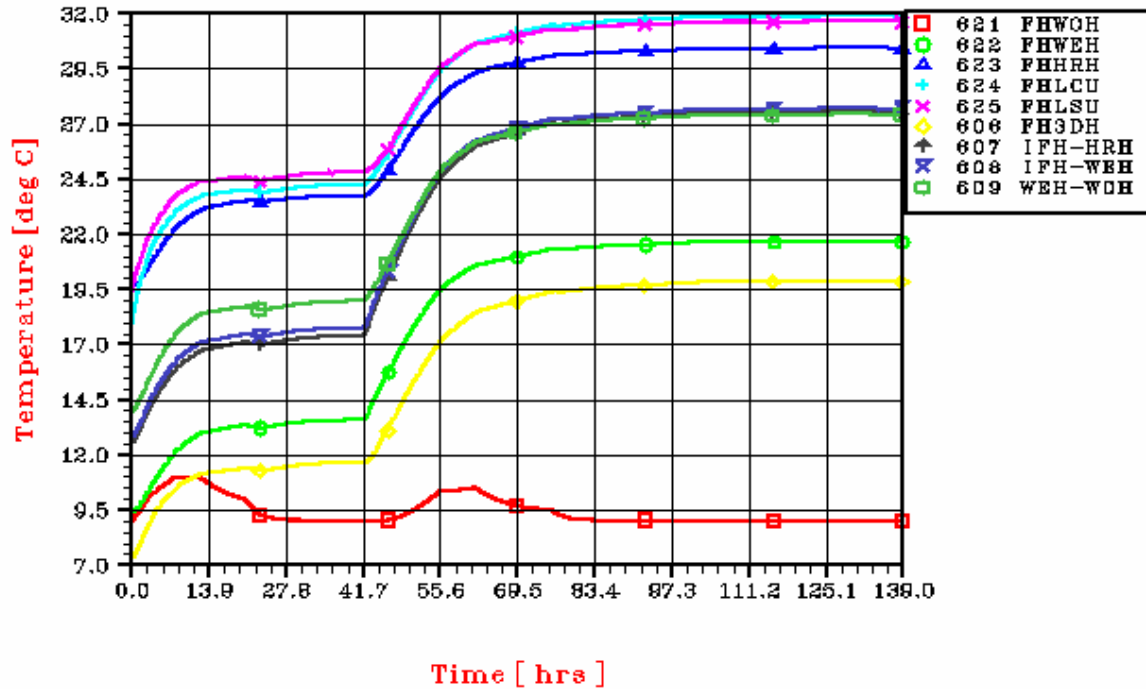

HERSCHEL TRANSIENT CASE Q EOL  
PANEL -Y+Z

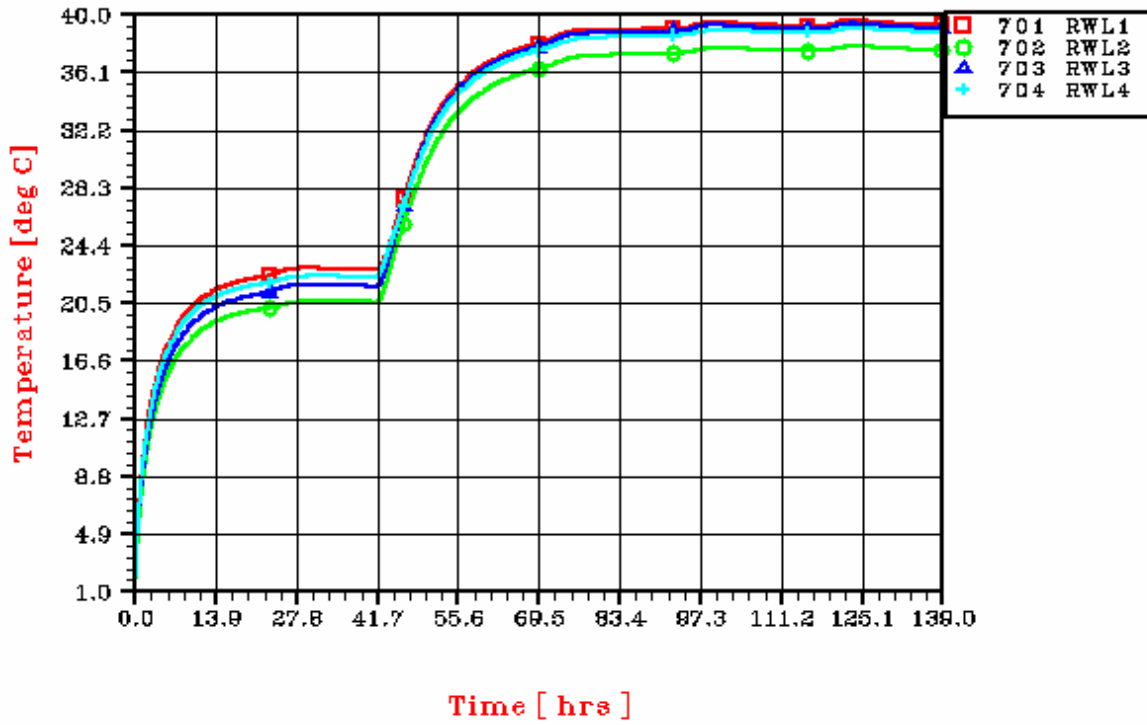



**HERSCHEL TRANSIENT CASE Q EOL**  
**EXTERNAL UNITS**

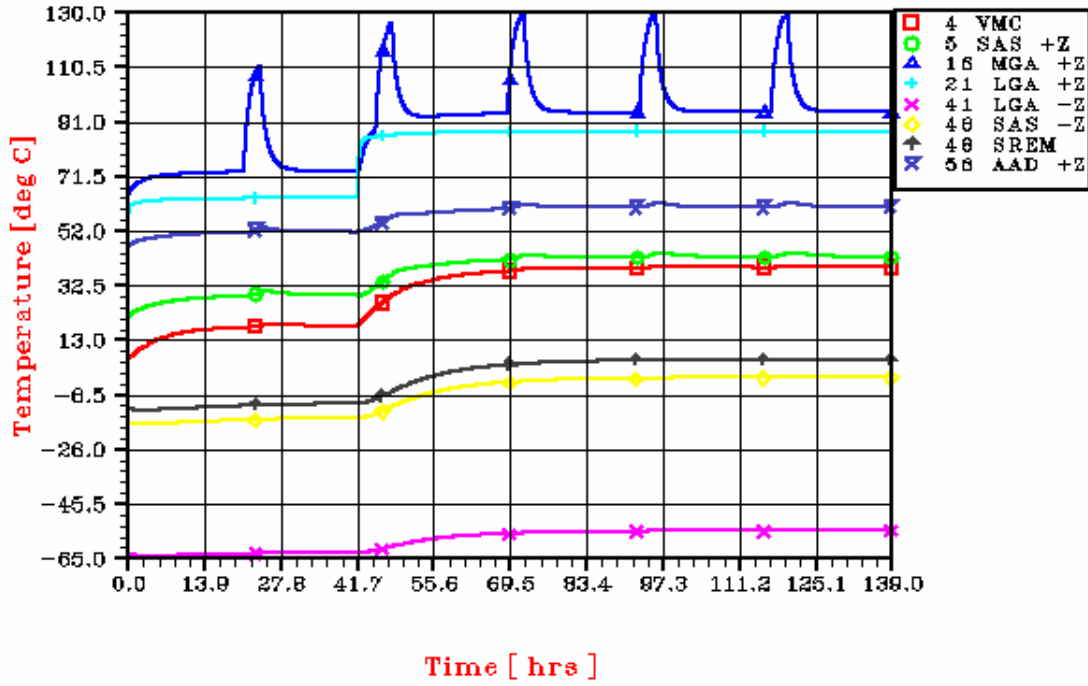

**HERSCHEL TRANSIENT CASE Q EOL**  
**STR BASEPLATE**

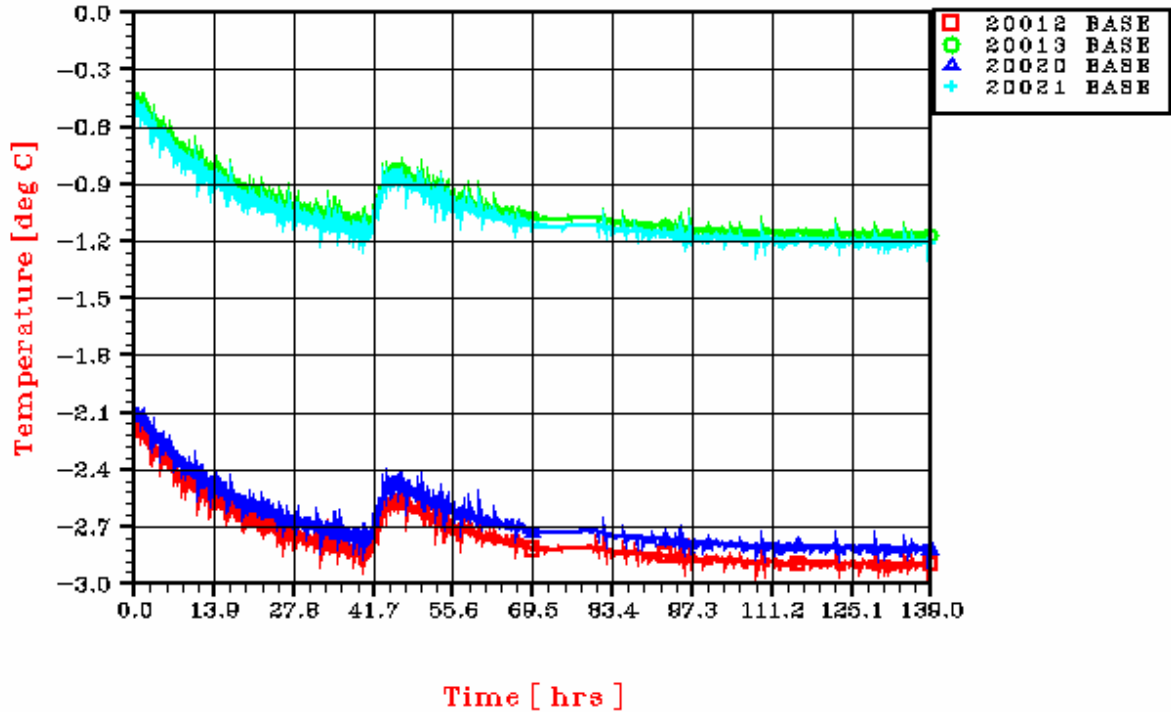

**HERSCHEL TRANSIENT CASE Q EOL**  
**THRUSTERS MAIN**

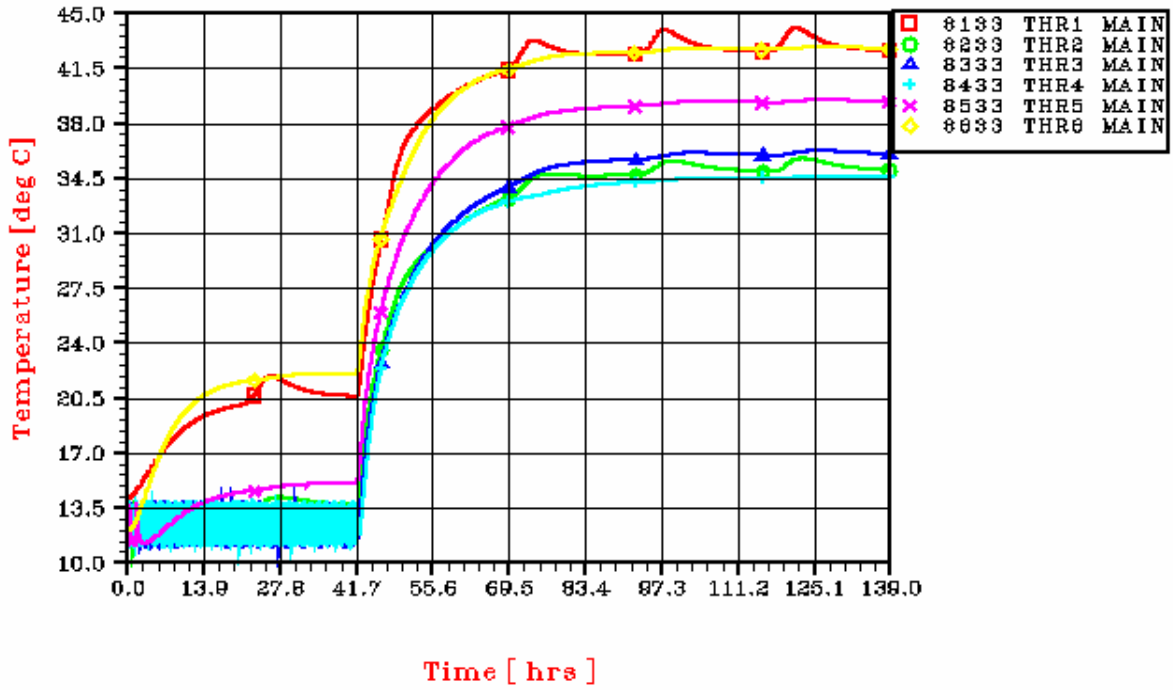

**HERSCHEL TRANSIENT CASE Q EOL**  
**THRUSTERS REDUNDANT**

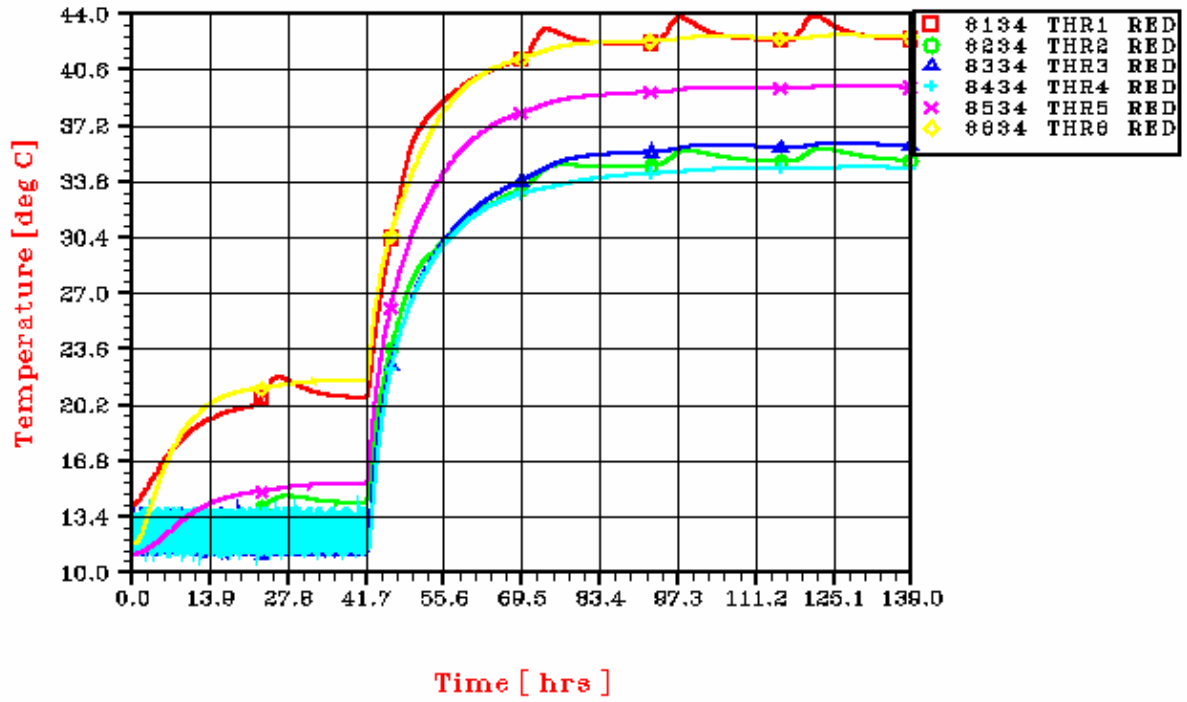



**Alcatel Alenia Space Italia S.p.A.**

**DOC. No : H-P-RP-AI-0040**  
**ISSUE : 05**  
**DATE : 24/FEB/06**  
**PAGE : 237 of 341**  
**CLASS. : DC**  
**ANNEXES : ..... Pages....**

## **11 PLANCK: TEMPERATURE PLOTS**

### **11.1 PLANCK: PLOTS OF TRANSIENT NOMINAL ANALYSIS CASE A3**

In the following figures, the temperature plots of the transient nominal analysis concerning the satellite in BOLcondition and in configuration Mode 3 (Case A3).

PLANCK – CASE A3 BOL Mode3  
 LATERAL PANEL +Z

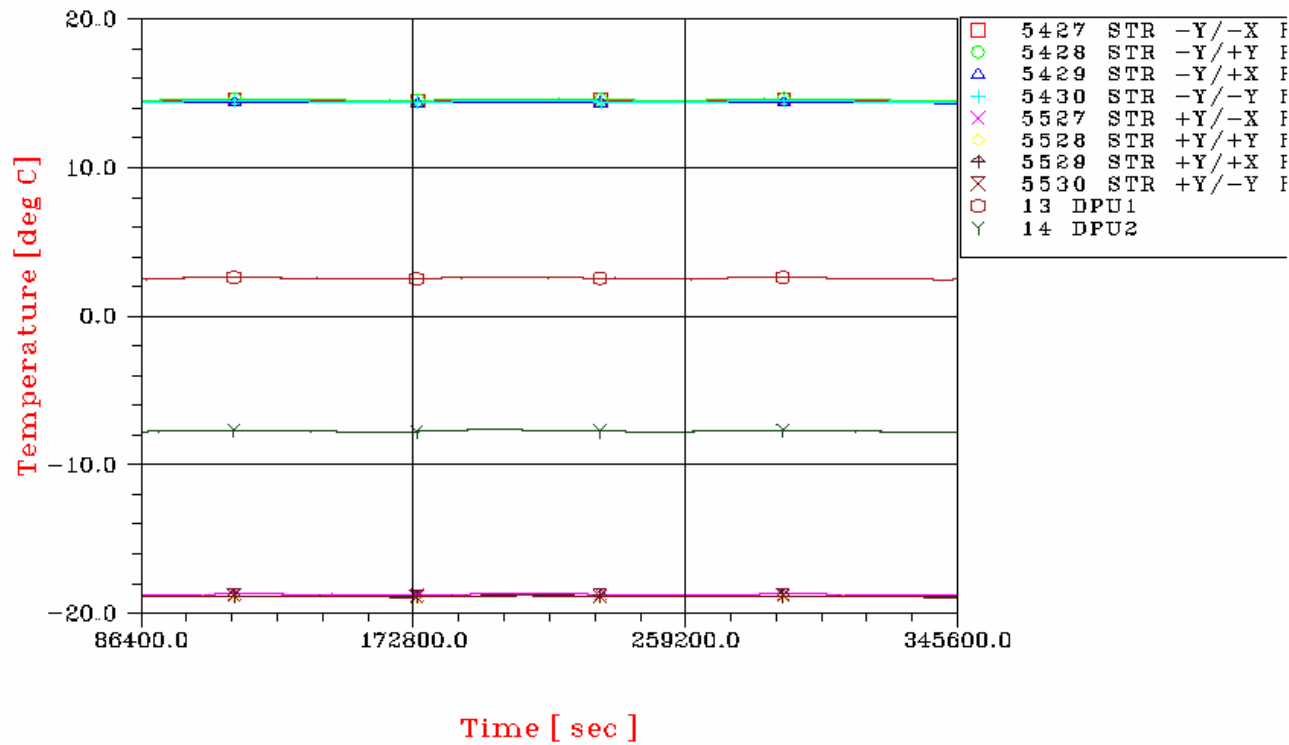

Figures 8.1-1 PLANCK - BOL Case A3 +Z panel

PLANCK – CASE A3 BOL Mode3

LATERAL PANEL +Z+Y

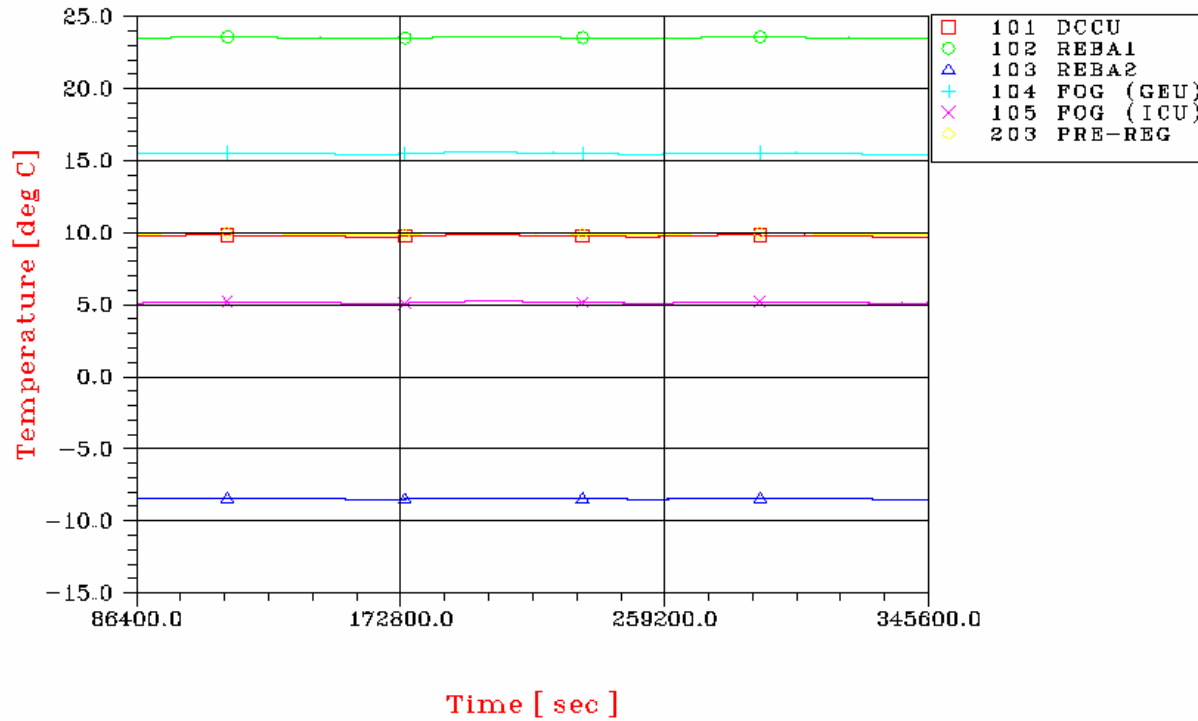

Figures 8.1-2 PLANCK - BOL CASE A3 +Y+Z panel

PLANCK – CASE A3 BOL Mode3

LATERAL PANEL +Y

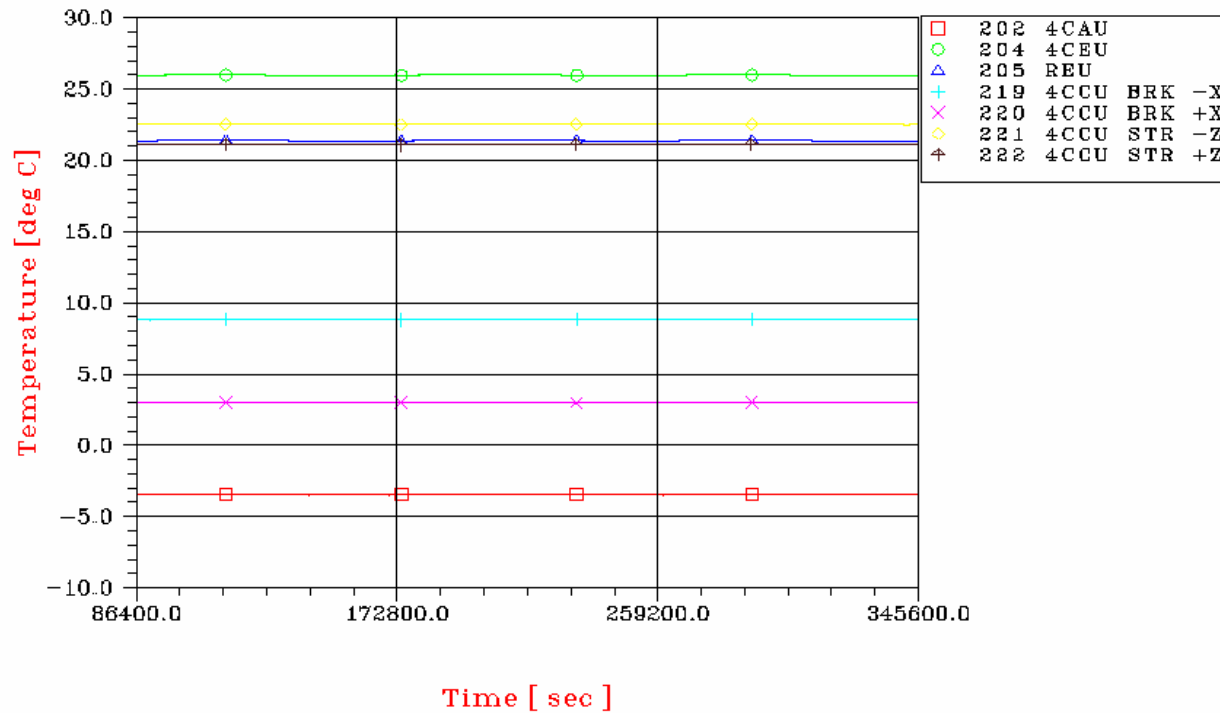

Figures 8.1-3 PLANCK - BOL CASE A3 +Y panel



PLANCK – CASE A3 BOL Mode3

SCC1 ON

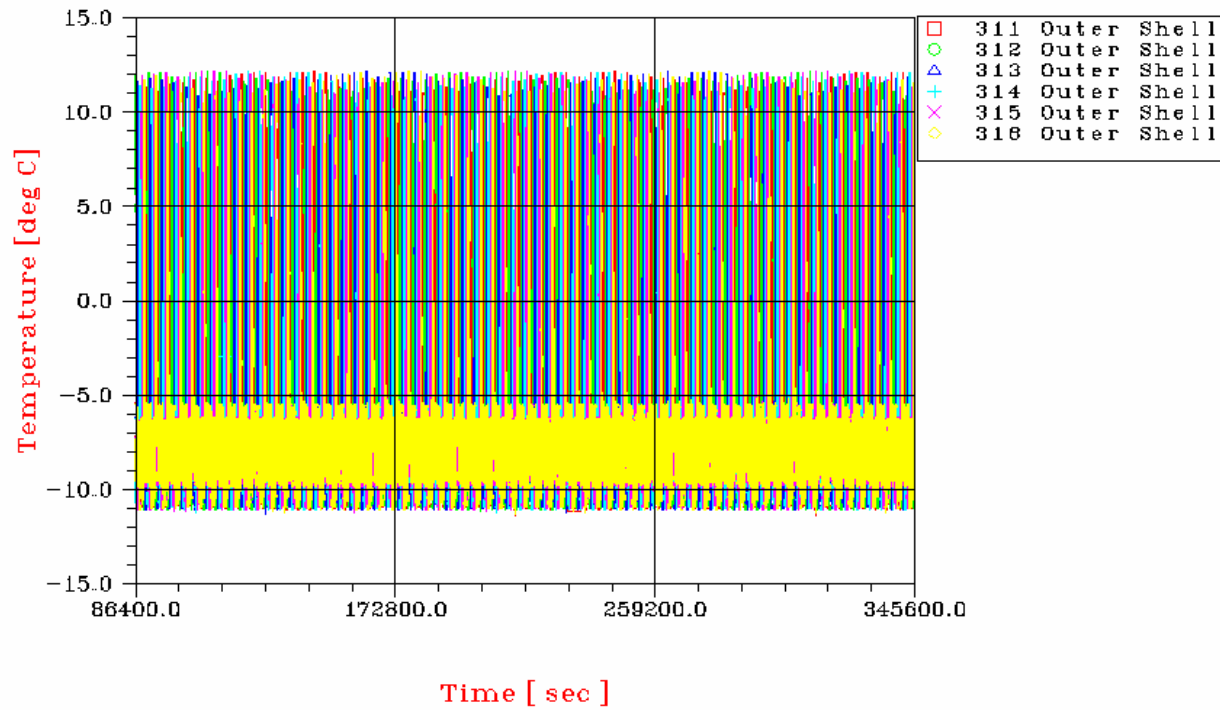

Figures 8.1-4 PLANCK - BOL CASE A3 +Y-Z panel

PLANCK – CASE A3 BOL Mode3

SCC1 ON

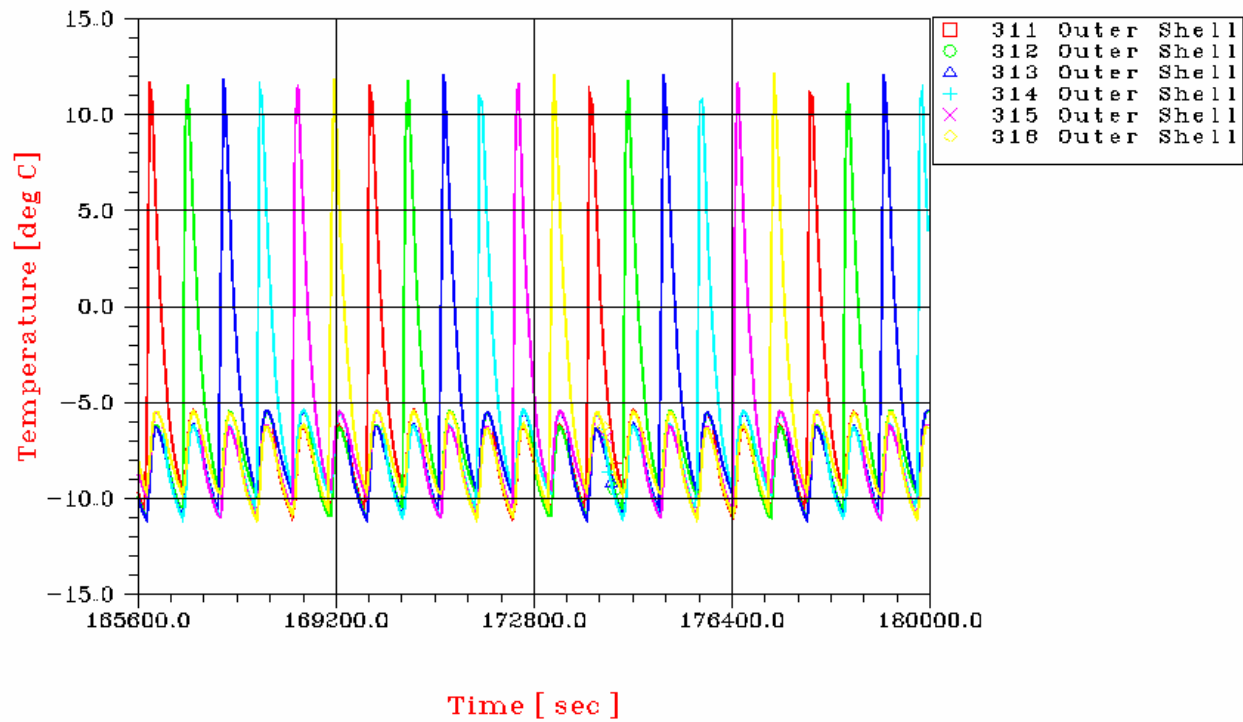

Figures 8.1-5 PLANCK - BOL CASE A3 +Y-Z panel

PLANCK – CASE A3 BOL Mode3

SCC1

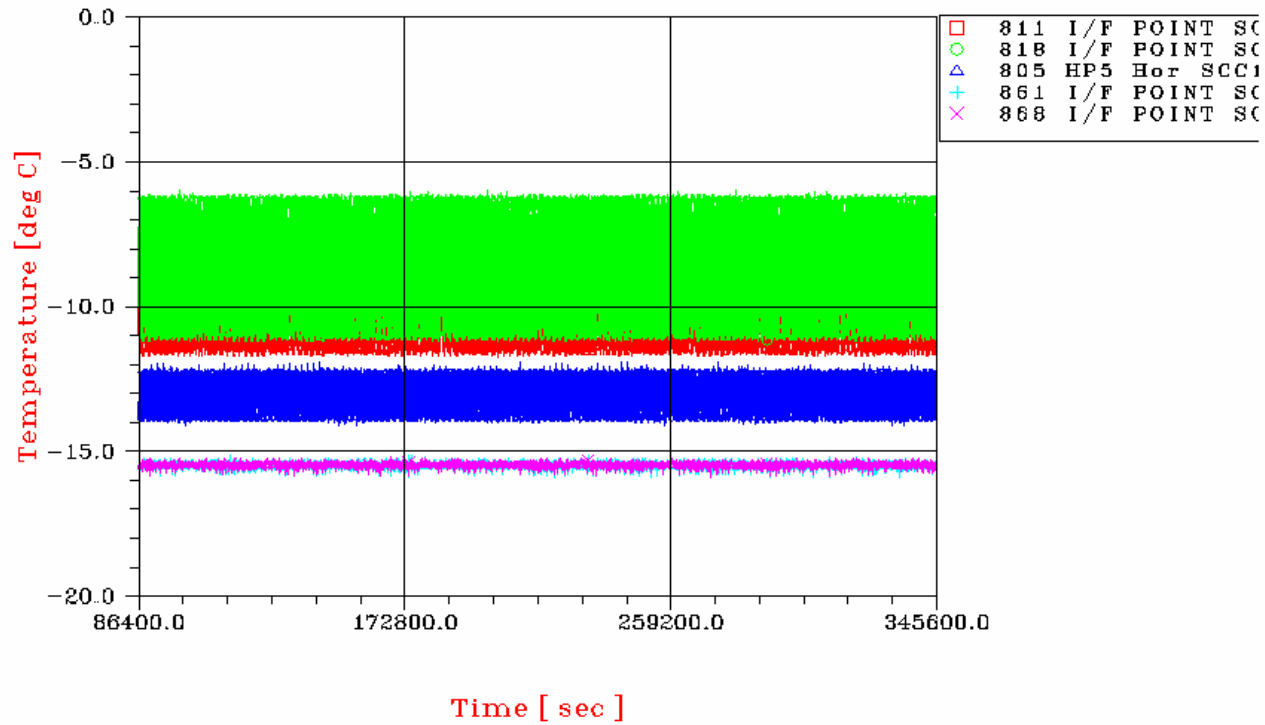

Figures 8.1-6 PLANCK - BOL CASE A3 SCC I/F temperatures

PLANCK – CASE A3 BOL Mode3

SCC1

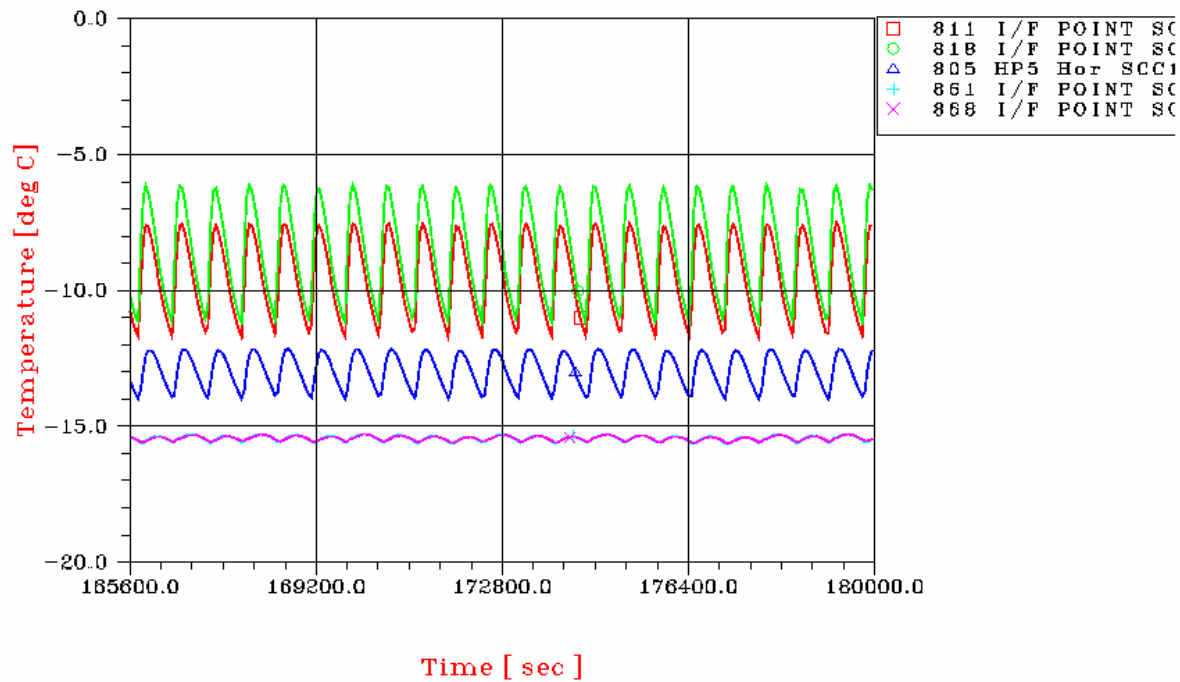

Figures 8.1-7 PLANCK - BOL CASE A3 SCC I/F temperatures

PLANCK - CASE A3 BOL Mode3  
LATERAL PANEL -Z

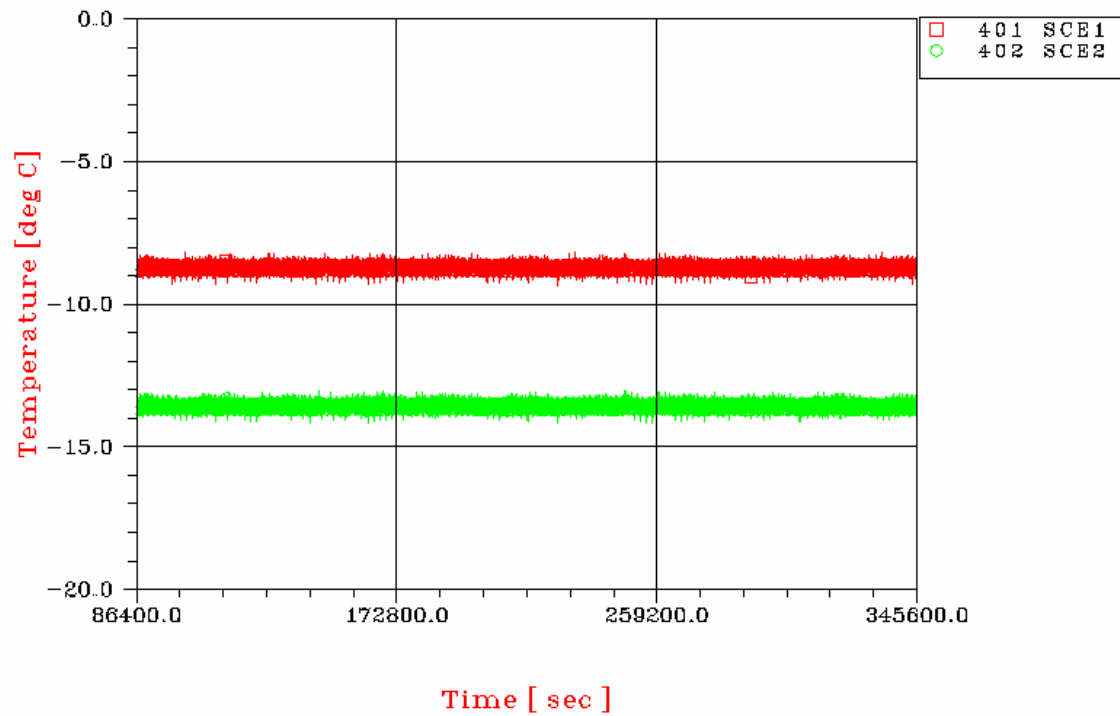

Figures 8.1-8 PLANCK - BOL CASE A3 -Z panel

PLANCK – CASE A3 BOL Mode3

SCC2 OFF

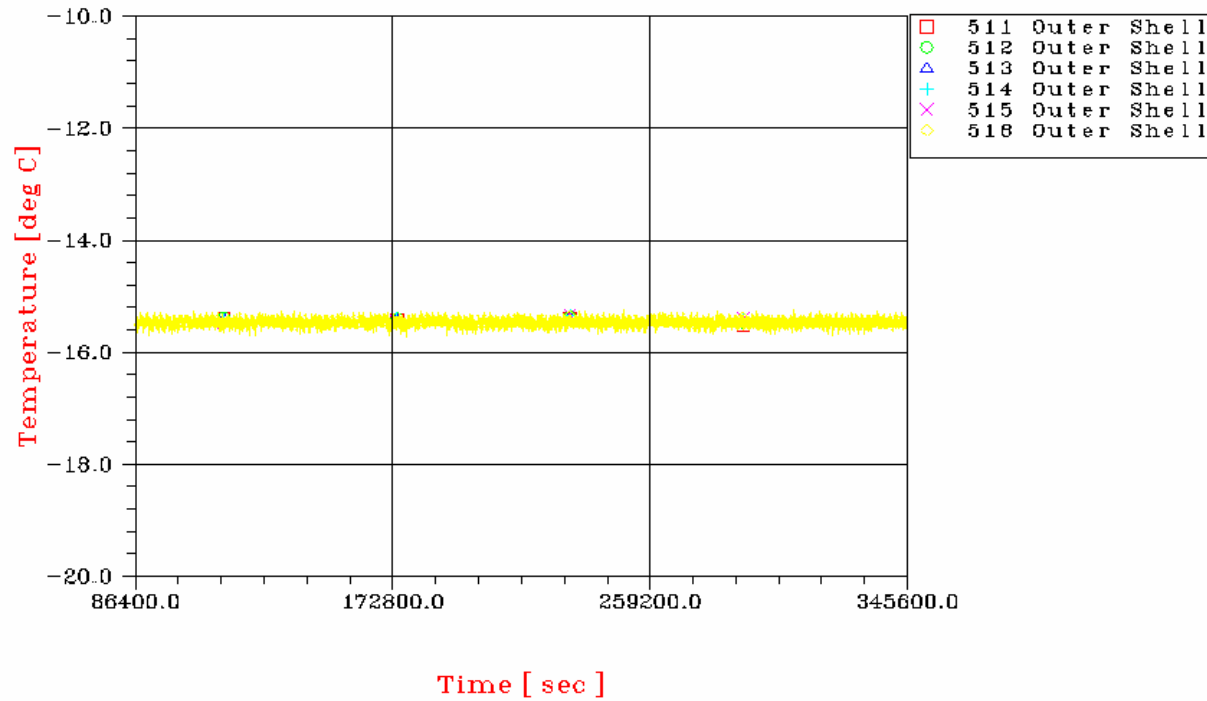

Figures 8.1-9 PLANCK - BOL CASE A3 –Y-Z panel

PLANCK - CASE A3 BOL Mode3  
LATERAL PANEL -Y

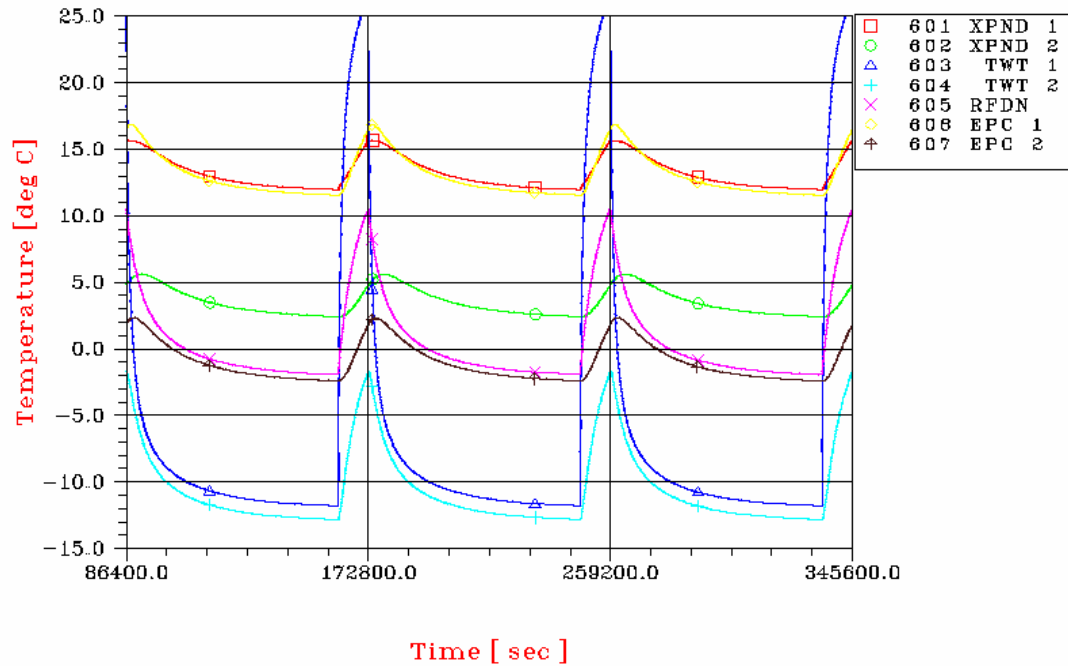

Figures 8.1-10 PLANCK - BOL CASE A3 -Y panel

PLANCK – CASE A3 BOL Mode3  
 LATERAL PANEL +Z-Y

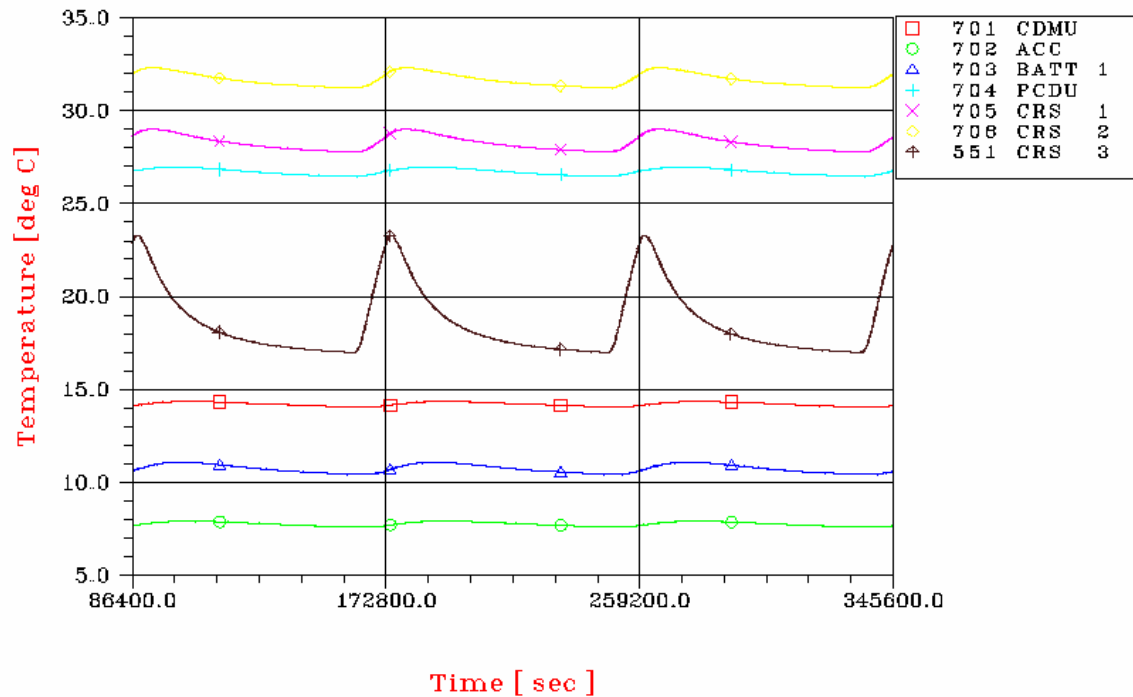

Figures 8.1-11 PLANCK - BOL CASE A3 -Y+Z panel



PLANCK - CASE A3 BOL Mode3  
SUBPLATFORM +X-X

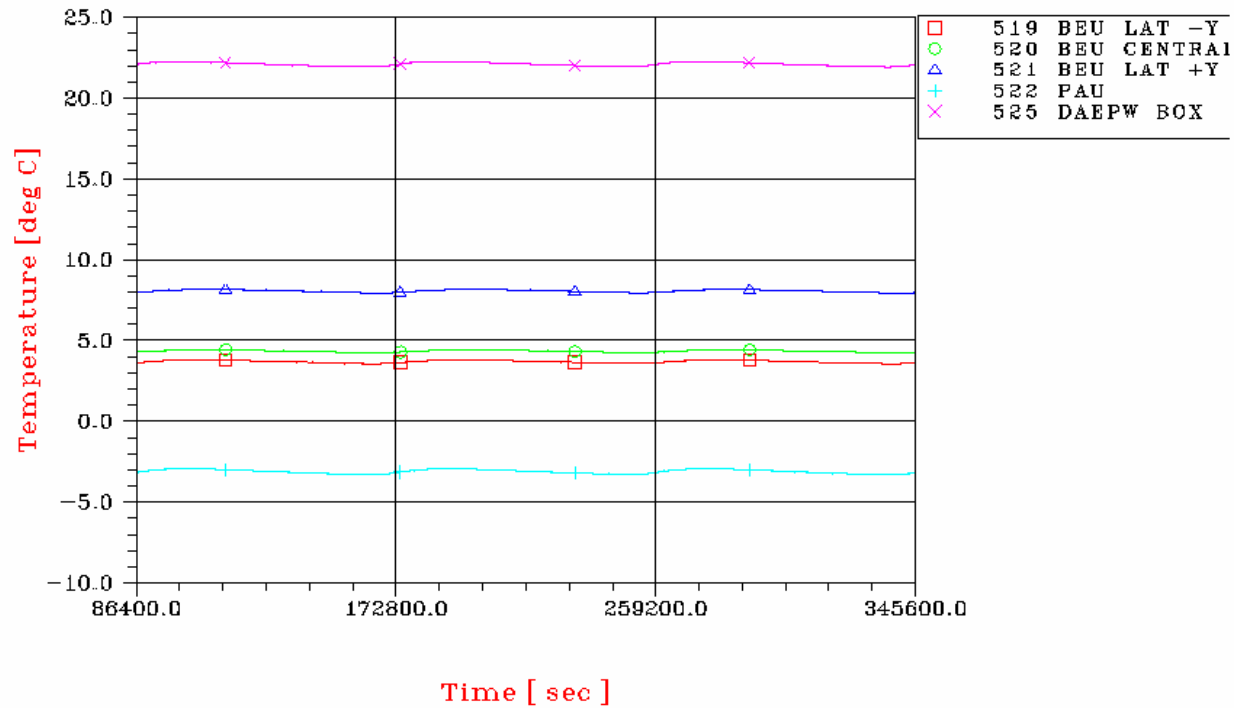

Figures 8.1-12 PLANCK - BOL CASE A3 subplatform panel

PLANCK – CASE A3 BOL Mode3

HE TANK

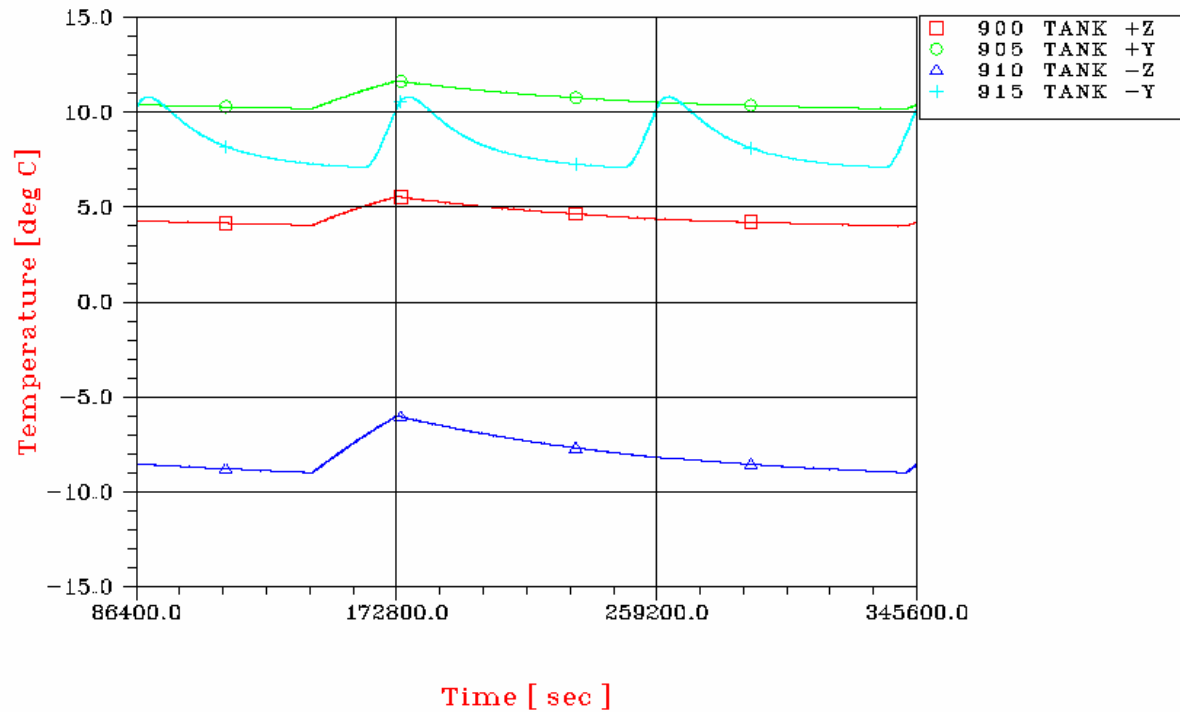

Figures 8.1-13 PLANCK - BOL CASE A3 Helium TANK

PLANCK – CASE A3 BOL Mode3  
PROPELLANT TANK

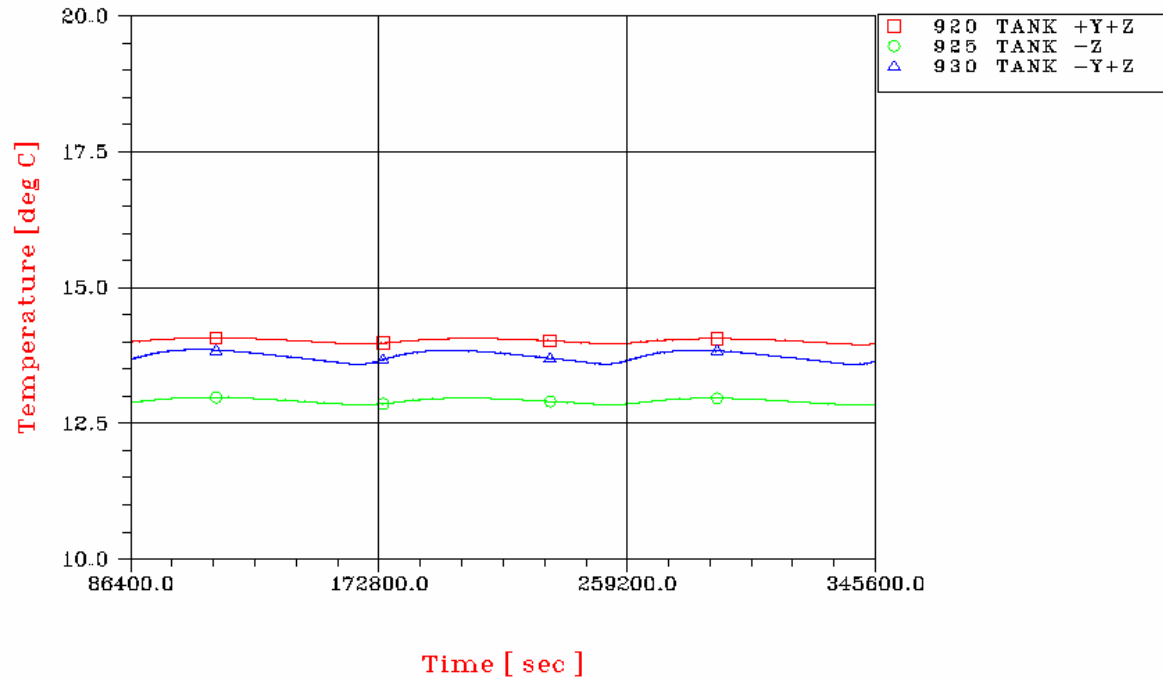

Figures 8.1-14 PLANCK - BOL CASE A3 Propellant TANK



**Alcatel Alenia Space Italia S.p.A.**

**DOC. No : H-P-RP-AI-0040**  
**ISSUE : 05**  
**DATE : 24/FEB/06**  
**PAGE : 252 of 341**  
**CLASS. : DC**  
**ANNEXES : ..... Pages....**

## 11.2 PLANCK: PLOTS OF TRANSIENT NOMINAL ANALYSIS CASE B2

In the following figures, the temperature plots of the transient analysis concerning the satellite in EOL condition and with the SCC2 operating are presented.

PLANCK - CASE B2 EOL SCC2on  
 LATERAL PANEL +Z

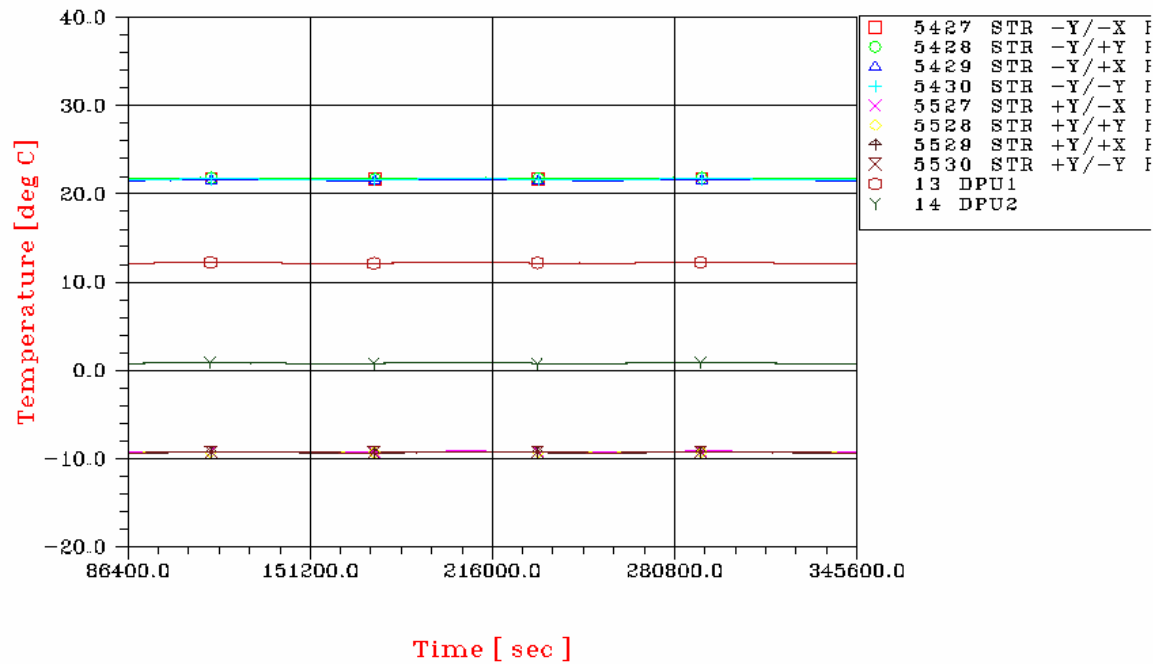

Figures 8.2-1 PLANCK - EOL CASE B2 +Z panel

PLANCK – CASE B2 EOL SCC2on

LATERAL PANEL +Z+Y

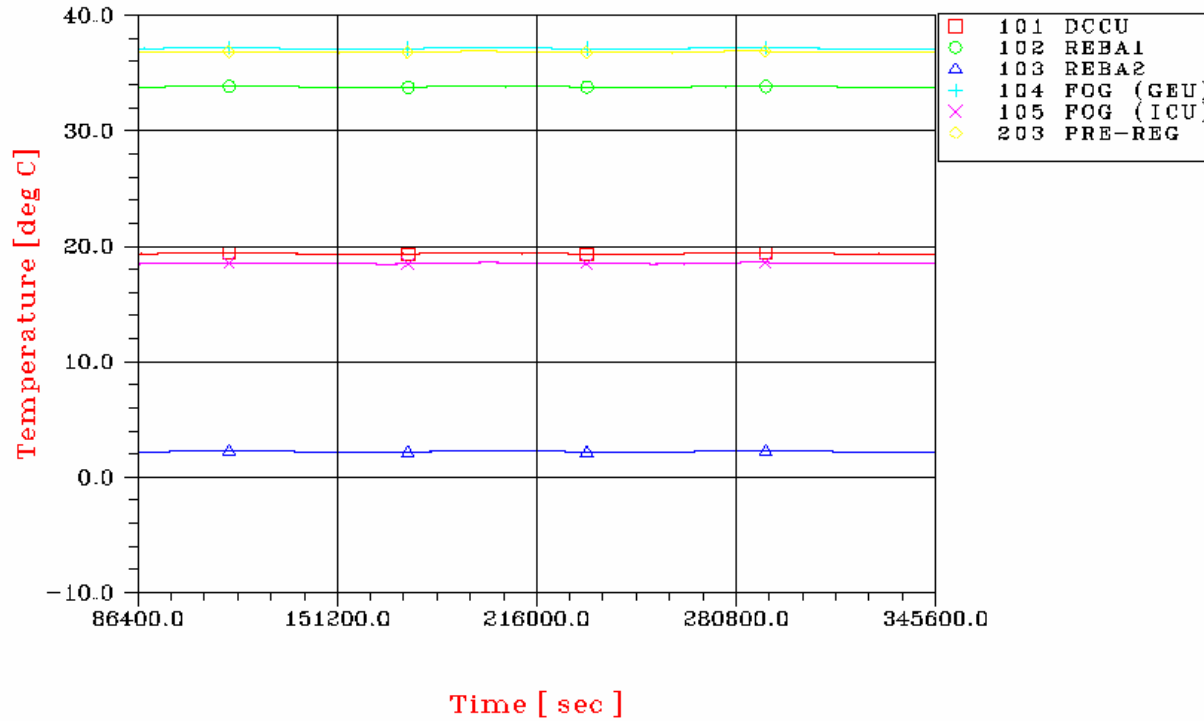

Figures 8.2-2 PLANCK - EOL CASE B2 +Y+Z panel

PLANCK - CASE B2 EOL SCC2on

LATERAL PANEL +Y

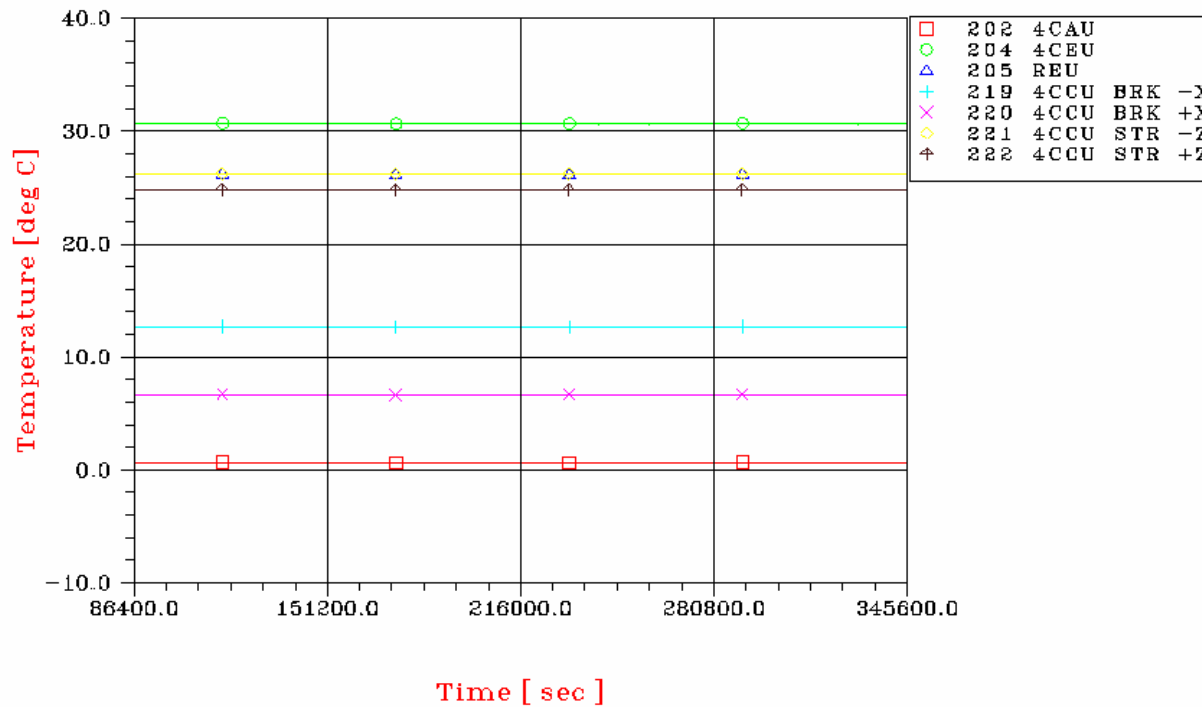

Figures 8.2-3 PLANCK - EOL CASE B2 +Y panel

PLANCK – CASE B2 EOL SCC2on  
SCC1

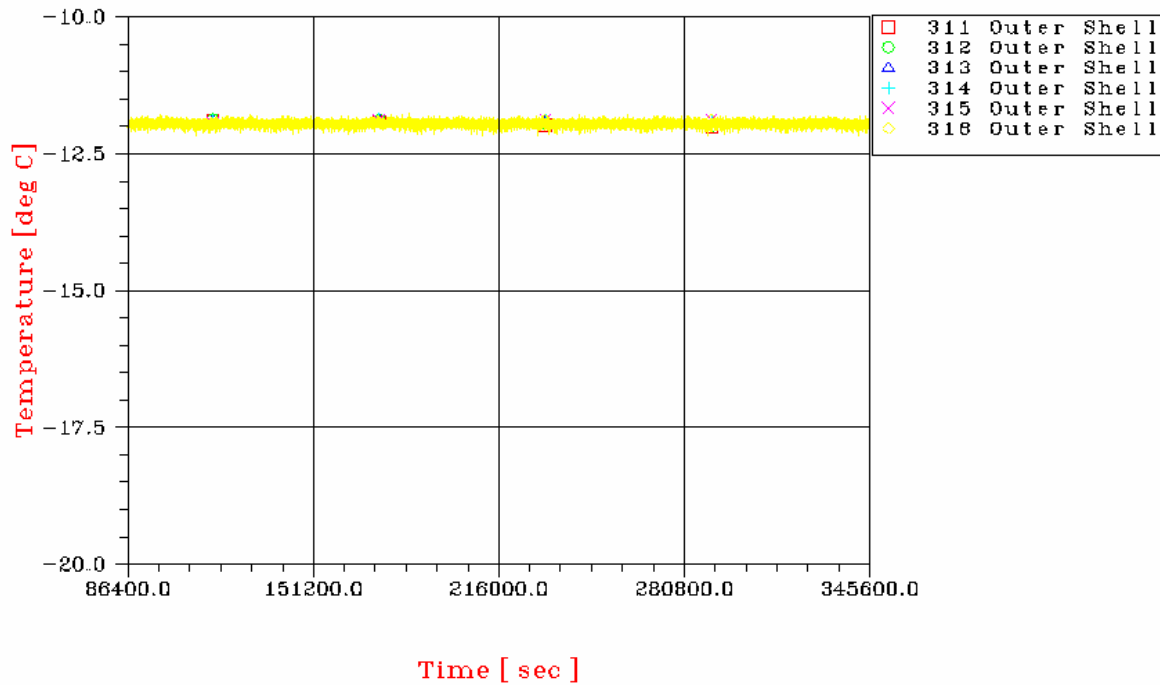

Figures 8.2-4 PLANCK - EOL CASE B2 +Y-Z panel



PLANCK – CASE B2 EOL SCC2on  
SCC I/F

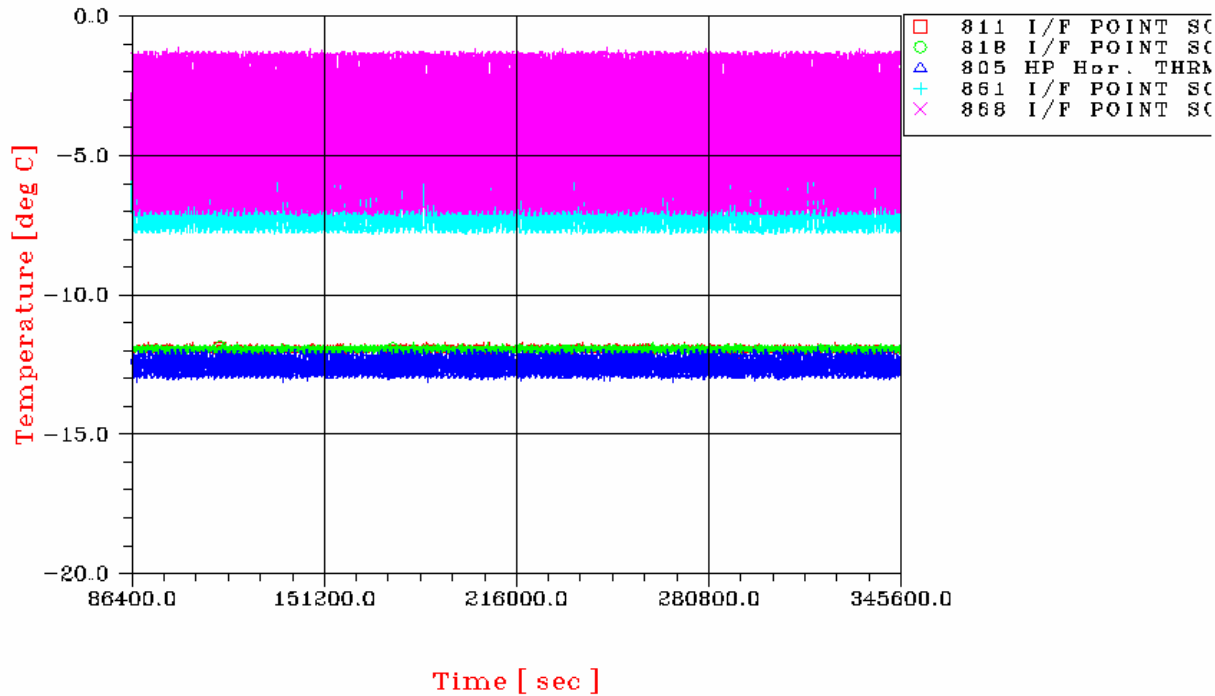

Figures 8.2-5 PLANCK - EOL CASE B2 SCC I/F temperatures

PLANCK – CASE B2 EOL SCC2on

SCC I/F

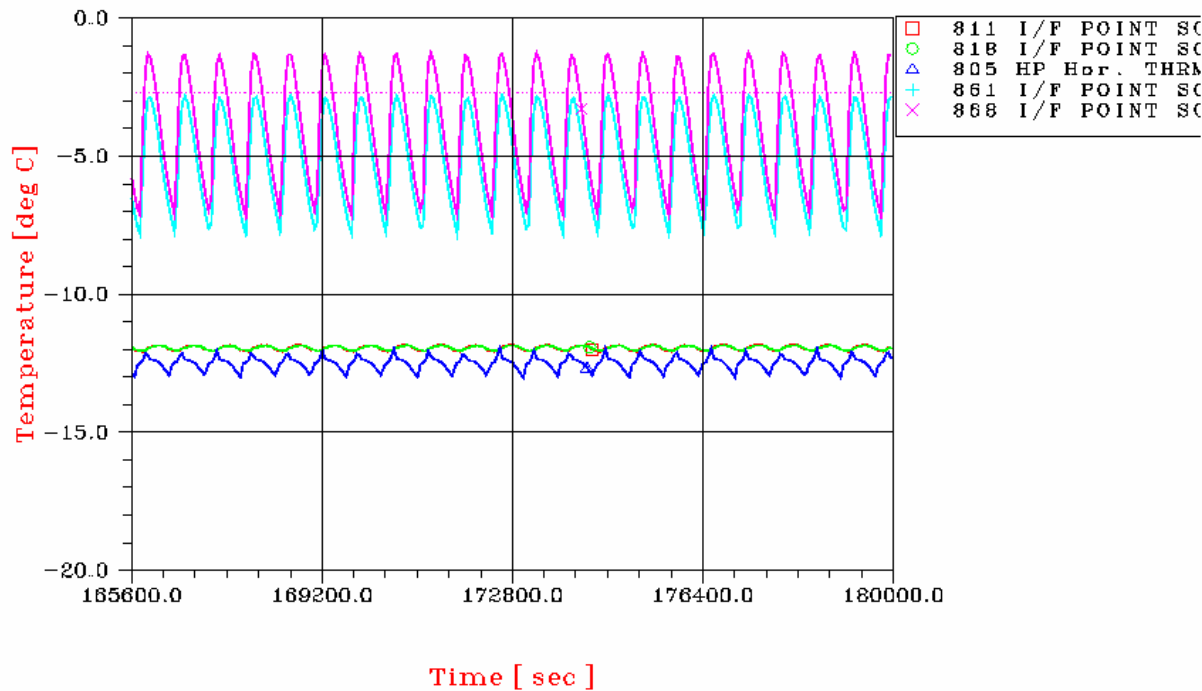

Figures 8.2-6 PLANCK - EOL CASE B2 SCC I/F temperatures

PLANCK – CASE B2 EOL SCC2on  
LATERAL PANEL –Z

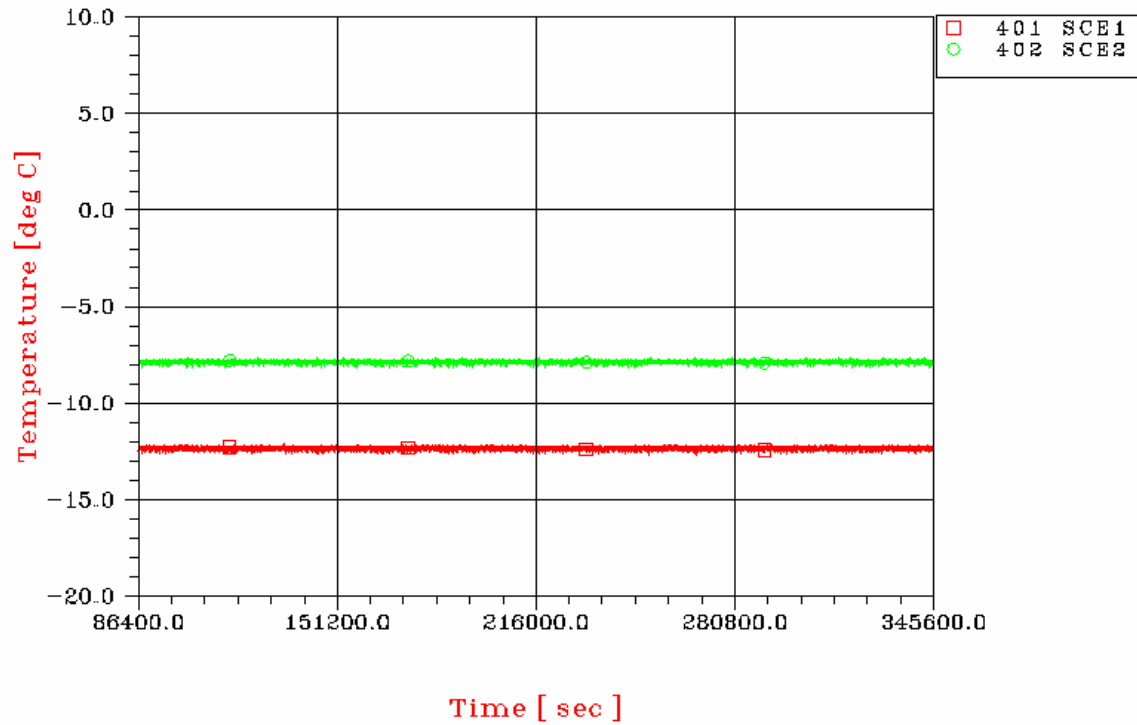

Figures 8.2-7 PLANCK - EOL CASE B2 -Z panel

PLANCK – CASE B2 EOL SCC2on

SCC2

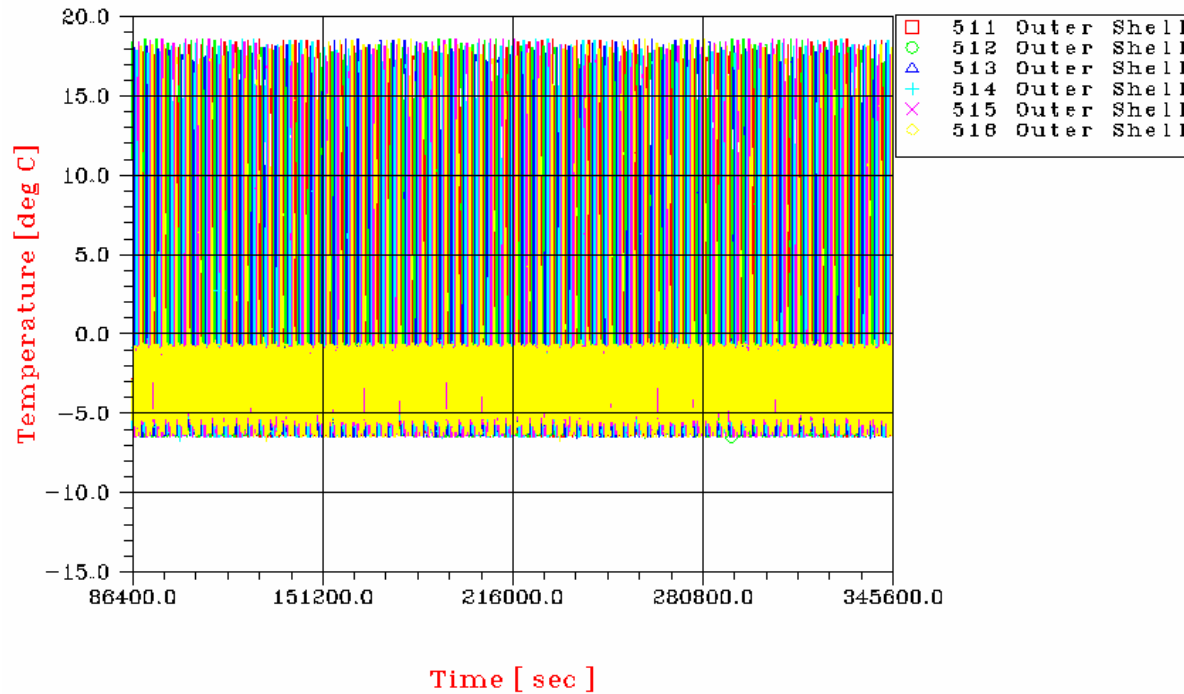

Figures 8.2-8 PLANCK - EOL CASE B2 –Y-Z panel

PLANCK – CASE B2 EOL SCC2on

SCC2

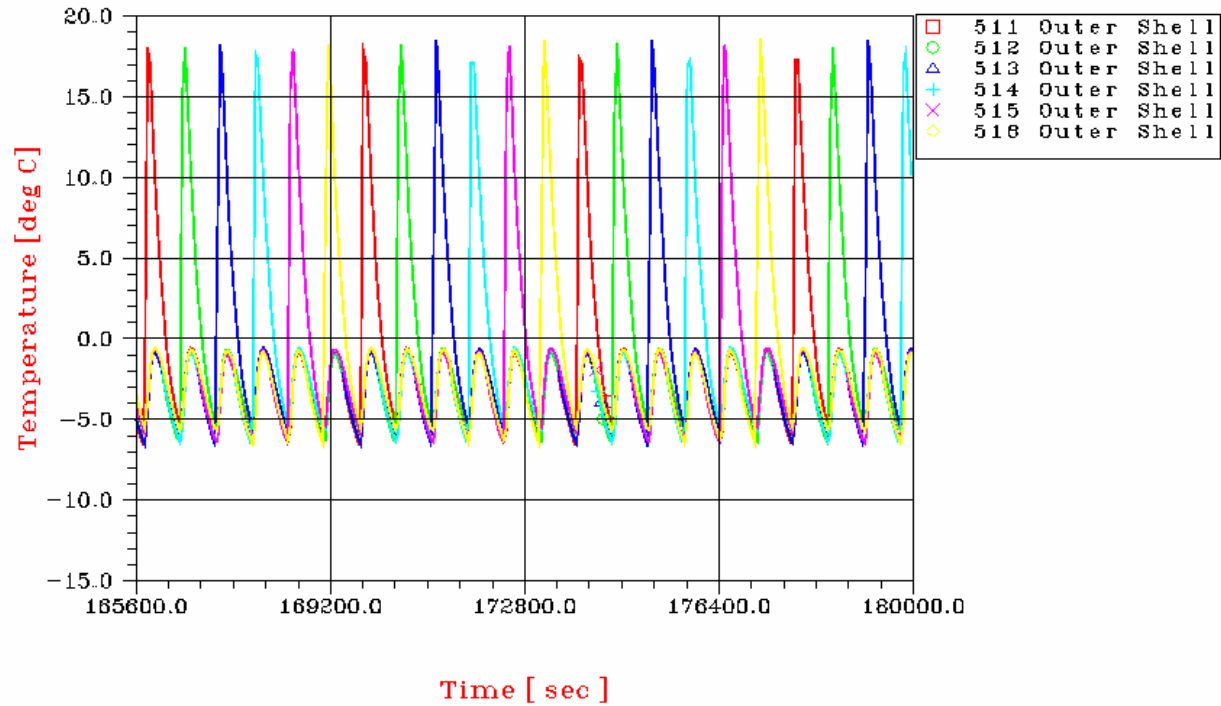

Figures 8.2-9 PLANCK - EOL CASE B2 –Y-Z panel

PLANCK - CASE B2 EOL SCC2on

LATERAL PANEL -Y

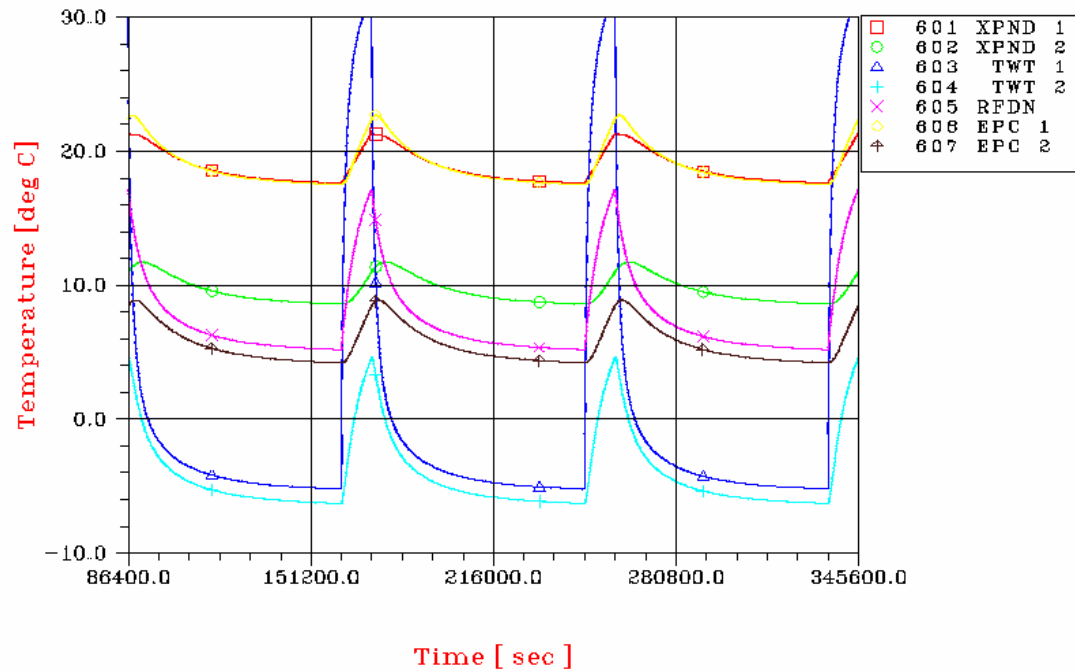

Figures 8.2-10 PLANCK - EOL CASE B2 -Y panel

PLANCK - CASE B2 EOL SCC2on

LATERAL PANEL +Z-Y

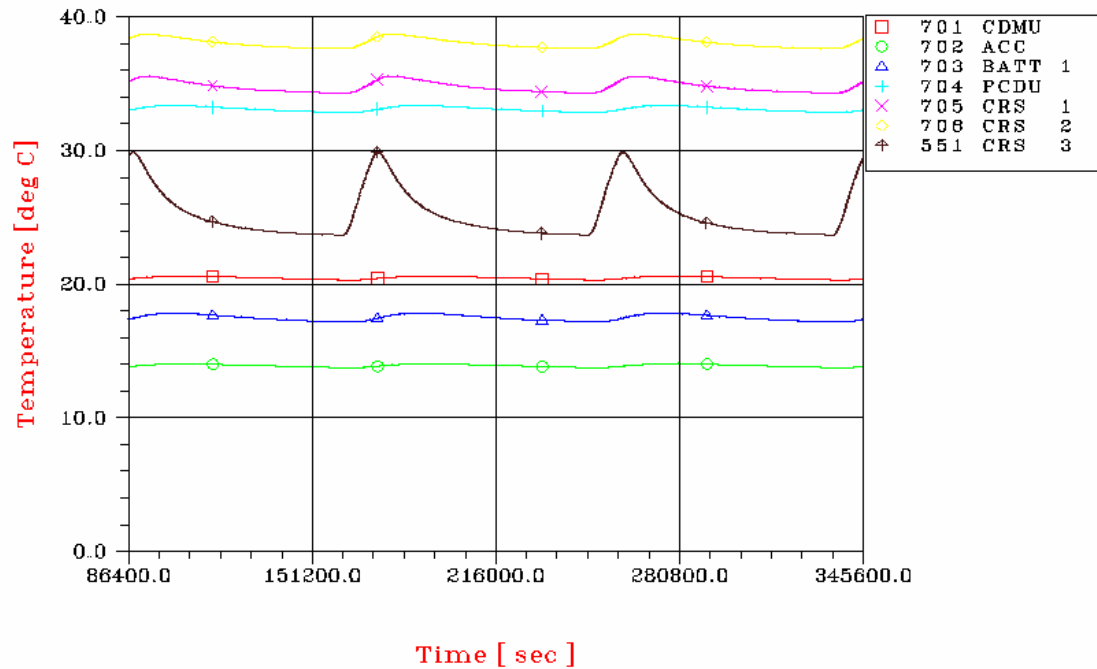

Figures 8.2-11 PLANCK - EOL CASE B2 -Y+Z panel

PLANCK - CASE B2 EOL SCC2on  
 SUBPLATFORM +X-X

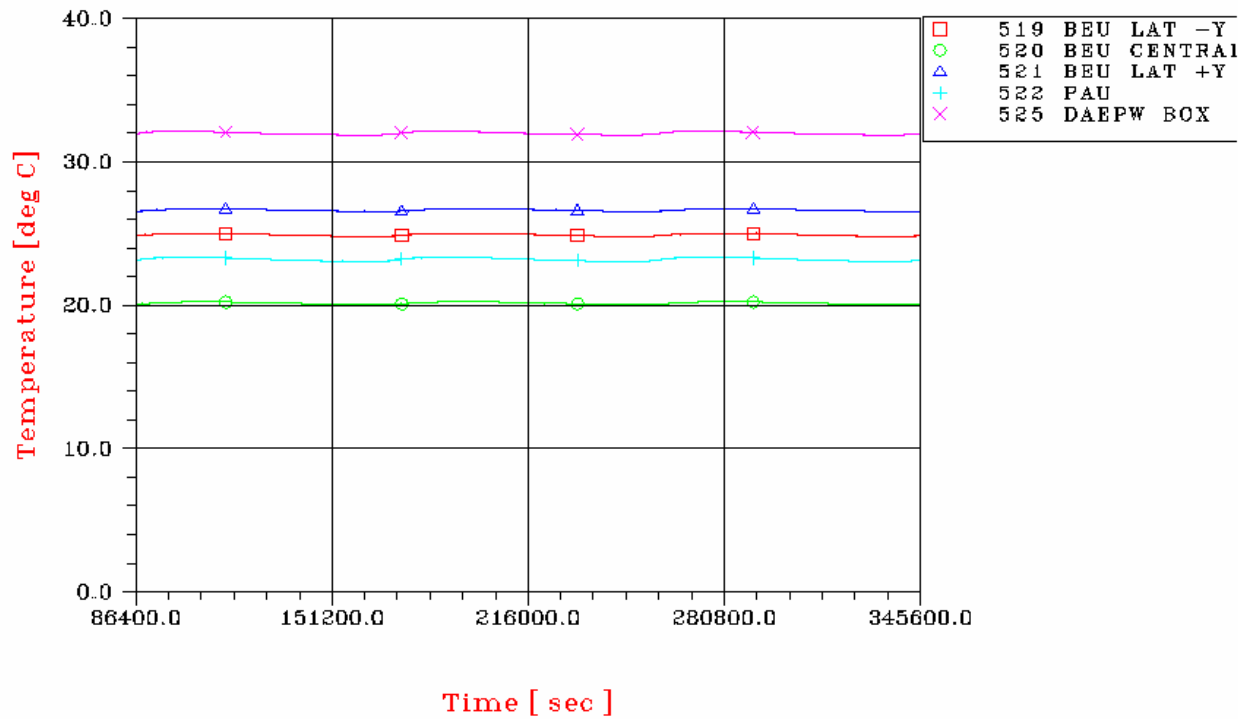

Figures 8.2-12 PLANCK - EOL CASE B2 subplatform panel



PLANCK - CASE B2 EOL SCC2on  
PROPELLANT TANK

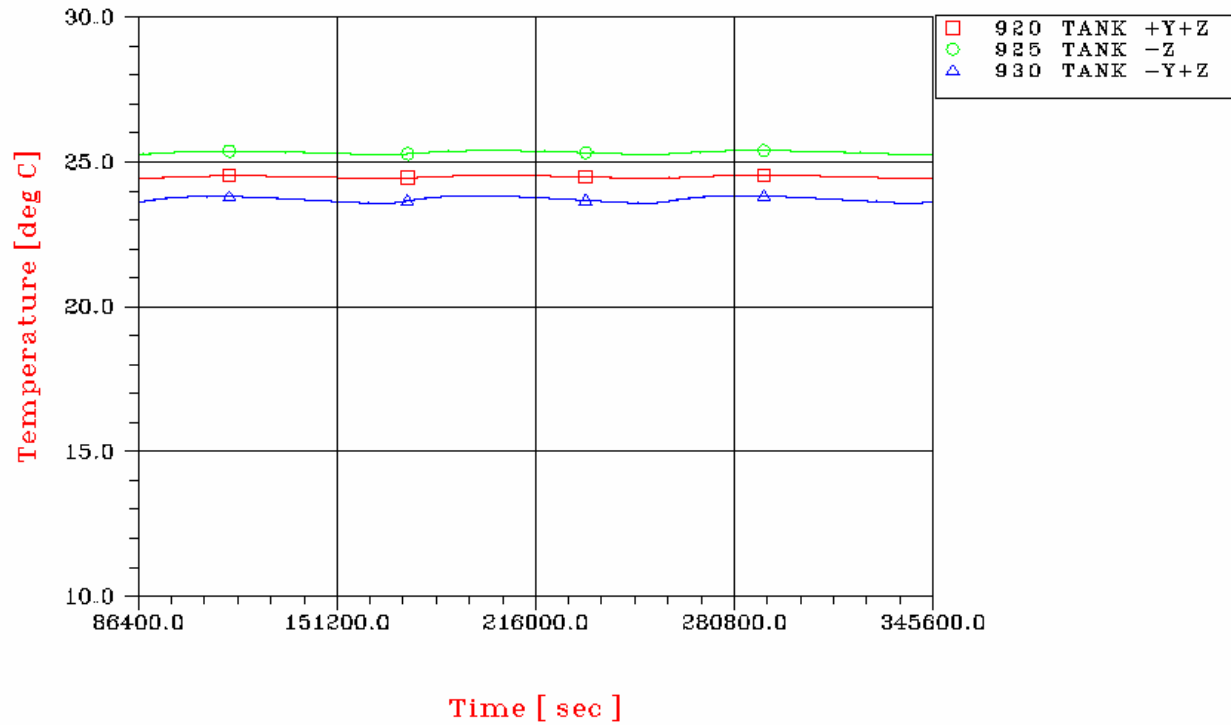

Figures 8.2-13 PLANCK - EOL CASE B2 propellant Tank

PLANCK – CASE B2 EOL SCC2on  
 HE TANK

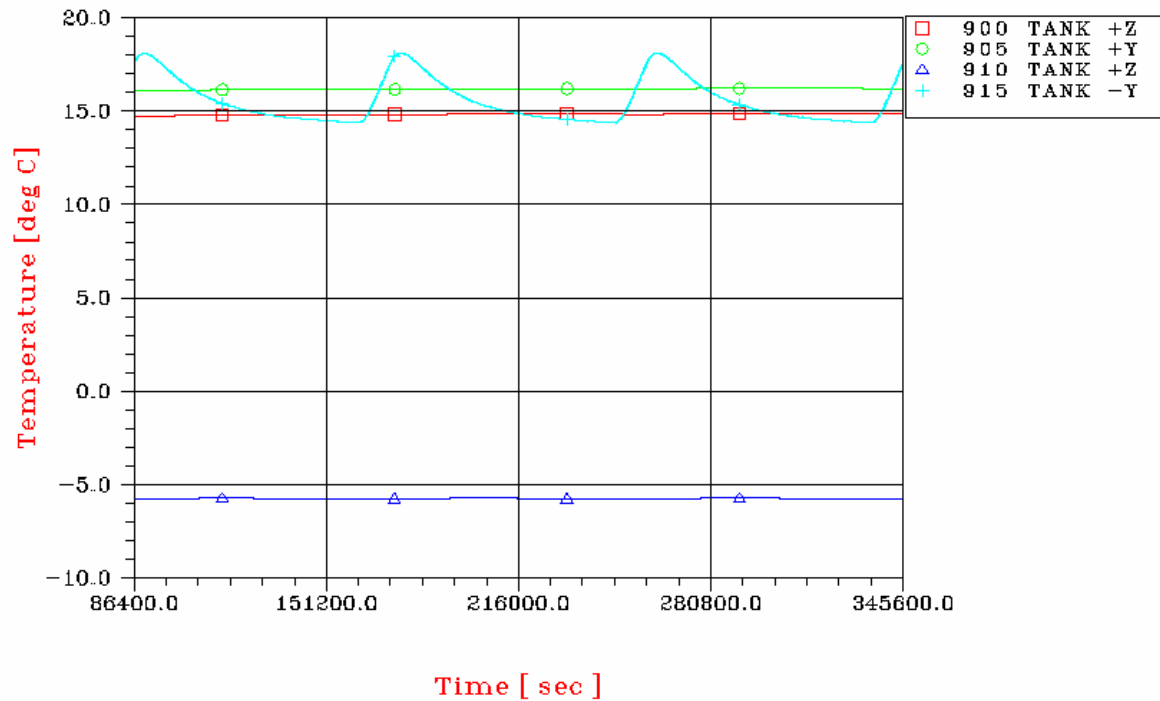

Figures 8.2-14 PLANCK - EOL CASE B2 He Tank



**Alcatel Alenia Space Italia S.p.A.**

**DOC. No : H-P-RP-AI-0040**  
**ISSUE : 05**  
**DATE : 24/FEB/06**  
**PAGE : 267 of 341**  
**CLASS. : DC**  
**ANNEXES : ..... Pages....**

### 11.3 PLANCK: PLOTS OF TRANSIENT NOMINAL ANALYSIS CASE C

In the following figures, the temperature plots of the transient nominal analysis concerning the satellite in BOL condition and Survival mode are presented.

PLANCK – CASE C BOL SURVIVAL

LATERAL PANEL +Z

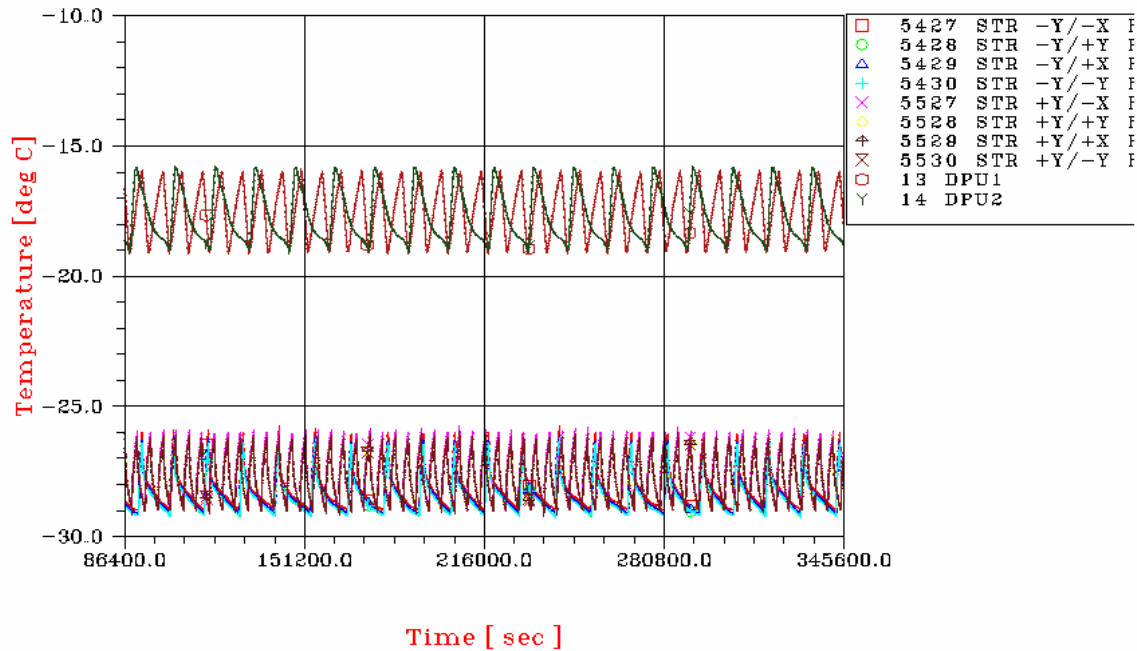

Figures 8.3-1 PLANCK - BOL CASE C +Z panel

PLANCK - CASE C BOL SURVIVAL

LATERAL PANEL +Z+Y

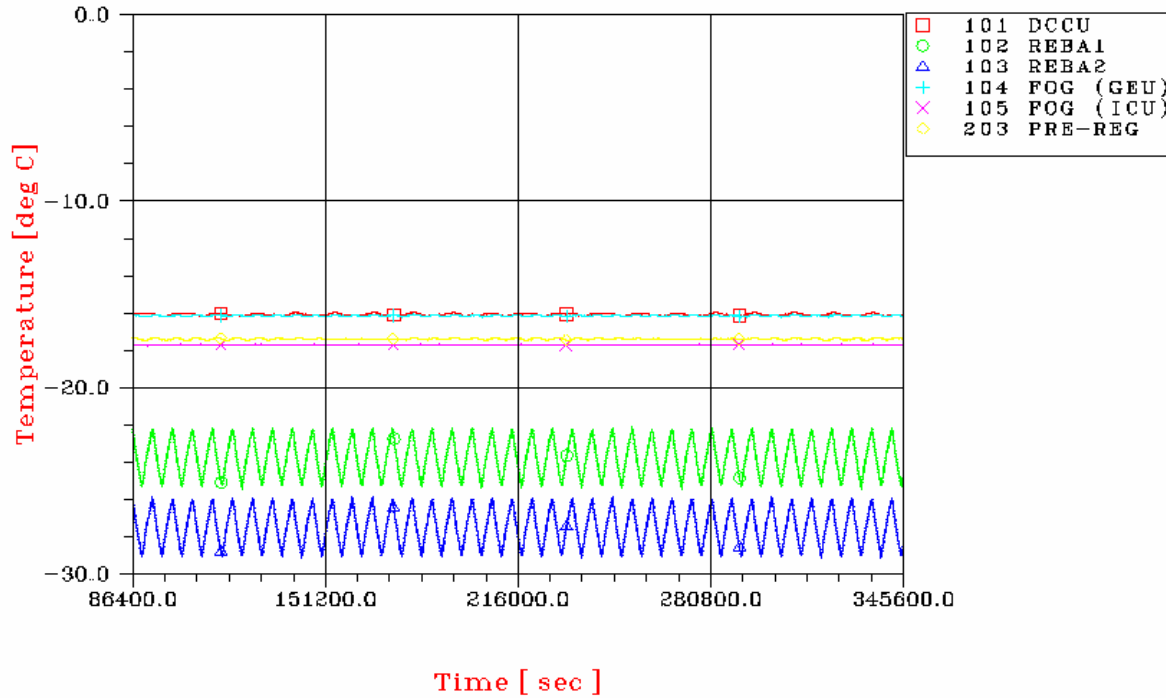

Figures 8.3-2 PLANCK - BOL CASE C +Y+Z panel

PLANCK – CASE C BOL SURVIVAL  
LATERAL PANEL +Y

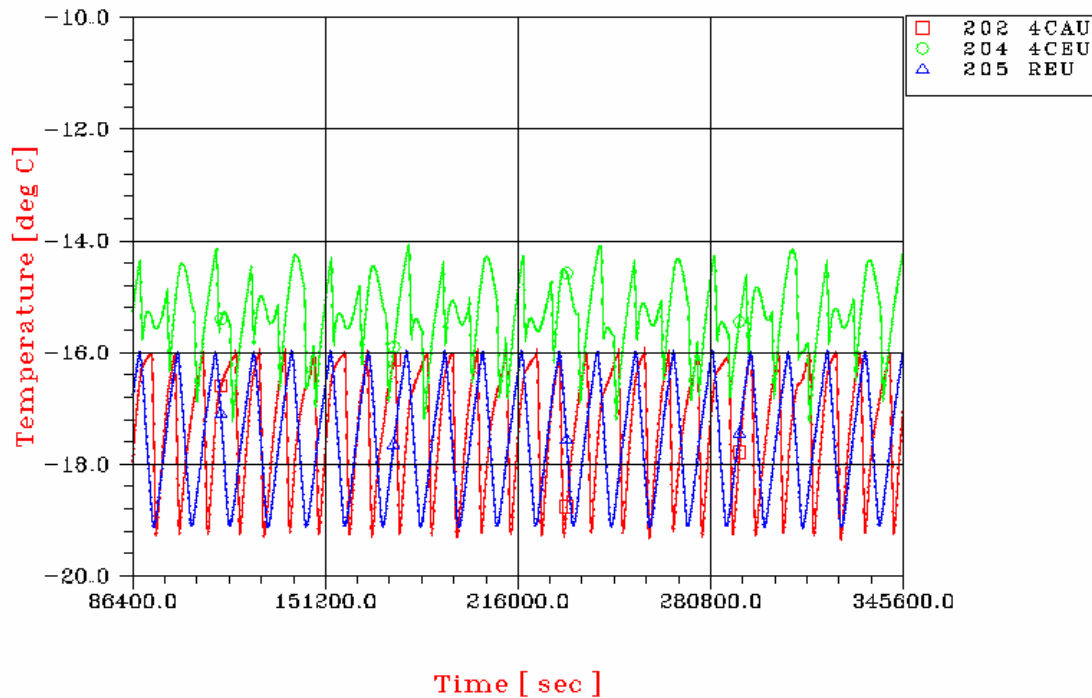

Figures 8.3-3 PLANCK - BOL CASE C +Y panel

PLANCK – CASE C BOL SURVIVAL

LATERAL PANEL +Y

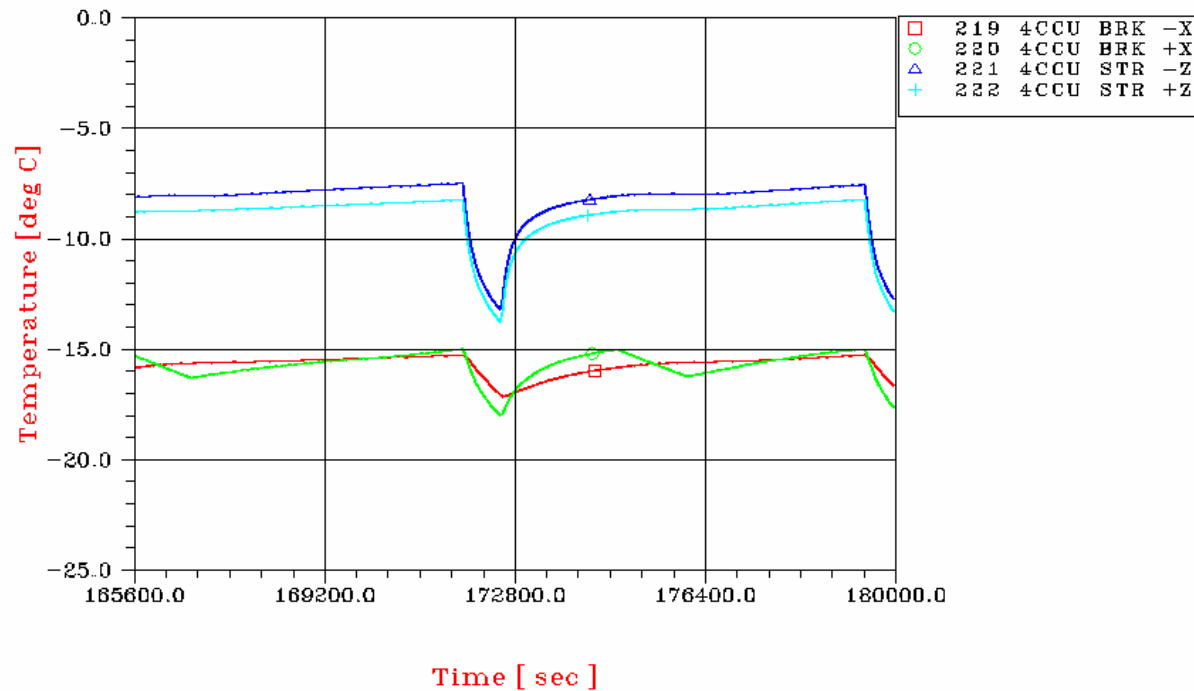

Figures 8.3-4 PLANCK - BOL CASE C - 4K CCU temperature

PLANCK – CASE C BOL SURVIVAL  
SCC1 ON

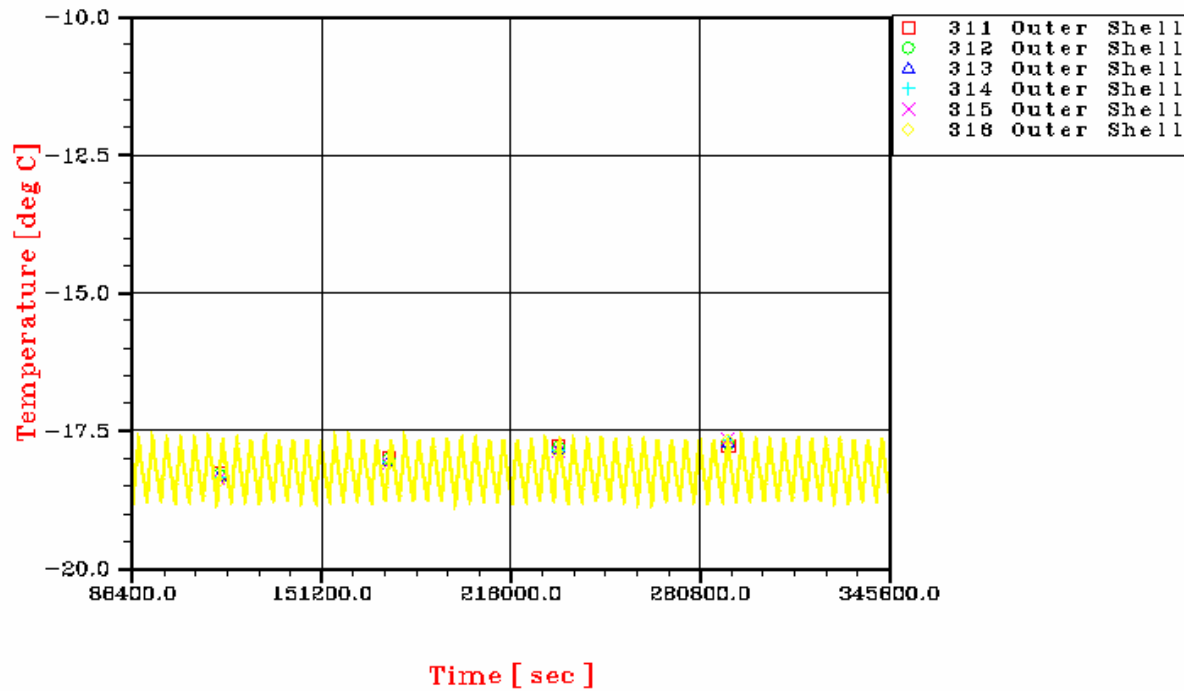

Figures 8.3-5 PLANCK - BOL CASE C +Y-Z panel



PLANCK – CASE C BOL SURVIVAL  
SCC1

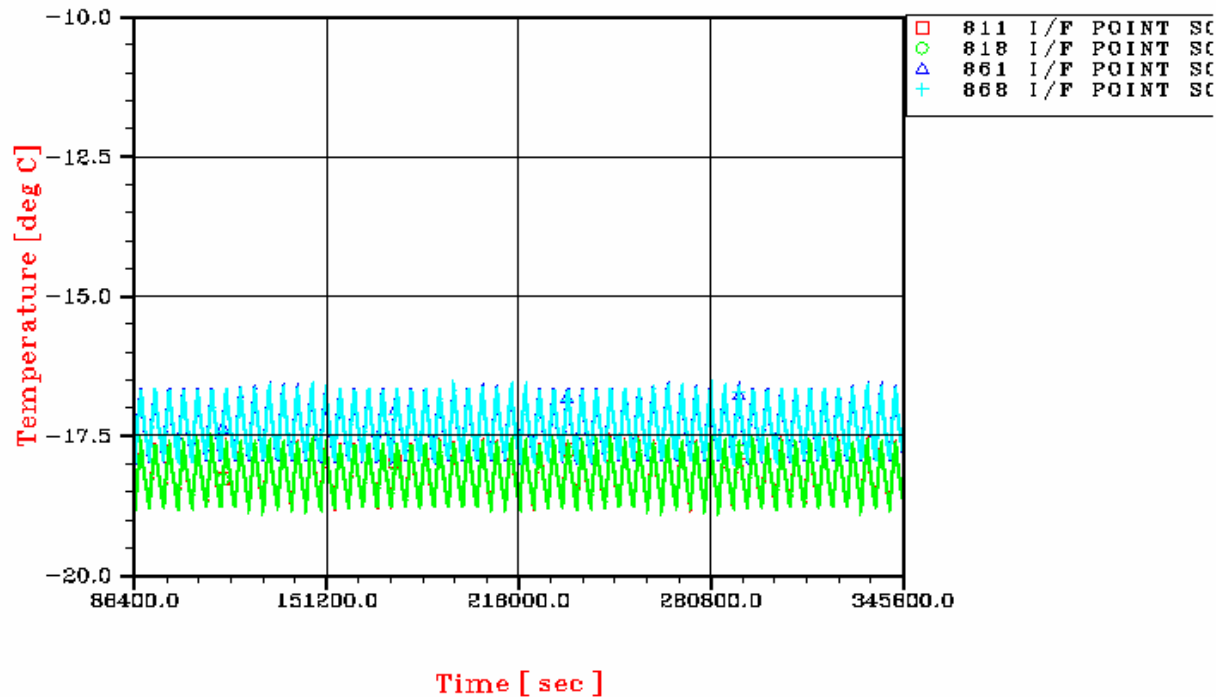

Figures 8.3-6 PLANCK - BOL CASE C SCC I/F temperature

PLANCK – CASE C BOL SURVIVAL

LATERAL PANEL –Z

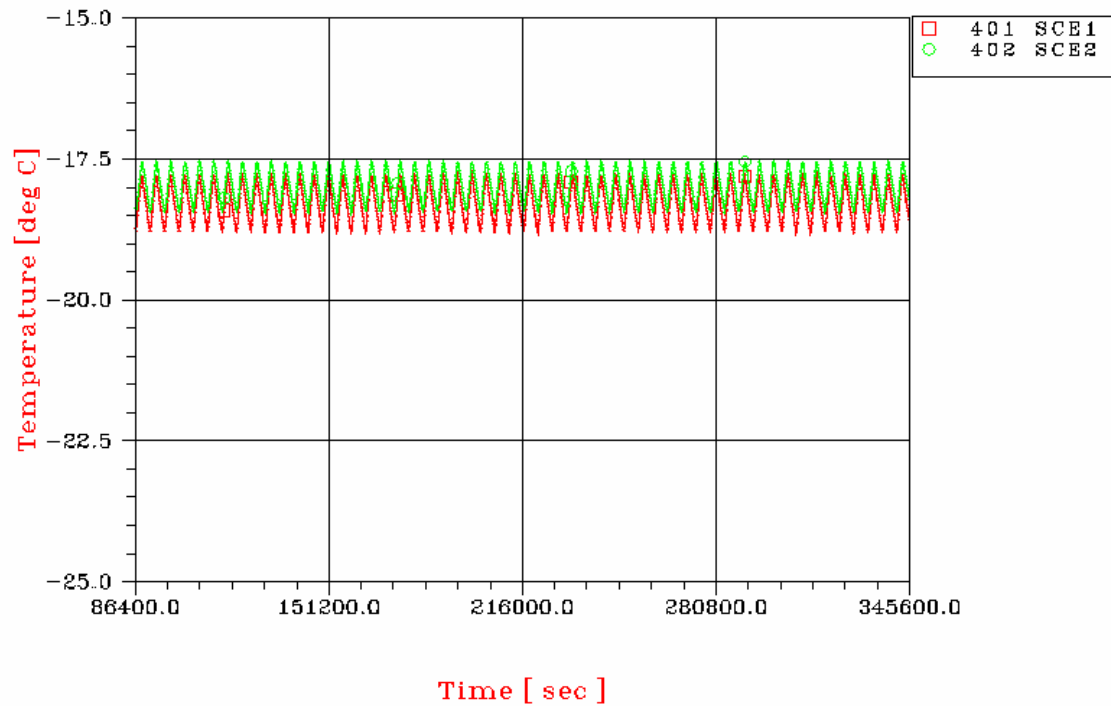

Figures 8.3-7 PLANCK - BOL CASE C -Z panel

**PLANCK – CASE C BOL SURVIVAL**  
**SCC2 OFF**

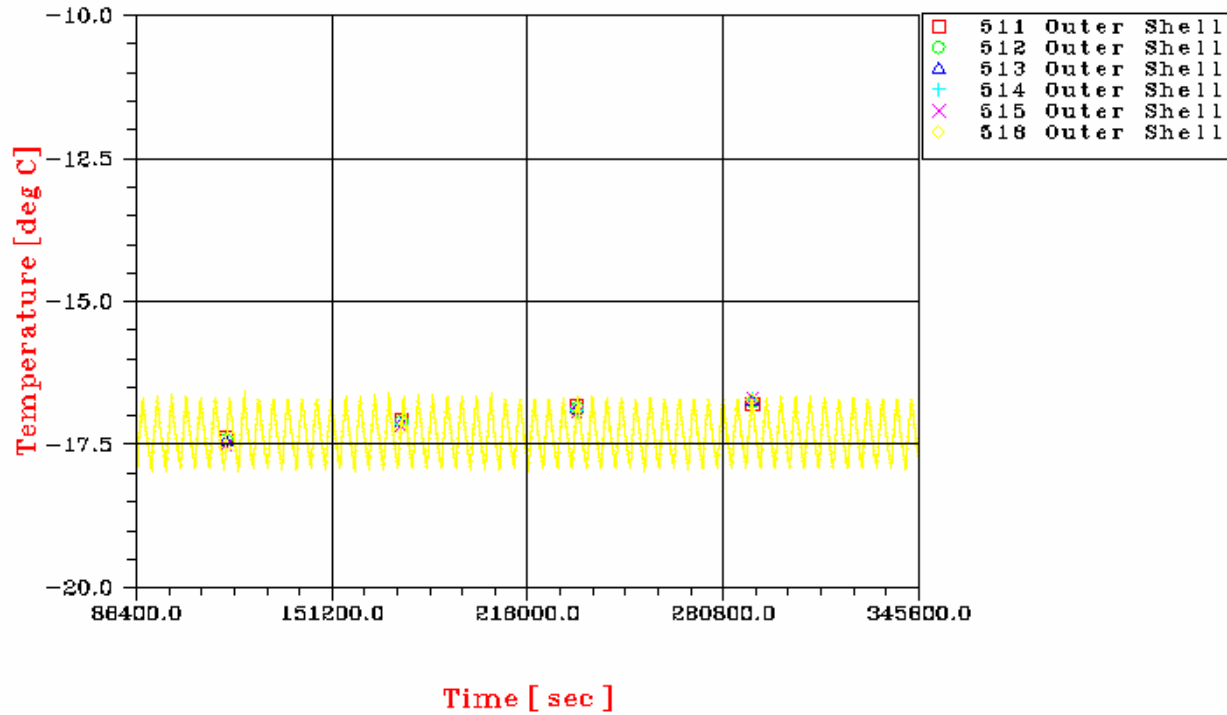

Figures 8.3-8 PLANCK - BOL CASE C -Y-Z panel

PLANCK – CASE C BOL SURVIVAL  
 LATERAL PANEL –Y

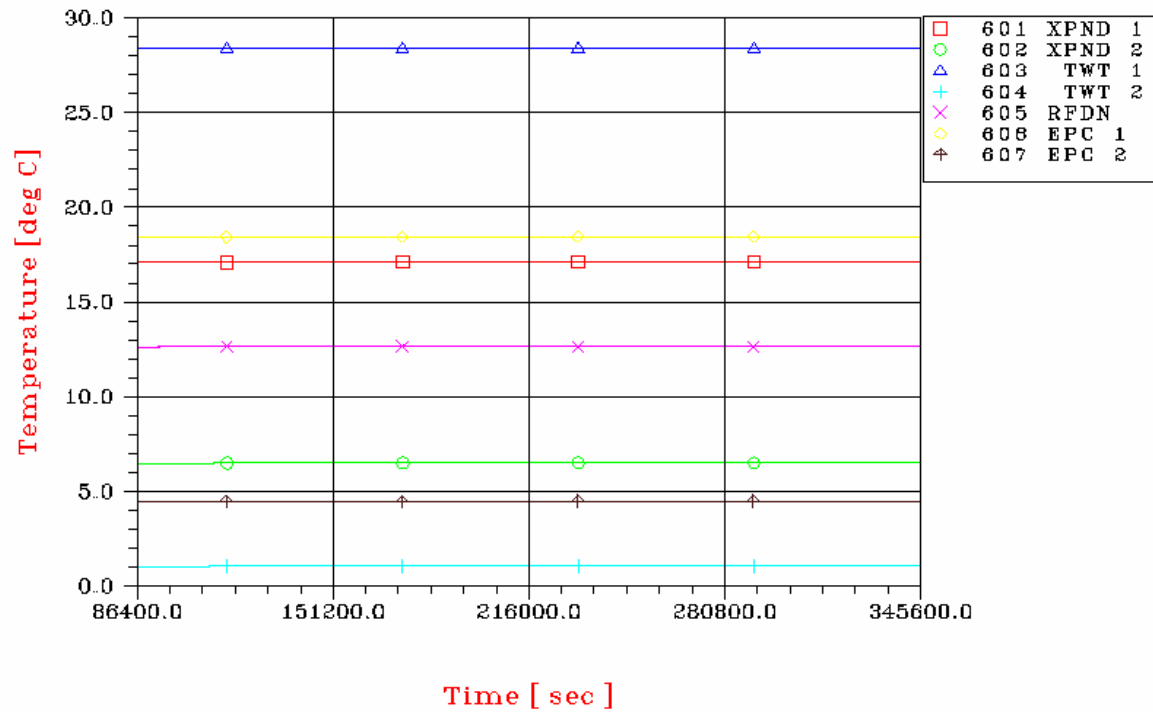

Figures 8.3-9 PLANCK - BOL CASE C -Y panel

PLANCK - CASE C BOL SURVIVAL  
 LATERAL PANEL +Z-Y

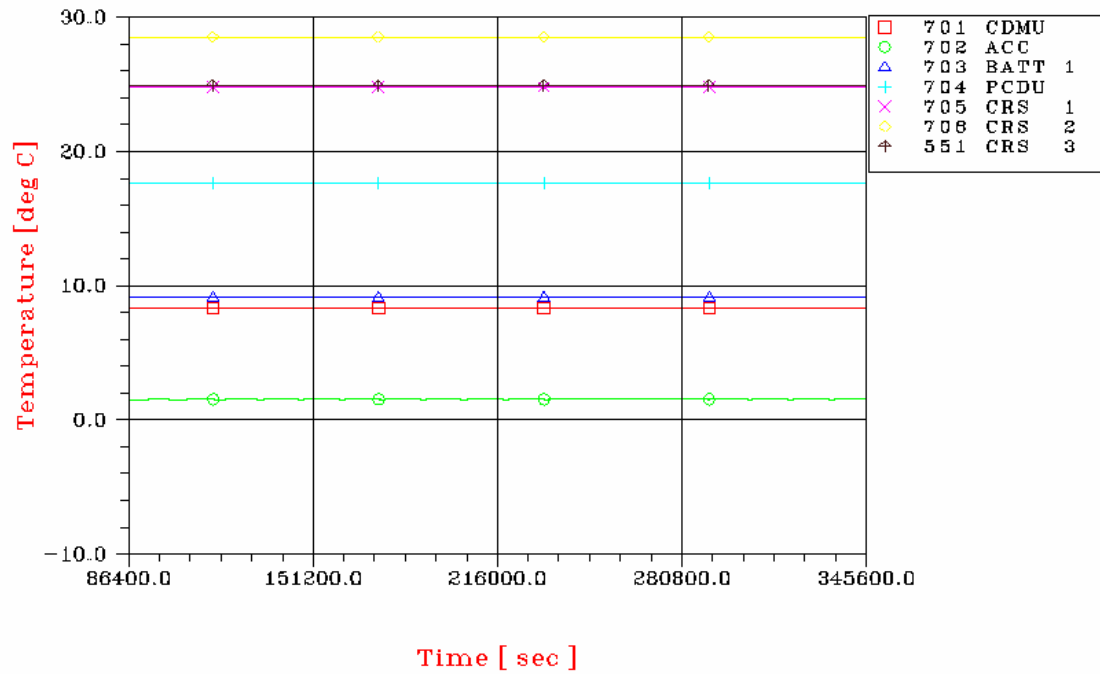

Figures 8.3-10 PLANCK - BOL CASE C -Y+Z panel

PLANCK – CASE C BOL SURVIVAL  
 SUBPLATFORM +X-X

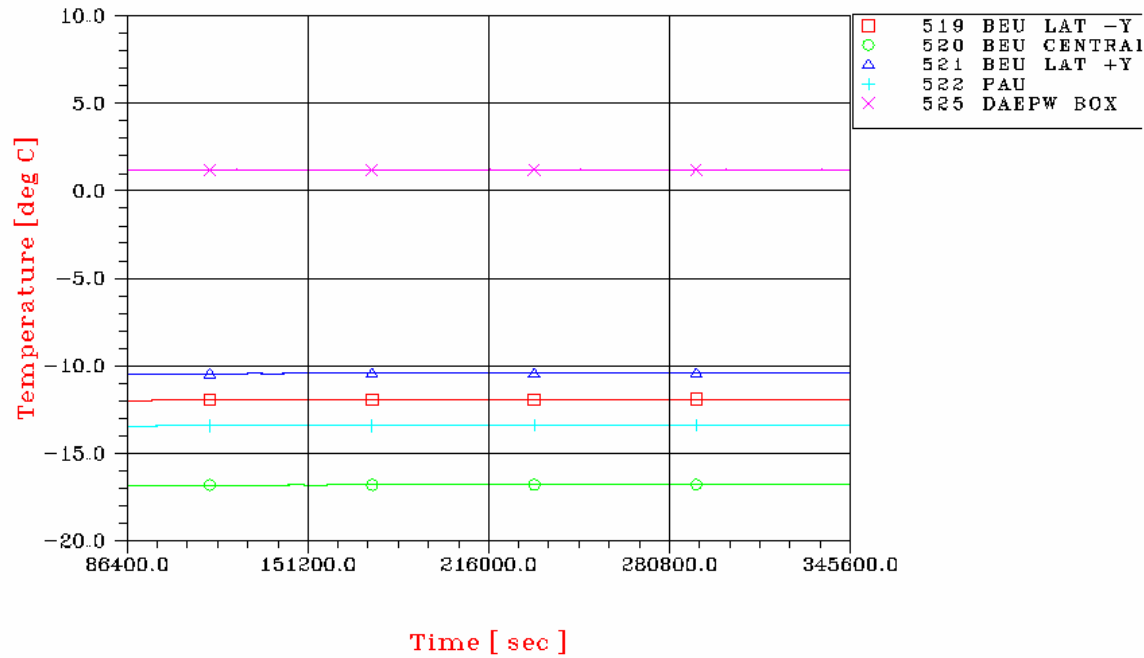

Figures 8.3-11 PLANCK - BOL CASE C subplatform panel

**PLANCK – CASE C BOL SURVIVAL  
PROPELLANT TANK**

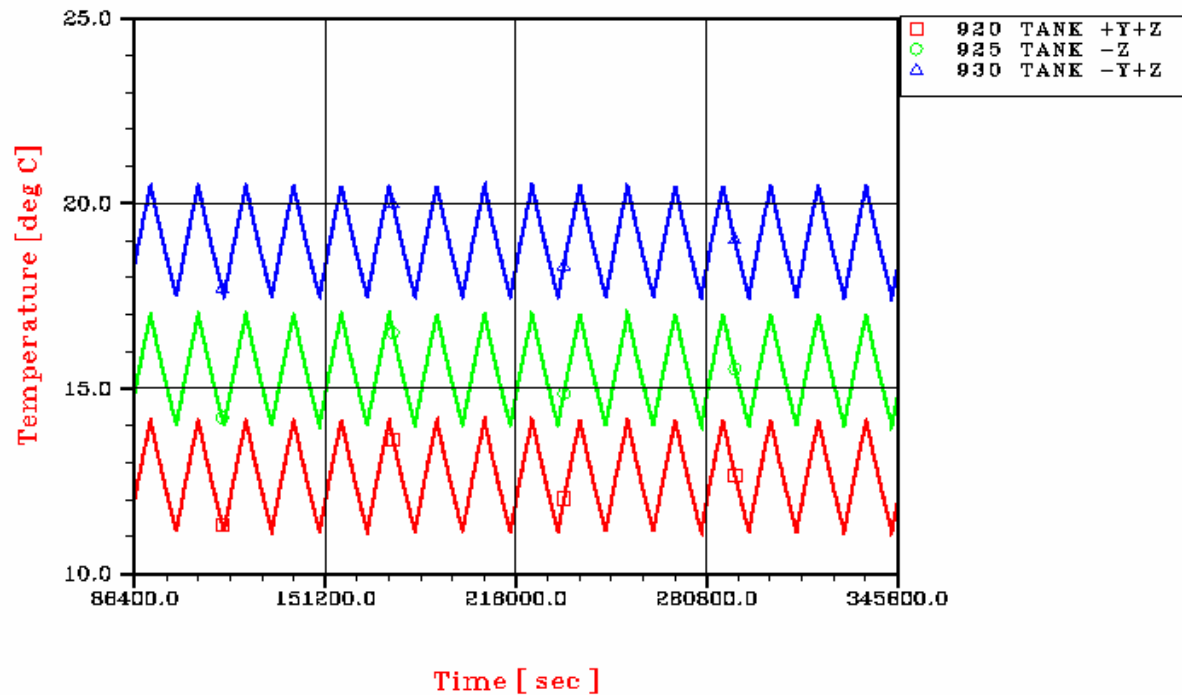

Figures 8.3-12 PLANCK - BOL CASE C propellant Tank

PLANCK – CASE C BOL SURVIVAL  
HE TANK

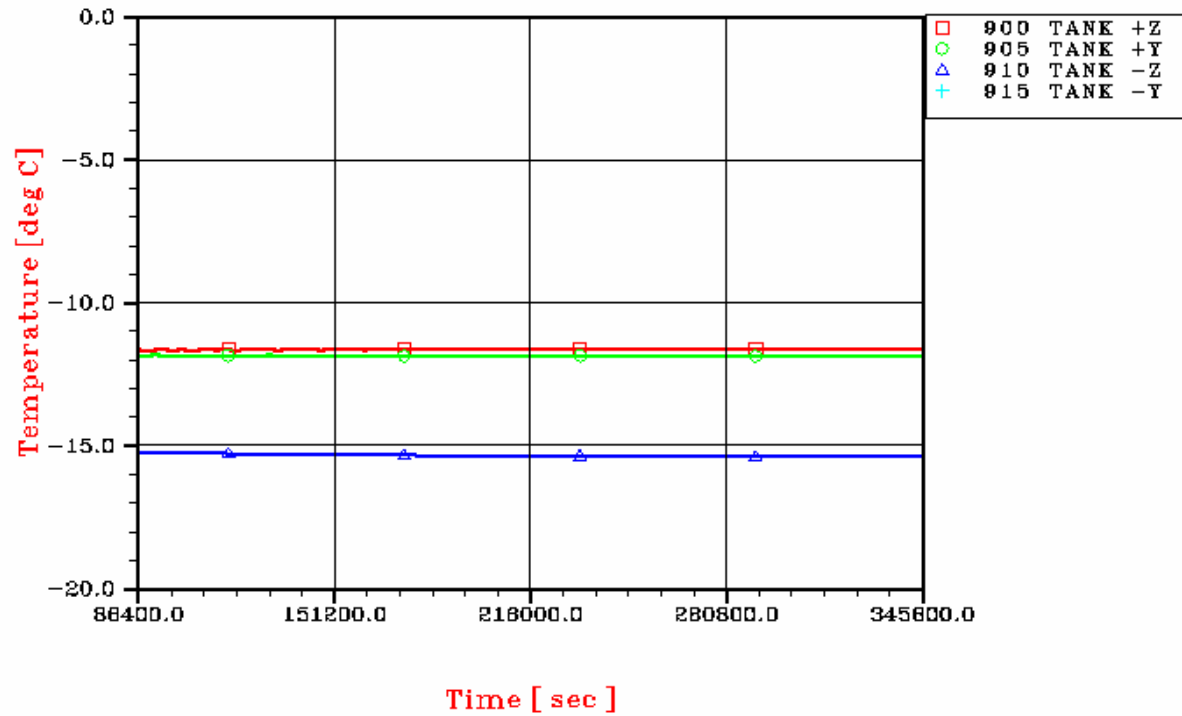

Figures 8.3-13 PLANCK - BOL CASE C He Tank





**Alcatel Alenia Space Italia S.p.A.**

**DOC. No : H-P-RP-AI-0040**  
**ISSUE : 05**  
**DATE : 24/FEB/06**  
**PAGE : 281 of 341**  
**CLASS. : DC**  
**ANNEXES : ..... Pages....**

#### 11.4 PLANCK: PLOTS OF TRANSIENT CASE P1

In the following figures, the temperature plots of the transient analysis concerning the attitude change of the satellite in BOL condition and unit SCC1 operative are presented.

Change of attitude at time=86400s

PLANCK ATTITUDE CHANGE CASE P1

LATERAL PANEL +Z

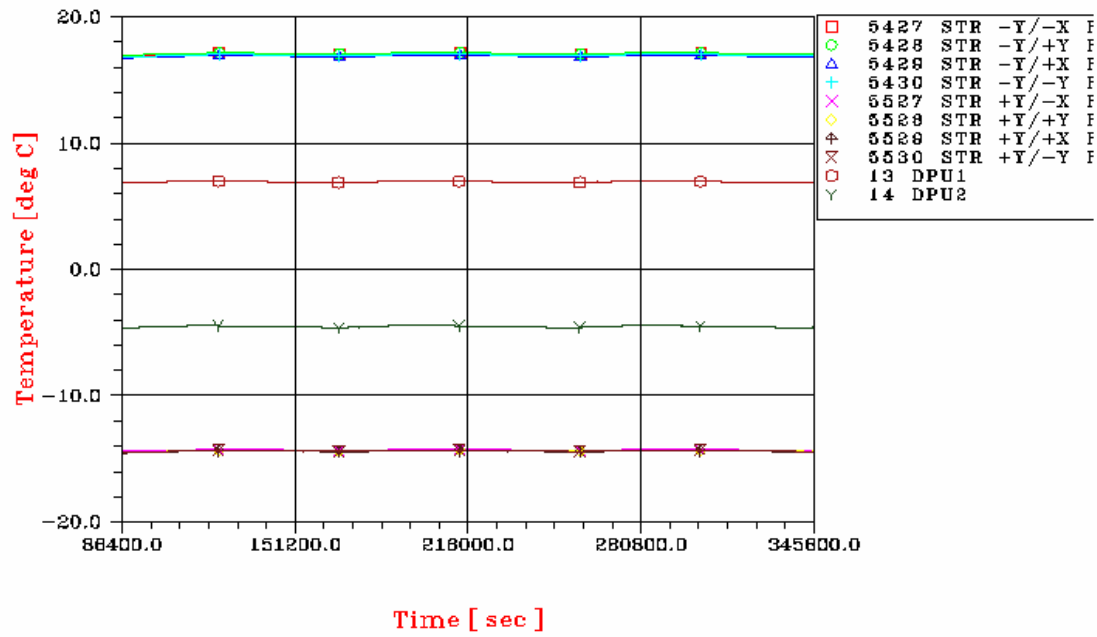

Figures 8.4-1 PLANCK - BOL attitude change +Z panel

**PLANCK ATTITUDE CHANGE CASE P1**  
**LATERAL PANEL +Z+Y**

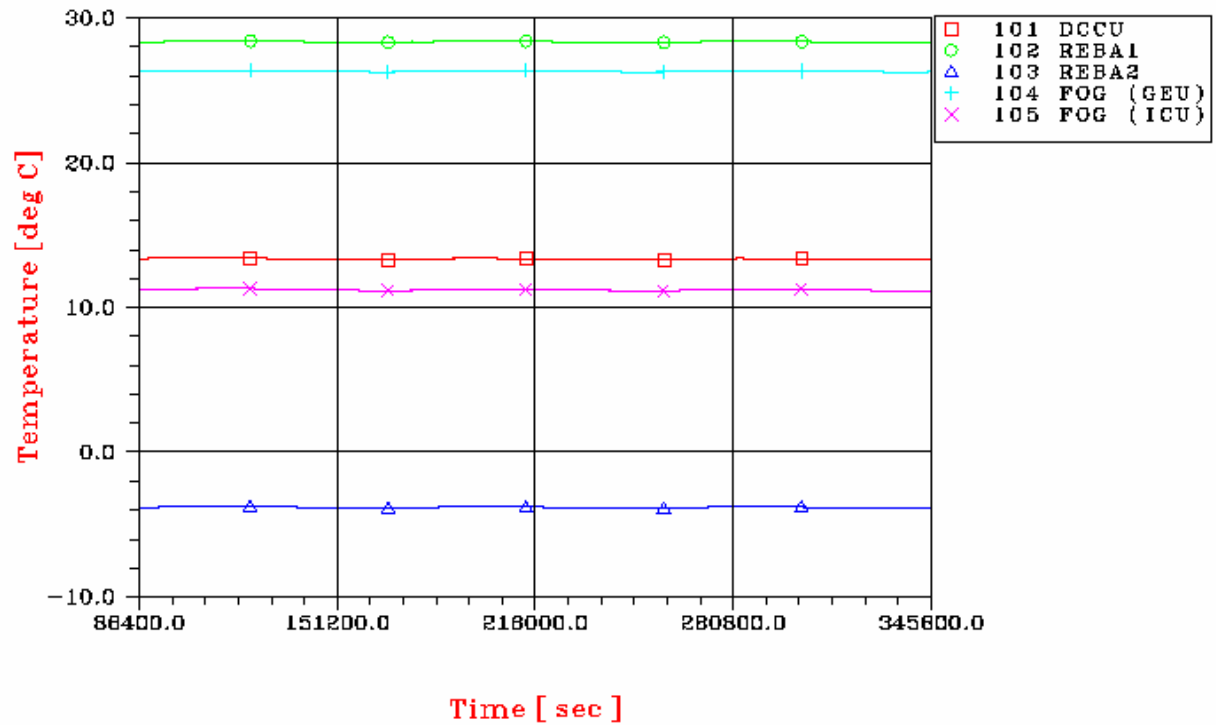

Figures 8.4-2 PLANCK - BOL attitude change +Y+Z panel

PLANCK ATTITUDE CHANGE CASE P1  
 LATERAL PANEL +Y

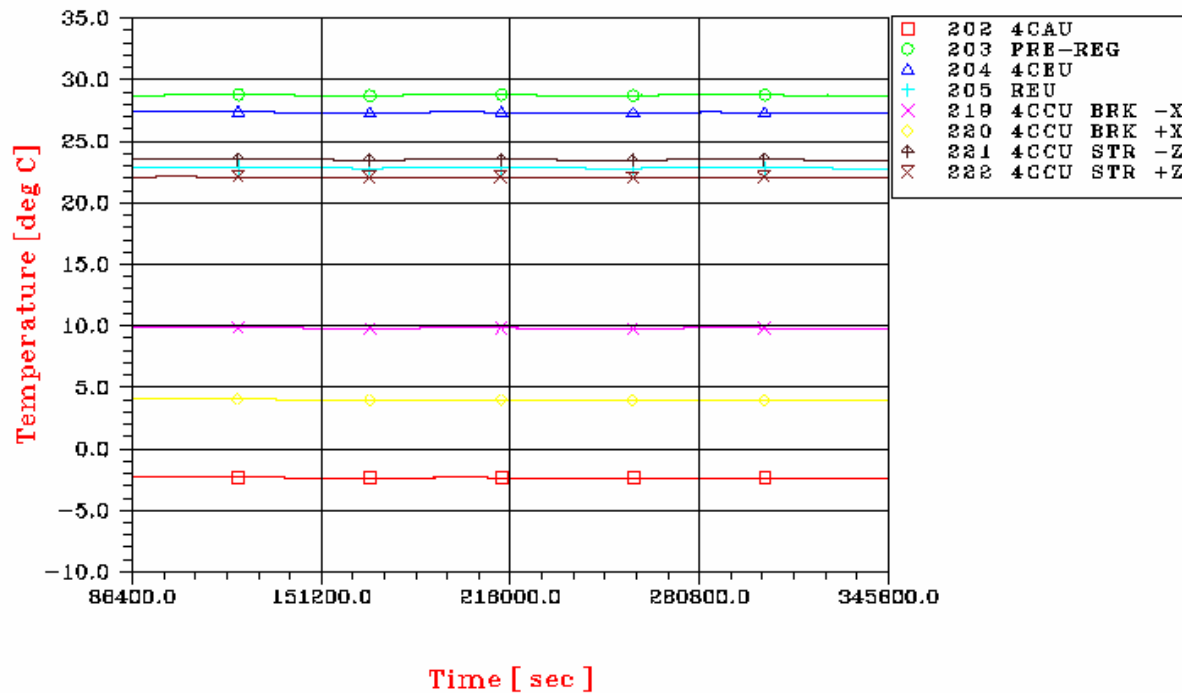

Figures 8.4-3 PLANCK - BOL attitude change +Y panel

## PLANCK ATTITUDE CHANGE CASE P1

SCC1 ON

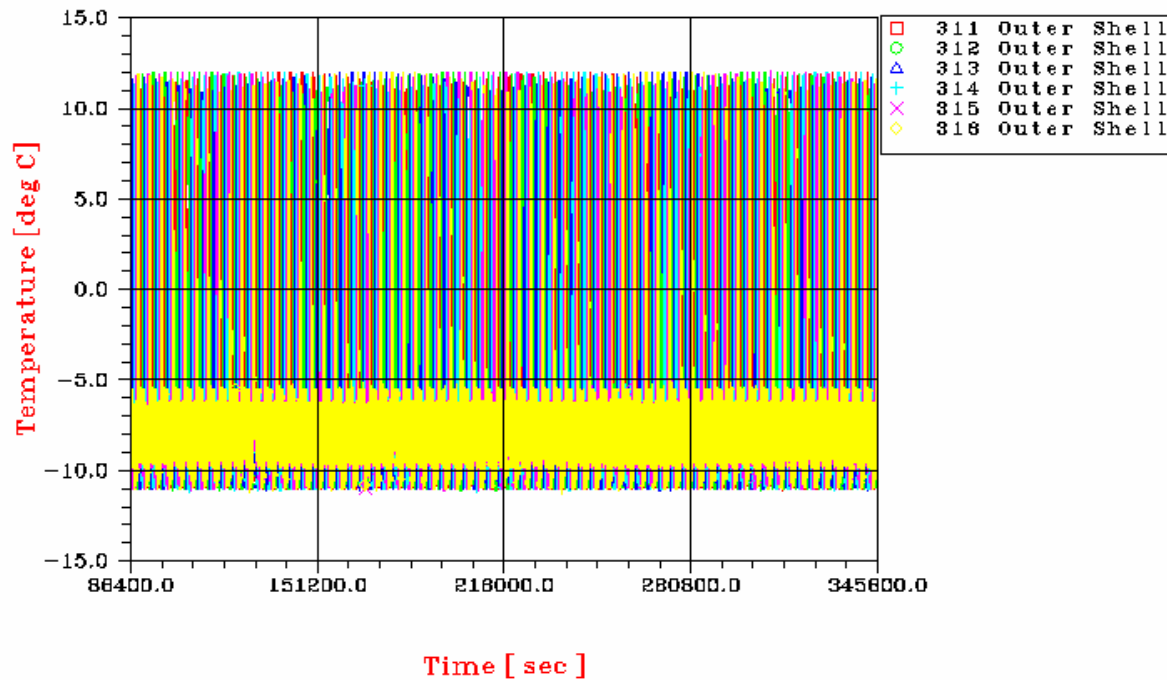

Figures 8.4-4 PLANCK - BOL attitude change +Y-Z panel

## PLANCK ATTITUDE CHANGE CASE P1

SCC1 ON

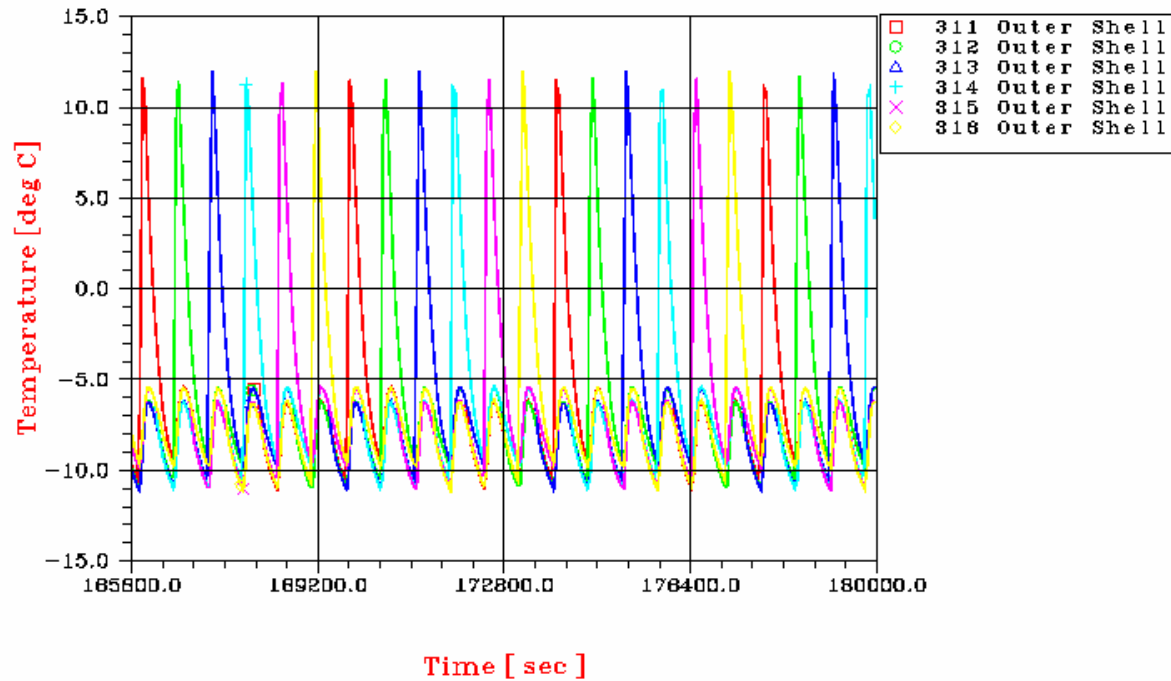

Figures 8.4-5 PLANCK - BOL attitude change +Y-Z panel

## PLANCK ATTITUDE CHANGE CASE P1

### SCC1

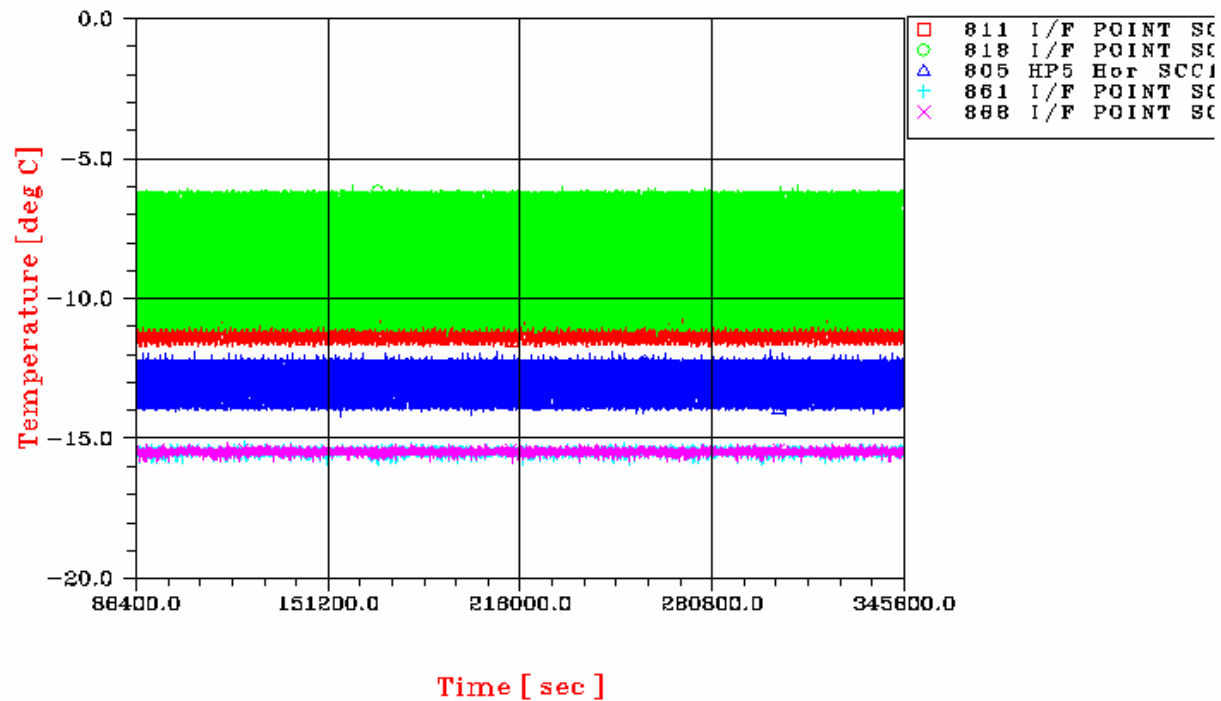

Figures 8.4-6 PLANCK - BOL attitude change SCC I/F temperatures

PLANCK ATTITUDE CHANGE CASE P1

SCC1

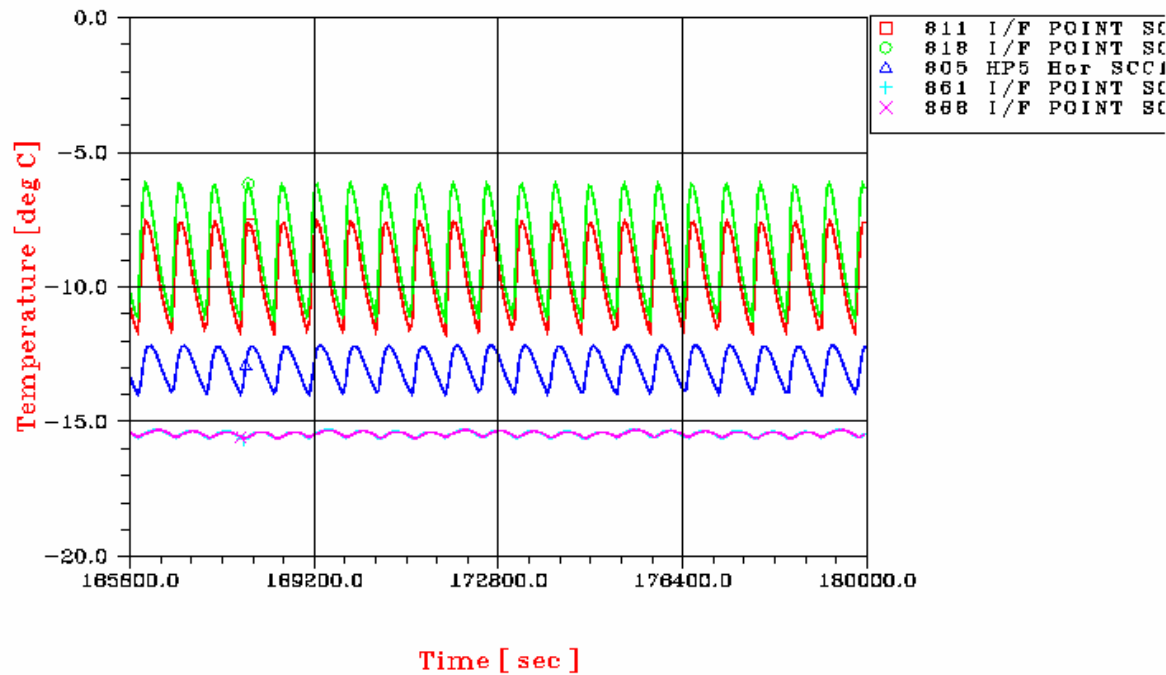

Figures 8.4-7 PLANCK - BOL attitude change SCC I/F temperatures



## PLANCK ATTITUDE CHANGE CASE P1

### LATERAL PANEL - Z

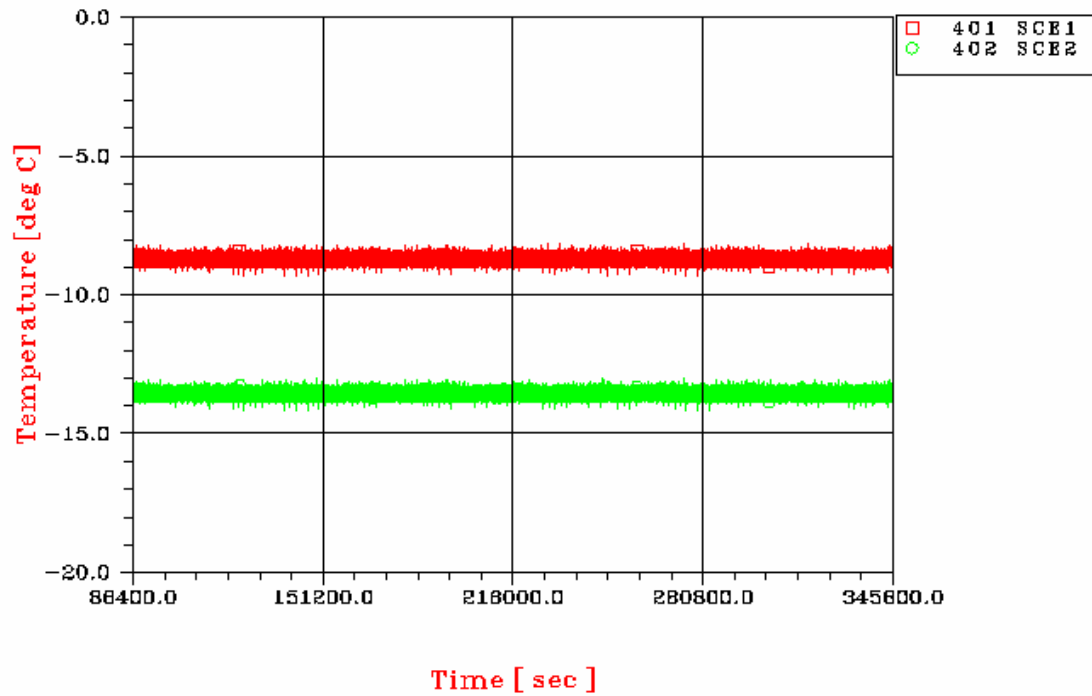

Figures 8.4-8 PLANCK - BOL attitude change -Z panel

## PLANCK ATTITUDE CHANGE CASE P1

SCC2 OFF

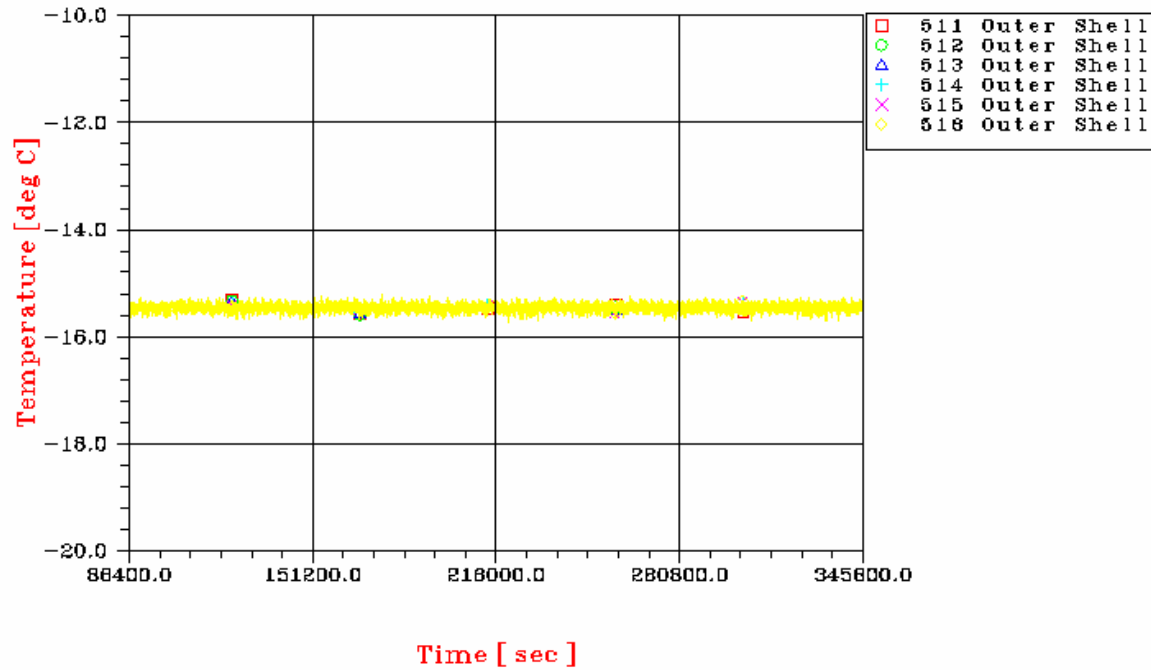

Figures 8.4-9 PLANCK - BOL attitude change -Y-Z panel

PLANCK ATTITUDE CHANGE CASE P1  
 LATERAL PANEL -Y

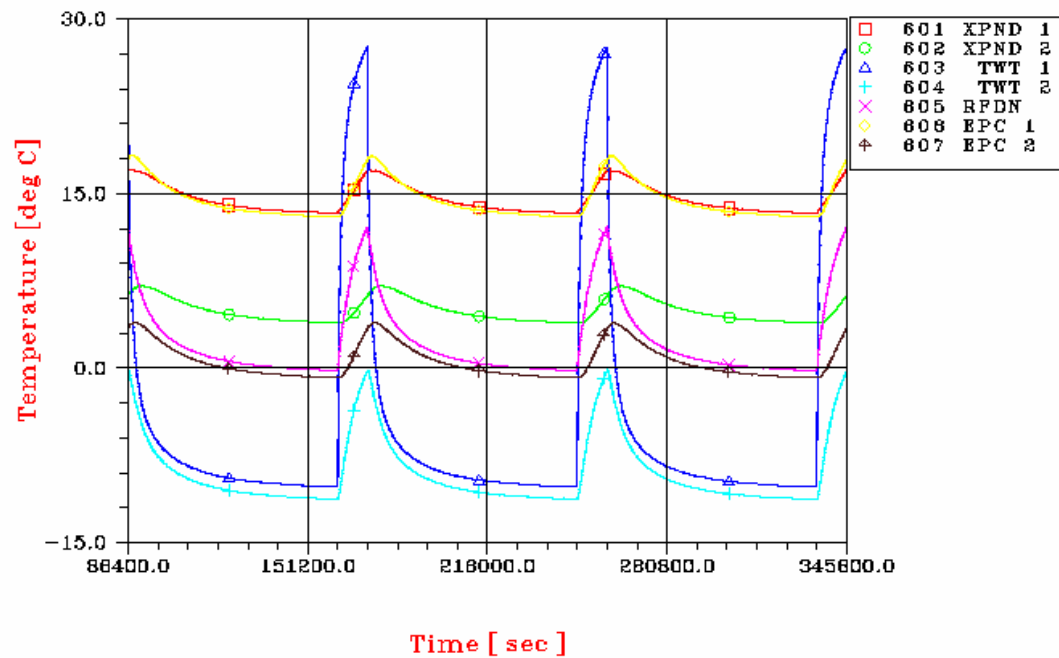

Figures 8.4-10 PLANCK - BOL attitude change -Y panel

**PLANCK ATTITUDE CHANGE CASE P1**  
**LATERAL PANEL +Z-Y**

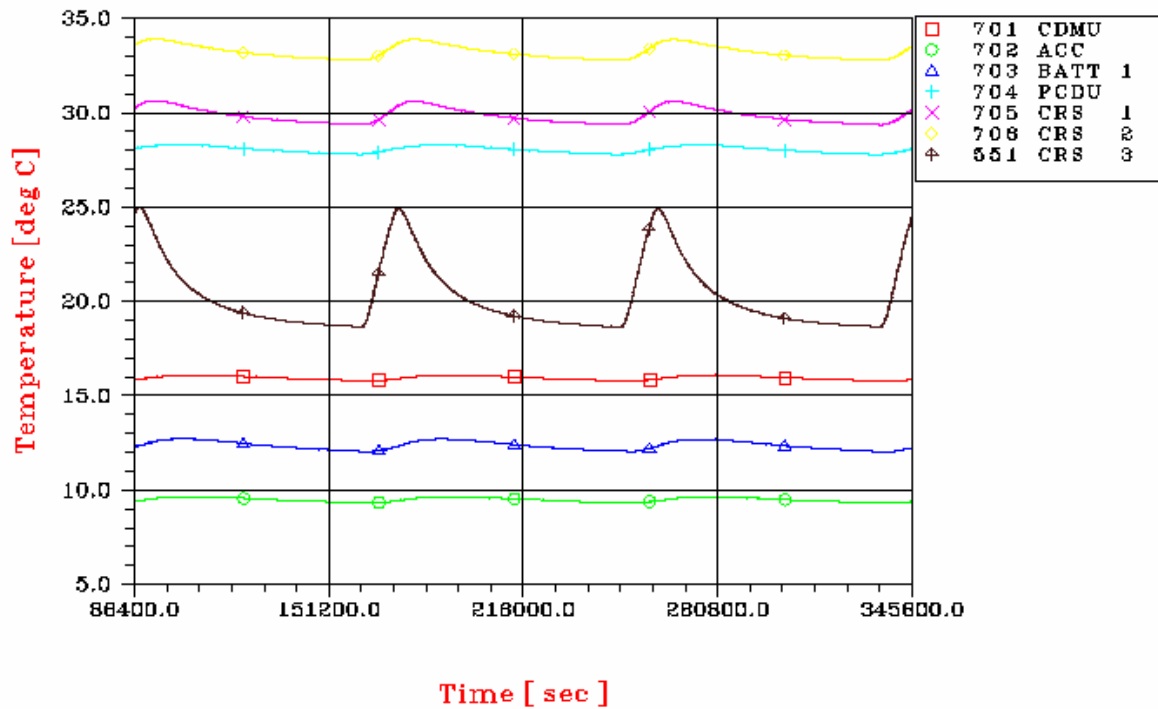

Figures 8.4-11 PLANCK - BOL attitude change -Y+Z panel

PLANCK ATTITUDE CHANGE CASE P1  
 SUBPLATFORM +X-X

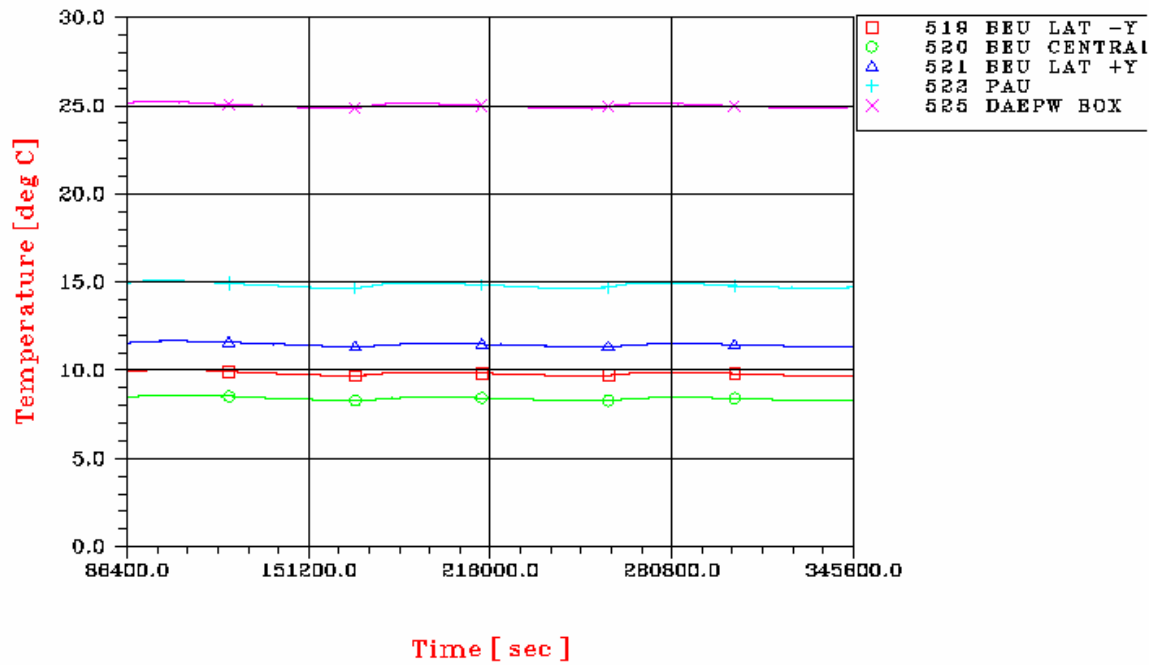

Figures 8.4-12 PLANCK - BOL attitude change subplatform panel

PLANCK ATTITUDE CHANGE CASE P1

HE TANK

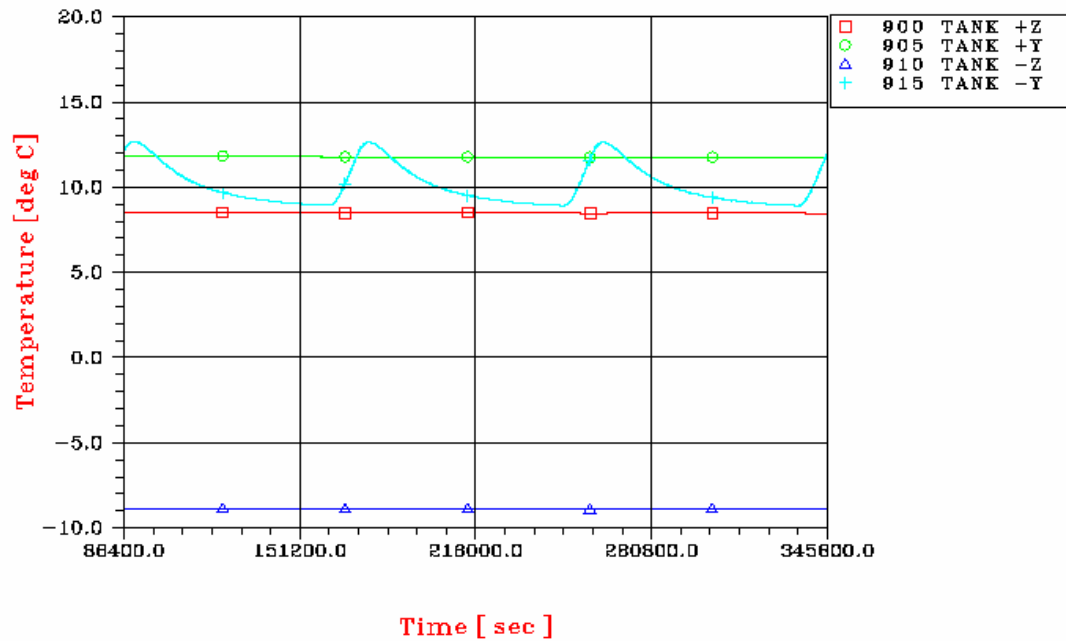

Figures 8.4-13 PLANCK - BOL attitude change Helium TANK

PLANCK ATTITUDE CHANGE CASE P1  
PROPELLANT TANK

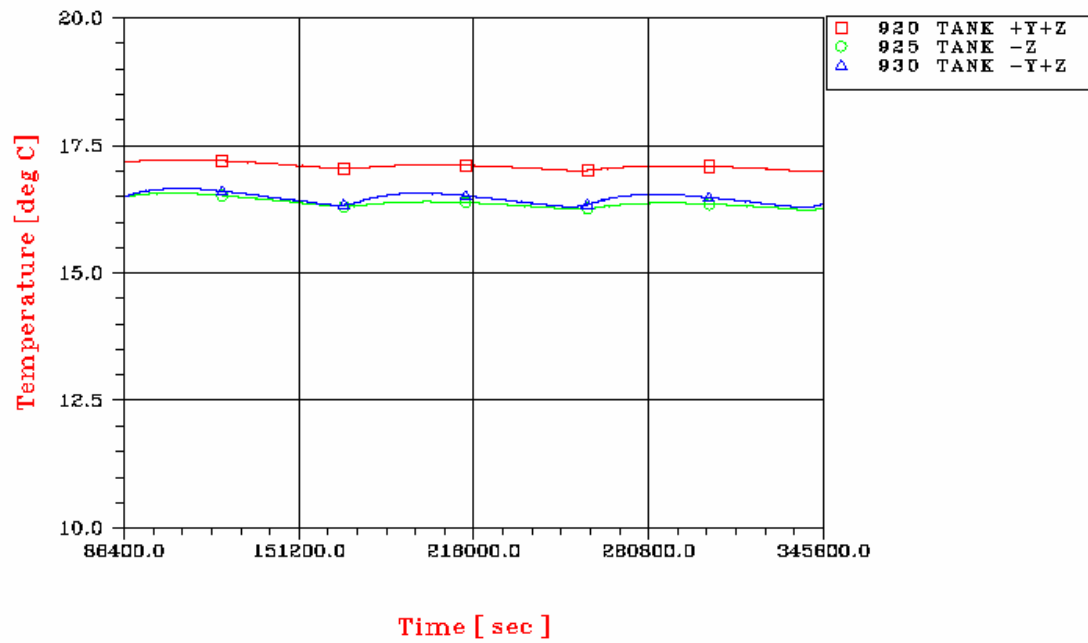

Figures 8.4-14 PLANCK - BOL attitude change Propellant TANK



**Alcatel Alenia Space Italia S.p.A.**

**DOC. No : H-P-RP-AI-0040**  
**ISSUE : 05**  
**DATE : 24/FEB/06**  
**PAGE : 296 of 341**  
**CLASS. : DC**  
**ANNEXES : ..... Pages....**

### 11.5 PLANCK: PLOTS OF TRANSIENT CASE P2

In the following figures, the temperature plots of the transient analysis concerning the attitude change of the satellite in BOL condition and unit SCC2 operative are presented.

Change of attitude at time=86400s



**PLANCK ATTITUDE CHANGE CASE P2**  
**LATERAL PANEL +Z**

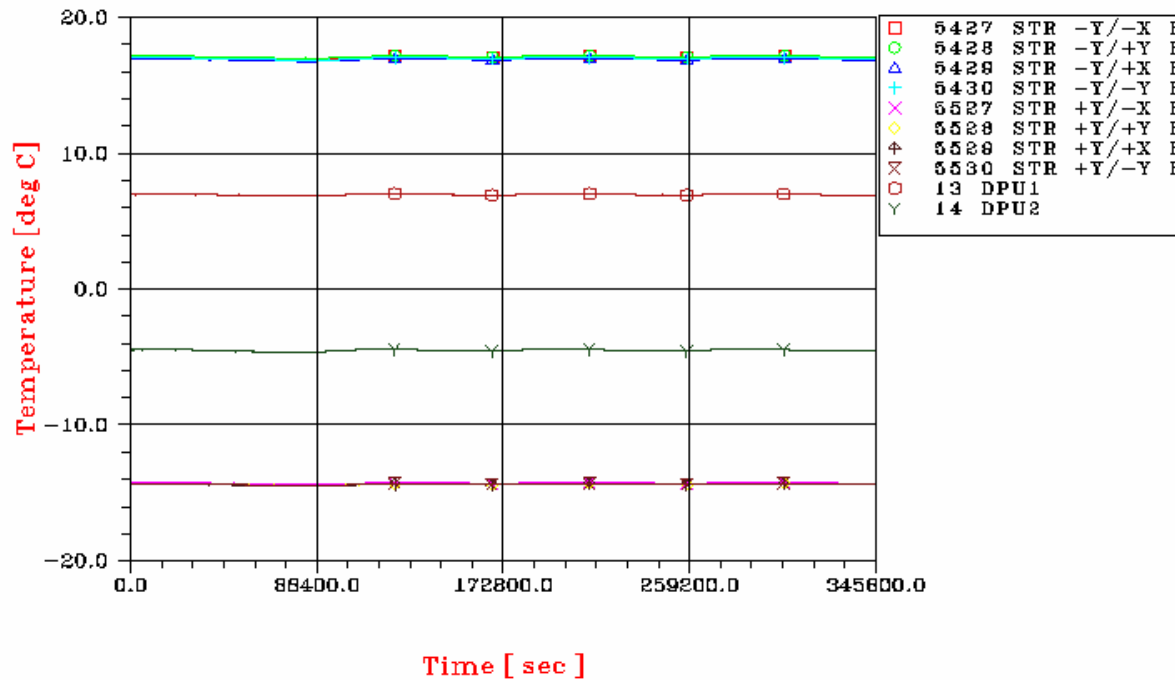

Figures 8.5-1 PLANCK - BOL attitude change +Z panel

PLANCK ATTITUDE CHANGE CASE P2

LATERAL PANEL +Z+Y

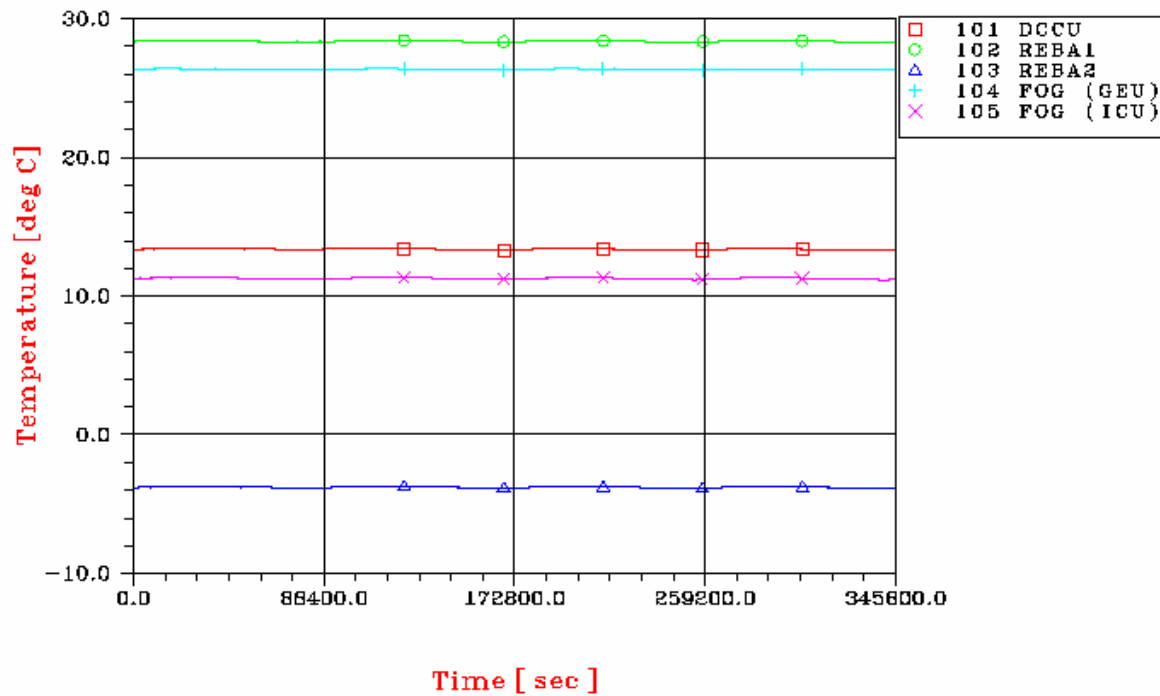

Figures 8.5-2 PLANCK - BOL attitude change +Y+Z panel

**PLANCK ATTITUDE CHANGE CASE P2**  
**LATERAL PANEL +Y**

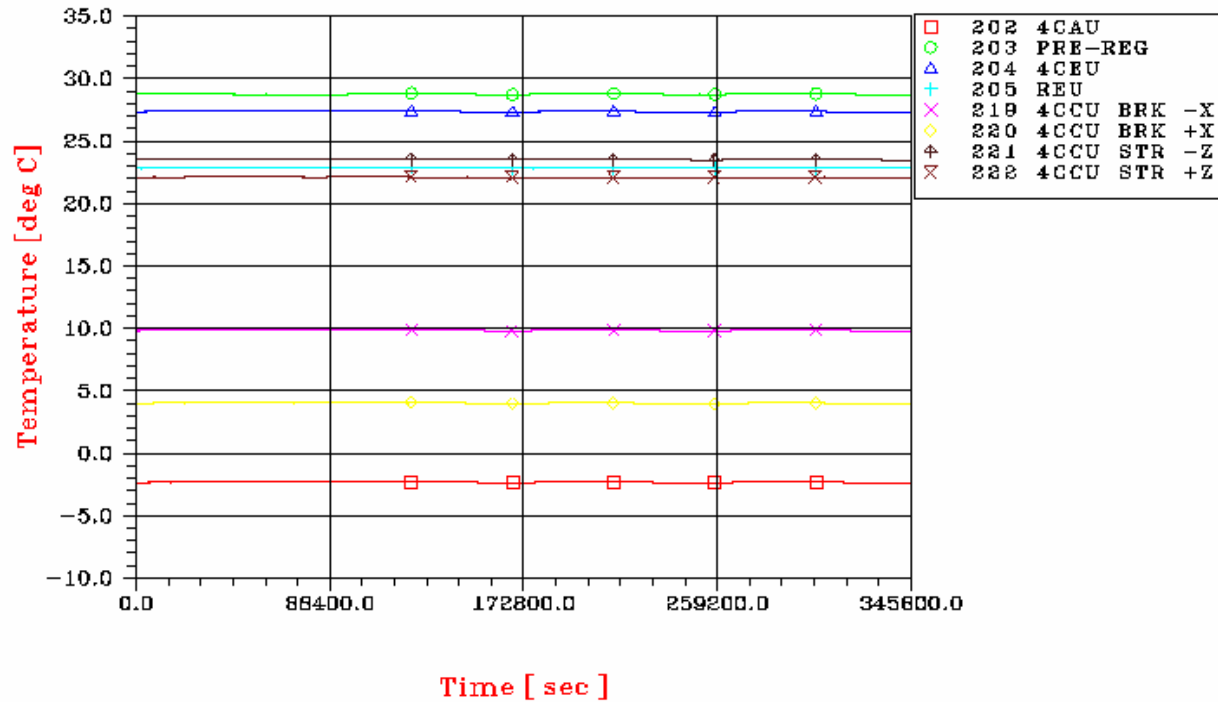

Figures 8.5-3 PLANCK - BOL attitude change +Y panel

### PLANCK ATTITUDE CHANGE CASE P2

SCC1

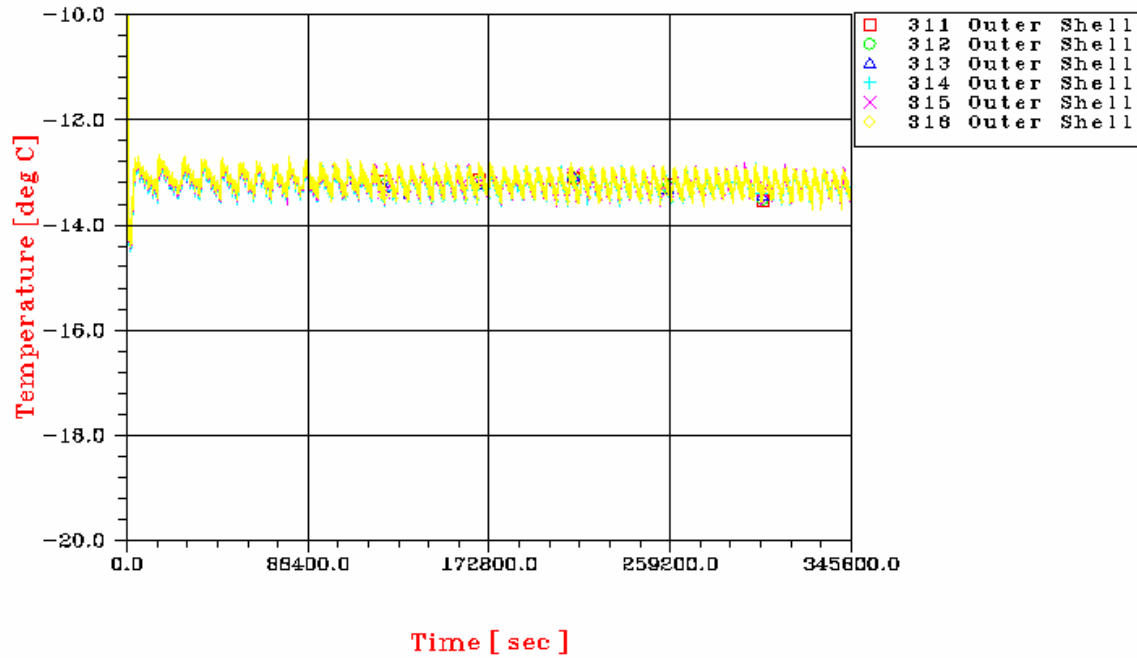

Figures 8.5-4 PLANCK - BOL attitude change +Y-Z panel

### PLANCK ATTITUDE CHANGE CASE P2

SCC1

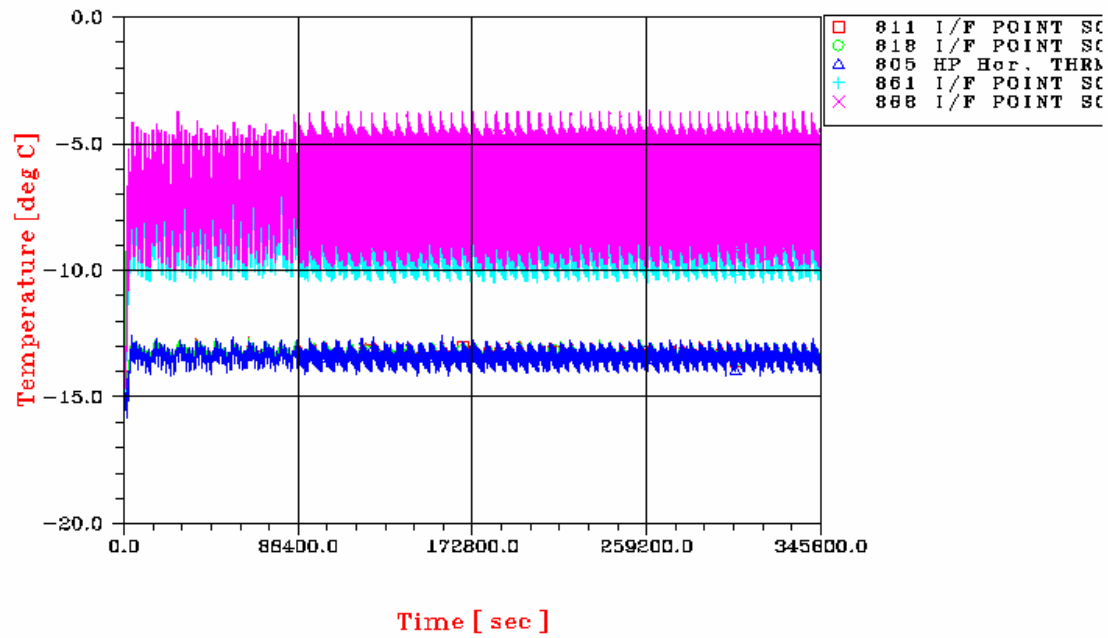

Figures 8.5-5 PLANCK - BOL attitude change SCC I/F temperatures

## PLANCK ATTITUDE CHANGE CASE P2

### SCC1

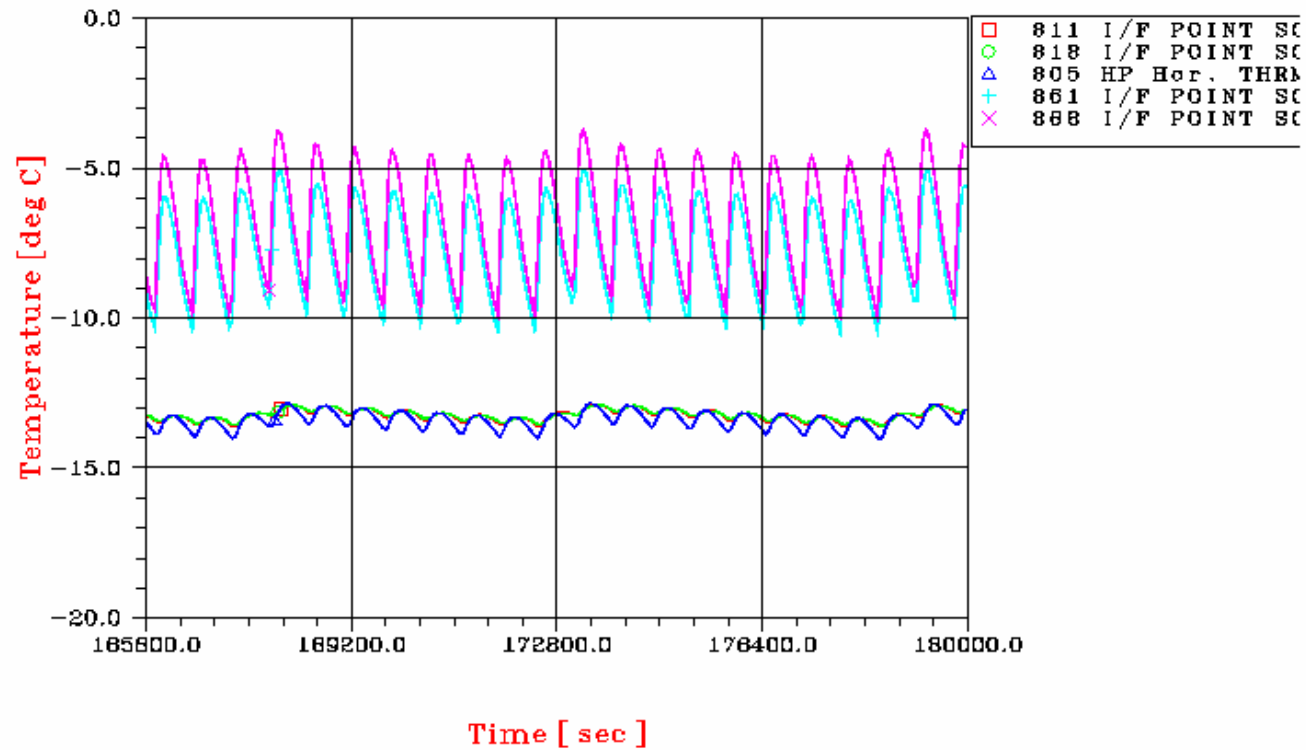

Figures 8.5-6 PLANCK - BOL attitude change SCC I/F temperatures

## PLANCK ATTITUDE CHANGE CASE P2

### LATERAL PANEL - Z

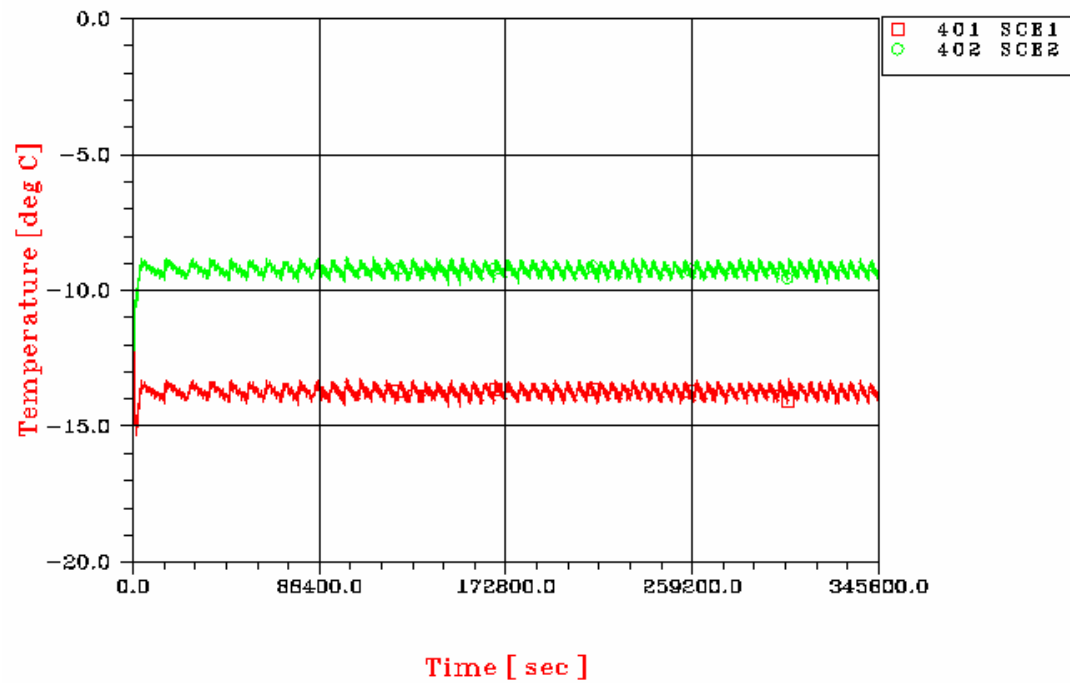

Figures 8.5-7 PLANCK - BOL attitude change -Z panel

## PLANCK ATTITUDE CHANGE CASE P2

### SCC2

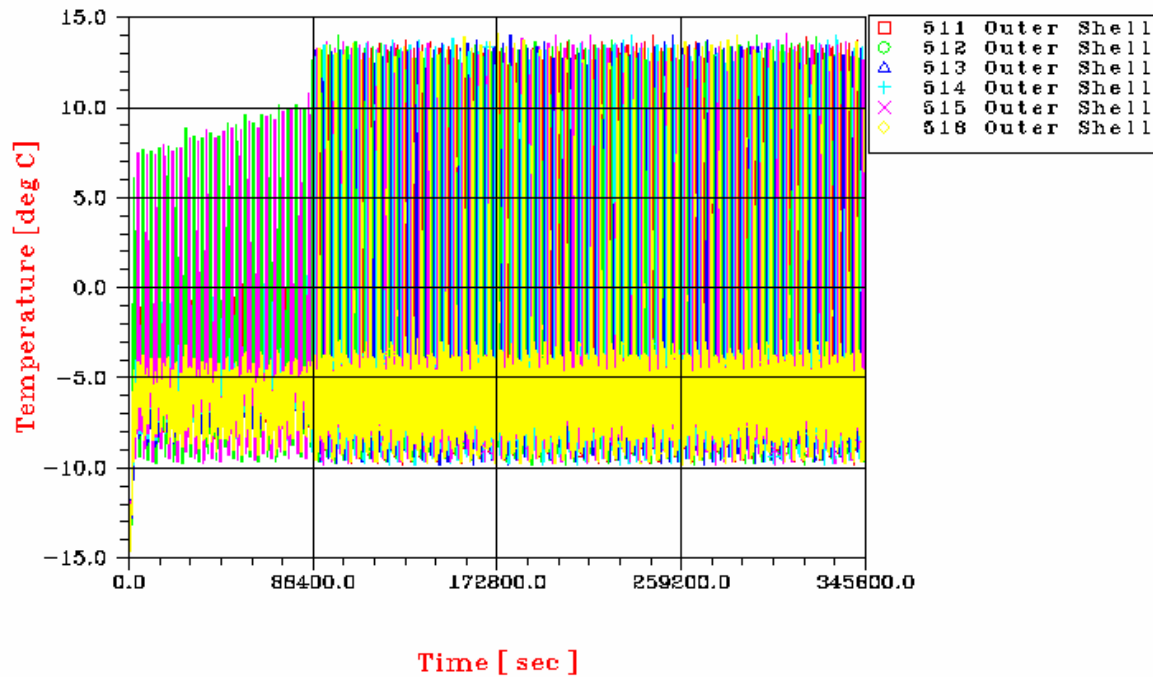

Figures 8.5-8 PLANCK - BOL attitude change -Y-Z panel



PLANCK ATTITUDE CHANGE CASE P2  
SCC2

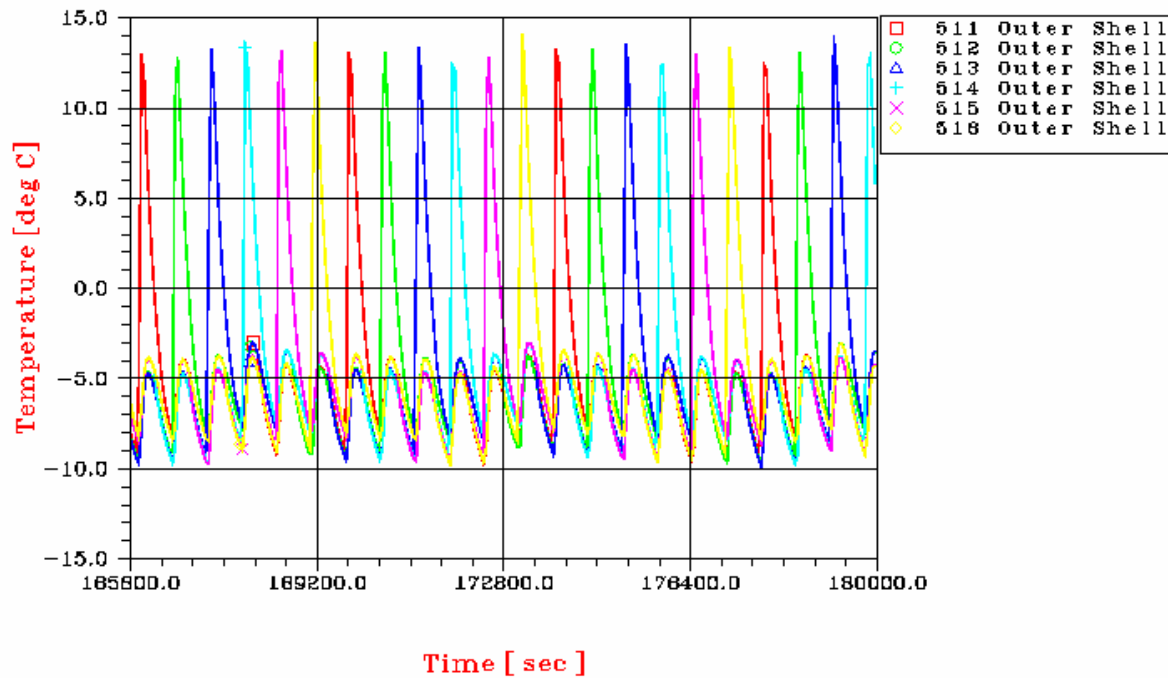

Figures 8.5-9 PLANCK - BOL attitude change -Y-Z panel

**PLANCK ATTITUDE CHANGE CASE P2**  
**LATERAL PANEL -Y**

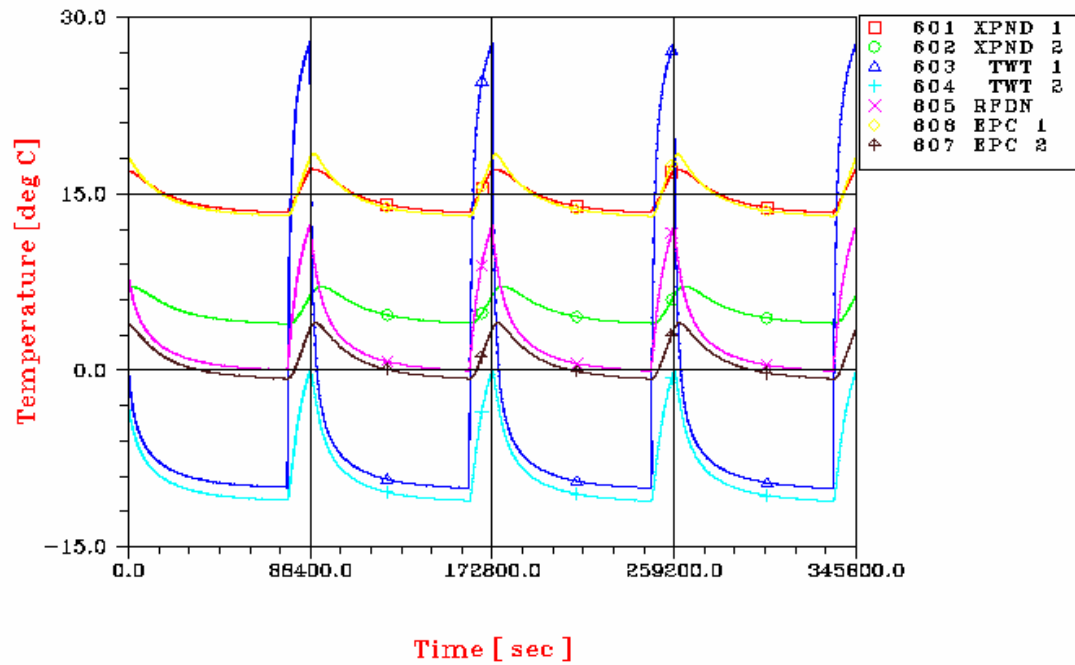

Figures 8.5-10 PLANCK - BOL attitude change -Y panel

**PLANCK ATTITUDE CHANGE CASE P2**

**LATERAL PANEL +Z-Y**

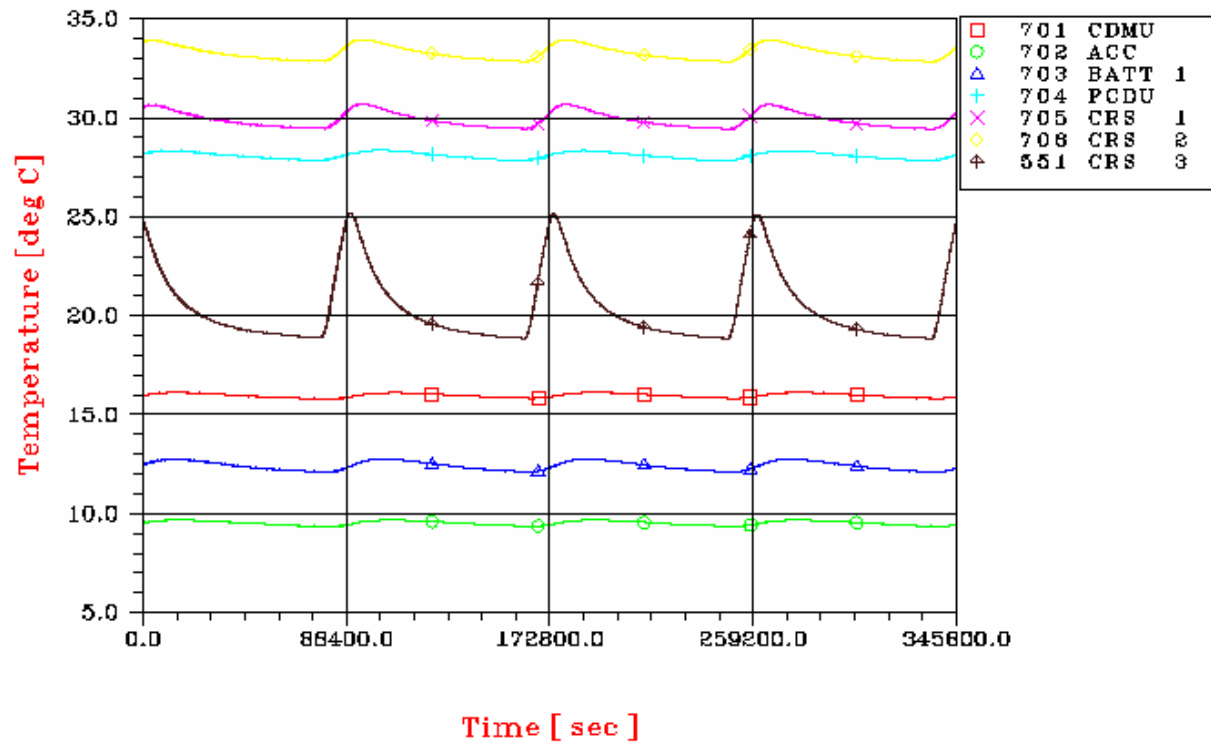

Figures 8.5-11 PLANCK - BOL attitude change -Y+Z panel

**PLANCK ATTITUDE CHANGE CASE P2**  
**SUBPLATFORM +X-X**

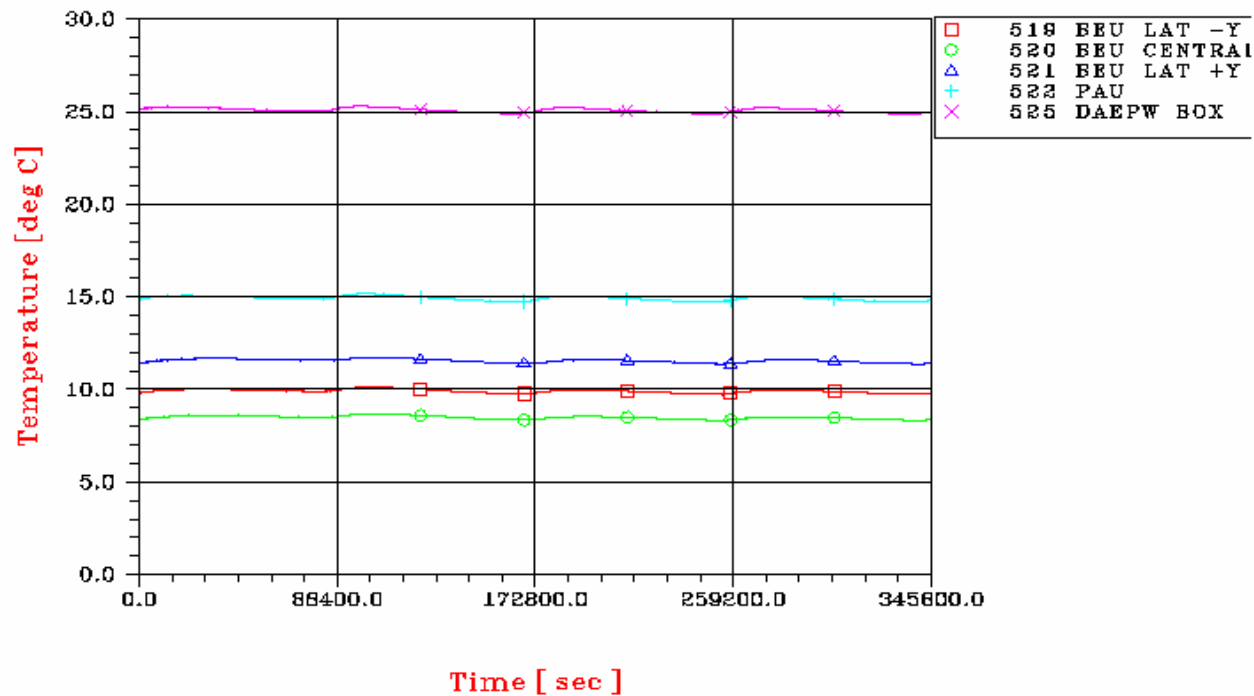

Figures 8.5-12 PLANCK - BOL attitude change subplatform panel

**PLANCK ATTITUDE CHANGE CASE P2**  
**HE TANK**

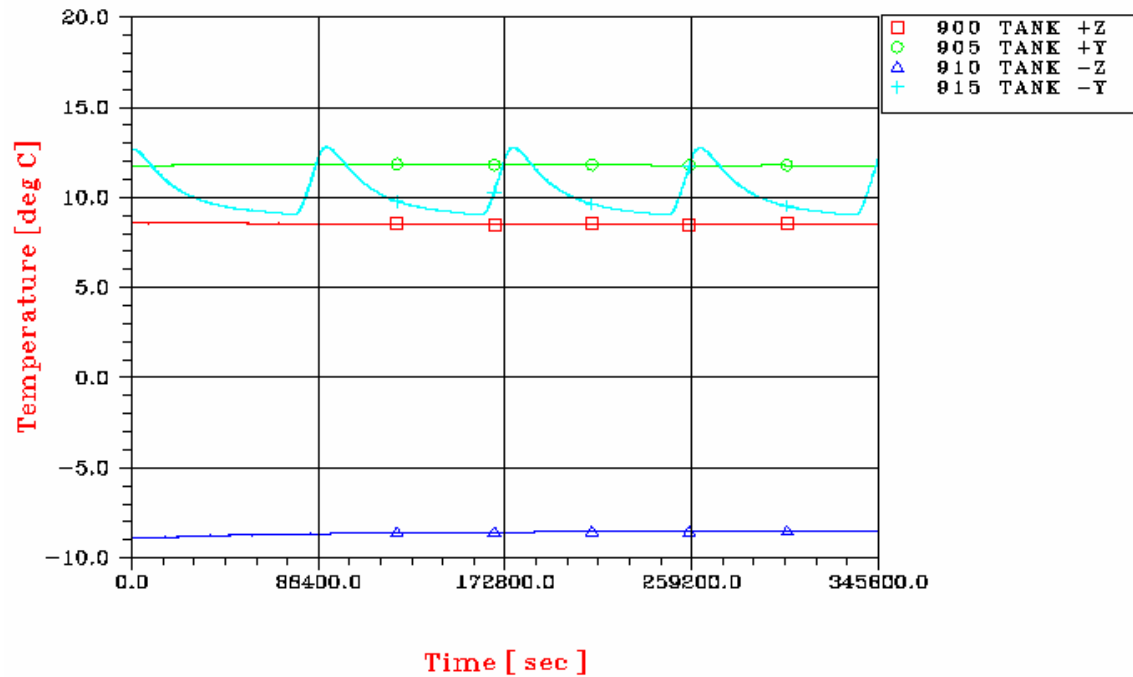

Figures 8.5-13 PLANCK - BOL attitude change Helium TANK

PLANCK ATTITUDE CHANGE CASE P2  
PROPELLANT TANK

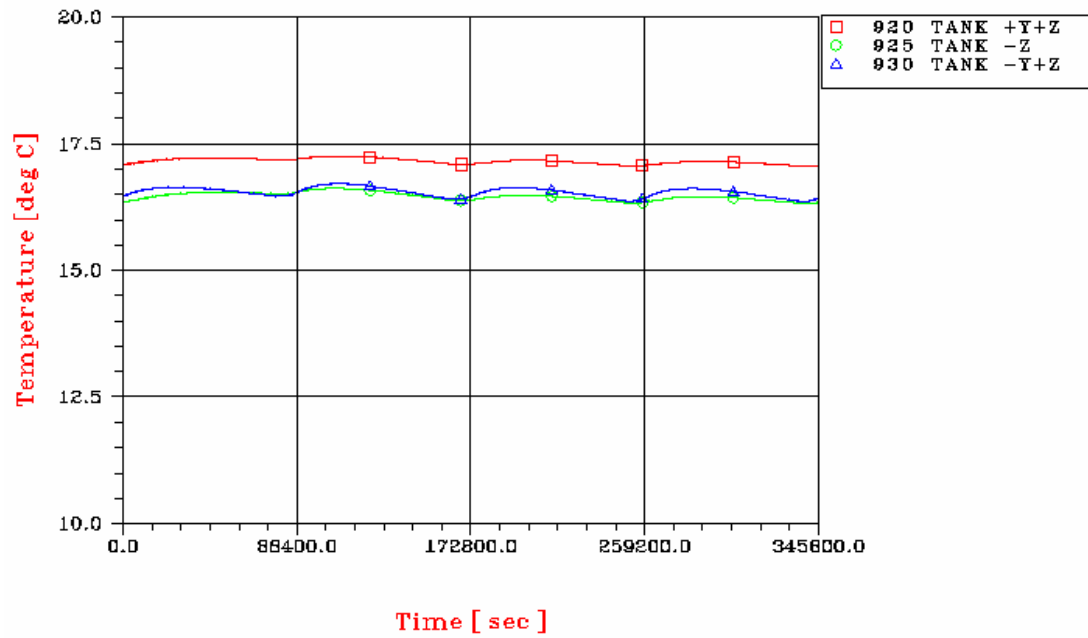

Figures 8.5-14 PLANCK - BOL attitude change Propellant TANK



**Alcatel Alenia Space Italia S.p.A.**

**DOC. No : H-P-RP-AI-0040**  
**ISSUE : 05**  
**DATE : 24/FEB/06**  
**PAGE : 311 of 341**  
**CLASS. : DC**  
**ANNEXES : ..... Pages....**

## 11.6 PLANCK: PLOTS OF TRANSIENT CASE Q1

In the following figures, the temperature plots of the transient analysis concerning the attitude change of the satellite in EOL condition and with the SCC1 operating are presented.

Change of attitude at time=86400s

PLANCK ATTITUDE CHANGE CASE Q1  
 LATERAL PANEL +Z

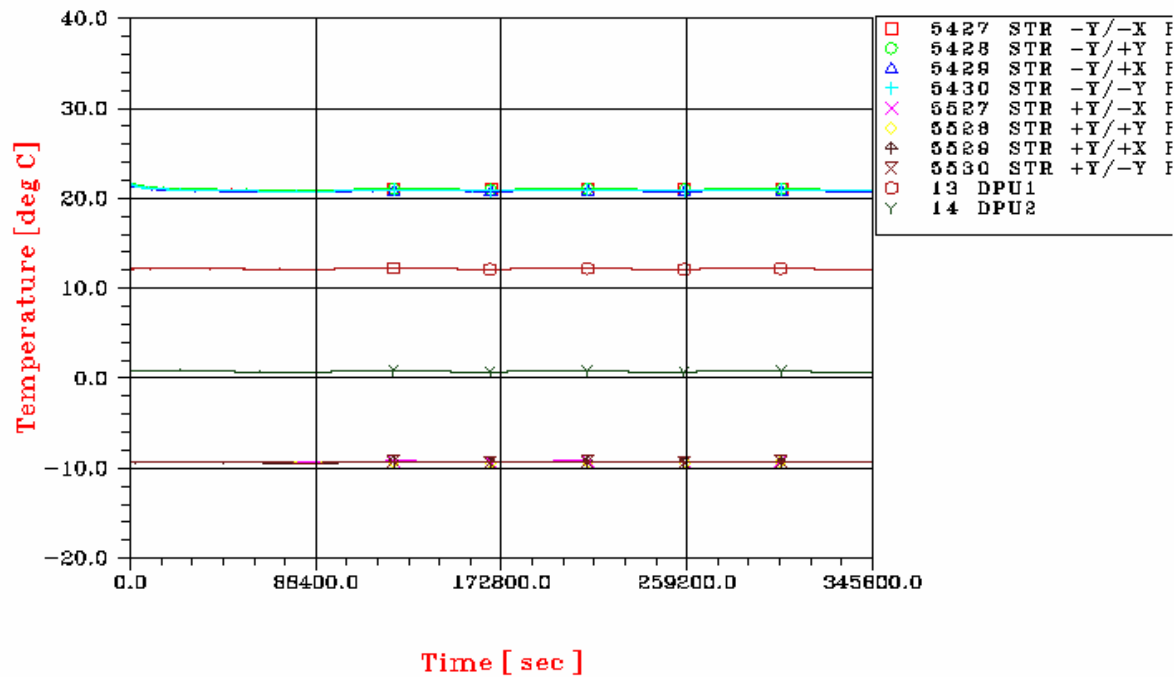

Figures 8.6-1 PLANCK - EOL attitude change +Z panel



**PLANCK ATTITUDE CHANGE CASE Q1**  
**LATERAL PANEL +Z+Y**

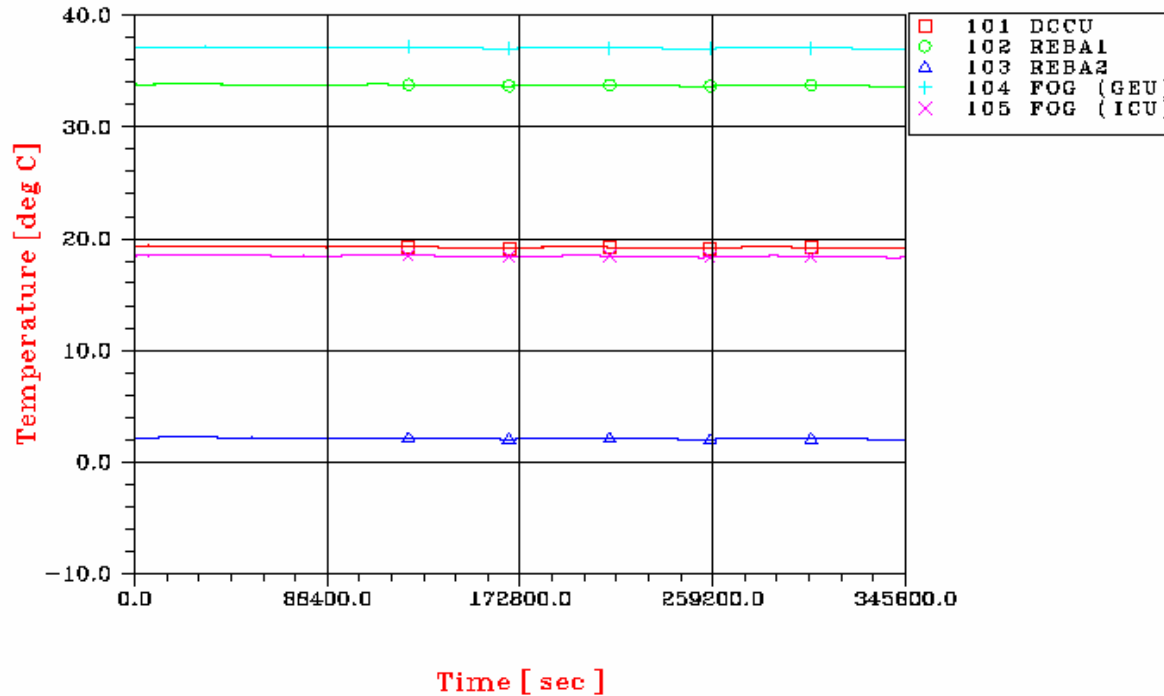

Figures 8.6-2 PLANCK - EOL attitude change +Y+Z panel

**PLANCK ATTITUDE CHANGE CASE Q1**  
**LATERAL PANEL +Y**

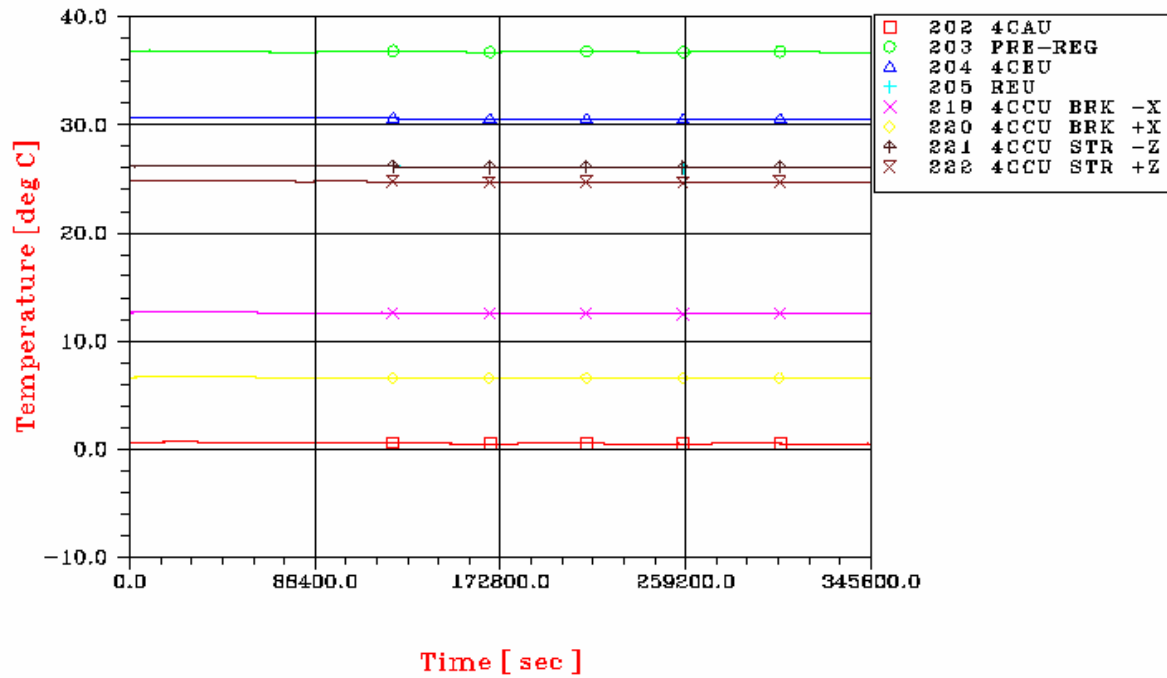

Figures 8.6-3 PLANCK - EOL attitude change +Y panel

### PLANCK ATTITUDE CHANGE CASE Q1

SCC1 ON

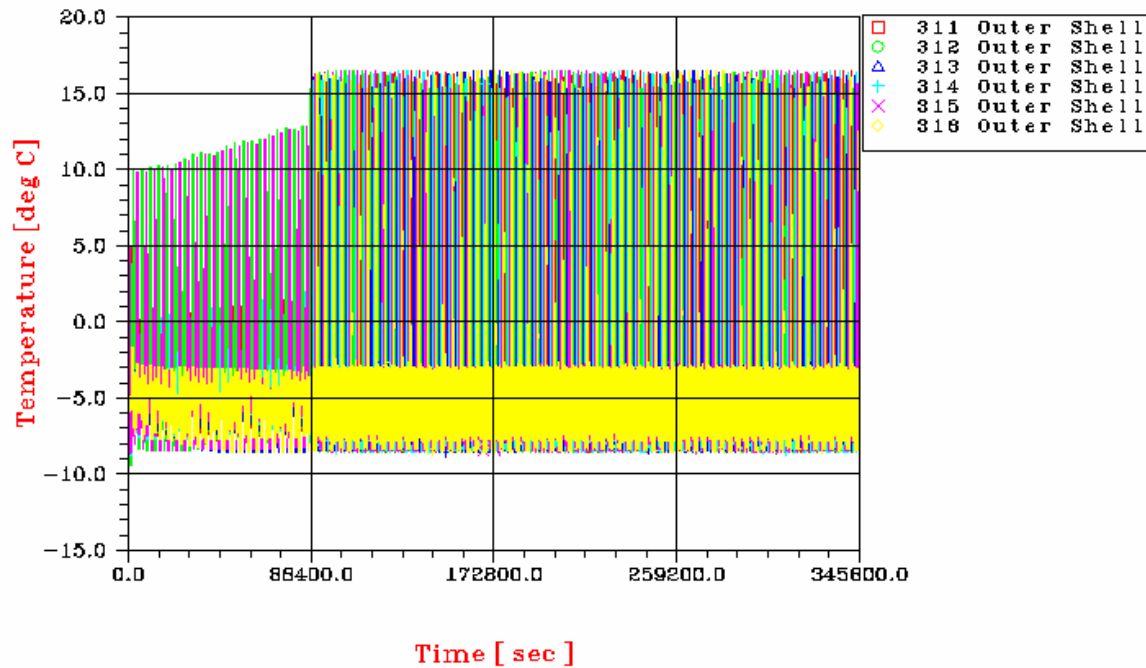

Figures 8.6-4 PLANCK - EOL attitude change +Y-Z panel

## PLANCK ATTITUDE CHANGE CASE Q1

SCC1 ON

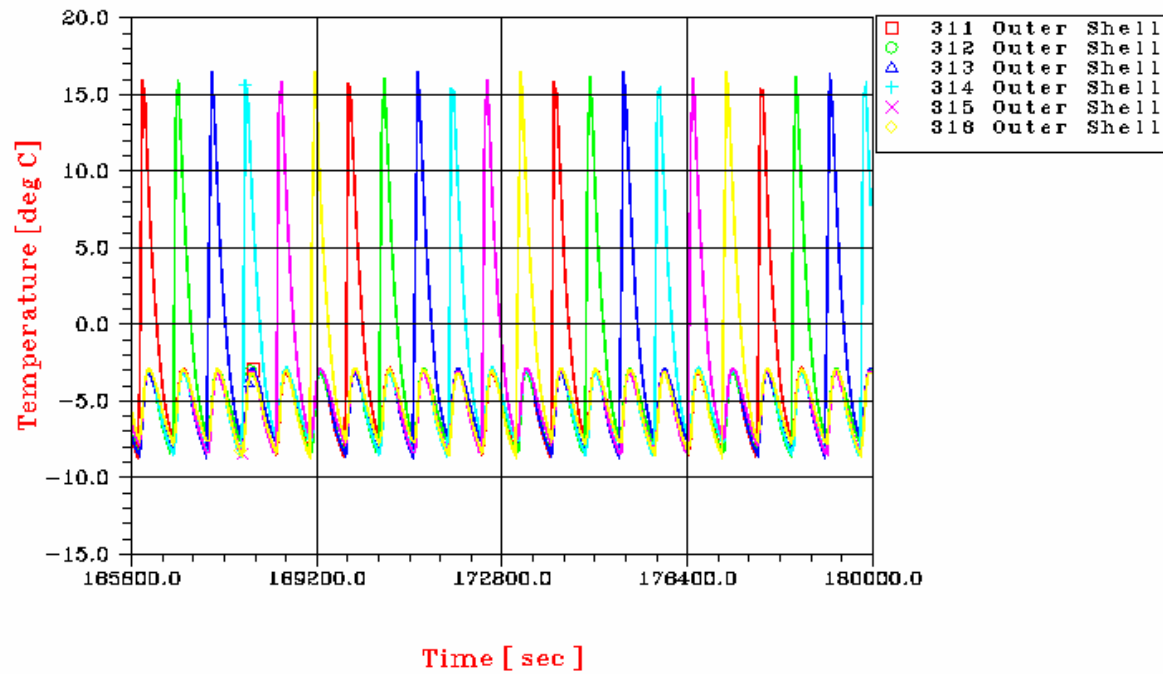

Figures 8.6-5 PLANCK - EOL attitude change +Y-Z panel

PLANCK ATTITUDE CHANGE CASE Q1

SCC1

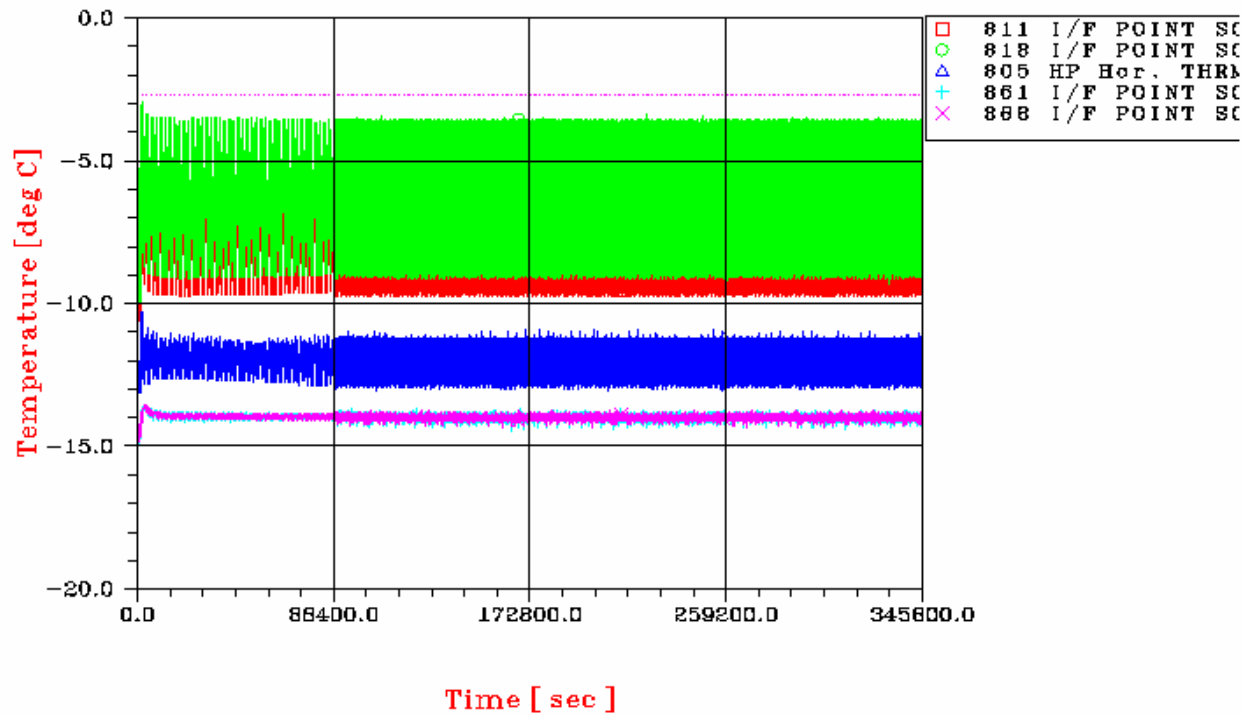

Figures 8.6-6 PLANCK - EOL attitude change SCC I/F temperatures

PLANCK ATTITUDE CHANGE CASE Q1

SCC1

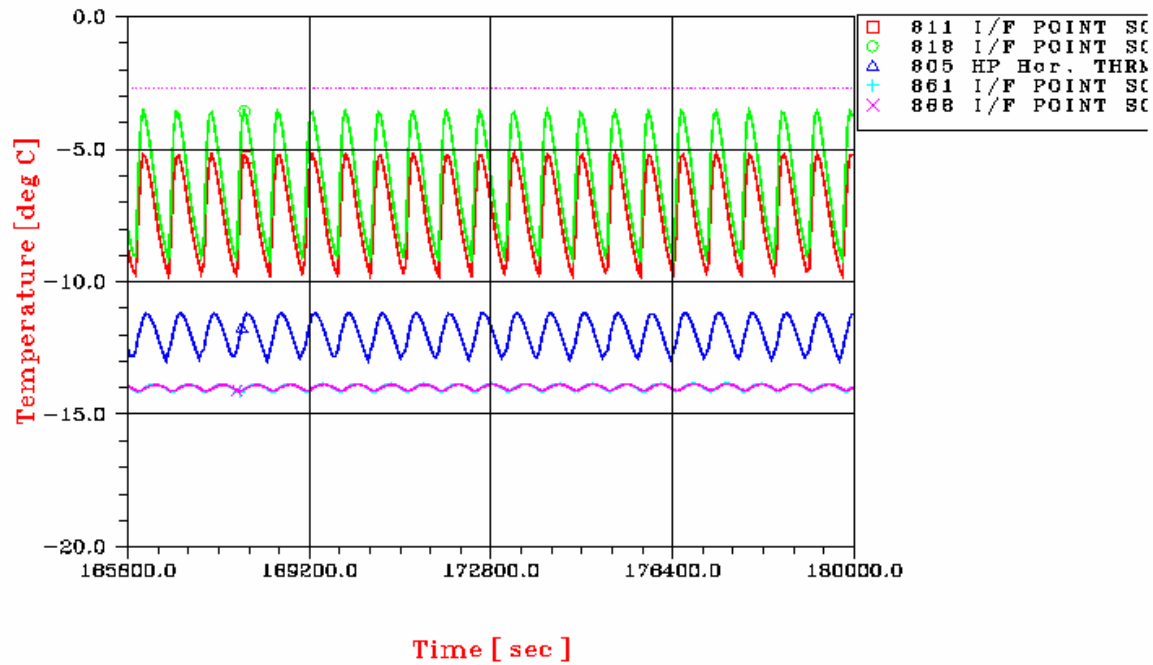

Figures 8.6-7 PLANCK - EOL attitude change SCC I/F temperatures

## PLANCK ATTITUDE CHANGE CASE Q1

### LATERAL PANEL -Z

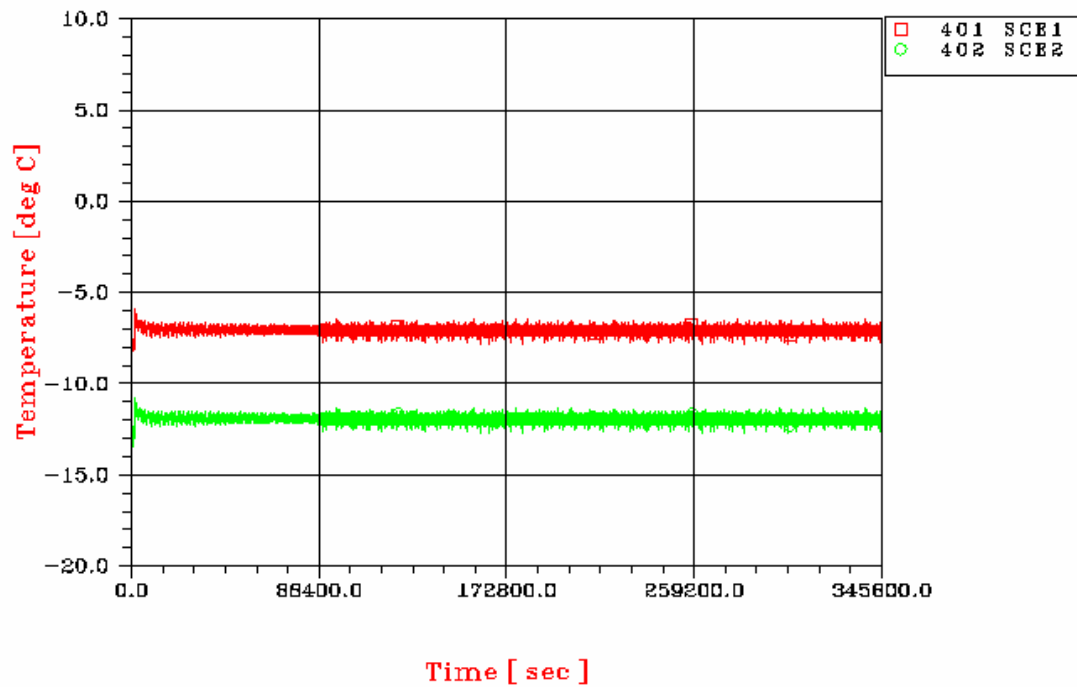

Figures 8.6-8 PLANCK - EOL attitude change -Z panel

PLANCK ATTITUDE CHANGE CASE Q1

SCC2 OFF

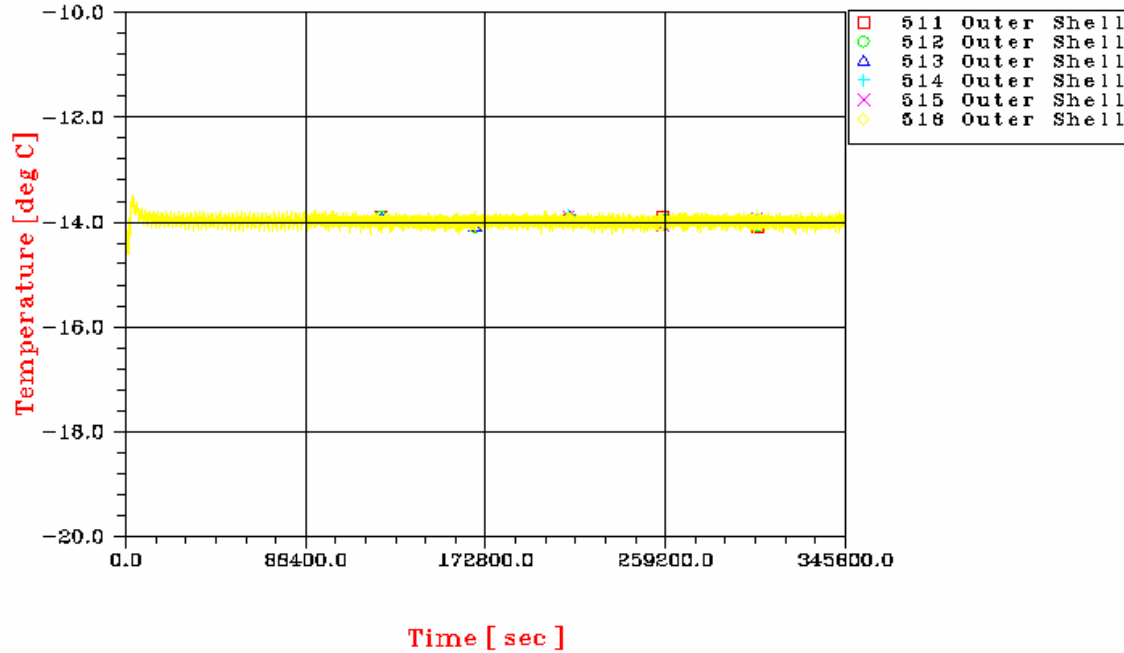

Figures 8.6-9 PLANCK - EOL attitude change -Y-Z panel



**PLANCK ATTITUDE CHANGE CASE Q1**  
**LATERAL PANEL -Y**

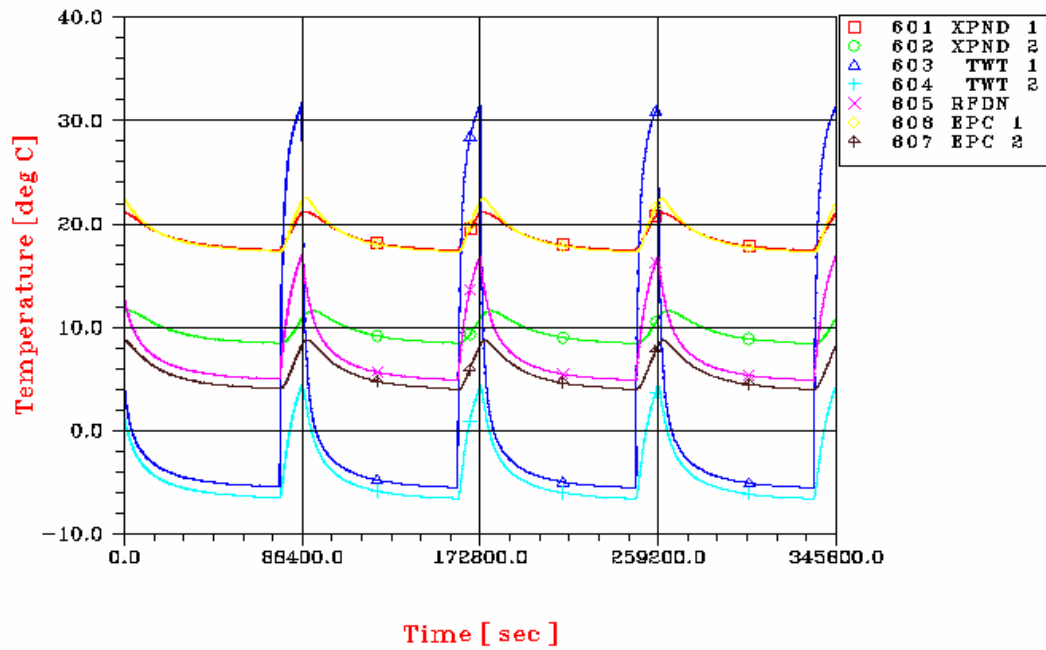

Figures 8.6-10 PLANCK - EOL attitude change -Y panel

**PLANCK ATTITUDE CHANGE CASE Q1**  
**LATERAL PANEL +Z-Y**

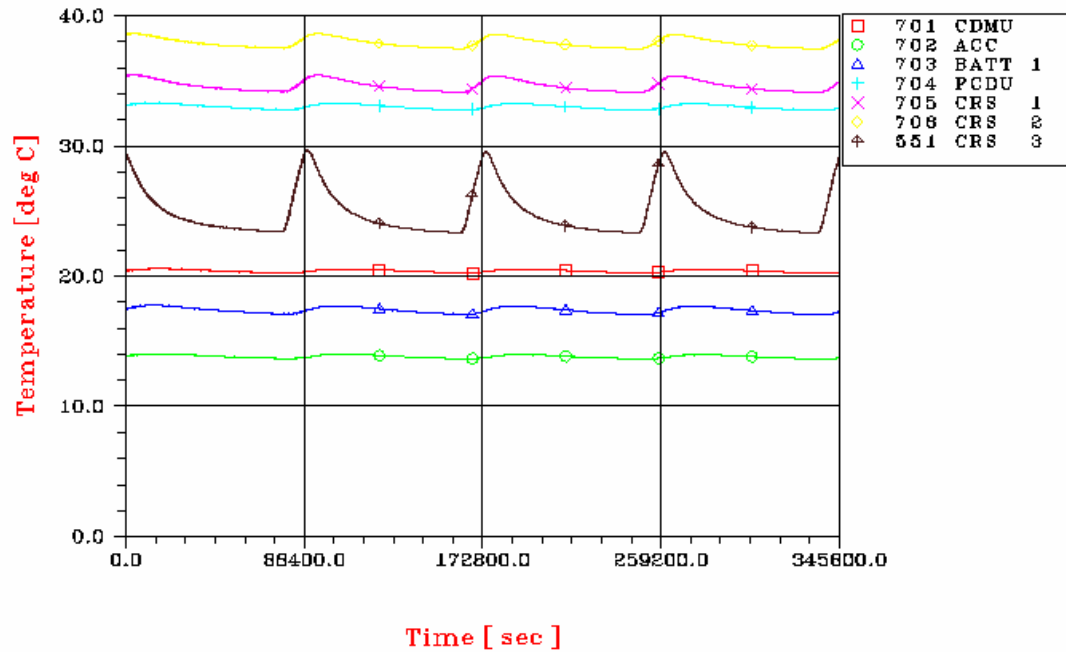

Figures 8.6-11 PLANCK - EOL attitude change -Y+Z panel

PLANCK ATTITUDE CHANGE CASE Q1  
 SUBPLATFORM +X-X

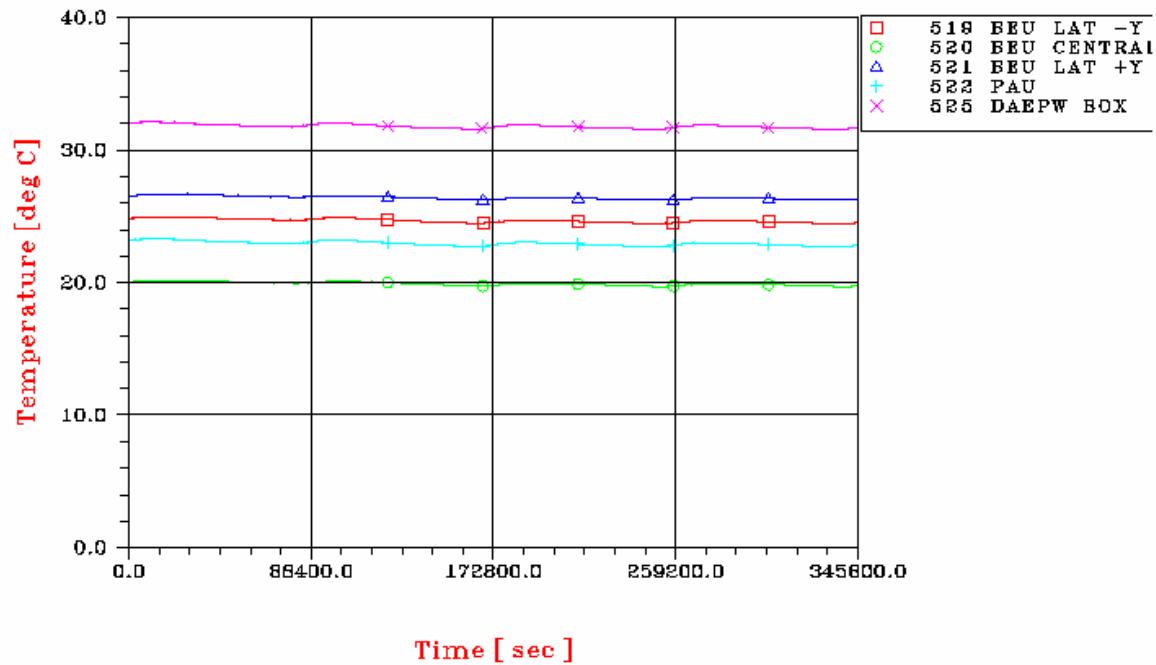

Figures 8.6-12 PLANCK - EOL attitude change subplatform panel

PLANCK ATTITUDE CHANGE CASE Q1  
PROPELLANT TANK

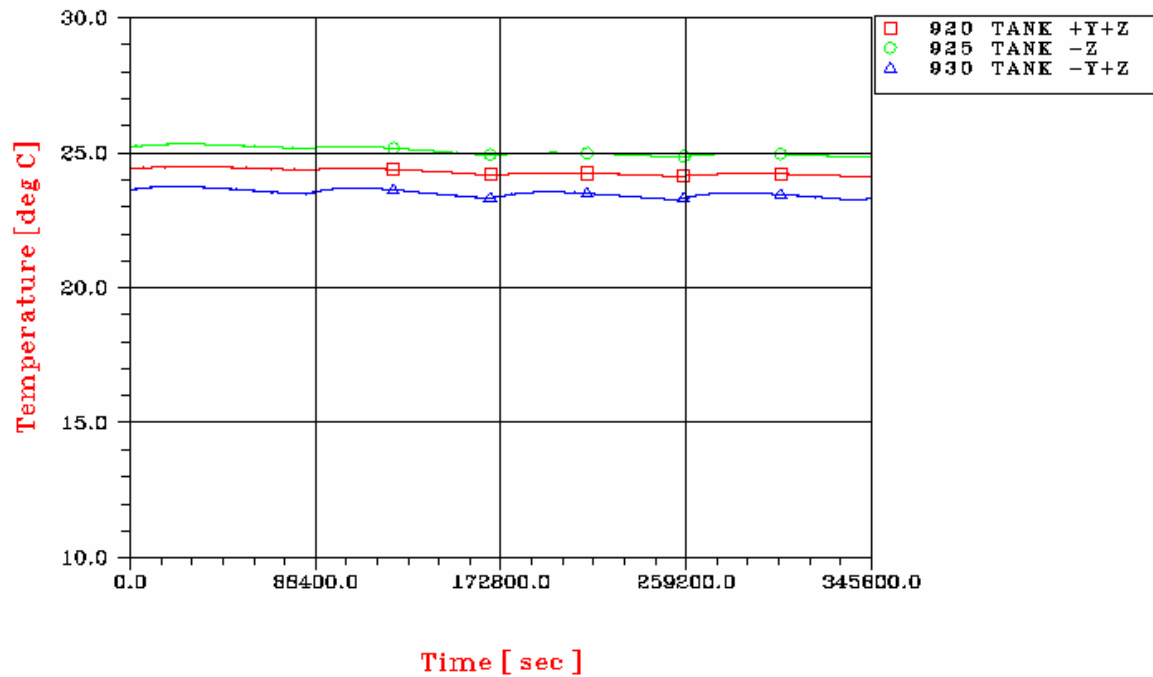

Figures 8.6-13 PLANCK - EOL attitude change propellant Tank

PLANCK ATTITUDE CHANGE CASE Q1  
 HE TANK

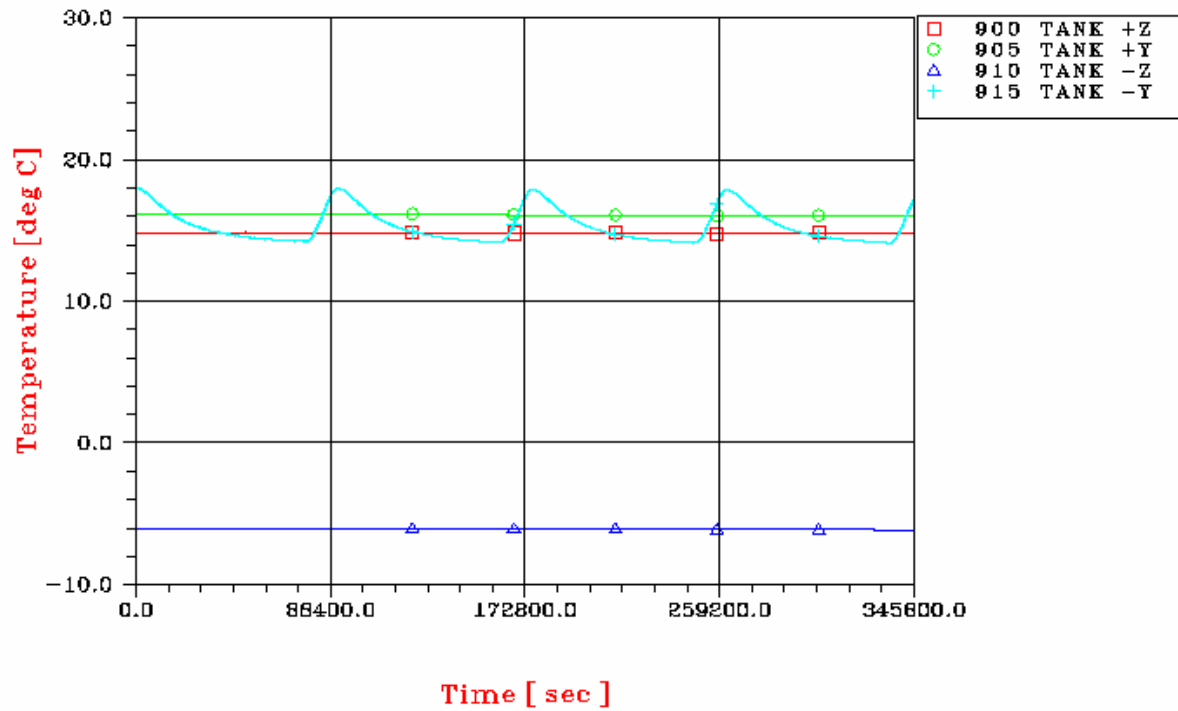

Figures 8.6-14 PLANCK - EOL attitude change He Tank



**Alcatel Alenia Space Italia S.p.A.**

**DOC. No : H-P-RP-AI-0040**  
**ISSUE : 05**  
**DATE : 24/FEB/06**  
**PAGE : 326 of 341**  
**CLASS. : DC**  
**ANNEXES : ..... Pages....**

### 11.7 PLANCK: PLOTS OF TRANSIENT CASE Q2

In the following figures, the temperature plots of the transient analysis concerning the attitude change of the satellite in EOL condition and with the SCC2 operating are presented.

Change of attitude at time=86400s

**PLANCK ATTITUDE CHANGE CASE Q2**  
**LATERAL PANEL +Z**

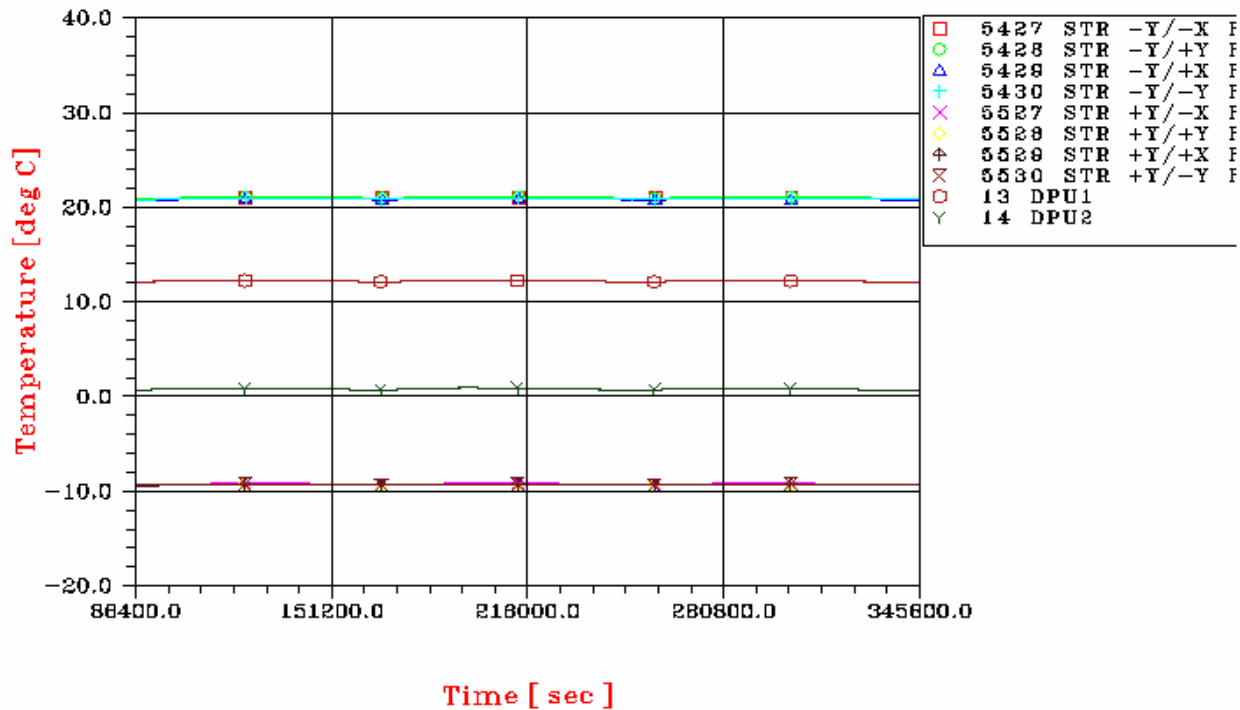

Figures 8.7-1 PLANCK - EOL attitude change +Z panel

PLANCK ATTITUDE CHANGE CASE Q2  
 LATERAL PANEL +Z+Y

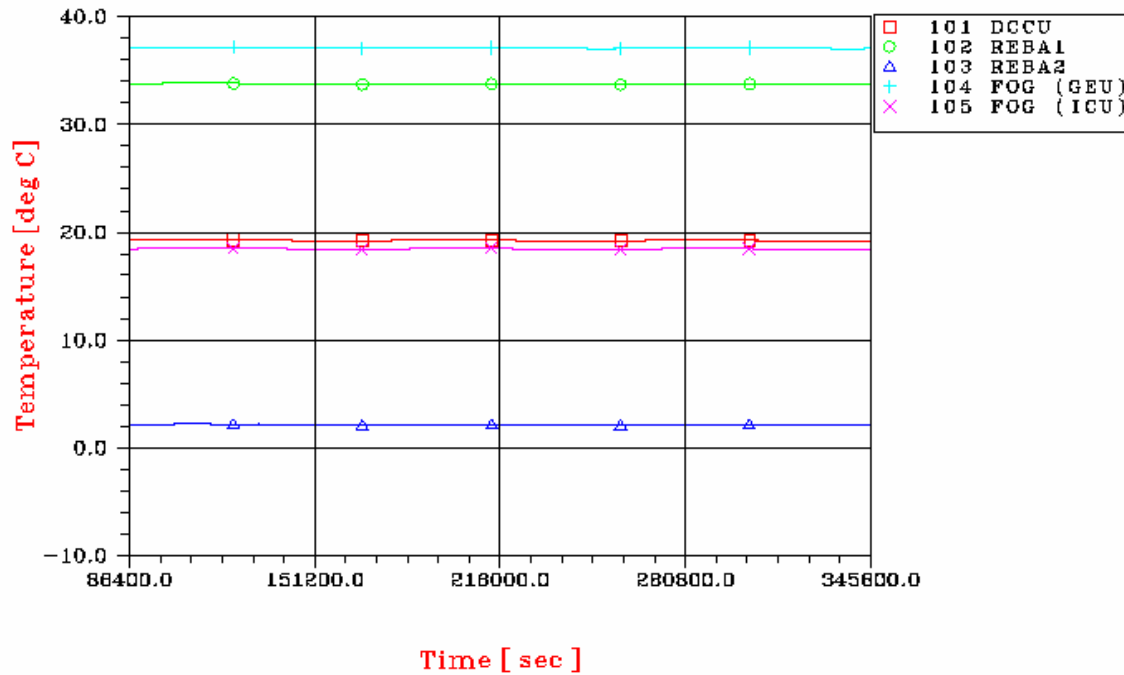

Figures 8.7-2 PLANCK - EOL attitude change +Y+Z panel



**PLANCK ATTITUDE CHANGE CASE Q2**  
**LATERAL PANEL +Y**

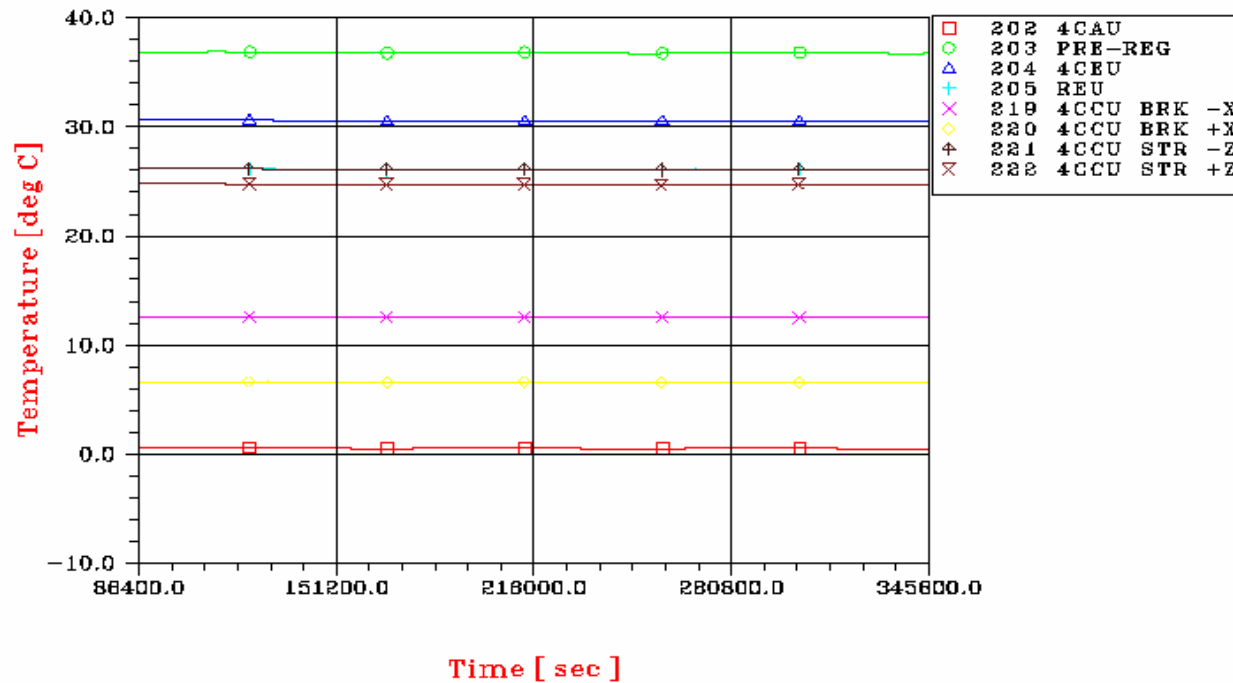

Figures 8.7-3 PLANCK - EOL attitude change +Y panel

## PLANCK ATTITUDE CHANGE CASE Q2

SCC1 ON

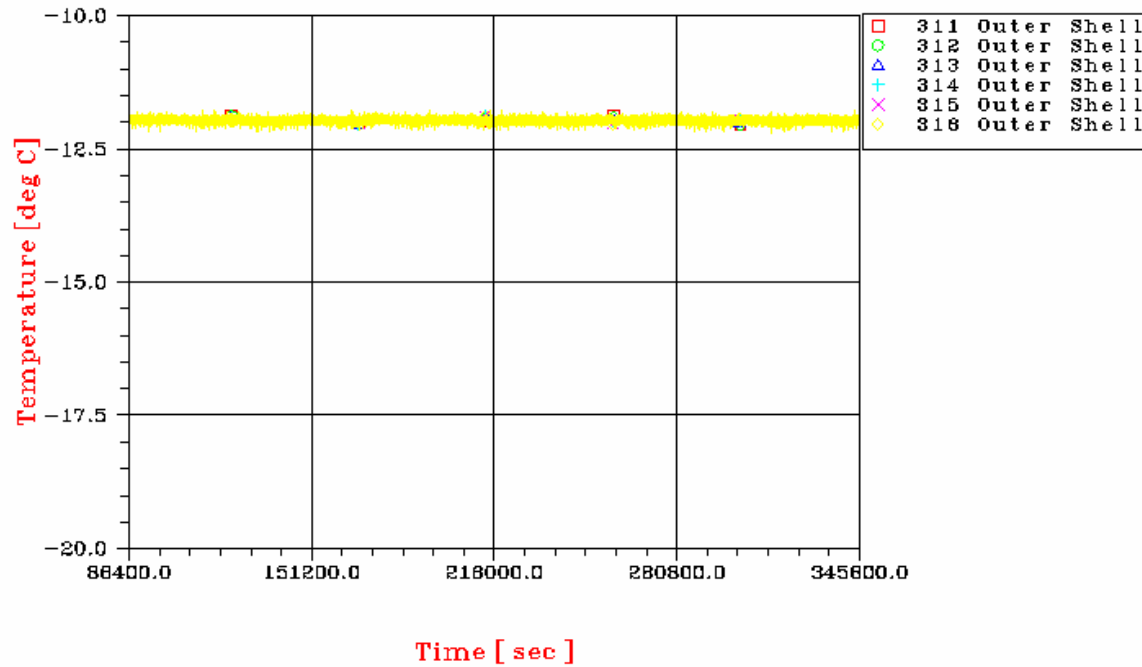

Figures 8.7-4 PLANCK - EOL attitude change +Y-Z panel

### PLANCK ATTITUDE CHANGE CASE Q2

#### SCC1

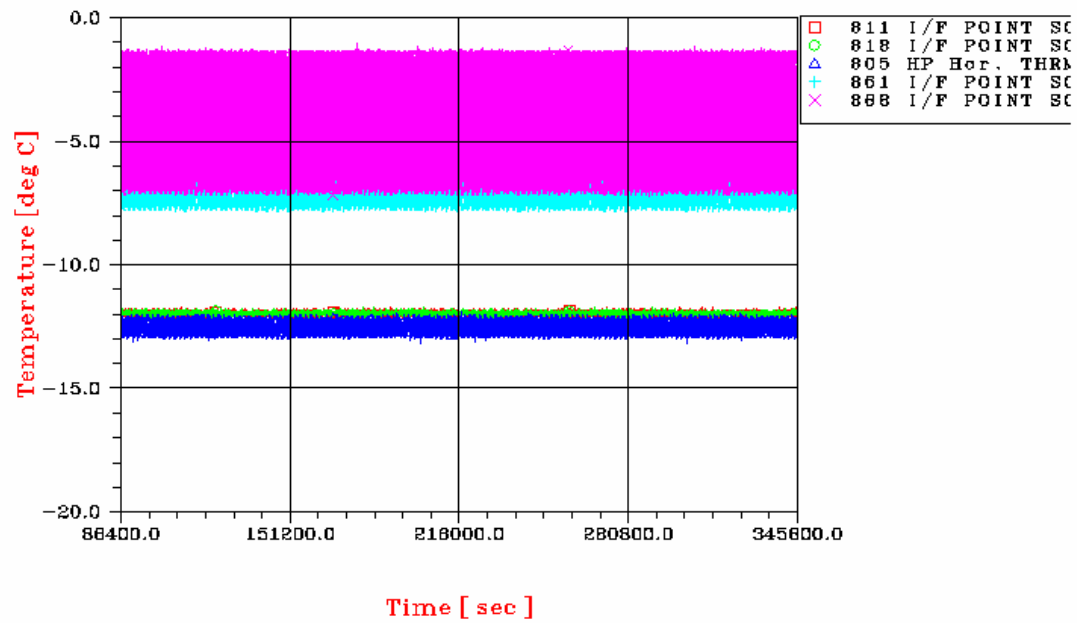

Figures 8.7-5 PLANCK - EOL attitude change SCC I/F temperatures

PLANCK ATTITUDE CHANGE CASE Q2

SCC1

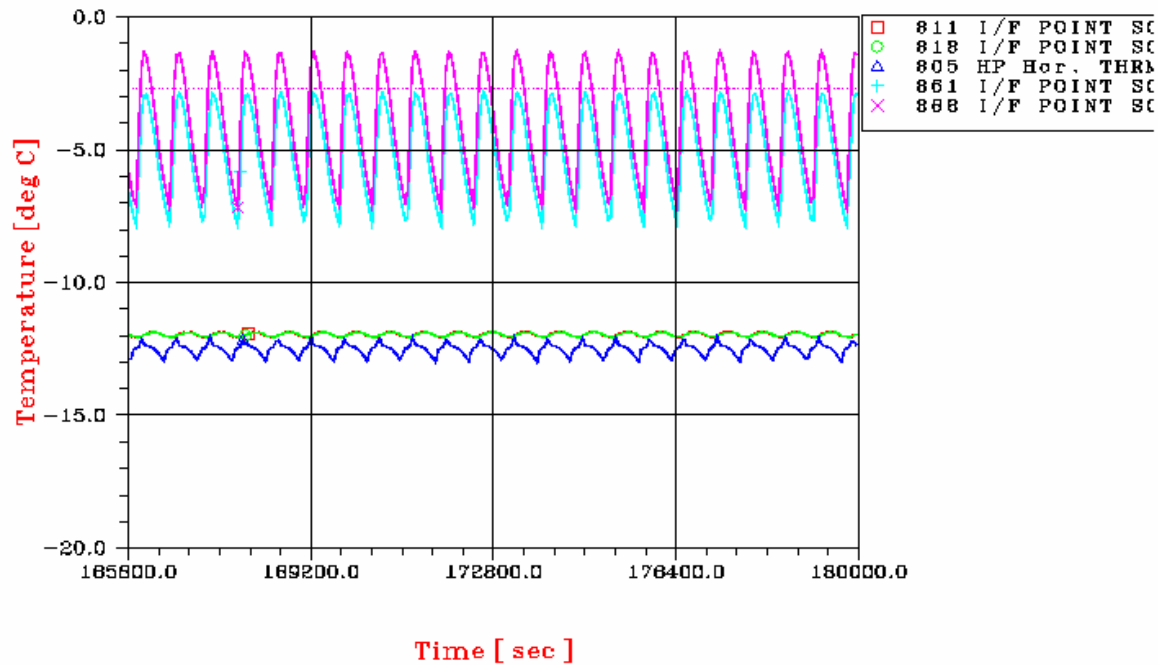

Figures 8.7-6 PLANCK - EOL attitude change SCC I/F temperatures

## PLANCK ATTITUDE CHANGE CASE Q2

### LATERAL PANEL -Z

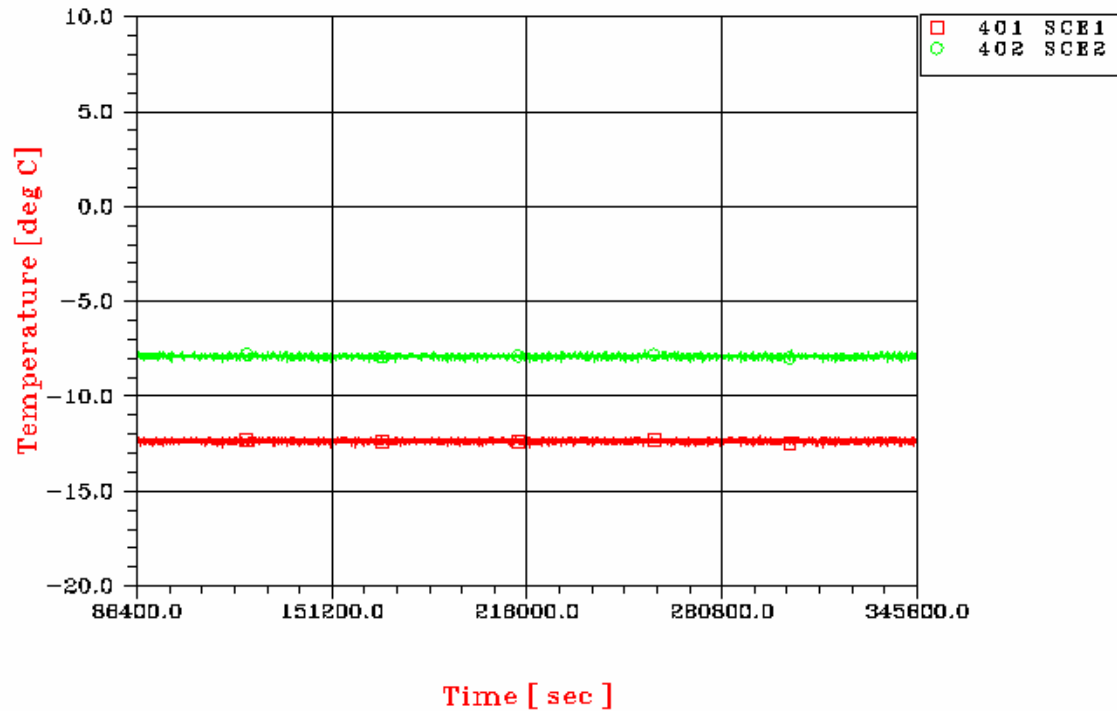

Figures 8.7-7 PLANCK - EOL attitude change -Z panel

PLANCK ATTITUDE CHANGE CASE Q2

SCC2

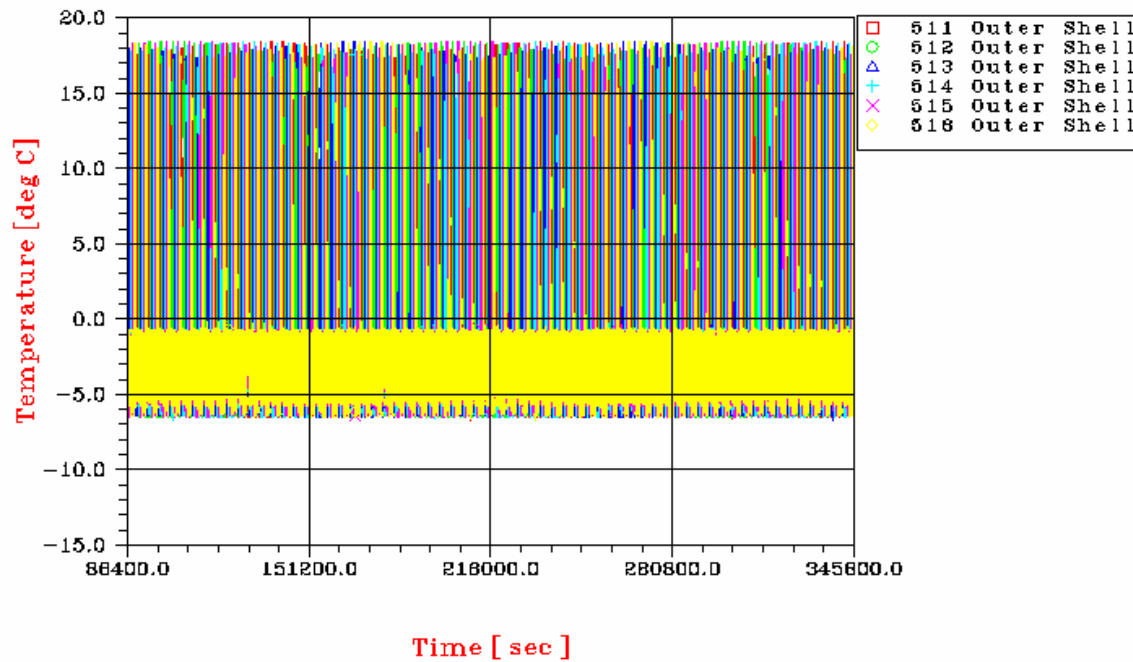

Figures 8.7-8 PLANCK - EOL attitude change -Y-Z panel

## PLANCK ATTITUDE CHANGE CASE Q2

SCC2

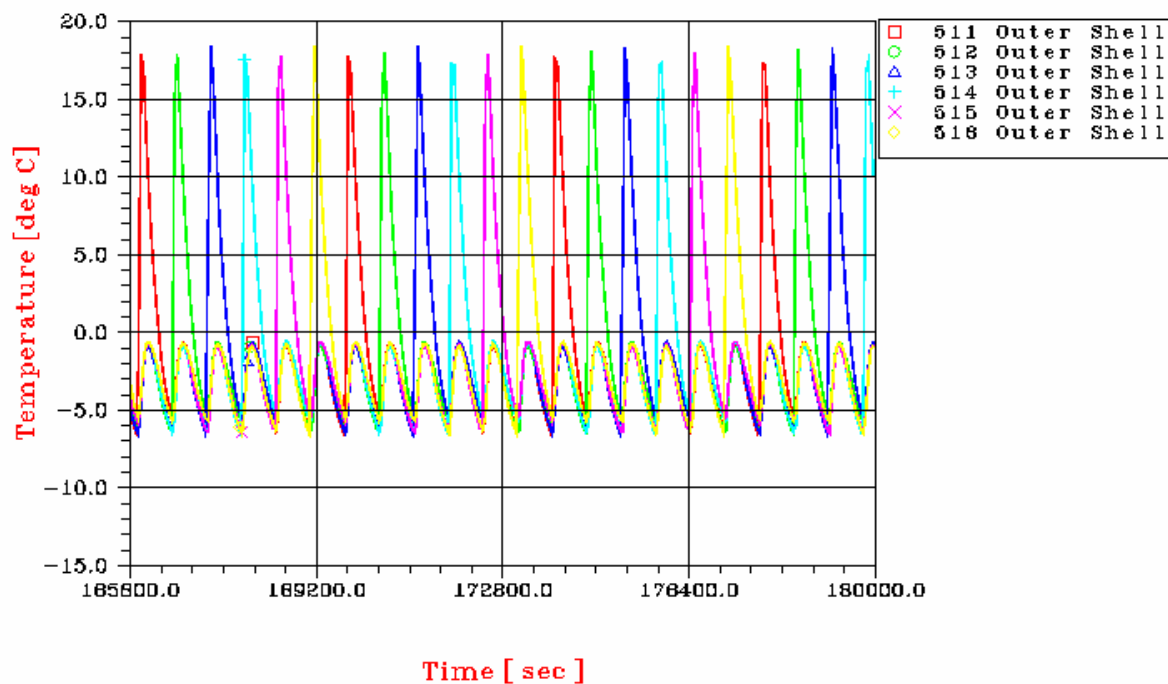

Figures 8.7-9 PLANCK - EOL attitude change -Y-Z panel

PLANCK ATTITUDE CHANGE CASE Q2  
 LATERAL PANEL -Y

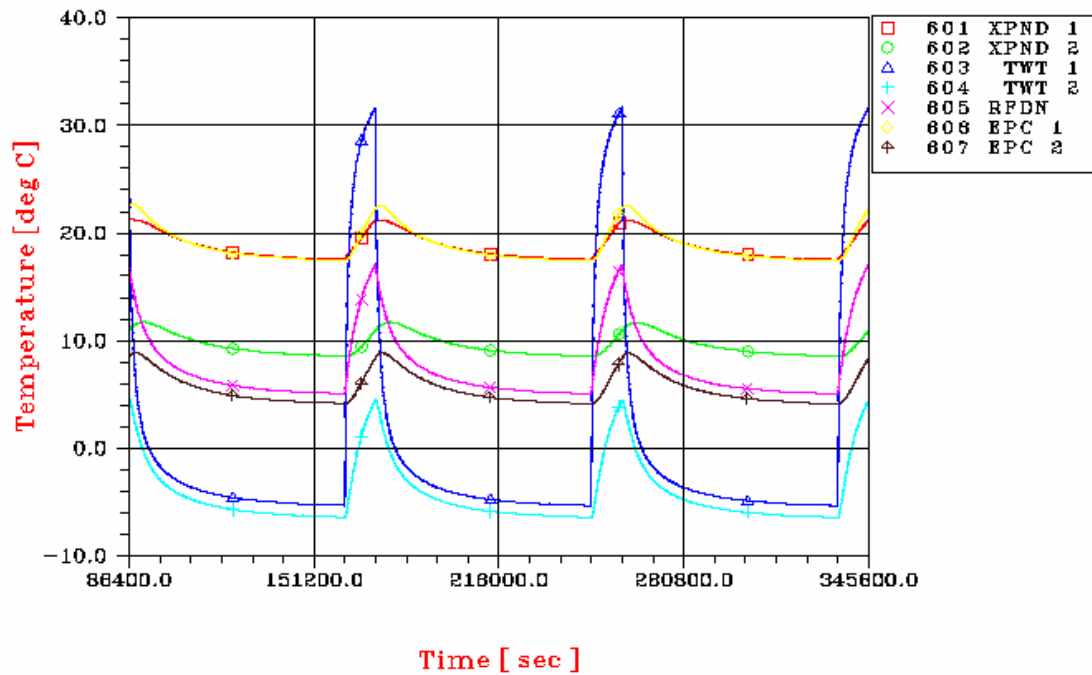

Figures 8.7-10 PLANCK - EOL attitude change -Y panel



PLANCK ATTITUDE CHANGE CASE Q2

LATERAL PANEL +Z-Y

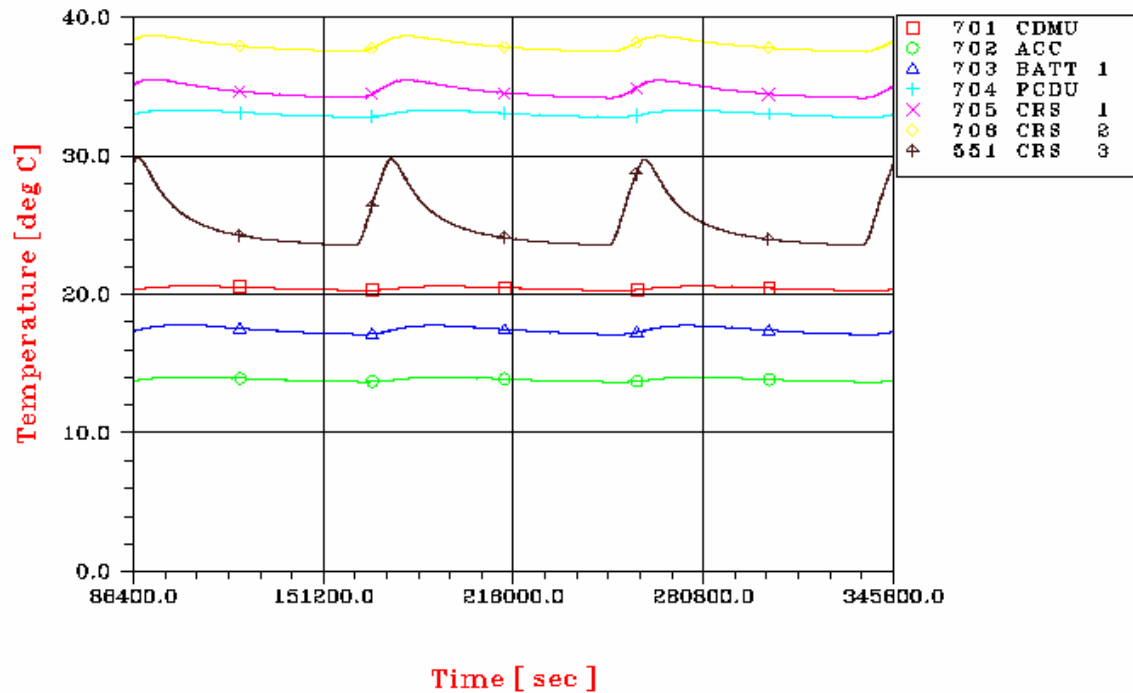

Figures 8.7-11 PLANCK - EOL attitude change -Y+Z panel

**PLANCK ATTITUDE CHANGE CASE Q2**  
**SUBPLATFORM +X-X**

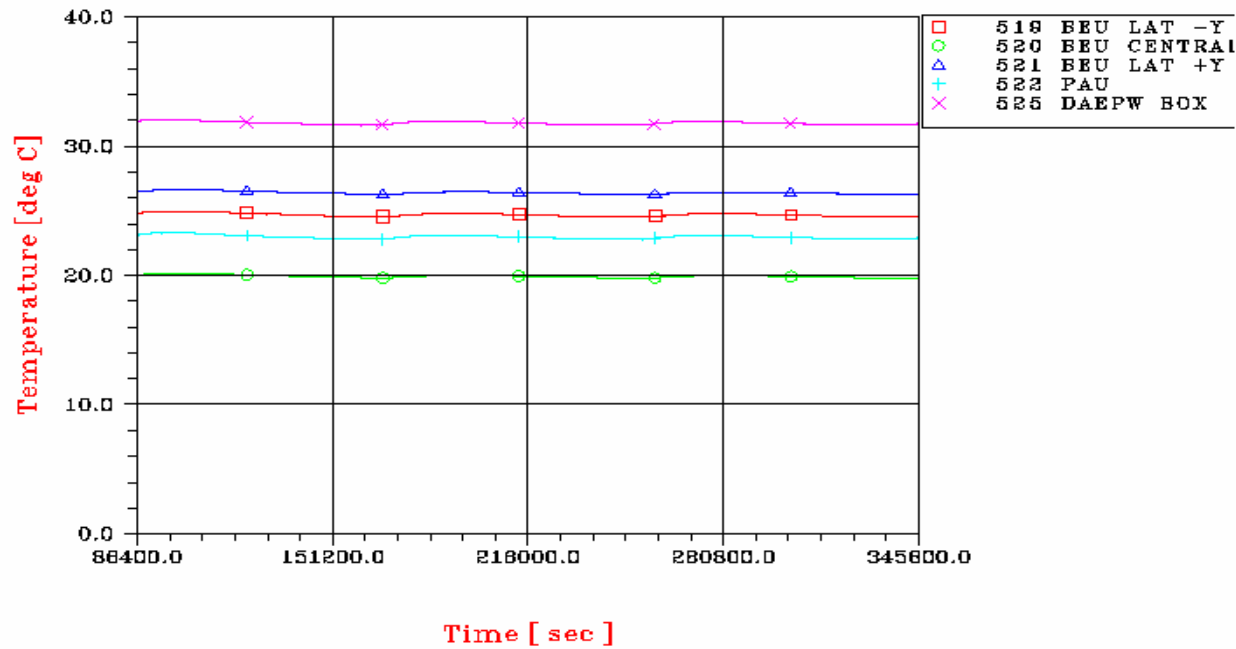

Figures 8.7-12 PLANCK - EOL attitude change subplatform panel

PLANCK ATTITUDE CHANGE CASE Q2  
PROPELLANT TANK

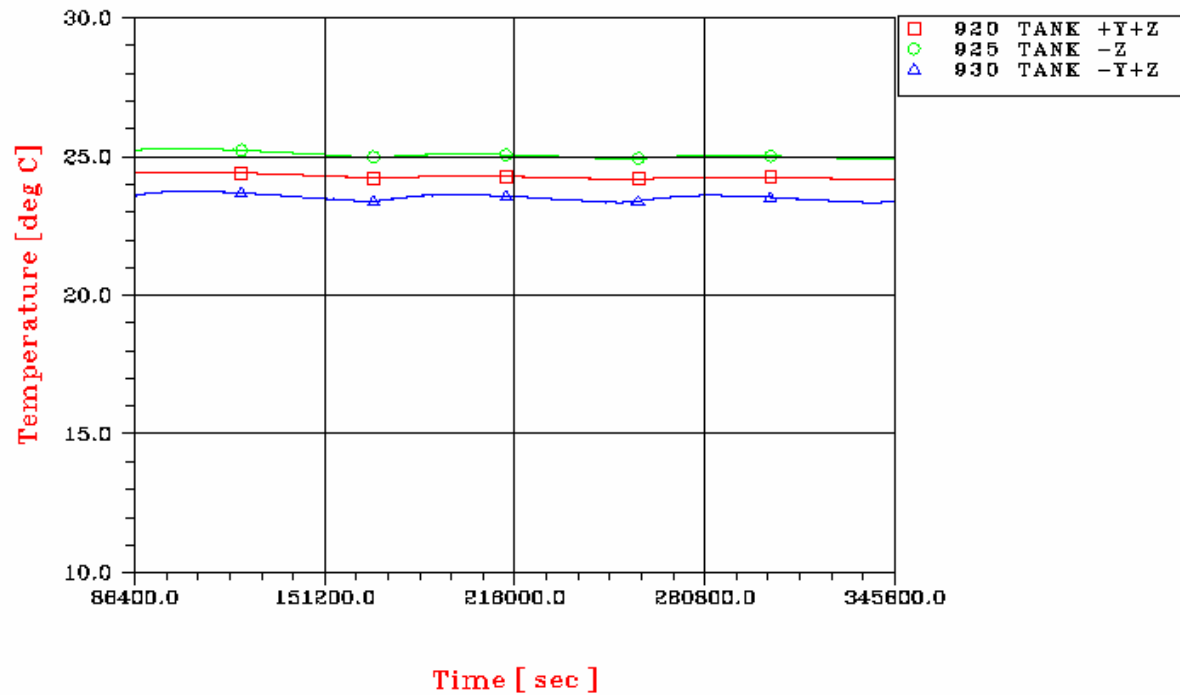

Figures 8.7-13 PLANCK - EOL attitude change propellant Tank

PLANCK ATTITUDE CHANGE CASE Q2  
HE TANK

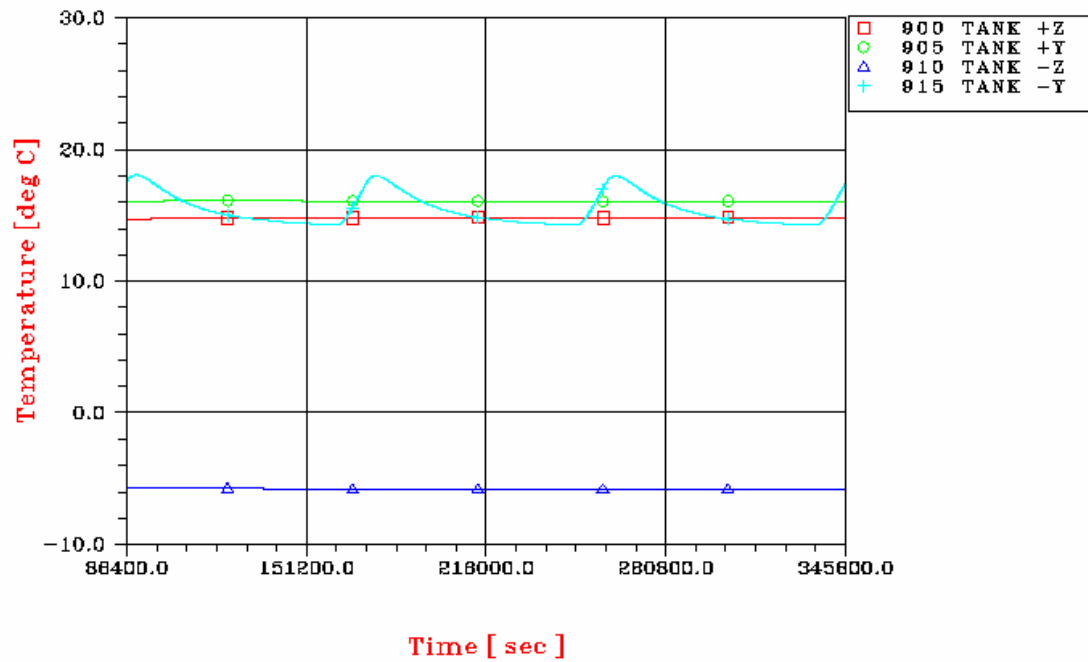

Figures 8.7-14 PLANCK - EOL attitude change He Tank

