



HERSCHEL / PLANCK

**Test specification for Herschel
Instruments AVM and FM tests
performed at satellite level.
H-P-2-ASP-TS-1083**

Rédigé par/ <i>Written by</i>	Responsabilité-Service-Société <i>Responsibility-Office -Company</i>	Date	Signature
B.Collaudin	Instruments Interfaces	5/10/06	
Vérifié par/<i>Verified by</i>			
P.Couzin	Electrical Engineering	17/10/06	
B.Gobillot	AIV manager	05.10.06	
Y.Roche	System Engineer	05.05.06	
D.Montet	Herschel Manager	05.10.06	
Th.Grassin	PA Manager	09.10.06	
Approbation/<i>Approved</i>			
J.M.Reix	Project Manager	10.10.06	

Entité Emettrice : Alcatel Alenia Space - France
(détentrice de l'original) :



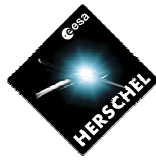

ENREGISTREMENT DES EVOLUTIONS / CHANGE RECORDS

ISSUE	DATE	§ : DESCRIPTION DES EVOLUTIONS § : CHANGE RECORD	REDACTEUR AUTHOR
1_draff <u>1.0</u>	8/9/06 <u>29/09/06</u>	Initial issue <u>After review by all parties. See details next page</u>	B.Collaudin <u>B.Collaudin</u>



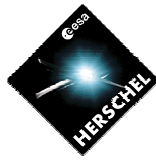
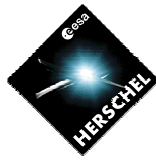
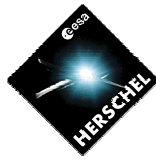

TABLE OF CONTENTS

TABLE OF CONTENTS	<u>6</u>
To do list	<u>8</u>
1. TEST OBJECTIVE.....	<u>9</u>
1.1 Introduction.....	<u>9</u>
1.2 Test objectives.....	<u>9</u>
1.2.1 Herschel FM Satellite/AVM Test Programme General Objectives	<u>9</u>
1.2.2 Instrument Specific Test Definitions and Objectives	<u>9</u>
2. DOCUMENTS	<u>11</u>
2.1 Applicable documents	<u>11</u>
2.2 Reference documents.....	<u>12</u>
2.3 Acronyms.....	<u>13</u>
3. TEST SPECIMEN DEFINITION	<u>13</u>
3.1 Instruments Configurations for AVM & FM tests.....	<u>14</u>
3.1.1 HIFI:	<u>14</u>
3.1.2 SPIRE	<u>15</u>
3.1.3 PACS.....	<u>15</u>
3.2 EGSE Configurations for AVM & FM tests.....	<u>16</u>
3.2.1 Satellite EGSE configuration	<u>16</u>
3.2.2 Instruments EGSE	<u>16</u>
3.3 Instruments database configuration.....	<u>18</u>
3.4 Instruments software configuration.....	<u>18</u>
3.5 Cryostat Configuration for IST and TV test.	<u>18</u>
3.5.1 Cryostat Operation during IST:.....	<u>19</u>
3.5.2 Cryostat Operation during TV/TB test:	<u>20</u>
3.5.3 Cryostat Operation during EMC tests:.....	<u>21</u>
4. TEST DEFINITION.....	<u>22</u>
4.1 Overview of Herschel AVM & FM tests sequence	<u>22</u>
4.2 Time Allocation for instruments tests.....	<u>25</u>
4.3 Incoming Inspection	<u>26</u>
4.4 Instruments WU Integration tests & UFT (Unit Functional Test).....	<u>26</u>
4.4.1 Integration tests.....	<u>27</u>
4.4.2 Instruments full software image patch with OBSM	<u>27</u>
4.4.3 UFT's:	<u>28</u>
4.5 SFT (Short Functional tests)	<u>31</u>



4.5.1	PACS SFT	<u>31</u>
4.5.2	SPIRE SFT	<u>32</u>
4.5.3	HIFI SFT	<u>33</u>
4.6	<i>IST (Integrated System Test)</i>	<u>33</u>
4.6.1	IST overall description	<u>33</u>
4.6.2	PACS IST	<u>37</u>
4.6.3	SPIRE IST	<u>39</u>
4.6.4	HIFI IST	<u>43</u>
4.6.5	PACS-SPIRE parallel mode during IST/Commissioning	<u>45</u>
4.6.6	Additional instruments tests during IST	<u>46</u>
4.7	<i>TV/TB test</i>	<u>62</u>
4.7.1	PACS TV Test	<u>62</u>
4.7.2	SPIRE TV Test	<u>64</u>
4.7.3	HIFI TV test	<u>65</u>
4.7.4	SPIRE/PACS parallel TV test	<u>66</u>
4.8	<i>EMC test</i>	<u>67</u>
4.8.1	PACS EMC Test	<u>68</u>
4.8.2	SPIRE EMC Test	<u>69</u>
4.8.3	HIFI EMC test	<u>70</u>
5.	SUCCESS CRITERIA	<u>70</u>
5.1	<i>"out of limit" and TC checking</i>	<u>70</u>
5.1.1	BASIC Principle	<u>70</u>
5.1.2	"soft" and "hard" limits	<u>71</u>
6.	ORGANISATION & RESPONSABILITIES	<u>72</u>
6.1	<i>Organisation</i>	<u>72</u>
6.2	<i>Test organisation</i>	<u>72</u>
6.3	<i>Responsibilities</i>	<u>73</u>
6.4	<i>Tasks distribution</i>	<u>74</u>
6.4.1	General Tasks breakdown	<u>74</u>
7.	DOCUMENTATION	<u>75</u>
7.1	<i>Documents required before the test</i>	<u>75</u>
7.2	<i>Data acquired during the test</i>	<u>75</u>
7.2.1	S/C housekeeping	<u>75</u>
7.2.2	Instrument housekeeping	<u>75</u>
7.3	<i>Documents issued after the test</i>	<u>76</u>
7.3.1	Test Reports	<u>76</u>
7.3.2	Evaluation reports	<u>76</u>
8.	ANNEXES	<u>77</u>



TO DO LIST

Input missing

- Incoming inspection for FM SPIRE & HIFI: Confirm if this should be done or not & prepare procedure.
- Description of RMS for HIFI
- Description of SPIRE procedures (what is behind the names)
- Specification to be written:
 - AD-23 – Herschel EMC test specification - H-P-2-ASP-TS-0819_2.0 . TBW (AAS-F)
 - AD-33 - Herschel Instruments FPU Integration – TBW (ASED)
 - AD-52 – PACS User Manual - TBW
 - AD-63 – SPIRE Post- shipment tests TBW
 - AD-64 - HIFI ICU AVM SFT – TBW (ref mail from L.Dubbedam, 13/09/06)
 - AD-65 – SRON-G/HIFI/PR/2006-0xx - HIFI FM Integration & Functional procedures – (draft 4 available)
 - AD-72 - PACS-ME-TP-017_1.5 - SFTs test procedures – TBW
 - AD-81 – PACS-ME-TP-021_tbd - PACS IST procedures – TBW (Includes Commissioning, RMS & SPT)
 - AD-84 - SPIRE-RAL-PRC-00xxxx_xx – SPIRE Reference Mission Scenario Procedure (TBW)
 - AD-86 - SPIRE-RAL-PRC-00xxxx_xx – SPIRE Operation during PACS/SPIRE parallel mode test Procedure (TBW)
 - AD-87 – HIFI FM IST procedures – TBW
 - AD-88 – HIFI AVM IST Procedures - TBW
 - AD-91 – PACS-ME-TP-032_tbd - PACS EMC procedures - TBW
 - AD-92 – SPIRE EMC test procedures - TBW
 - AD-93 – HIFI EMC test procedures - TBW
 - AD-101 – PACS-ME-TP-032_tbd - PACS TV test procedures - TBW
 - AD-102 – SPIRE TV test procedures - TBW
 - AD-103 – HIFI TV test procedures - TBW

Astrium:

Precise the temperature bias on PACS when the satellite is tilted to 23° & 90°, vs filling level

ESA/ESOC

Add a references to ESOC specifications to Instruments to generate MTL from AOT

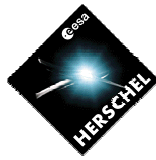

1. TEST OBJECTIVE

1.1 Introduction

This test specification defines the instrument tests sequences to be performed at satellite level during the Herschel AVM and PFM programme.

It is complementary to the Herschel IST specification AD-21.

This includes the instrument incoming inspections after delivery to Industry, the activities and interface tests planned for the instrument integration on the satellite (FPU in PLM Cryostat and warm units in SVM) and the instrument related tests to be performed during the various Herschel satellite test phases (SFT, IST, TV test & EMC). All these activities and tests are described per instrument and per test activity.

These tests sequences have been defined together with instruments teams, and in close collaboration with AAS-F engineering team responsible of the IST preparation, during dedicated IST preparation meeting where the objectives and constraints from both satellite and instrument sides have been explained.

This document is based on the Instrument Interface Documents (AD 1, AD 2, AD 3 and AD 4) and the Satellite AIT Plan (AD 5), instruments test plan (AD6) and takes into account the current status of the satellite AIT schedule and the information on desired test sequences provided by the instrument teams.

It has been elaborated with input from instruments, elaborated during dedicated technical meetings, after clarification of the aims of the IST.

1.2 Test objectives

1.2.1 Herschel FM Satellite/AVM Test Programme General Objectives

The objective of Herschel IST is twofold :

- to verify the correct performance of the satellite and the compatibility between all the integrated electrical subsystems and instruments,
- to validate the operation procedures which will be exercised during the different phases of the satellite mission.

More details in section 2.1 of IST specification AD 21

1.2.2 Instrument Specific Test Definitions and Objectives

The following table gives an overview of the instrument tests to be carried out on PLM PFM and satellite level with their instrument related objectives.

Test	Test Objectives	Conditions	Remarks
Instruments Integration tests	Check of instruments units during the integration process and UFT	Ambient, on warm Units only. Possibly with FPU simulator	2 types of verifications: - Integration tests:IF to SVM (1553, Power lines, insulation), - UFT: IF between warm units
Instrument Short Functional Test (SFT)	Test performed after connection of Warm units with FPU's Instrument switch-on and functional verification of instrument interfaces.	SFT warm: Ambient SFT cold: Tank	SFT warm: Before cool down of the cryostat. SFT cold: After cool down (He1) and after

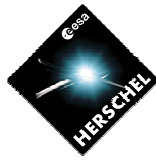

Test	Test Objectives	Conditions	Remarks
	Evaluation should preferably be based on housekeeping data. Two different types of instrument SFT's: warm and cold.	temperature 4.2 K (He1) or 1.7 K (He2)	He2 production.
Integrated System Test (IST)	Verification of the functional performance of the integrated instrument in all possible modes. Check of the instrument performance as far as possible with satellite configuration. 2 sequences are proposed : <ul style="list-style-type: none"> • Simulation of instrument commissioning. • Reference Mission Scenario. 	Tank temperature: 1.7 K	Before and after environmental tests. → Accelerated verification of instrument commissioning → 2 days simulated mission.
Instrument Specific Performance Test (SPT)	Verification of dedicated aspects of the performance of the integrated instrument that are not verified during IST. Tests may require a specific spacecraft configuration. SPT is part of the IST	Tank temperature: 1.7 K	Scheduling depending on test set-up requirements.
EMC Test	Check of functional performance of the integrated instrument under electromagnetic worst case conditions (radiated susceptibility) and measurement of instrument electromagnetic emissions (conducted and radiated emission).	Tank temperature: 1.7 K	2 tests - EMC1: CE Only - EMC2: RE (instruments in most noisy mode), then RS based on RE + margins (instruments in most sensitive mode)
Sine Vibration and Acoustic Noise Test	Verification of workmanship. Verification of alignment stability.	Tank temperature: 4.2 K	SFT will be performed before and after.
TB/TV Test	TMM validation. TB test : Equilibrium of cryostat under simulated (near) flight conditions . Verification of instrument performance in nearly flight conditions. TV test: Verification of instrument operation at when warm units are near limits of operating range.	Tank temperature: 1.7 K TV : CVV near 100K Warm units at – 10°C (cold soak, +40°C hot soak)	In LSS TV chamber. Cryostat tilt limited to <u>22°</u>
System Validation Test (SVT)	Verification of instrument commanding, telemetry and science data from/to the Mission Operation Centre.	Tank temperature: 1.7 K	Satellite level test. This test is under the responsibility of ESA/ESOC. Not covered in this specification

Table 1-1: Instrument related Tests on Herschel Satellite Level

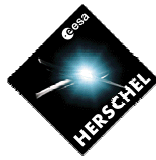

2. DOCUMENTS

2.1 Applicable documents

Rem: Documents **outlined** are still to be issued

Most documents are uploaded on ftp

ftp://ftp.hp-instruments.as-b2b.com/industry_to_instruments/Herschel%20FM%20tests/

Specifications

AD-01 – IID-A_3.5

AD-02 – PACS IID-B_4.0

AD-03 – SPIRE IID-B_4.0

AD-04 – HIFI IID-B_3.3

(IID-B's include also specific ICD's of AVM units when they differ from the FM)

AD-05 - H-P-1-ASPI-SP-0018_3.3 - PA Requirements for Subcontractors

AD-06 - H-P-1-ASPI-PL-0055_2.2 – PA Plan

AD-07 – S2K-MCS-ICD-0144-TOS-GCI_1.3 - SCOS 2000 OBSM External Interfaces Control Document

Test Plans :

AD-11 – [HP-2-ASED-PL-0026_2_2 - Herschel AIT Plan - Part 2 EPLM & SC-PFM Acceptance Phase \(RD 29 of IID-A\)](#)

AD-12 – HP-2-ASED-PL-0031_2 - Instrument Testing on Herschel PLM PFM and Satellite Level

AD-13 – H-P-1-ASP-TN-0852_1_0 - Instrument Testing on AVM level

AD-14 – SCI-PT-12759_3_0 - Reference Mission scenario

Test Specifications:

AD-21 – H-P-2-ASP-SP-0939_2.0 - Herschel IST test specification

AD-22 – H-P-2-ASP-TS-0997_1.0 - Herschel TV test specification - (31/8/05)

AD-23 – H-P-2-ASP-TS-0819_2.0 - Herschel EMC test specification - (TBW)

Mechanical Integration specifications

AD-31 - Herschel Warm units Integration specification – H-P-2-ASP-SP-1009_1

AD-32 – Herschel Instruments WIH integration specification – H-P-2-ASP-SP-1036_2

AD-33 - Herschel Instruments FPU Integration - TBW

FM Instruments Electrical integration specifications:

AD-41 - H-P-2-ASP-TS-1127_1.0 - HIFI WU to SVM Electrical Integration Specification (FM)

AD-42 - H-P-2-ASP-TS-1155_1.0 - PACS WU to SVM Electrical Integration Specification (FM)

AD-43 - H-P-2-ASP-TS-1160_1.0 - SPIRE WU to SVM Electrical Integration Specification (FM)

AVM Instruments Electrical integration specification.

AD-44 - H-P-SP-AI-0083 - HP Warm Units AVM Test Spec

Instruments User manuals

AD-51 – HIFI User Manual - SRON-U-HIFI-UM-2004-001_1_1.3

AD-52 – PACS User Manual - TBW

AD-53 – SPIRE User Manual - SPIRE-RAL-PRJ-002395_1

Instruments test Procedures

Post-shipment tests, Integration, UFT's, and SIT

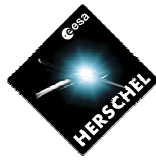

AD-61 - SPIRE-RAL-PRC-002680_1.0 - SPIRE WU Integration Test Procedures
AD-62 - PACS-ME-TP-016_1_4 - Test Procedure for PACS Warm Electronics Tests (includes incoming inspection & UFT)

AD-63 – SPIRE **Post- shipment tests** TBW

AD-64 - HIFI ICU AVM SFT – TBW (ref mail from L.Dubbedam, 13/09/06)

AD-65 – SRON-G/HIFI/PR/2006-0xx - HIFI FM Integration & Functional procedures – (draft 4 available)

SFT's FFT

AD-71 - SPIRE-RAL-PRC-002494_2.0 – SPIRE Short Functional Test Procedures

AD-72 - PACS-ME-TP-017_1.5 - SFTs test procedures – TBW

HIFI SFT – refer to AD65

IST

AD-81 – PACS-ME-TP-021_tbd - PACS IST procedures – TBW (Includes Commissioning, RMS & SPT)

AD-82 - SPIRE-RAL-PRC-002398_2.0 – SPIRE Cold Functional Test Procedures

→will be used for SPIRE FM IST/Commissioning

AD-83 - SPIRE-RAL-PRC-002422_2.0 – SPIRE Warm Functional Test Procedures

→will be used for SPIRE AVM IST/Commissioning

AD-84 - SPIRE-RAL-PRC-00xxxx_xx – SPIRE Reference Mission Scenario Procedure (TBW)

AD-85 - SPIRE-RAL-PRC-002704_1.0 - SPIRE Special Performance Test Procedures

AD-86 - SPIRE-RAL-PRC-00xxxx_xx – SPIRE Operation during PACS/SPIRE parallel mode test Procedure (TBW)

AD-87 – HIFI FM IST procedures – TBW

AD-88 – HIFI AVM IST Procedures - TBW

EMC

AD-91 – PACS-ME-TP-032_tbd - PACS EMC procedures - TBW

AD-92 – SPIRE EMC test procedures - TBW

AD-93 – HIFI EMC test procedures - TBW

TV test

AD-101 – PACS-ME-TP-032_tbd - PACS TV test procedures - TBW

AD-102 – SPIRE TV test procedures - TBW

AD-103 – HIFI TV test procedures – TBW

2.2 Reference documents

Herschel AVM & FM design descriptions

RD-01: H-P-TN-AI-0052_2 - Herschel/Planck SVM AVM Technical Description

RD-02: HP-2-ASED-RP-0011_4; H-EPLM Thermal Model and Analysis – (RD 81 of IID-A)

RD-03: HP-2-ASED-TN-0115 - Thermal Environment for (Herschel) Instruments testing on Ground – (RD99 of IID-A)

RD-04: HP-2-ASED-RP-0003 - H-EPLM Design Description (RD48 of IID-A)

RD-05: H-P-RP-AI-0005_3_0 - SVM Design Report (RD46 of IID-A)

RD-06: H-P-1-ASP-TN-1170_1.0 - H/P IST (SVM) thermal predictions

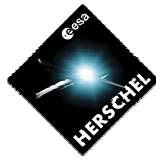

Herschel QM test procedures and test reports

RD-21 Herschel EQM Summary report HP-2-ASED-TR-0092_1 (1/2/06)

All detailed QM test procedures and reports references are compiled in RD21, and are available on ftp:

<ftp://ftp.hp-instruments.as->

[b2b.com/industry_to_instruments/Herschel%20EQM%20tests/EQM%20Test%20-%20Reference%20Documents/](ftp://ftp.hp-instruments.as-b2b.com/industry_to_instruments/Herschel%20EQM%20tests/EQM%20Test%20-%20Reference%20Documents/)

Herschel STM test reports

RD-31: HP-2-ASED-RP-0174_1 - Herschel STM TB-TV Test Results Evaluation -

RD-32 : HP-2-ASED-RP-0180_1 - Herschel STM TV test - Evaluation of Herschel Instruments Thermal interface results.

Herschel Instruments DPU AVM test report

RD-41 - H-P-RP-AI-0170_01 - Herschel Instruments AVM Test Report (PACS, SPIRE, HIFI)

2.3 Acronyms

AD: Applicable document

AVM: AVionic Model

CFT: Cold Functional Test

DTCP: Daily Tele-Communication Period

EGSE: Electrical Ground Support Equipment.

FM: Flight Model

HOT: Helium One Tank (=Auxiliary tank of Herschel cryostat)

HTT: Helium Two Tank (=Main tank of Herschel cryostat)

I-EGSE Instrument EGSE

ILT: Instrument Level Test

IST: Integrated System test

RD: Reference Document

RMS: Reference Mission Scenario

SFT: Short Functional Test

SIT: Subsystem Integration Test. (Functional Test performed when all instruments units are integrated)

SPT: Special Performance Test

SVT: System Validation Test (from ESOC)

TV/TB: Thermal Vacuum/Thermal Balance test

UFT: Unit Functional Test (Test performed during integration of instruments Units)

W(F/S)FT: Warm (Full/short) Functional test

WU: (Instruments) Warm units

Instruments warm units acronyms are defined in the next section.

3. TEST SPECIMEN DEFINITION

The Satellite, SVM and cryostat configurations are described in the following documents.

RD-04: HP-2-ASED-RP-0003 - H-EPLM Design Description (RD48 of IID-A)

RD-05: H-P-RP-AI-0005_3_0 - SVM Design Report (RD46 of IID-A)

For IST, the satellite configuration is described in AD-21 (IST Specification).

Only the instruments configuration for FM and AVM and the Herschel Cryostat configuration during the tests is given here.

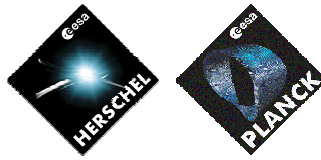

For AVM tests, the AVM configuration is given in this document:
RD-01: H-P-TN-AI-0052_2 - Herschel/Planck SVM AVM Technical Description

3.1 Instruments Configurations for AVM & FM tests

3.1.1 HIFI:

Table 3-1: HIFI AVM & FM Configuration

Satellite	Instrument	Product tree id	description	code	AVM	PFM	Comments
Herschel	HIFI	111110	Focal Plane Unit	FH FPU	N/A	FM	
Herschel	HIFI	111230	Focal Plane Control Unit	FH FCU	N/A	FM	AVM=Resistor 53 Ohms
Herschel	HIFI	111260	Instrument Control Unit	FH ICU	AVM2	FM	
Herschel	HIFI	111270	IF upconverter Horizontal	FH IFH	N/A	FM	
Herschel	HIFI	111271	IF up converter Vertical	FH IFV	N/A	FM	
Herschel	HIFI	111120	Local Oscillator Unit	FH LOU	N/A	FM	
Herschel	HIFI	111125	Local Oscillator Radiator	FH LOR	N/A	FM	
Herschel	HIFI	111210	Local Oscillator Control Unit	FH LCU	Simulator	FM	AVM=Resistor 9.5 Ohms
Herschel	HIFI	111220	Local Oscillator Source Unit	FH LSU	N/A	FM	
Herschel	HIFI	111230	Bridging wave-guides	FH BWG	N/A	FM	
Herschel	HIFI	111241	HRS ACS Horizontal polarisation	FH HRH	Simulator	FM	AVM=Resistor 11.5 Ohms
Herschel	HIFI	111242	HRS ACS Vertical polarisation	FH HRV	Simulator	FM	AVM=Resistor 11.5 Ohms
Herschel	HIFI	111251	WBS Electronics for Horizontal Polarisation	FH WEH	Simulator	FM	AVM=Resistor 25.3 Ohms
Herschel	HIFI	111252	WBS Electronic for Vertical Polarisation	FH WEV	Simulator	FM	AVM=Resistor 25.3 Ohms
Herschel	HIFI	111253	WBS Optic for Horizontal Polarisation	FH WOH	N/A	FM	
Herschel	HIFI	111254	WBS Optic for Vertical Polarisation	FH WOV	N/A	FM	
Herschel	HIFI	111311	LCU to LSU secondary Power Main	FH WIH	N/A	FM	
Herschel	HIFI	111312	LCU to LSU secondary Redundant	FH WIH	N/A	FM	
Herschel	HIFI	111313	ICU to FCU secondary Main	FH WIH	N/A	FM	
Herschel	HIFI	111314	ICU to FCU secondary Redundant	FH WIH	N/A	FM	
Herschel	HIFI	111321	ICU Main to LCU Main	FH WIH	N/A	FM	
Herschel	HIFI	111322	ICU redundant to LCU Redundant	FH WIH	N/A	FM	
Herschel	HIFI	111323	ICU main to FCU Main	FH WIH	N/A	FM	
Herschel	HIFI	111324	ICU redundant to FCU Redundant	FH WIH	N/A	FM	
Herschel	HIFI	111325	ICU Main to HRH	FH WIH	N/A	FM	
Herschel	HIFI	111326	ICU Main to HRV	FH WIH	N/A	FM	
Herschel	HIFI	111327	ICU Main to WEH	FH WIH	N/A	FM	
Herschel	HIFI	111328	ICU Main to WEV	FH WIH	N/A	FM	
Herschel	HIFI	111329	ICU Redundant to HRH	FH WIH	N/A	FM	
Herschel	HIFI	111330	ICU Redundant to HRV	FH WIH	N/A	FM	
Herschel	HIFI	111331	ICU Redundant to WEH	FH WIH	N/A	FM	
Herschel	HIFI	111332	ICU Redundant to WEV	FH WIH	N/A	FM	
Herschel	HIFI	111333	LCU main to LSU Main	FH WIH	N/A	FM	
Herschel	HIFI	111334	LCU redundant to LSU Redundant	FH WIH	N/A	FM	
Herschel	HIFI	111341	LSU to HRH	FH WIH	N/A	FM	
Herschel	HIFI	111342	LSU to HRV	FH WIH	N/A	FM	
Herschel	HIFI	111343	LSU to WEH	FH WIH	N/A	FM	
Herschel	HIFI	111344	LSU to WEV	FH WIH	N/A	FM	
Herschel	HIFI	111345	HRH to HRV	FH HRS	N/A	FM	
Herschel	HIFI	111346	HRV to HRH	FH HRS	N/A	FM	
Herschel	HIFI	111347	3DH to HRH	FH WIH	N/A	FM	
Herschel	HIFI	111348	3DH to WEH	FH WIH	N/A	FM	
Herschel	HIFI	111349	3DV to HRV	FH WIH	N/A	FM	
Herschel	HIFI	111350	3DV to WEV	FH WIH	N/A	FM	
Herschel	HIFI	111351	WEH to WOH	FH WBS	N/A	FM	
Herschel	HIFI	111352	WEV to WOV	FH WBS	N/A	FM	
Herschel	HIFI	111510	HIFI MGSE	FH		FPU handling frame	same QM-FM
Herschel	HIFI	111520	HIFI Unit transport Container	FH	yes	yes	
Herschel	HIFI	111530	HIFI EGSE	FH			Common I-EGSE for all Herschel Instruments



3.1.2 SPIRE

Table 3-2: SPIRE AVM & FM Configuration

Satellite	Instrument	Product tree id	description	code	code	AVM	PFM	Comments
Herschel	SPIRE	112110	Focal Plane Unit	HS	FPU		PFM	FPU + JFET to be integrated
Herschel	SPIRE	112122	JFET (Spectrometer)	HS	JFP	DRCU Simulator (one computersimulating FPU/DCU/FCU)	PFM	
Herschel	SPIRE	112121	JFET (Photometer)	HS	JFS		PFM	
Herschel	SPIRE	112220	Focal Plane Control unit	HS	FCU		PFM	
Herschel	SPIRE	112230	Detector Control unit	HS	DCU		PFM	
Herschel	SPIRE	112210	Digital Processing Unit	HS	DCU	AVM2	PFM	
Herschel	SPIRE	112311	W1 HSDPU-P to HSDCU-P	HS	W1	QM1	PFM	harnesses
Herschel	SPIRE	112312	W2 HSDPU-R to HSDCU-R	HS	W2	QM1	PFM	harnesses
Herschel	SPIRE	112313	W3 HSDPU-P to HSSCU-P	HS	W3	QM1	PFM	harnesses
Herschel	SPIRE	112314	W4 HSDPU-R to HSSCU-R	HS	W4	QM1	PFM	harnesses
Herschel	SPIRE	112315	W5 HSDPU-P to HSMCU-P	HS	W5	QM1	PFM	harnesses
Herschel	SPIRE	112316	W6 HSDPU-R to HSMCU-R	HS	W6	QM1	PFM	harnesses
Herschel	SPIRE	112317	W7 HSFCU-P to HSDCU-P	HS	W7	QM1	PFM	harnesses
Herschel	SPIRE	112318	W8 HSFCU-R to HSDCU-R	HS	W8	QM1	PFM	harnesses
Herschel	SPIRE	112131	JFP to FPU	HS	BP	QM1	PFM	harnesses
Herschel	SPIRE	112132	JFS to FPU	HS	BS	QM1	PFM	harnesses
Herschel	SPIRE	112510	SPIRE MGSE	HS			FPU handling frame	same QM-FM
Herschel	SPIRE	112511	SPIRE unit transport containers	HS		yes	yes	
Herschel	SPIRE	112512	SPIRE instrument/cryostat integration Jig/equipment	HS				
Herschel	SPIRE	112530	SPIRE EGSE	HS			- FPU Simulator - QLA software	Common I-EGSE for all Herschel Instruments

3.1.3 PACS

Table 3-3: PACS AVM & FM Configuration

Satellite	Instrument	Product tree id	description	code	code	AVM	PFM	Comments
Herschel	PACS	113110	Focal Plane Unit	FP	FPU	Simulator	PFM	
Herschel	PACS	113210	Detector & Mechanism Control (DEC/MEC)	FP	DECMEC	EM (Form Fit)	PFM	EM fits FM envelop
Herschel	PACS	113230	Bolometer Cooler Control unit	FP	BOLC	QM1 (Form Fit)	PFM	No Power supply layer
Herschel	PACS	113240	Data Processing Unit	FP	DPU	AVM (Form Fit Function)	PFM	AVM type TBC
Herschel	PACS	113250	Signal processing unit Nominal (stacked with redundar	FP	SPU1	AVM (Form Fit)	PFM	stacked
Herschel	PACS	113260	Signal processing unit Redundant	FP	SPU2	N/A	PFM	
Herschel	PACS	113311	DPU nominal to MEC1	FP		AVM	PFM	
Herschel	PACS	113312	DPU redundant to MEC2	FP		AVM	PFM	
Herschel	PACS	113313	DPU nominal to SWL SPU nominal	FP		AVM	PFM	
Herschel	PACS	113314	DPU nominal to LWL SPU nominal	FP		AVM	PFM	
Herschel	PACS	113315	DPU redundant to SWL SPU redundant	FP		AVM	PFM	
Herschel	PACS	113316	DPU redundant to LWL SPU redundant	FP		AVM	PFM	
Herschel	PACS	113321	SPU nominal to MEC1	FP		AVM	PFM	
Herschel	PACS	113322	SPU redundant to MEC2	FP		AVM	PFM	
Herschel	PACS	113331	MEC1 to SWL SPU (nominal)	FP		AVM	PFM	
Herschel	PACS	113332	MEC1 to LWL SPU (nominal)	FP		AVM	PFM	
Herschel	PACS	113333	MEC2 to SWL SPU (redundant)	FP		AVM	PFM	
Herschel	PACS	113334	MEC2 to LWL SPU (redundant)	FP		AVM	PFM	
Herschel	PACS	113335	MEC1 to BOLC data (nominal)	FP		AVM	PFM	
Herschel	PACS	113336	MEC1 to BOLC Sync (nominal)	FP		AVM	PFM	
Herschel	PACS	113337	MEC2 to BOLC data (redundant)	FP		AVM	PFM	
Herschel	PACS	113338	MEC2 to BOLC Sync (redundant)	FP		AVM	PFM	
Herschel	PACS	113339	MEC1 to DEC1 data (nominal)	FP		AVM	PFM	Internal do DECMEC
Herschel	PACS	113340	MEC1 to DEC1 Sync (nominal)	FP		AVM	PFM	Internal do DECMEC
Herschel	PACS	113341	MEC1 to DEC2 data (nominal)	FP		AVM	PFM	Internal do DECMEC
Herschel	PACS	113342	MEC1 to DEC2 Sync (nominal)	FP		AVM	PFM	Internal do DECMEC
Herschel	PACS	113343	MEC2 to DEC1 data (redundant)	FP		AVM	PFM	Internal do DECMEC
Herschel	PACS	113344	MEC2 to DEC1 Sync (redundant)	FP		AVM	PFM	Internal do DECMEC
Herschel	PACS	113345	MEC2 to DEC2 data (redundant)	FP		AVM	PFM	Internal do DECMEC
Herschel	PACS	113346	MEC2 to DEC2 Sync (redundant)	FP		AVM	PFM	Internal do DECMEC
Herschel	PACS	113510	PACS MGSE	FP			FPU handling frame	same QM-FM
Herschel	PACS	113511	PACS unit transport containers	FP		yes	yes	
Herschel	PACS	113520	PACS EGSE	FP				Common I-EGSE for all Herschel Instruments

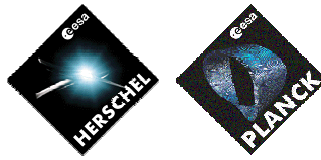

3.2 EGSE Configurations for AVM & FM tests

3.2.1 Satellite EGSE configuration

The EGSE configuration during the Herschel Satellite test phase is the following.

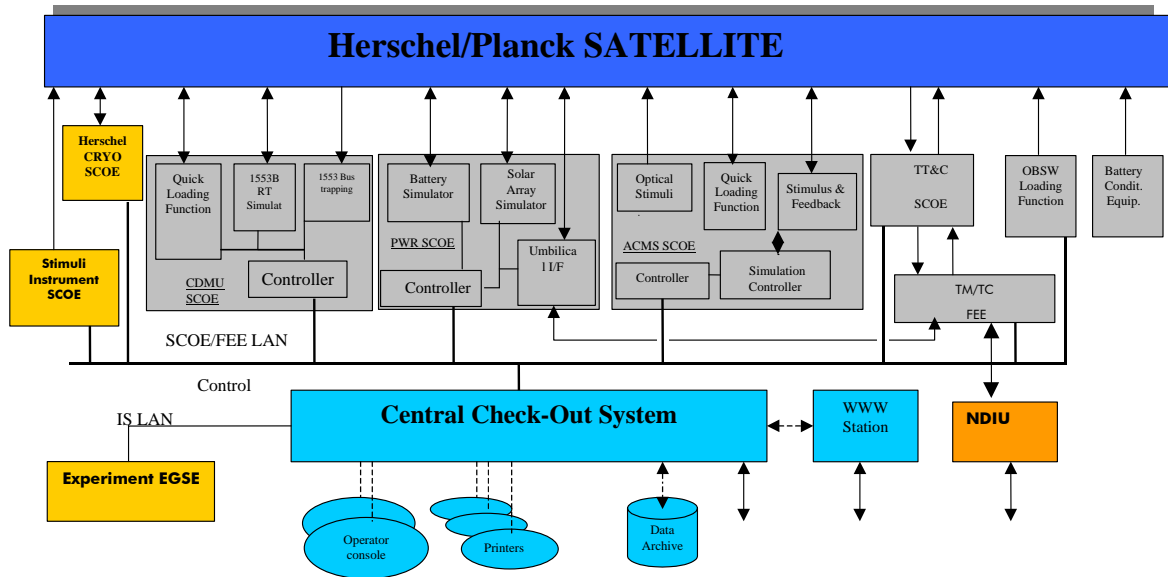

Figure 3-1: Satellite EGSE Configuration

3.2.2 Instruments EGSE

Instrument I-EGSE will be used by instrument teams during most of the tests mainly to analyse the instrument science and housekeeping data, using the QLA (Quick Look Analysis) tool, or dedicated analysis software.

There is a common I-EGSE for all 3 Herschel instruments.

The EGSE configuration is given here below:

Instrument	GSE	Remarks
HIFI/PACS/SPIRE	2 Instrument EGSE Stations for all 3 instruments	One EGSE Station operated in real time, the other one used as backup or for post processing tasks
HIFI	FPU simulator, <u>LOU Simulator;</u> <u>No EGSE to check integrated FPU</u>	To be connected on HIFI WU for warm SFT
PACS	<u>no FPU Simulator No EGSE to check integrated FPU</u>	
SPIRE	<u>no FPU Simulator No EGSE to check integrated FPU</u>	

Table 3-4: Instrument EGSE Items

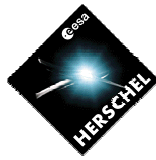

The Instrument EGSE Station is composed by the following items:

- SCOS workstation – used primarily to run the SCOS-2000 software. This will be a PC running Linux with a dual display card driving two displays.
- Analysis workstation – used to run the instrument analysis software (QLA/IA/PCSS). This will be a PC running Linux with a dual display card driving two displays.
- Data Server – used primarily to run the HCSS software. This will be a PC running Linux with a single display and large disk drives with backup facility (to tape/CD TBD).
- Colour laser printer.
- LAN switch - protects the Operational System from the Analysis System allowing access to the external internet from the Analysis System.
- Laptops – used to run instrument specific analysis tools. These are not provided as part of the EGSE but may be used by instrument experts as necessary during testing.

The I-EGSE Software configuration is the following:

- SCOS Version 2.3e patch 5
- HCSS User Release 0.2.3 (Developer Build 515)
- PCSS Built 20041115A

For QM test 2 complete (Nominal & Redundant) IEGSE were used.

After EQM, the Nominal I-EGSE is following the Herschel Cryostat (sent to ASED-FN, then to Estec), and will be used for FM test, and the redundant I-EGSE has been sent to Alenia, and will be used for the AVM tests.

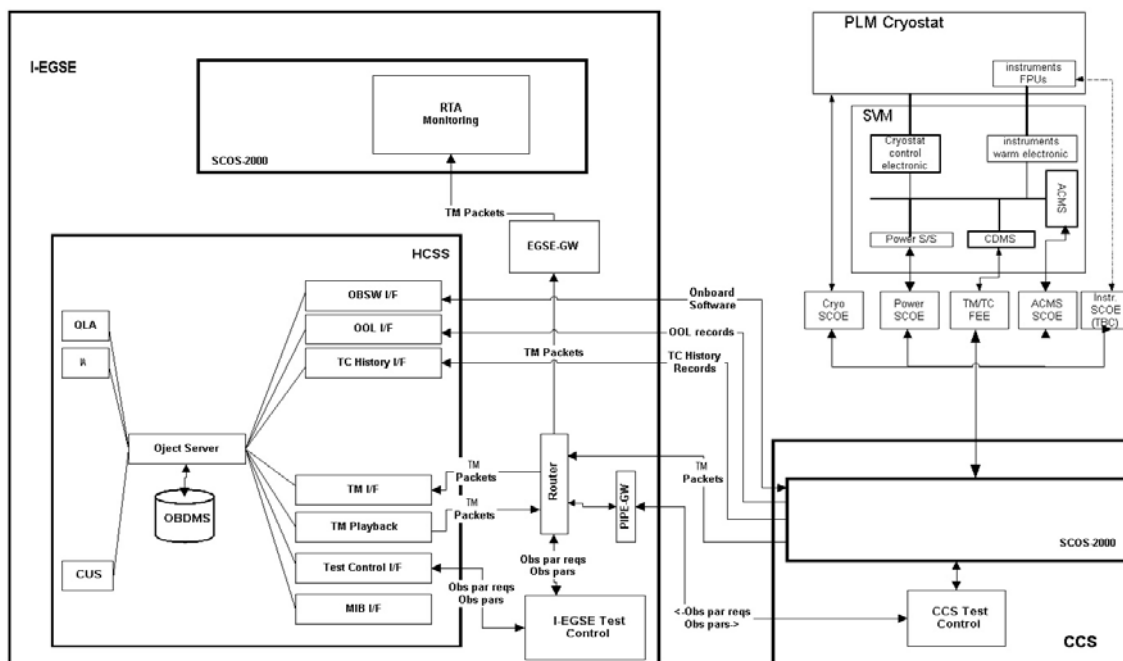

Figure 3-2: Herschel Instruments I-EGSE configuration.



In addition to the function of real time data analysis, the I-EGSE is used to provide the TC parameters to the CCS for test driven by TCL scripts.

The interaction between CCS and I-EGSE is described [here bellow](#):

The Herschel instrument commanding during IST is done like:

Test procedure running on CCS sends a "running test_procedure x" TC to IEGSE
IEGSE start test execution

Test procedure running on CCS sends a "request observation x" TC to IEGSE
IEGSE requests observation x

IEGSE retrieves TC sequence

IEGSE extracts number of TCs, sequences of TCs names, parameter for TCs and execution times

IEGSE sends all this information as TM packets to CCS

Test procedure running on CCS waits for all TM packets to arrive

Test procedure checks that number of expected TCs has not changed

Test procedure checks that sequence of TCs (names) has not changed

Test procedure fills all TC parameters with those actual values received from IEGSE

Test procedure maintains TC timing as received from IEGSE

Test procedure executes than the TC sequence

Finally at the end the test procedure sends a TC to IEGSE to indicate end of test

IEGSE closes test execution

Summary:

CCS sends TCs to IEGSE to trigger actions

IEGSE responds by sending TM packets.

Those TM packets contains information about TCs send from CCS to `_instrument_`

CCS extract data from IEGSE TM packets to construct TCs to be send to the instrument

CCS send the resulting TCs to the instrument

3.3 Instruments database configuration.

The instrument database shall be Part of the instrument AVM or FM EIDP

It shall be under Configuration

It shall be sent to ASP-F (F.Chatte) for compatibility check with, and to be integrated to HPSDB at least 3 weeks before the test.

As the database version is likely to change after checking, the database issue to be used for the test shall be frozen at the TRR

3.4 Instruments software configuration.

The instruments boot and application software version used in the DPU/ICU and other warm units when applicable shall be described in the instrument AVM or FM EIDP, and acknowledged at the DRB, and TRR.

3.5 Cryostat Configuration for IST and TV test.

The cryostat cryogenics conditions (IF temperatures a mass flow rate) will not be fully representative of the flight, because either on ground, or during TV test, the heat load distribution inside the cryostat and expected mass flow rate will be different from Orbit.

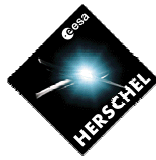

3.5.1 Cryostat Operation during IST:

On ground, the cryostat is usually in ground lifetime conditions. This means that the CVV is at 295K (temperature of the clean room), and the temperature of the HTT is maintained at about 1.7K by external pumping (bypassing the Phase separator via V104, and the nozzles via V502). The nominal mass flow rate with these conditions is about 26mg/s, and the temperature of the Optical bench is high.

The Instruments thermal interfaces conditions are described in the document RD-03: HP-2-ASED-TN-0115 - Thermal Environment for (Herschel) Instruments testing on Ground – (RD99 of IID-A, available on IIDA reference documents ftp site)

For IST, the main tank will be closed (ie V102/V104 closed), and the cooling of the OBA and shields will be provided by the auxiliary tank HOT, with a gas Helium flow forced to about 100mg/s by heating the HOT.

This mean that the conditions will be "quasi stationary": the main tank temperature will slowly drift up (about 0.3mK/h).

This configuration has a limited autonomy between refilling: 24h when the satellite is vertical (or 20° tilt) and the HOT can be completely filled.

At 90° tilt, the HOT can only be filled at 50% (the exhaust pipe must be in the gas), and the autonomy drops to 12h.

This means that it is not compatible with the RMS (Reference Mission scenario), where 48h Autonomy is needed.

Then during Reference mission scenario, a solution where the HOT is replaced by an external dewar to cool the instruments interfaces L1, L2, L3, and the thermal shields will have to be implemented. This has already been used during Herschel EQM tests)

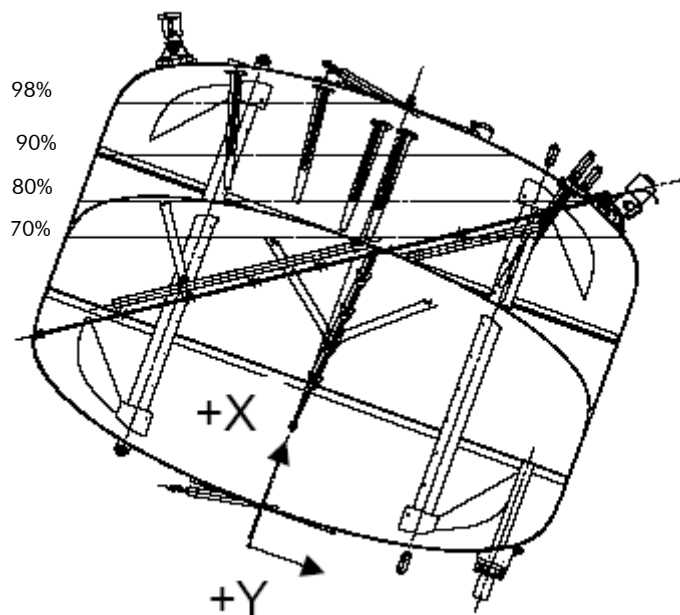

During the IST / Commissioning, the satellite will be tilted, from X vertical, of about +23° around +Z axis (ie +Y goes down) for cooler recycling.



SPIRE Commissioning will be performed at the end, when the satellite will be tilted to +90° (same rotation axis), to allow the use of the SPIRE spectrometer mode.

Then, during the RMS, the satellite will remain tilted at +90°, allowing both the cooler recycling, and the use of SPIRE spectrometer mode.

There will be a small temperature bias for PACS IF temperature when the satellite is tilted at 90° depending on the filling Level. At 90° tilt, and for a 90% fill, all PACS PODS will be in the liquid.

During IST, the cryo-cover can be actively cooled to <20K by circulation of liquid Helium (similar to EQM test). On FM cryostat, the cover shield has been re-polished (which means that it has a low emissivity, lower than the telescope).

3.5.2 Cryostat Operation during TV/TB test:

During the TV test, the simulated TV conditions will not be the space conditions, as the shrouds are cooled by LN2 to approximately 90K. Therefore, the CVV equilibrium temperature is about 100K (compared to 70K in space), and the equilibrium mass flow rate will be about 4mg/s (compared to 2.2 in space). However, for a limited amount of time, the mass flow rate can be throttled to the expected flight mass flow rate, but with a subsequent small temperature drift on the main tank.. The drift is estimated to be between 0.18mK/h (with assumptions: 300kg He at 1.8K, 3mg/s) to 0.48mK/h (with assumptions: 280kg He at 1.6K, 3mg/s)

The cover will be passively cooled during this phase, and a temperature of 85K can be achieved passively on the inner shield.

An other limitation during the TV test is that the satellite can only be tilted by 22° (TBC) wrt vertical (23° requested in IID-B's).

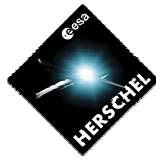

Refer also to Herschel PLM TV test report for actual test conditions (RD 31 & 32). Note that the cryostat performances has been improved between STM test and STM2 test, and that STM2 test results might (not available before end 2006) be more relevant for actual cryostat performances.

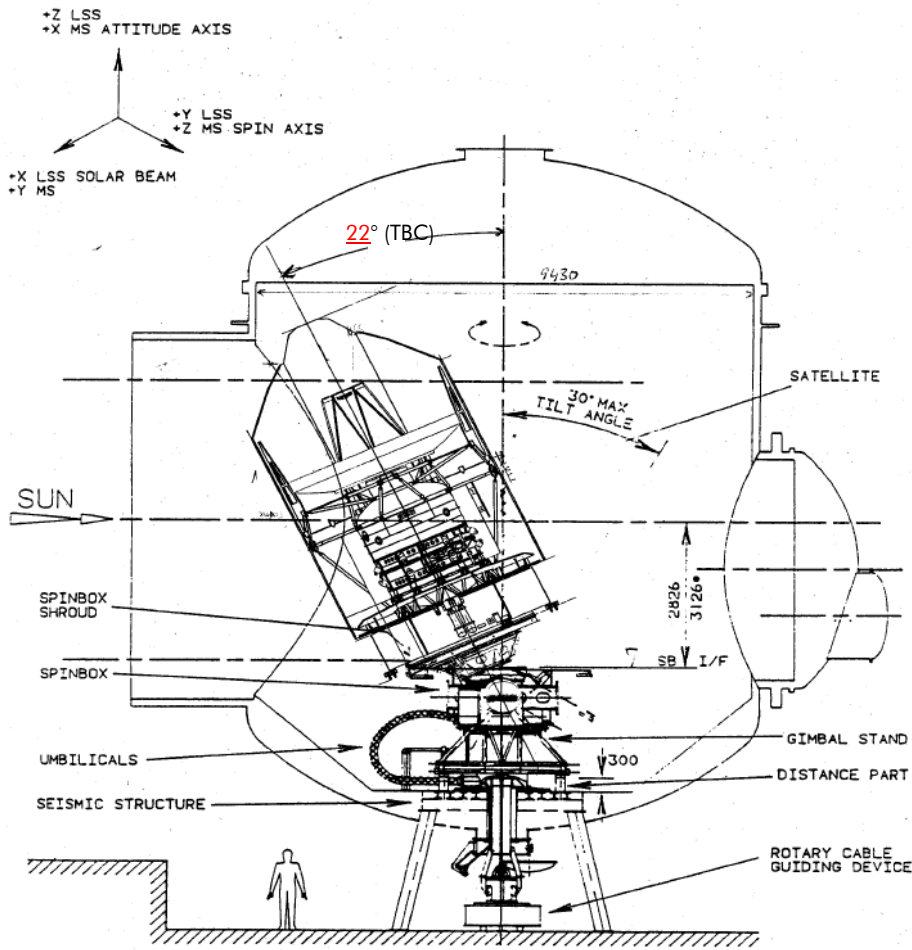

3.5.3 Cryostat Operation during EMC tests:

During the EMC test, the approach applied successfully during the QM test will be used: The cover is continuously flushed to low temperature (day & night). The PACS or SPIRE sorption cooler will be recycled the evening preceding the instrument test. The satellite will need to be tilted by 90° for SPIRE spectrometer test.

3.6 SVM thermal Configuration for Integration, IST/EMC and TV test.

The SVM has been designed for flight conditions. When using the SVM on ground, the temperature of the warm units might rise to unacceptable temperature, due to inefficiency of the radiator in clean-room conditions.

For this purpose, air conditioning systems will be used to blow cold air on the SVM panels., in order to provide as much as possible warm units temperature inside the specified operating range.



However, there are some units for which operating temperatures cannot be reached:
The HIFI WOH & WOV, with operating range [5°C, 15°C] will be at about 25°C
The HIFI HRH & HRV with operating range [0°C-30°C] will be at about 32°C during IST

The details of the expected IST/EMC test conditions are given in the following technical note:
RD-06: H-P-1-ASP-TN-1170_1.0 - H/P IST (SVM) thermal predictions

For EMC, it shall be checked the compatibility of air conditioning equipment with the EMC test objectives, or find a way to move away these units while transporting cold air to the panels through dedicated pipes..

For TV test, the Radiators will be operating properly, and units should be inside the temperature range. Refer to SVM TV test prediction when it will be available.

4. TEST DEFINITION

4.1 Overview of Herschel AVM & FM tests sequence

The Herschel Spacecraft, after integration (and instruments integration tests and UFT), will be submitted to Acceptance environment tests (TV test, EMC test, and Mechanical tests).

Before and after Environment test, the satellite will be submitted to Integrated System Tests (IST, ref RD21), with the aim to verify all (or at least most of) functionalities and modes of the Spacecraft and Instruments are performing correctly, and that they are not altered by the environmental tests.

Before and after each environment test, SFT will be performed to health check of the instruments.

The overall test logic on the FM is described in the following flow diagram.

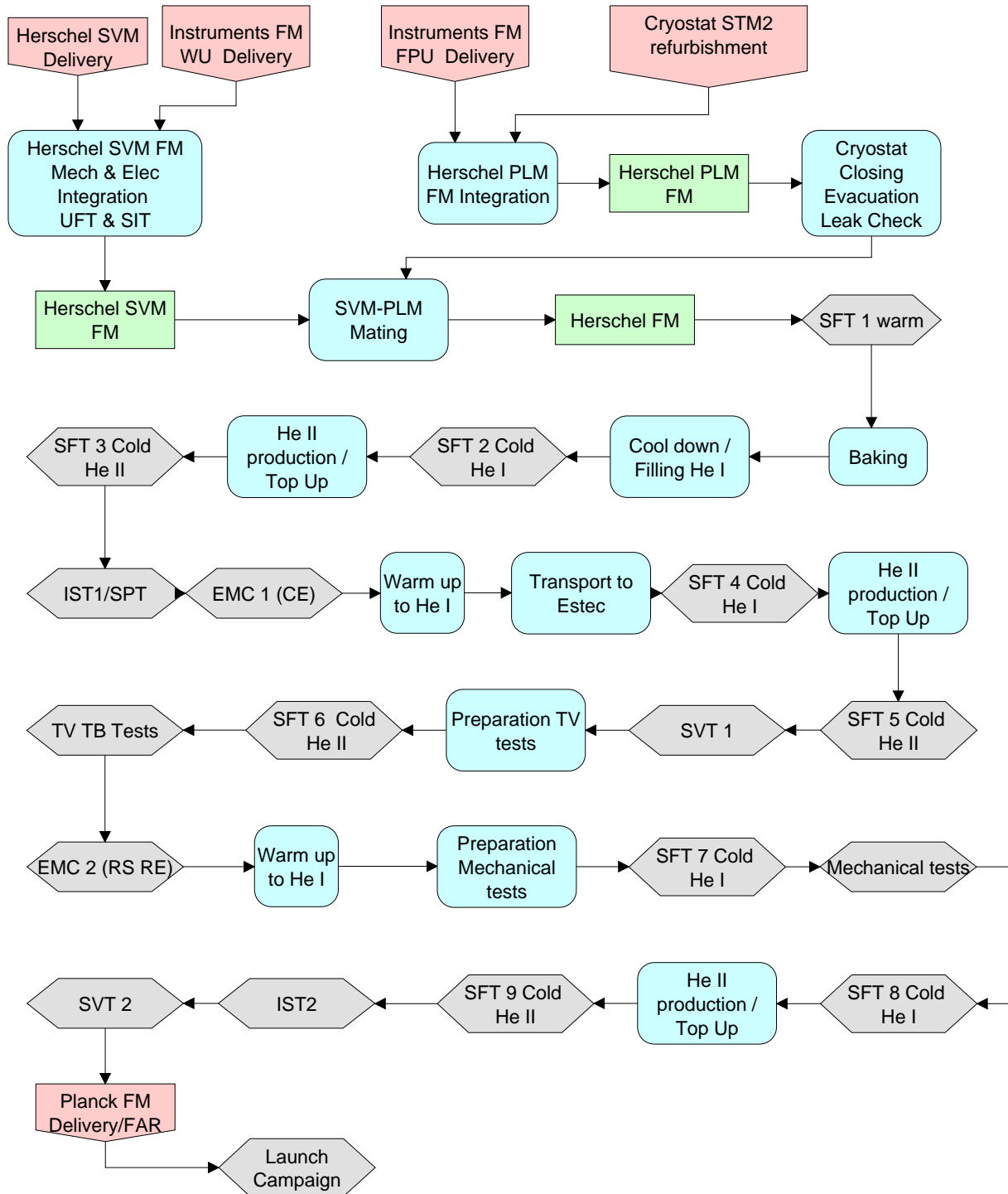
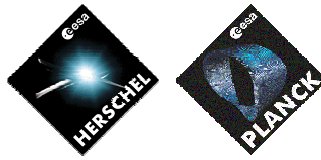

Figure 4-1: Herschel FM test sequence flow chart

The launch campaign is not defined yet (out of contract), but it is likely that SFT will be performed after transport to Kourou, and on launcher, and that an IST sequence will be run in the preparation rooms..



The sequence & duration of each activity is given in the following table

Table 4-1: Herschel FM test sequence table. Typical date for test after delivery is given for information only)

Activity	Duration	days after instrument		where	Temperature
§ 5 Instruments Delivery / incoming		start	end	ASED-FN	
Integration Instruments WIH & Warm Units on panels	37d	6.0	48.0	ASED-FN	warm
§5.5 - Instrument FPU integration CR100	20d	6.0	28.0	ASED-FN	warm
Intégration of WU panels on SVM	7d	48.0	56.0	ASED-FN	warm
instrument integration test	8.5d	56.0	67.0	ASED-FN	warm
cryostat closure	23.5d	68.0	94.0	ASED-FN	warm
Evacuation & Leak test	10.5d	94.0	105.0	ASED-FN	warm
SFT-1 (Warm)	2d	108.0	110.0	ASED-FN	warm
Bake Out	12d	110.0	122.0	ASED-FN	warm
Connection of HIFI WG to WU	1d	110.0	111.0	ASED-FN	warm
cooldown and filling of HTT & alignment	10d	122.0	132.0	ASED-FN	warm
SFT-2 - short functional test instruments - cold (He I)	1d	139.0	139.0	ASED-FN	Hel
He II Production & top up	7d	140.0	147.0	ASED-FN	He I
IST 1 - S/S SFT's (6/7)	20d	147.0	166.0	ASED-FN	Hell
microvibration measurement by activating the reaction wheels		147.0	150.0	ASED-FN	Hell
Special Performance Tests (SPT)/ IMT 6/7	10d	167.0	176.0	ASED-FN	Hell
§4.5.2 - EMC test (CE)	4d	176.0	180.0	ASED-FN	Hell
Conversion to He I	1d	180.0	180.0	ASED-FN	He I
Satellite Final Intégration (Telescope, solar array,)	17d	195.0	215.0	ASED-FN	He I
Integration of LOU Radiator	1d	208.0	208.0	ASED-FN	He I
Transport to Estec	4d	221.0	224.0	ASED-FN	He I
SFT 3 - short functional test - Cold He I	0.5d	229.0	229.0	ASED-FN	He I
He II Production & top up	6d	237.0	240.0	ASED-FN	He I
SVT 1 (5/7)	15d	243.0	265.0	Estec	Hell
SFT 4 - short functional test - He Ii	1d	285.0	286.0	Estec	Hel
TB/TV test	30.5d	288.0	318.0	Estec	Hell
TB/TV test (phases tbd)	23d	293.0	316.0	Estec	Hell
microvibration measurement by activating the reaction wheels	1d	293.0	294.0	Estec	Hell
tilting of S/C on request (PPS test, instrument testing)	1d	293.0	294.0	Estec	Hell
alignment with alignment camera, videogrammetry (tbc)	23d	293.0	316.0	Estec	Hell
EMC test (RS-RE in CATR)	10d	321.0	333.0	Estec	Hell
Vibration tests	16d	346.0	363.0	Estec	Hel
SFT 6 - short functional test - He Ii	1d	349.0	349.0	Estec	Hel
vibration 3 axis (incl. HTT topping)	9d	350.0	361.0	Estec	Hel
acoustic noise test (4 runs)	2d	368.0	369.0	Estec	Hel
SFT 7 - short functional test - He Ii	1d	374.0	375.0	Estec	Hel
He II Production & top up	4d	389.0	393.0	Estec	He I
IST 2 - S/S SFT's (6/7) = 15 days in 8h per day basis	15d	396.0	410.0	Estec	Hell
Satellite PLM Alignment stability Check	5d	395.0	398.0	Estec	He I
Special Performance Tests (SPT)/ IMT 6/7	10d	410.0	419.0	Estec	Hell
SVT2	10d	444.0	455.0	Estec	Hell
FAR (kick off)	1d	440.0			
Launch campaign	53d	487.0	546.0	Kourou	

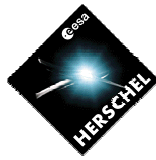

For AVM, the core of the IST (commissioning and Reference mission scenario, see below) will be run as a rehearsal for FM.

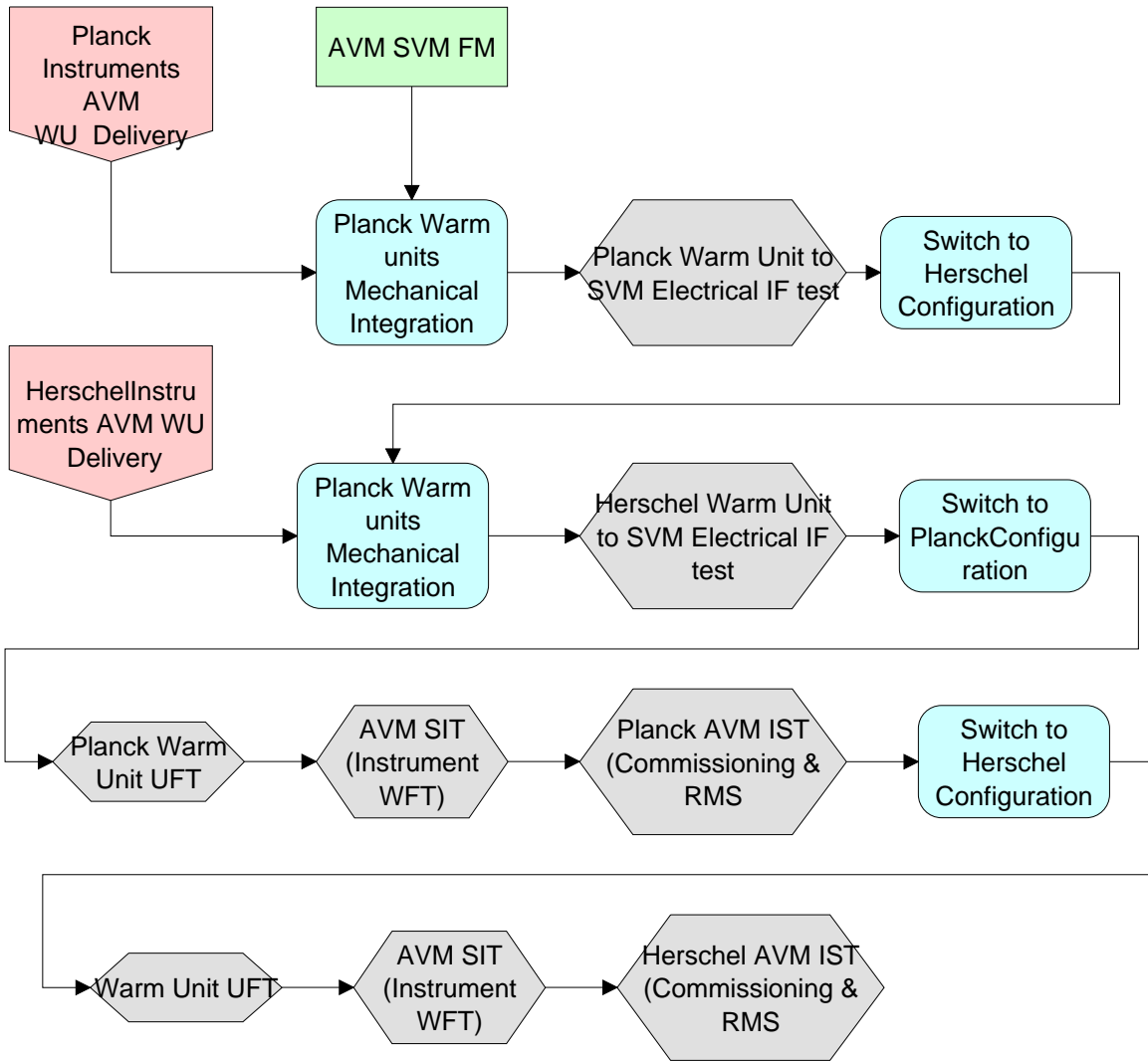
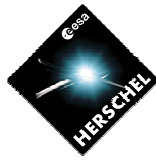

Figure 4-2: Herschel & Planck AVM integration & test sequence flow chart

4.2 Time Allocation for instruments tests

The time allocation for various instruments tests during the satellite FM sequence is the following. All sequences below are in agreement with this, except the HIFI TV test (78h)

	Allocation	type of AIT operation
SFT	2h/Instruments	Normal days 5d/7
Commissioning	1 day	Long days, 6d/7
RMS	14h/instrument	3 shifts, 7d/7
SPT	3 days/Instrument	Long days, 6d/7
TV	48h/instrument	3 shifts, 7d/7
EMC	2 days/Instruments	Long days, 6d/7



4.3 Incoming Inspection

At reception of instruments, there is usually an incoming inspection aimed to check that the instrument survived the transport, and is still operational.

The inspection (visual inspection) may be followed by an incoming inspection test, where the warm units are connected to each other, and to the I-EGSE, and a verification sequence is run.

For AVM,

Only PACS ask for such an incoming inspection test.

The test procedure is included in AD-62 (PACS-ME-TP-016_1_4 - Test Procedure for PACS Warm Electronics Tests) section 11.1 only (nominal chain)

The sequence is similar AVM-FM (see below)

For FM,

Incoming inspection will be performed for all instruments by the receiving party.

Post shipment test will be performed according to instrument procedures:

PACS:

The test procedure is included in AD-62 (PACS-ME-TP-016_1_4 - Test Procedure for PACS Warm Electronics Tests) section 11.1 (Nominal) and 11.1 (Redundant).

The sequence is the following:

Test with PACS WU AVM & FM integrated on SVM connected to I-EGSE	Duration
Switch-on (Nominal)	0:06:00
Simulated Spectroscopy Mode	
Simulated Photometry mode	
Enter SAFE mode	0:06:00
Switch off	

SPIRE:

AD-63 – SPIRE FM Post- shipment tests TBW

HIFI

AD-65 – SRON-G/HIFI/PR/2006-0xx - HIFI FM Integration & Functional procedures – (draft 4 available) (to be updated by HIFI to include the post shipment tests not in yet)

4.4 Instruments WU Integration tests, UFT (Unit Functional Test), and SIT (Subsystem Integration Test)

Integration test UFT, and SIT take place after instrument delivery, incoming inspections & post shipment tests, and are performed on warm units only (ie no connection to the FPU yet). Instruments may require to integrate an FPU simulator for the UFT (only HIFI).

These tests are to be split into 3 phases:

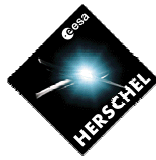

4.4.1 Electrical Integration tests

Integration tests, to validate the electrical interfaces between the instruments warm units, and the SVM, in a non loaded, then loaded configuration. It is limited to units having a direct interface to the SVM.

They consist in verification of

- 1: the power interface between PCDU, and all warm units connected to primary power lines.
- 2: The 1553 Interface between the CDMU and the instruments DPU's (or ICU)
- 3: The clock interface between the CDMU and any warm unit connected to the clock (PACS DECMEC).

4.4.1.1 Herschel AVM Instruments:

The integration specification is the following:

AD-44 - H-P-SP-AI-0083 - HP Warm Units AVM Test Spec
(includes all Herschel & Planck AVM instruments).

4.4.1.2 Herschel FM Instruments:

The Integration specifications are the following:

AD-41 - H-P-2-ASP-TS-1127_1.0 - HIFI WU to SVM Electrical Integration Specification (FM)
AD-42 - H-P-2-ASP-TS-1155_1.0 - PACS WU to SVM Electrical Integration Specification (FM)
AD-43 - H-P-2-ASP-TS-1160_1.0 - SPIRE WU to SVM Electrical Integration Specification (FM)

4.4.2 Instruments full software image patch with OBSM (AVM only)

This test of the instrument software patching with OBSM will be performed on AVM only, at the end of the Electrical integration tests.

Details have been discussed during the data management working group n° 29.
This test execution will be under responsibility of AAS-I (responsible of the OBSM tool).

The main step of the procedure for this test is, for each patchable memory area :

- 1- to upload a small patch to an unused memory area, in RAM, then in EEPROM, if applicable
- 2- to dump the areas and verify correct patching
- 3- remove patch
- 4- to upload a large patch in RAM, if applicable
- 5- to dump the area and verify correct patching
- 6- to upload full new TBD SW in EEPROM
- 7- to dump the area and verify correct patching
- 8- to reload the original SW versions
- 9- to dump the area and verify correct patching (*)

(*) The OBSM tool dumps only the area that has been patched. The integrity of the memory is verified by checksum.

Based on the above, each instrument is therefore requested to :

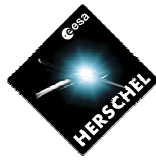

- provide patch procedures in each case (ie. define the mode in which the instrument shall be in each patch case and provide the relevant TC's+TM
- provide the different patch files in ESOC IMG format, ref SCOS 2000 OBSM external ICD, AD-7)
- attend the test (considered mandatory)

4.4.3 UFT (Unit Functional Test)/ SIT (Subsystem Integration Test)

UFT

During the integration sequence, all units having no direct interface to the SVM, are to be connected usually to the DPU via WIH (data link and/or Secondary Power).

The sequence shall be such that the warm units are connected one by one, and a sequence is run to check that the unit get the power, and is able to communicate with the DPU

SIT

After completion of the instruments warm units electrical integration, a global test on instrument warm units has to be performed to verify that the instruments warm units, as a subsystem, are operational, and ready to execute further tests. This is the SIT. It is usually a full warm functional test of the instrument.

To simplify the sequence, if the integration sequence has been performed many times at ILT without problems, instruments have the possibility to connect all instruments WU with WIH, and run only the SIT at the end.

The UFT/IST sequence have been elaborated by instruments teams with the aim to be common for AVM and for FM. This has been achieved for PACS & SPIRE, not for HIFI (due to the very simple configuration on AVM).

4.4.3.1 Instruments UFT/SIT for AVM

4.4.3.1.1 HIFI AVM:

The ICU SFT will be executed to verify the integrity of HIFI AVM.

The procedure is given by:

AD-64 - HIFI ICU AVM SFT – TBW (ref mail from L.Dubbedam, 13/09/06)

4.4.3.1.2 SPIRE AVM:

Same procedure than for FM, but limited to nominal Instrument.

The procedure to use for SPIRE AVM UFT/SIT is:

AD-61 - SPIRE-RAL-PRC-002680_1.0 - SPIRE WU Integration Test Procedure.

The sequence to be run on SPIRE AVM in the following:

Step #	Procedure Name	Purpose	Duration
1	SPIRE-WU-INT-DPU-ON-P	DPU Power up and OBS start	5 min
2	SPIRE-WU-INT-DRCU-ON-P	DRCU Power up	5 min
3	SPIRE-WU-INT-SCU-01-P	SCU Low Speed Link check	5 min
4	SPIRE-WU-INT-SCU-02-P	SCU High Speed Link check	5 min



Step #	Procedure Name	Purpose	Duration
5	SPIRE-WU-INT-MCU-01-P	MCU Low Speed Link check	5 min
6	SPIRE-WU-INT-MCU-02-P	MCU High Speed Link check	5 min
7	SPIRE-WU-INT-DCU-01-P	DCU Low Speed Link check	5 min
8	SPIRE-WU-INT-DCU-02-P	DCU High Speed Link check	5 min
9	SPIRE-WU-INT-MCU-OFF-P	MCU power off	5 min
10	SPIRE-WU-INT-DRCU-OFF-P	DRCU power off	5 min
11	SPIRE-WU-INT-DPU-OFF-P	DPU power off	5 min

4.4.3.1.3 PACS AVM:

Same procedure than for FM, but limited to nominal Instrument.

The procedure to use for PACS AVM UFT is:

AD-62 - PACS-ME-TP-016_1_4 - Test Procedure for PACS Warm Electronics Tests

The sequence to be run is in section 11.3 (nominal chain only).

It is similar to the incoming inspection test, but the command / Powering is performed from the CCS, through the SVM CDMU/PCDU.

The sequence is the following:

Test with PACS WU connected to SVM & CCS	Duration
Switch-on (Nominal)	0:06:00
Simulated Spectroscopy Mode	
Simulated Photometry mode	
Enter SAFE mode	0:06:00
Switch off	

4.4.3.2 Instruments UFT/SIT for FM

4.4.3.2.1 SPIRE FM UFT:

The procedure to use for SPIRE FM UFT is:

AD-61 - SPIRE-RAL-PRC-002680_1.0 - SPIRE WU Integration Test Procedure

The sequence to be run on SPIRE FM in the following:

Step #	Procedure Name	Purpose	Duration
1	SPIRE-WU-INT-DPU-ON-P	DPU Power up and OBS start	5 min
2	SPIRE-WU-INT-DRCU-ON-P	DRCU Power up	5 min
3	SPIRE-WU-INT-SCU-01-P	SCU Low Speed Link check	5 min
4	SPIRE-WU-INT-SCU-02-P	SCU High Speed Link check	5 min
5	SPIRE-WU-INT-MCU-01-P	MCU Low Speed Link check	5 min
6	SPIRE-WU-INT-MCU-02-P	MCU High Speed Link check	5 min
7	SPIRE-WU-INT-DCU-01-P	DCU Low Speed Link check	5 min
8	SPIRE-WU-INT-DCU-02-P	DCU High Speed Link check	5 min
9	SPIRE-WU-INT-MCU-OFF-P	MCU power off	5 min
10	SPIRE-WU-INT-DRCU-OFF-P	DRCU power off	5 min
11	SPIRE-WU-INT-DPU-OFF-P	DPU power off	5 min

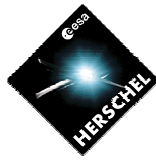

Step #	Procedure Name	Purpose	Duration
12	Change 1553 Spacecraft bus from SPIRE DPU PRIME to SPIRE DPU REDUNDANT.		unknown
13	Change to SPIRE Redundant MIB on the CCS (If applicable)		
14	SPIRE-WU-INT-DPU-ON-R	DPU Power up and OBS start	5 min
15	SPIRE-WU-INT-DRCU-ON-R	DRCU Power up	5 min
16	SPIRE-WU-INT-SCU-01-R	SCU Low Speed Link check	5 min
17	SPIRE-WU-INT-SCU-02-R	SCU High Speed Link check	5 min
18	SPIRE-WU-INT-MCU-01-R	MCU Low Speed Link check	5 min
19	SPIRE-WU-INT-MCU-02-R	MCU High Speed Link check	5 min
20	SPIRE-WU-INT-DCU-01-R	DCU Low Speed Link check	5 min
21	SPIRE-WU-INT-DCU-02-R	DCU High Speed Link check	5 min
22	SPIRE-WU-INT-MCU-OFF-R	MCU power off	5 min
23	SPIRE-WU-INT-DRCU-OFF-R	DRCU power off	5 min
24	SPIRE-WU-INT-DPU-OFF-R	DPU power off	5 min

Total: ~ 120 min

4.4.3.2.2 PACS FM UFT:

The procedure to use for PACS FM UFT is:

AD-62 - PACS-ME-TP-016_1_4 - Test Procedure for PACS Warm Electronics Tests

The sequences to be run are in section 11.3 (nominal), and 11.4 (redundant)

It is similar to the incoming inspection test, but the command / Powering is performed from the CCS, through the SVM CDMU/PCDU.

The sequence is the following:

Test with PACS WU connected to SVM & CCS	Duration
Switch-on (Nominal)	0:06:00
Simulated Spectroscopy Mode	
Simulated Photometry mode	
Enter SAFE mode	0:06:00
Switch off	

Test with PACS WU connected to SVM & CCS	Duration
Switch-on (Redundant)	0:06:00
Simulated Spectroscopy Mode	
Simulated Photometry mode	
Enter SAFE mode	0:06:00
Switch off	

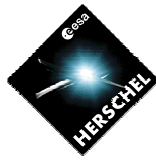

4.4.3.2.3 *HIFI FM UFT/SIT.*

The procedure to use for HIFI FM UFT is:

[AD-65 – SRON-G/HIFI/PR/2006-0xx - HIFI FM Integration & Functional procedures](#)

Activity	Duration
HIFI SFT (Warm with LOU & FPU)	1:00:00
Switch-on HIFI (= OFF -> SAFE transition)	0:10:00
ICU SFT	0:40:00
HRS SFT	
WBS SFT	
FP SFT (all bands)	
LO SFT (all bands)	
SFT on redundant FCU, ICU	
Standby / Shut Down	0:10:00

The sequence is to be repeated on redundant Instrument.

4.5 SFT (Short Functional tests)

SFT (short functional tests) is a test sequence (short, as indicated by the name), aimed to verify the health check of the instrument.

This test will be performed at various stage of the satellite integration and test:

- During the integration of the FPU, prior to close the CVV upper bulkhead (SWT warm)
- After cooldown, to verify that the FPU has all its connections (SFT cold (He I or He II))
- Before and after any environment test: EMC, Vibration, and TV test.
- Before the IST

The SFT should be able to be run (as far as possible) by Industry AIT team only, and preferably without using the I-EGSE. (to avoid multiple transfer of instrument teams). This can be done either by training (during the first SFT), or by a proper diagnostic included in the SFT test scripts (for each test step, a visual statement OK or NOK).

4.5.1 PACS SFT

The test procedure to be used for PACS SFT is:

AD-74 - PACS-ME-TP-017_1.5 - SFTs test procedures – TBW

The sequence is similar for warm and cold conditions. Only the parameters to be checked need to be adapted to the FPU temperature.

Overview of PACS Short Functional Tests

PACS nominal or Redundant SFT (warm, HeI, He II)	duration
SFT PACS nominal SFT (warm, HeI, He II)	1:12:00

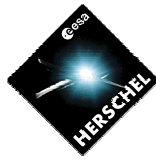

PACS nominal or Redundant SFT (warm, Hel, He II)		duration
	Switch-on PACS Nominal (= OFF – SAFE transition)	
	Basic chopper moves	
	Optional laun-chlock open / close steps	
	Open loop / closed loop simple grating moves	
	Calibration sources, simple check (no stabilisation)	
	Heater/Flashers: simple check of currents (new)	
	Filter wheel Phot: 3 full turns	
	Filter wheel Spec: 3 full turns	
	T Sensors: plausibility check	
	Ge:Ga detector chain: mainly dummy resistor check	
	Cooler: check if heater currents can be applied (T response)	
	Bolometer detector chain: bias staircase pattern	
	Configure PACS to nonPrime	
	Switchoff	

This sequence is to be repeated for the redundant chain.

4.5.2 SPIRE SFT

The test procedure to be used for SPIRE SFT is:

AD-71 - SPIRE-RAL-PRC-002494_2.0 – SPIRE Short Functional Test Procedures

The test sequence is the following (duration 1:00)

step	Activity / Script	Purpose
01	SPIRE-IST-DPU-ON	
02	SPIRE-IST-DRCU-ON	
03	SPIRE-IST-FUNC-SCU-01	
04	SPIRE-IST-FUNC-SCU-03	
05	SPIRE-IST-FUNC-SCU-06	
06	SPIRE-IST-FUNC-SCU-07	
07	SPIRE-IST-FUNC-SCU-04	
08	SPIRE-IST-FUNC-SCU-05	
09	SPIRE-IST-FUNC-MCU-01	
10	SPIRE-IST-FUNC-MCU-02	
11	SPIRE-IST-FUNC-BSM-01	
12	SPIRE-IST-BSM-OFF	
13	SPIRE-IST-FUNC-SMEC-01	
14	SPIRE-IST-SMEC-OFF....	
15	SPIRE-IST-FUNC-DCU-01.	
16	SPIRE-IST-FUNC-DCU-04-P	
17	SPIRE-IST-PLIA-OFF	
18	SPIRE-IST-FUNC-DCU-04-S	
19	SPIRE-IST-SLIA-OFF	
20	SPIRE-IST-MCU-OFF	
21	SPIRE-IST-SCU-OFF	
22	SPIRE-IST-DRCU-OFF	
23	SPIRE-IST-DPU-OFF	

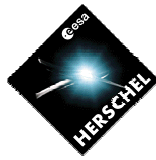

The sequence is to be repeated for the Redundant Instrument.

4.5.3 HIFI SFT

HIFI SFT is similar to HIFI UFT

The procedure to use for HIFI FM SFT is:
AD-75 – HIFI SFT - TBW

Activity		Duration
HIFI SFT (Warm with LOU & FPU)		1:00:00
	Switch-on HIFI (= OFF -> SAFE transition)	0:10:00
	ICU SFT	0:40:00
	HRS SFT	
	WBS SFT	
	FP SFT (all bands)	
	LO SFT (all bands)	
SFT on redundant FCU, ICU		
	Standby / Shut Down	0:10:00

The sequence is to be repeated on redundant part of the Instrument.

4.6 IST (Integrated System Test)

4.6.1 IST overall description

Integrated System test is a satellite level verification, aimed to verify in an accelerated manner the main satellite functions that will be used during launch , commissioning, and operation. The IST will be performed 2 times: before (IST1) and after (IST2) the satellite environment tests.

A short summary of the IST is given here. For more details, refer to
AD-21 – Herschel IST test specification - H-P-2-ASP-SP-0939_2.0.

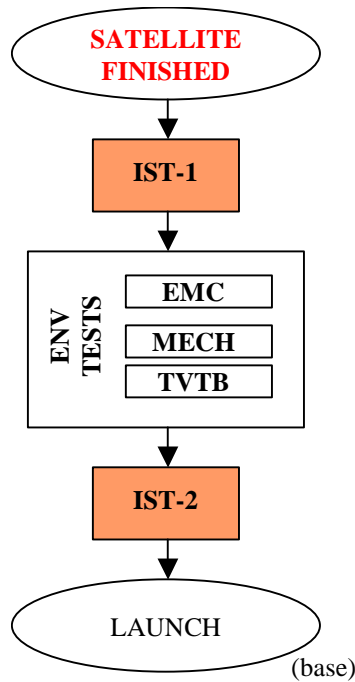
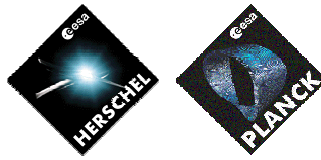

The complete IST sequence is summarized on the following figure:

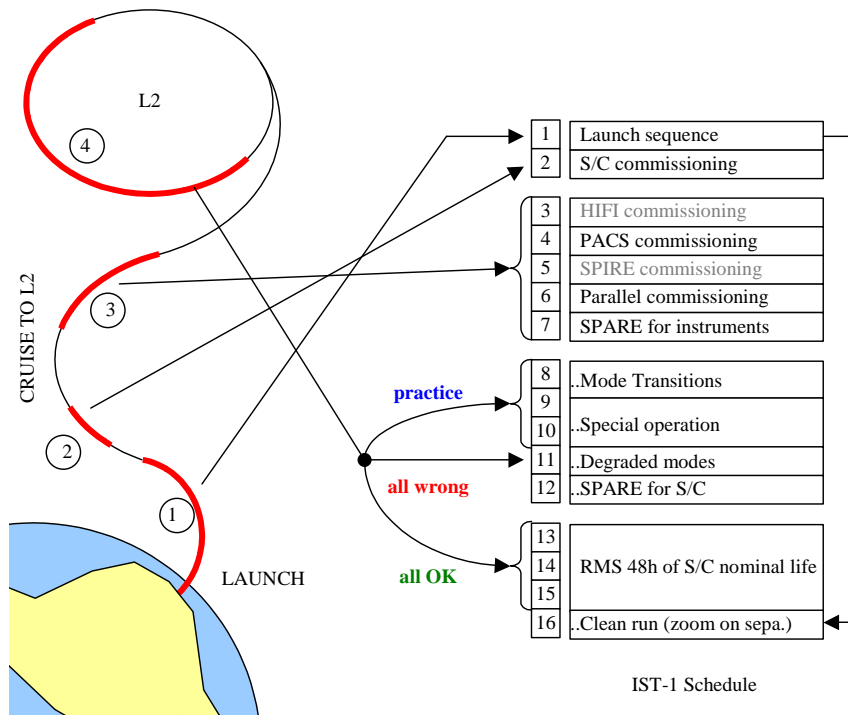

The following table (from AD21) is a summary of the IST, and give instrument usage and time scales. (A/B units are related to Nominal/Redundant).

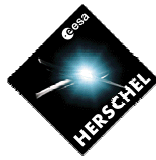

Set	Day	Units	PM			HIFI	PACS	SPIRE	//
BEFORE IST	1	AB	AB	Health check Non regression tests	Spacecraft UFT	none	none	none	none
	2	AB	AB		Instrument UFT	1h	1h	1h	n/a
1	1	A	A	Launch sequence	Launch simulation	none	none	none	none
	2	AB	AB	S/C commissioning	Commissioning procedure exercise	none	none	none	none
2	1	A	A	Instrument commissioning and performance verification	HIFI	8h	STBY	STBY	n/a
	2	A	B		PACS	STBY	8h	STBY	n/a
	3	B	A	Instrument commissioning and performance verification	SPIRE	STBY	STBY	8h	n/a
	4	B	B		PARALLEL mode	STBY	3h	3h	3h
	5			SPARE	(reserved for instrument operation)				
3	1	AB	AB	Mode transitions	Transition with instrument emergency STBY or stop	1h	1h	1h	1h
	2	B	B		S/C reconfiguration (level 4, DoD)				
	3	A	A	Special operation cases	MTL management	1h	1h	1h	
		B	B		DTCP worst case operational scenario		3h	3h	
	4	A	B	Degraded cases	Launch sequence robustness				
		B	A		NOM mode robustness	< 1h	< 1h	< 1h	
5			SPARE	(reserved for satellite operation)					
4	1			48h endurance test 27h autonomy test	Endurance exercise	16h	15h	15h	2h
	2	A	A						
	3								
	4	A	A	Launch clean run	(need full satellite connection reconfiguration)	none	none	none	none

Instruments will be mainly involved in the commissioning phase, and in the Reference Mission scenario (described in AD 14 & AD 11).

Special Performance Test (SPT) will be executed for each instrument after the IST (see below).

Commissioning phase objective is to verify the S/C ability to support the instrument commissioning and performance verification operations.

So instruments have to prepare typical sequences that will be used during this phase, compacted to fit in the 8h allocated per instrument.

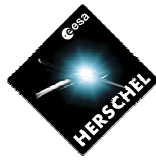

Commissioning phase sequence can be build with standard test scripts to generate the TC's (no MTL)

The objective of the **Reference Mission Scenario** is to test the satellite during its nominal long term operation, especially comprising the scientific instruments operations.

It is organised around the Reference Mission Scenario (AD14) which defines the activities to be carried out during a typical operational day.

It will be a 48h continuous operation, controlled by mission timeline (MTL=time tagged sequences). Each instrument will be allocated 14h simulated observation, separated by Slots of 3h DTCP simulation (Daily Tele-Communication Phase, including coolers recycling)). Inside this phase, instruments are free to prepare sequence using various observation modes.

The satellite will be horizontal, to allow cooler recycling and SPIRE spectrometer mode without moving during the test.

PACS will be used shortly at the beginning, in burst mode to fill the system memory for DTCP1.

Then the sequence is the following.

- PACS Prime / Burst Mode (30mn)
- DTCP1: Switch PACS to HIFI (3h)
- HIFI Prime (include peak-up) (14h)
- DTCP2 : Switch HIFI to PACS + PACS cooler recycle (3h)
- PACS Prime (14h)
- DTCP3 : Switch PACS to SPIRE + SPIRE cooler recycle (3h)
- SPIRE Prime (include peak-up) (14h)
- DTCP4 : Switch SPIRE to HIFI cooler recycle (3h)
- HIFI Prime (30mn)

The detailed sequence of RMS is given in table of next section 4.6.6, and section 5.8.9.3 of AD 21.

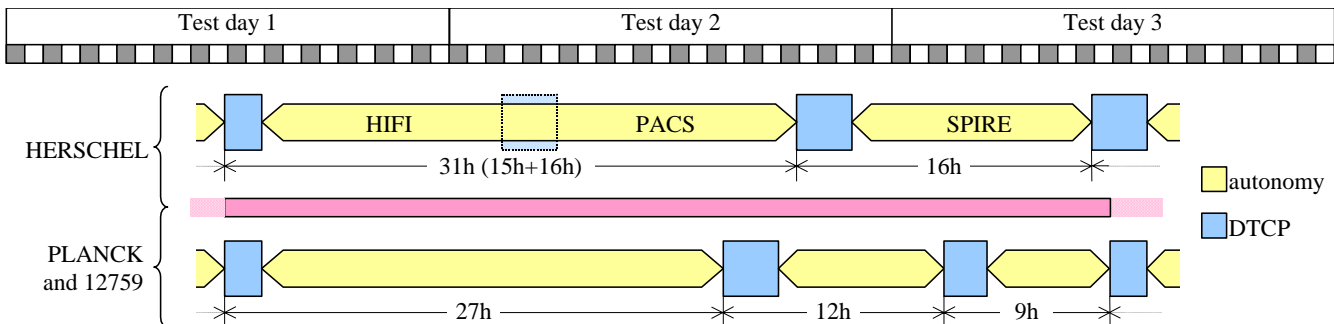

The **Special Performance Test** (SPT) includes any sequence that the instrument wish to test during this phase, and that cannot fit in the Commissioning of RMS, either because of the limited time slot, or because it would not fit with the objective.

About 3 days (long days 10:00) are allocated for each instruments for SPT.

For Commissioning, RMS, and SPT phases, instrument shall provide dedicated test procedures.

For the RMS, the test sequence shall be time tagged, ie shall be given in AOT (Astronomical Observation Templates). The translation from AOT to MTL will be performed by ESOC.

(references to ESOC specifications to Instruments to generate MTL from AOT to be included here)

The test sequences to be performed on instruments during the IST are defined in the next sections. During all IST, when one instrument is prime, the other are in Standby mode (and not OFF)



For AVM, only the commissioning and RMS part of the IST will be run (No SPT).
For SPIRE and PACS, the same IST procedure can be run on both AVM and FM
For HIFI, dedicated AVM IST procedure shall be written for the ICU (AD-88).

4.6.2 PACS IST

The procedure to be used for PACS IST is the following:

AD81 – PACS-ME-TP-021_tbd - PACS IST procedures - TBW

This procedure can be run both for AVM and for FM, and includes the 3 sub-sequences: Commissioning, RMS, and SPT (Only SPT is not used on AVM)

PACS IST Sequence:

4.6.2.1 PACS Commissioning:

(to be used AVM & FM)

PACS Commissioning		duration	Time	from cooker recycling
1: PACS Full Functional Test (FFT) at Hell conditions		10:36:00		
	Switch-on (OFF – SAFE Transition)	0:06:00	0:06:00	
	Memory Management Test	0:06:00	0:12:00	
	SetupSpectroscopyCSoff (+Llock open)	0:18:00	0:30:00	
	Grating Test	0:12:00	0:42:00	
	Thermal behaviour SPEC	1:30:00	2:12:00	
	Ge:Ga heater	0:18:00	2:30:00	
	Ge:Ga flasher	0:15:00	2:45:00	
	Setup Spectroscopy, FW SPEC, data rates and background adjustment	2:00:00	4:45:00	
	Chopper full FoV move	0:18:00	5:03:00	
	Medium sampling grating scan (2 filters)	1:00:00	6:03:00	
	Cooler recycling	2:12:00	8:15:00	2:12:00
	Thermal behaviour PHOT	1:30:00	9:45:00	3:42:00
	Setup Photometry, FW PHOT, data rates	0:36:00	10:21:00	4:18:00
	Bolometers saturation check	0:06:00	10:27:00	4:24:00
	Enter Safe Mode	0:02:00	10:29:00	4:26:00
	Configure PACS to nonPrime	0:05:00	10:34:00	4:31:00
	Switchoff	0:02:00	10:36:00	4:33:00

4.6.2.2 PACS RMS

(To be used on AVM & FM)

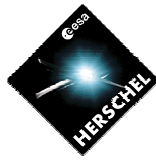

PACS Reference Mission Scenario	Duration	Time	Time from cooler recycling
	15:58:00		
Switch ON, Configure PACS to Prime	0:06:00	0:06:00	
Cooler Recycling	2:12:00	2:18:00	2:12:00
One Hour DTCP With PACS ON (starts with cooler recycling)	0:00:00	0:06:00	2:12:00
Spectroscopy Set Up	0:45:00	0:51:00	2:57:00
Window to Schedule AOT, or observation in Spectroscopy	4:00:00	4:51:00	6:57:00
Detector Curing	0:30:00	5:21:00	7:27:00
Window to Schedule AOT, or observation in Spectroscopy	3:30:00	8:51:00	10:57:00
Enter Safe Mode	0:02:00	8:53:00	10:59:00
Photometry Set Up	0:45:00	3:03:00	11:44:00
Window to Schedule AOT, or observation in Photometry	3:00:00	6:03:00	14:44:00
Enter Safe Mode	0:02:00	6:05:00	14:46:00
Configure PACS to nonPrime	0:05:00	6:10:00	14:51:00
One Hour DTCP With PACS ON	1:00:00	7:10:00	15:51:00
Switchoff	0:01:00	6:11:00	15:52:00

4.6.2.3 PACS SPT

(To be used on FM Only)

PACS Special Performance Test	Duration	Time	Time from cooler recycle
Total duration	23:15:00		
Short Performance Test at HeII, SPEC	8:23:00		
Switchon (OFF to SAFE Transition)	0:06:00	0:06:00	
Memory Management Test	0:00:00	0:06:00	
SetupSpectroscopy CS off (+Llock open)	0:00:00	0:06:00	
Ge:Ga dark currents on internal CSs (cold)	0:39:00	0:45:00	
Grating performance test (full diagnostic monitoring, exploration of stepping performances on full accessible range)	0:33:00	1:18:00	
Chopper performance test (duty cycle at different frequencies, OBCP sync.)	0:12:00	1:30:00	
Emissivity of internal CSs	0:45:00	2:15:00	
Quick Wavelength check	0:18:00	2:33:00	
Grating RSRF	3:06:00	5:39:00	
S/N as function of reset interval	0:15:00	5:54:00	
Different bias settings for Ge:Ga detectors	0:18:00	6:12:00	
Test of internal calibration recipes SPEC	0:00:00	6:12:00	
Time constants for flux changes spectroscopy	0:30:00	6:42:00	
Internal CSs performance test	1:06:00	7:48:00	
Detector selection table test SPEC	0:18:00	8:06:00	
SPU compression/reduction test	0:15:00	8:21:00	
Enter Safe Mode	0:02:00	8:23:00	



PACS Special Performance Test		Duration	Time	Time from cooler recycle
Short Performance Test at HeII, PHOT		6:40:00		
	Cooler recycling	2:12:00	10:35:00	2:12
	SetupPhotometry	0:36:00	11:11:00	2:48
	Test of internal calibration recipes PHOT	0:36:00	11:47:00	3:24
	Focal plane map with CSs and representative background (updated see HP2ASEDSD0064)	0:42:00	12:29:00	4:06
	Staring measurement on CS for low frequency noise	1:30:00	13:59:00	5:36
	Time constants for flux changes photometry	0:30:00	14:29:00	6:06
	Detector selection table test PHOT	0:06:00	14:35:00	6:12
	SPU compression/reduction test PHOT	0:15:00	14:50:00	6:27
	Test pattern photometry	0:06:00	14:56:00	6:33
	Enter Safe Mode	0:02:00	14:58:00	6:35
	Configure PACS to nonPrime	0:05:00	15:03:00	6:40
AOT Tests (Astronomical Observation template):		8:12:00		
	Switchon (Nominal)	0:06:00	16:20:00	11:34
	Cooler recycling	2:12:00	18:32:00	13:46
	SetupPhotometry	0:36:00	19:08:00	14:22
	"TuttiFrutti" AOT test PHOT	0:30:00	19:38:00	14:52
	PHOT AOT concepts (based on lessons learnt: EQM IMT, FM ILT)	1:00:00	20:38:00	15:52
	Enter SAFE mode	0:06:00	20:44:00	15:58
	SetupSpectroscopy	0:36:00	21:20:00	16:34
	"TuttiFrutti" AOT test SPEC	0:30:00	21:50:00	17:04
	SPEC AOT concepts (based on lessons learnt: EQM IMT, FM ILT)	2:00:00	23:50:00	19:04
	Ge:Ga detector curing procedure	0:30:00	24:20:00	17:04
	Enter SAFE mode	0:06:00	24:26:00	17:10
	Switch off (redundant)	0:00:00	24:26:00	17:10
Test of redundant PACS instrument: (new for FM)		4:48:00		
	Switchon (redundant)	0:06:00	15:02:00	6:46
	Cooler recycling	2:12:00	17:14:00	8:58
	SetupPhotometry (other controller params !)	0:36:00	17:50:00	9:34
	Two/Three position chopping w/wo CSs	0:30:00	15:32:00	10:04
	Enter SAFE mode	0:06:00	15:38:00	10:10
	SetupSpectroscopy (other controller params!)	0:36:00	16:14:00	10:46
	Line scan AOT with variation of internal calibration concept	0:36:00	16:08:00	11:22
	Enter SAFE mode	0:06:00	16:14:00	11:28
	Switch off (redundant)	0:00:00	16:14:00	11:28

4.6.3 SPIRE IST

4.6.3.1 SPIRE Commissioning

For FM SPIRE commissioning, the SPIRE Cold Functional test will be run.

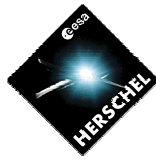

The test procedure is the following (for AVM and FM):
AD-82 - SPIRE-RAL-PRC-002398_2.0 – SPIRE Cold Functional Test Procedures

The test sequence proposed by SPIRE is the following:

STEP	Procedure	Purpose
01	Procedure SPIRE-IST-DPU-ON	
02	Procedure SPIRE-IST-DRCU-ON	
03	Procedure SPIRE-IST-FUNC-SCU-02	
04	Procedure SPIRE-IST-FUNC-SCU-03	
05	Procedure SPIRE-IST-FUNC-SCU-06	
06	Procedure SPIRE-IST-FUNC-SCU-07	
07	Procedure SPIRE-IST-FUNC-SCU-04	
08	Procedure SPIRE-IST-FUNC-PCAL-01	
09	Procedure SPIRE-IST-FUNC-SCU-05	
10	Procedure SPIRE-IST-FUNC-SCAL-01	
11	Procedure SPIRE-IST-FUNC-MCU-01	
12	Procedure SPIRE-IST-FUNC-MCU-03	
13	Procedure SPIRE-IST-FUNC-BSM-01	
14	Procedure SPIRE-IST-FUNC-BSM-03	
15	Procedure SPIRE-IST-FUNC-BSM-05a	
16	Procedure SPIRE-IST-FUNC-BSM-05b	
17	Procedure SPIRE-IST-BSM-OFF	
18	Procedure SPIRE-IST-FUNC-SMEC-02a	
19	Procedure SPIRE-IST-FUNC-SMEC-01	
20	Procedure SPIRE-IST-FUNC-SMEC-03	
21	Procedure SPIRE-IST-FUNC-SMEC-04a	
22	Procedure SPIRE-IST-FUNC-SMEC-09	
23	Procedure SPIRE-IST-FUNC-SMEC-04b	
24	Procedure SPIRE-IST-FUNC-SMEC-07	
25	Procedure SPIRE-IST-FUNC-SMEC-06	
26	Procedure SPIRE-IST-SMEC-OFF	
27	Procedure SPIRE-IST-FUNC-SMEC-02b	
28	Procedure SPIRE-IST-FUNC-DCU-01	
29	Procedure SPIRE-IST-FUNC-DCU-11-P	
30	Procedure SPIRE-IST-FUNC-DCU-13-P	
31	Procedure SPIRE-IST-PDET-OFF	
32	Procedure SPIRE-IST-FUNC-DCU-11-S	
33	Procedure SPIRE-IST-FUNC-DCU-13-S	
34	Procedure SPIRE-IST-SDET-OFF	
35	Procedure SPIRE-IST-MCU-OFF	
36	Procedure SPIRE-IST-SCU-OFF	
37	Procedure SPIRE-IST-DRCU-OFF	
38	Procedure SPIRE-IST-DPU-OFF	

4.6.3.2 SPIRE RMS

The SPIRE Reference Mission Scenario procedure is the following (for both AVM and FM):
AD-84 - SPIRE-RAL-PRC-00xxxx_xx – SPIRE Reference Mission Scenario Procedure (TBW)

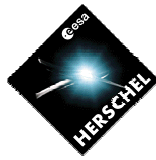

The sequence proposed by SPIRE to be run during the RMS is:

SPIRE Reference Mission Scenario (RMS) (14 hours allocated to SPIRE)		Duration	Time	Time from cooler recycle
		13:20:00		
Cooler recycle test		3:00:00		
	SPIRE Cooler recycle (automatic)		0:00:00	
	Automatic cooler recycle CREC	2:00:00	2:00:00	0:00:00
	Wait for stable temperature conditions	1:00:00	3:00:00	1:00:00
Photometer mode tests		4:10:00		
	Photometer scan mode POF5	2:00:00	5:00:00	3:00:00
	Photometer chop/jiggle mode POF2	2:00:00	7:00:00	5:00:00
	Switch to SPECSTBY	0:10:00	7:10:00	5:10:00
Spectrometer Mode Test		6:10:00		
	Switch to SPEC high resolution mode SOF1	0:10:00	7:20:00	5:20:00
Spectrometer Mode Test SOF1 part 1		1:00:00	8:20:00	6:20:00
	Switch to spectrometer high resolution mode SCAL null check	0:00:00	8:20:00	6:20:00
	Set SCAL temperature incrementally to null background from cryocover	2:00:00	10:20:00	8:20:00
Spectrometer Mode Test SOF1 part 2		1:00:00	11:20:00	9:20:00
	Switch to spectrometer high resolution mode SCAL null check	0:00:00	11:20:00	9:20:00
	Set SCAL temperature incrementally to null background from cryocover	2:00:00	13:20:00	11:20:00

4.6.3.3 SPIRE SPT

SPIRE SPT procedure is the following (for SPIRE FM Only):

AD-85 - SPIRE-RAL-PRC-002704_1.0 - SPIRE Special Performance Test Procedures

The test sequence proposed by SPIRE during the SPT is the following:

SPIRE Special Performance Test (SPT/IMT) during IST1 (3 days)		Duration	Time	Time from cooler recycling
Total		40:40:00		
Cooler recycle test		3:00:00		
	SPIRE Cooler recycle (automatic)	0:00:00	0:00:00	
	Automatic cooler recycle CREC	2:00:00	2:00:00	0:00:00
	Wait for stable temperature conditions	1:00:00	3:00:00	1:00:00
Spectrometer Ambient background verification test		4:10:00		
	Switch to SPEC STBY	0:10:00	3:10:00	1:10:00
	Carry out dark ambient background verification ABVS part 1	2:00:00	5:10:00	3:10:00
	Carry out dark ambient background verification ABVS part 2	2:00:00	7:10:00	5:10:00
Photometer Ambient Background verification test		3:10:00		



SPIRE Special Performance Test (SPT/IMT) during IST1 (3 days)		Duration	Time	Time from cooler recycling
	Switch to PHOTSTBY	0:10:00	7:20:00	5:20:00
	Carry out dark ambient background verification ABVP part 1	1:00:00	8:20:00	6:20:00
	Carry out dark ambient background verification ABVP part 2	2:00:00	10:20:00	8:20:00
	Overnight noise tests PHOT STBY		10:20:00	8:20:00
Night		13:40:00		22:00:00
Cooler recycle test		3:00:00		
	SPIRE Cooler recycle (automatic)	0:00:00	0:00:00	
	Automatic cooler recycle CREC	2:00:00	2:00:00	0:00:00
	Wait for stable temperature conditions	1:00:00	3:00:00	1:00:00
Photometer mode tests		4:10:00		
	Photometer scan mode POF5	2:00:00	5:00:00	3:00:00
	Photometer chop/jiggle mode POF2	2:00:00	7:00:00	5:00:00
	Switch to SPECSTBY	0:10:00	7:10:00	5:10:00
Spectrometer Mode Test		3:20:00		
	Switch to SPEC high resolution mode SOF1	0:10:00	7:20:00	5:20:00
	Spectrometer Mode Test SOF1 part 1	1:00:00	8:20:00	6:20:00
	Switch to spectrometer high resolution mode SCAL null check	0:00:00	8:20:00	6:20:00
	Set SCAL temperature incrementally to null background from cryocover	2:00:00	10:20:00	8:20:00
	Switch to SPEC STBY (for overnight noise tests)	0:10:00	10:30:00	8:30:00
	Overnight noise tests SPEC STBY		10:30:00	8:30:00
Night		13:30:00		22:00:00
Cooler recycle test		3:00:00		
	SPIRE Cooler recycle (automatic)	0:00:00	0:00:00	
	Automatic cooler recycle CREC	2:00:00	2:00:00	0:00:00
	Wait for stable temperature conditions	1:00:00	3:00:00	1:00:00
Spectrometer Mode Test		3:20:00		
	Switch to SPEC high resolution mode SOF1	0:10:00	3:10:00	1:10:00
	Spectrometer Mode Test SOF1 part 2	1:00:00	4:10:00	2:10:00
	Switch to SPEC STBY	0:10:00	4:20:00	2:20:00
	Switch to spectrometer high resolution mode SCAL null check	0:00:00	4:20:00	2:20:00
	Set SCAL temperature incrementally to null background from cryocover	2:00:00	6:20:00	4:20:00
Spectrometer Microvibration Test		4:00:00		
	Spectrometer Microvibration Test	4:00:00	10:20:00	8:20:00
	Continuous SPEC high resolution mode while reaction wheels are exercised MICV		10:20:00	8:20:00
Spectrometer to Photometer Mode Switch		1:20:00		
	Switch from SPEC STBY to PHOT STBY	0:20:00	10:40:00	8:40:00
	Wait for temperatures to stabilise	1:00:00	11:40:00	9:40:00
Photometer Thermal Control Verification		4:10:00		
	Carry out photometer thermal control characterisation test PTCV	4:00:00	15:40:00	13:40:00
	Switch to Photometer STBY	0:10:00	15:50:00	13:50:00
300-mK System - Decontamination Test		4:00:00		
	Carry out cooler recycling with both heat switches OFF	4:00:00	19:50:00	17:50:00
SPIRE in STBY TBC during PACS tests		0:00:00		



4.6.4 HIFI IST

The HIFI test procedure for IST are:

For FM

AD-87 – HIFI FM IST procedures – TBW

For AVM

AD-88 – HIFI AVM IST Procedures - TBW

4.6.4.1 HIFI Commissioning

The proposed sequence for HIFI commissioning is the following:

HIFI Commissioning Reduced		Duration	Time
HIFI SFT, SS FT, HIFI FT and reduced VSPT. With FPU at He II & warm units/LOU at room T		8:42:00	
Functional tests HFI Subsystems		2:12:00	
Switch-on HIFI (= OFF → SAFE transition)		0:10:00	0:10:00
ICU SFT & ICU FT		0:05:00	0:15:00
FPU SFT & FP FT on Band 0		0:05:00	0:20:00
HRS SFT & HRS FT		0:30:00	0:50:00
WBS SFT & WBS FT		0:50:00	1:40:00
FP SFT (all bands)		0:15:00	1:55:00
LO SFT & LO FT (all bands)		0:15:00	2:10:00
Chopper scan fast (yes or not ?)		0:02:00	2:12:00
SFT & HIFI FT Sub-band Ia		1:35:00	
SFT Sub-band Ia		0:05:00	0:05:00
LO stabilisation @ f1 & stabilization measurement		0:30:00	0:35:00
Spectrometer Attenuation Tuning		0:00:00	0:35:00
LO Tune @ f1		0:05:00	0:40:00
Magnet Tune @f1		0:00:00	0:40:00
Diplexer Scan Slow		0:05:00	0:45:00
Chopper Scan Slow		0:10:00	0:55:00
FT Pumped		0:30:00	1:25:00
LCU Stand-By @f1		0:00:00	1:25:00
FT UnPumped		0:10:00	1:35:00
LCU Config Safe @f1		0:00:00	1:35:00
LCU switch off from safe			
Very Short Performance test band Ia		2:45:00	4:20:00
Radiometry at 9 frequencies (f2-f10)		0:50:00	0:50:00
Diplexer Scan Slow in Diplexer bands @ f10		0:05:00	0:55:00
Chopper Scan Slow @ f10		0:10:00	1:05:00
FT Pumped @ f10		0:30:00	1:35:00
LCU Stand-By @f10		0:00:00	1:35:00



HIFI Commissioning Reduced		Duration	Time
	FT unPumped @ f10	0:10:00	1:45:00
	LCU Conf Safe @f10	0:00:00	1:45:00
	LO Tune @ f10	0:00:00	1:45:00
	Magnet tuning @f10	0:00:00	1:45:00
	Stability test @f10	1:00:00	2:45:00
repeat SFT & VSPT at band Vllowb		2:00:00	
	Radiometry at 1 frequencies (f1)	0:05:00	0:05:00
	Diplexer Scan Slow in Diplexer bands @ f1	0:05:00	0:10:00
	Chopper Scan Slow @ f1	0:10:00	0:20:00
	FT Pumped @ f1	0:30:00	0:50:00
	LCU Stand-By @f1	0:00:00	0:50:00
	FT unPumped @ f1	0:10:00	1:00:00
	LCU Conf Safe @f1	0:00:00	1:00:00
	LO Tune @ f1	0:00:00	1:00:00
	Magnet tuning @f1	0:00:00	1:00:00
	Stability test @f1	1:00:00	2:00:00
Standby / Shut Down		0:10:00	

4.6.4.2 HIFI RMS

Sequence still to be proposed by HIFI (AVM & FM). Shall include the peak up mode.

4.6.4.3 HIFI SPT

The Special performance test proposed by HIFI (for FM only) is the following:

SPT: HIFI SFT & Functional test FPU at He II & LOU/WU's at room T	Duration	Time
	30:12:00	
Functional tests HFI Subsystems	02:12:00	
Switch-on HIFI (= OFF -> SAFE transition)	0:10:00	0:10:00
ICU SFT & ICU FT	0:05:00	0:15:00
FPU SFT & FP FT on Band 0	0:05:00	0:20:00
HRS SFT & HRS FT	0:30:00	0:50:00
WBS SFT & WBS FT	0:50:00	1:40:00
FP SFT (all bands)	0:15:00	1:55:00
LO SFT & LO FT (all bands)	0:15:00	2:10:00
Chopper scan fast (yes or not ?)	0:02:00	2:12:00
SFT & HIFI FT Sub-band Ia	2:00:00	
SFT Sub-band Ia	0:05:00	0:05:00
LO stabilisation @ f1 & stabilization measurement	0:55:00	1:00:00
Spectrometer Attenuation Tuning	0:00:00	1:00:00
LO Tune @ f1	0:05:00	1:05:00
Magnet Tune @f1	0:00:00	1:05:00
Diplexer Scan Slow	0:05:00	1:10:00
Chopper Scan Slow	0:10:00	1:20:00
FT Pumped	0:30:00	1:50:00

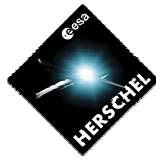

SPT: HIFI SFT & Functional test FPU at He II & LOU/WU's at room T	Duration	Time
LCU Stand-By @f1	0:00:00	1:50:00
FT UnPumped	0:10:00	2:00:00
LCU Config Safe @f1	0:00:00	2:00:00
LCU switch off from safe		
Repeat for other sub-bands 1b, 2a, 2b, 3a, 3b, 4a, 4b, 5a, 5b, 6aL, 6bL, 6aH, 6bH.	26:00:00	28:00:00

4.6.5 PACS-SPIRE parallel mode during IST/Commissioning.

SPIRE & PACS procedure during parallel mode should be covered by both PACS & SPIRE IST procedures AD81 – PACS-ME-TP-021_tbd - PACS IST procedures – TBW (Includes Commissioning, RMS & SPT)

To be used both on AVM & FM.

The test sequence to be run is the following:

SPIRE // PACS mode test during IST	Duration	Time	Time from SPIRE cooler recycle	Time from PACS Cooler recycle
Total time	6:50:00			
PACS Switch ON	0:05:00	0:05:00		
SPIRE Switch to REDY mode from SPEC STBY (or from TBD)	0:10:00	0:15:00		
HIFI switch on in standby non Prime Mode	0:05:00	0:20:00		
CCS Parallele mode 1553	0:00:00	0:20:00		
SPIRE Cooler recycle	2:00:00	2:20:00	0:00:00	
PACS Cooler recycle	0:45:00	3:05:00	0:45:00	0:00:00
SPIRE Set up Photometer (Get parameter from IEGSE)	0:10:00	3:15:00	0:55:00	0:10:00
SPIRE Set the PRIME bias level for all photometer arrays	0:02:00	3:17:00	0:57:00	0:12:00
SPIRE Stop data generation	0:02:00	3:19:00	0:59:00	0:14:00
SPIRE Perform a PCAL Flash	0:02:00	3:21:00	1:01:00	0:16:00
SPIRE Switch to parallel mode Setup for full photometer data sampling at ~10Hz	0:02:00	3:23:00	1:03:00	0:18:00
SPIRE Mark the parallel mode science data with an OBSID	0:02:00	3:25:00	1:05:00	0:20:00
PACS Thermal Behaviour Test in Photometry	1:30:00	4:55:00	2:35:00	1:50:00
PACS Setup Photometry	0:36:00	5:31:00	3:11:00	2:26:00
PACS Single Band Photometry	0:30:00	6:01:00	3:41:00	2:56:00
PACS Dual Band Photometry	0:30:00	6:31:00	4:11:00	3:26:00
SPIRE Switch to CCS handler on I-EGSE	0:06:00	6:37:00	4:17:00	3:32:00
SPIRE End the parallel observation	0:02:00	6:39:00	4:19:00	3:34:00
SPIRE to photometer standby	0:02:00	6:41:00	4:21:00	3:36:00
SPIRE Perform a PCAL Flash	0:02:00	6:43:00	4:23:00	3:38:00
SPIRE Stop data generation	0:02:00	6:45:00	4:25:00	3:40:00
SPIRE to ready from photometer standby	0:02:00	6:47:00	4:27:00	3:42:00
PACS Switch Off	0:01:00	6:48:00	4:28:00	3:43:00
SPIRE Switch OFF	0:01:00	6:49:00	4:29:00	3:44:00
HIFI Switch OFF	0:01:00	6:50:00	4:30:00	3:45:00
		6:50:00	4:30:00	3:45:00



4.6.6 Additional instruments tests during IST

In addition, during satellite IST, instruments will be used also during dedicated satellite tests.

The following table is a summary of the IST sequence given in AD21, and indicate in which sequence the instruments will be used, and which type of operation.

Instruments teams have to identify instruments configuration (existing test scripts), or prepare dedicated test sequences (& scripts) to cover these phases.

These test sequences procedures should be edited in the IST test procedure: IST test reference, Test script to be used, and observations to be made.

- PACS: AD 81
- SPIRE: AD84
- HIFI: AD87.

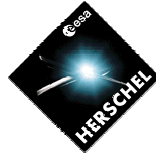

This table highlights the instrument operations in the different steps of the IST test sequences.
The table refers to issue 2.0 of H-P-2-ASP-SP-0939, with some updates presented in red.

	Test step description	action or observed event description			Additional comments	
		>> instrument state (as per "satellite state" table when available in SP-0939)				
		HIFI	PACS	SPIRE		
5.8.2.	Launch phase, separation and post separation activities					
	Activity	none	none	none		
	>>	OFF	OFF	OFF		
5.8.3.	Satellite Commissioning					
5.8.3.5.	CDMS commissioning	1553 data bus commissioning	The DPU/ICU LCL is turned ON. A BOOT SW TM(5,1) shall be receive. A TC(8,4,112,3,auto) is sent. The ASW boot event, then essential and periodic Hk shall be received. The CDMS bus controller setting is modified for using the bus B. A TC(17,1) is sent on bus B. A TM(17,2) shall be received (on bus B). The DPU/ICU LCL is turned OFF.		First intent was just to turn the DPU ON and send a service 17 TC to check the proper 1553 bus operation. But service 17 is not available from BOOT SW, then it is proposed to try the boot command instead.	
5.8.3.7	PCS commissioning		The operation is repeated for all instrument N and R, one at a time. In practice, the CDMS bus controller setting will be not swapped back to bus A between the instrument accesses, and each activation will begin either on bus A or B at random (and finish on the opposite bus).			The turn ON is limited to the DPU, and the activation is limited to a SDB (N/R) communication test.
5.8.4.	Instruments commissioning and performance verification					
5.8.4.5.	SPIRE commissioning test	Instrument in flight commissioning rehearsal	as per instrument specification	as per instrument specification	as per instrument specification	
5.8.4.6.	PACS commissioning test					
5.8.4.7.	HIFI commissioning test					
5.8.4.8.	SPIRE and PACS parallel mode					
5.8.5.	Mode transitions					
5.8.5.8.	NOM to NOM	Preparation	The instrument is turned ON and sets in STBY by GND TC	The instrument turn ON and set in STBY by GND TC. Then it is configured as PRIME in spectrometer mode, and an observation sequence managed from the MTL is started.	The instrument is turned ON and sets in STBY by GND TC	PACS Spectrometer is chosen in order to get a maximum science packet data flow



		Test step description	action or observed event description			Additional comments
			>> instrument state (as per "satellite state" table when available in SP-0939)			
			HIFI	PACS	SPIRE	
		>>	STBY	Spectrometer obs (MTL)	STBY	
		NOM to NOM trs.	no effect	no effect	no effect	
		>>	STBY	Spectrometer obs (MTL)	STBY	
5.8.5.9.	NOM to EAM	NOM to EAM trs.	The OBCP to turn the instrument in STBY is run, which shall only re-enforce the instrument state.	The spectrometer observation conducted from MTL is interrupted by the emergency OBCP, and PACS is set in STBY.	The OBCP to turn the instrument in STBY is run, which shall only re-enforce the instrument state.	Maximum science packet data flow is interrupted.
		>>	STBY	STBY	STBY	
5.8.5.10.	EAM to EAM	Preparation	-	-	SPIRE is set-up as PRIME in photometer mode using GND TC (no MTL)	SPIRE test mode may be entered instead of photometer mode if more suitable. But TM(21,x) emission is interesting to check for any action of the CDMS ASW action at TM management level.
		>>	STBY	STBY	Photometer mode	
		EAM to EAM trs.	The OBCP to turn the instrument in STBY is run, which shall only re-enforce the instrument state.	The OBCP to turn the instrument in STBY is run, which shall only re-enforce the instrument state.	The instrument operation (photometer mode) is interrupted by the emergency OBCP, and SPIRE is set in STBY.	Note activating the instrument in EAM is not nominal, but done here to create an observable for checking the expected actions of CDMS ASW.
		>>	STBY	STBY	STBY	
5.8.5.11.	EAM to NOM	Preparation	-	-	Photometer mode is activated again by GND TC	
		>>	STBY	STBY	Photometer mode	
		EAM to NOM trs.	no effect	no effect	no effect	
		>>	STBY	STBY	Photometer mode	
5.8.5.12.	NOM to SM	Preparation	-	-	An observation sequence from MTL is started.	
		>>	STBY	STBY	Photometer obs (MTL)	



		Test step description	action or observed event description			Additional comments
			>> instrument state (as per "satellite state" table when available in SP-0939)			
			HIFI	PACS	SPIRE	
		NOM to SM trs.	The emergency OBCP to turn OFF the instrument is run.	The emergency OBCP to turn OFF the instrument is run.	The photometer observation from MTL is interrupted by the emergency OFF OBCP, but MTL do not stop to send TC for a while due to specific commanding of the test sequence.	
		>>	OFF	OFF	OFF	
5.8.5.13.	SM to SM	Preparation	The instrument is turned ON and sets in STBY by GND TC	-	-	
		>>	STBY	OFF	OFF	
		SM to SM trs.	HIFI is returned to OFF state by emergency OFF OBCP	The OBCP to turn OFF the instrument in STBY run, which shall do nothing.	The OBCP to turn OFF the instrument in STBY run, which shall do nothing.	
		>>	OFF	OFF	OFF	
5.8.5.14.	SM to SAM	Preparation	The instrument is turned ON and set in STBY by GND TC	-	-	
		>>	STBY	OFF	OFF	
		SM to SAM trs.	no effect	no effect	no effect	
		>>	STBY	OFF	OFF	
5.8.5.15.	SAM to SM	SM to SM trs.	HIFI is returned to OFF state by emergency OFF OBCP	The OBCP to turn OFF the instrument in STBY run, which shall do nothing.	The OBCP to turn OFF the instrument in STBY run, which shall do nothing.	
		>>	OFF	OFF	OFF	
5.8.5.16.	EAM to SM (needs new SM to SAM, SAM to NOM and NOM to EAM)	Preparation	The instrument is turned ON and sets in STBY by GND TC	-	-	
		>>	STBY	OFF	OFF	
		SM to SAM trs.	no effect	no effect	no effect	



Test step description	action or observed event description			Additional comments
	>> instrument state (as per "satellite state" table when available in SP-0939)			
	HIFI	PACS	SPIRE	
>>	STBY	OFF	OFF	
SAM to NOM trs.	no effect	no effect	no effect	
>>	STBY	OFF	OFF	
Preparation	The instrument is configured as prime, and an observation sequence from MTL is started.	The instrument is turned ON and sets in STBY by GND TC	The instrument is turned ON and sets in STBY by GND TC	
>>	observation (MTL)	STBY	STBY	
NOM to EAM trs.	The observation conducted from MTL is interrupted by the emergency OBCP, and HIFI is set in STBY.	The OBCP to turn the instrument in STBY is run, which shall only re-enforce the instrument state.	The OBCP to turn the instrument in STBY is run, which shall only re-enforce the instrument state.	
>>	STBY	STBY	STBY	
EAM to SM trs.	The emergency OBCP turns OFF the instrument	The emergency OBCP turns OFF the instrument	The emergency OBCP turns OFF the instrument	
>>	OFF	OFF	OFF	
5.8.5.17. EAM to SAM (needs new SM to SAM, SAM to NOM and NOM to EAM)	Preparation	-	-	The instrument is turned ON and sets in STBY by GND TC
	>>	OFF	OFF	STBY
	SM to SAM trs.	no effect	no effect	no effect
	>>	OFF	OFF	STBY
	SAM to NOM trs.	no effect	no effect	no effect
	>>	OFF	OFF	STBY
Preparation	The instrument is turned ON and set in STBY by GND TC	The instrument is turned ON and set in STBY by GND TC	The instrument is configured as PRIME in photometer mode, and an observation sequence from MTL is started.	SPIRE is tested only in photometer because the cryostat is not necessarily horizontal for this sequence. If the cryostat is horizontal, the spectrometer mode may be used instead of the photometer one in order to cover more configuration cases.
>>	STBY	STBY	Photometer (MTL)	



	Test step description	action or observed event description			Additional comments
		>> instrument state (as per "satellite state" table when available in SP-0939)			
		HIFI	PACS	SPIRE	
	NOM to EAM trs.	OBCP to turn the instrument to STBY is re-enforced	OBCP to turn the instrument to STBY is re-enforced	Observation conducted from MTL is interrupted by emergency OBCP, and SPIRE is set in STBY.	
	>>	STBY	STBY	STBY	
	EAM to SAM trs.	emergency OBCP turn OFF the instrument	emergency OBCP turn OFF the instrument	emergency OBCP turn OFF the instrument	
	>>	OFF	OFF	OFF	
5.8.5.18.	Preparation	-	The instrument is turned ON and sets in STBY by GND TC	-	
	>>	OFF	STBY	OFF	
	SAM to NOM trs.	no effect	no effect	no effect	
	>>	OFF	STBY	OFF	
	Preparation	The instrument is turned ON and sets in STBY by GND TC	The instrument is configured as PRIME in burst mode, and an observation sequence from MTL is started.	The instrument is turned ON and sets in STBY by GND TC	
	>>	STBY	Observation (MTL/burst)	STBY	
	NOM to SAM trs.	emergency OBCP turn OFF the instrument	The observation conducted from MTL is interrupted by the emergency OBCP, and PACS is set OFF.	emergency OBCP turn OFF the instrument	
>>	OFF	OFF	OFF		
5.8.6.	S/C reconfiguration				
5.8.6.2.	Test start configuration	Preparation	The instrument is turned ON and sets in STBY by GND TC	The instrument is turned ON and sets in STBY by GND TC	The instrument is turned ON and sets in STBY by GND TC
		>>	STBY	STBY	STBY

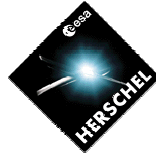

		Test step description	action or observed event description			Additional comments
			>> instrument state (as per "satellite state" table when available in SP-0939)			
			HIFI	PACS	SPIRE	
5.8.6.3.	NOM Mode to EAM transition (CDMS level 3a)	Preparation	The instrument is configured as prime, and an observation sequence from MTL is started.	-	-	
		>>	observation (MTL)	STBY	STBY	
		CDMS level 3a alarm	The observation conducted from MTL is interrupted by emergency OBCP, and HIFI is set in STBY.	The OBCP to turn the instrument in STBY is run, which shall only re-enforce the instrument state.	The OBCP to turn the instrument in STBY is run, which shall only re-enforce the instrument state.	
		>>	STBY	STBY	STBY	
5.8.6.4.	EAM to SAM (CDMS level 3b)	2nd CDMS level 3a alarm	The OBCP to turn the instrument in STBY is run, which shall only re-enforce the instrument state.	The OBCP to turn the instrument in STBY is run, which shall only re-enforce the instrument state.	The OBCP to turn the instrument in STBY is run, which shall only re-enforce the instrument state.	
		>>	STBY	STBY	STBY	
		CDMS level 3b alarm	The OBCP to turn the instrument in STBY is run, which shall only re-enforce the instrument state.	The OBCP to turn the instrument in STBY is run, which shall only re-enforce the instrument state.	The OBCP to turn the instrument in STBY is run, which shall only re-enforce the instrument state.	
		>>	STBY	STBY	STBY	
5.8.6.5.	NOM mode to SAM (ACMS level 4 (ACMS in Survival Mode))	Preparation	-	-	The instrument is configured as PRIME in photometer mode, and an observation sequence from MTL is started.	
		>>	STBY	STBY	Photometer (MTL)	
		ACMS level 4 alarm	The emergency OBCP turns OFF the instrument	The emergency OBCP turns OFF the instrument	The emergency OBCP turns OFF the instrument	
		>>	OFF	OFF	OFF	

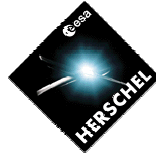

		Test step description	action or observed event description			Additional comments
			>> instrument state (as per "satellite state" table when available in SP-0939)			
			HIFI	PACS	SPIRE	
5.8.6.7.	NOM Mode to Survival Mode (CDMS level 4)	Preparation	The instrument is turned ON and sets in STBY by GND TC	The instrument is turned ON and sets in STBY by GND TC	The instrument is turned ON and sets in STBY by GND TC, then the instrument is configured as PRIME in photometer mode, and an observation sequence from MTL is started.	SPIRE Switched OFF via DNEL !
		>>	STBY	STBY	Photometer (MTL)	
		CDMS level 4 alarm	all the instrument supply LCL are turned OFF by HW DNEL	all the instrument supply LCL are turned OFF by HW DNEL	all the instrument supply LCL are turned OFF by HW DNEL	
		>>	OFF	OFF	OFF	
5.8.7.	CDMS management					
	Test start configuration	Preparation	The instrument is turned ON and sets in STBY by GND TC	The instrument is turned ON and sets in STBY by GND TC, then in photometer/burst mode to fill SSMM.	The instrument is turned ON and sets in STBY by GND TC	
				PACS is returned in STBY.	The instrument is configured as PRIME in photometer mode, and an observation sequence from MTL is started.	
		>>	STBY	STBY	Photometer (MTL)	

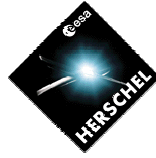

	Test step description	action or observed event description			Additional comments
		>> instrument state (as per "satellite state" table when available in SP-0939)			
		HIFI	PACS	SPIRE	
EAT / FDIR test	EAT test	-	-	The test mode is entered by GND TC while the MTL is active but send no TC, and the generation of a SPIRE-TM(5,2,0xC100) event is commanded. Two minutes later a SPIRE-TM(5,2,0xC110) is generated. Then the instrument is set back in photometer mode.	<p>This test verify the the correct CDMS MOT operation (i.e. OBCP is run as an answer to an instrument generated event).</p> <p>The ideal situation would be to trig the events 5,2,0xC100 and 5,2,0xC110 without living the photometer mode. But this is identified as not possible.</p>
	>>	STBY	STBY	Photometer (MTL)	
	EAT and SPIRE OBCP associated to TM(5,2,0xC100/OxC110) verification	-	-	Next MTL sub-schedule configure back SPIRE for a new operation in photometer mode	
	>>	STBY	STBY	Photometer (MTL)	
DTCP simulation	Nominal DTCP hand over	-	-	The observation is ended by MTL and SPIRE is returned to STBY	Intensive MTL, OBCP management exercise is led in parallel
	>>	STBY	STBY	STBY	
	Nominal DTCP hand over	The instrument is configured as PRIME by the MTL, and an observation sequence from MTL is started.	-	-	
	>>	observation (MTL)	STBY	STBY	
	OBT is adjusted 3.14s forward in time	the instrument shall copy the new OBT	the instrument shall copy the new OBT	the instrument shall copy the new OBT	OBT operation / problem test
>>	observation (MTL)	STBY	STBY		

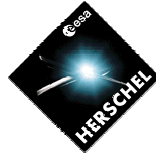

	Test step description	action or observed event description			Additional comments
		>> instrument state (as per "satellite state" table when available in SP-0939)			
		HIFI	PACS	SPIRE	
	OBT is adjusted 3.14s backward in time	the instrument shall copy the new OBT	the instrument shall copy the new OBT	the instrument shall copy the new OBT	
	>>	observation (MTL)	STBY	STBY	
Verification of correct behaviour of MTL after delete/add/modify operation	MTL execution verification	-	-	-	MTL has been manipulated in background of previous operation.
	>>	observation (MTL)	STBY	STBY	
Test end if test not concatenated with sequence 5.8.8	if test not concatenated with sequence 5.8.8	The instrument is returned is STBY, then turned OFF by GND TC	The instrument is turned OFF by GNT TC	The instrument is turned OFF by GNT TC	
	>>	OFF	OFF	OFF	
5.8.8. DTCP worst case scenario					
Test start configuration	Preparation	The instrument is turned ON and sets in STBY by GND TC	The instrument is turned ON and sets in STBY by GND TC, then in photometer/burst observation sequence from MTL to fill SSMM and load the CMDS	The instrument is turned ON and sets in STBY by GND TC	
	>>	STBY	observation (MTL/burst)	STBY	
1553 Bust loading phase	start of instrument new ASW image load test	The instrument is turn OFF (clean procedure) then turned ON and running on BOOT SW. A dummy 1Mo SW image up-load (in DM RAM) is started.	-	-	
	>>	loading ASW in DM	observation (MTL/burst)	STBY	
TM/TC Link load phase	hand-over	A dummy ASW image is loaded	The observation is ended under MTL control and the instrument is sets in STBY	-	SPIRE operation shall use OBCP as much as possible

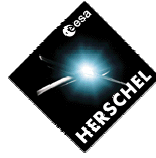

Test step description	action or observed event description			Additional comments
	>> instrument state (as per "satellite state" table when available in SP-0939)			
	HIFI	PACS	SPIRE	
>>	loading ASW in DM	STBY	STBY	
hand-over	ASW loading	-	The instrument is configured as PRIME in photometer mode, and an observation sequence from MTL is started with real time science downlink	
>>	loading ASW in DM	STBY	Photometer (MTL/rl tm sc)	
hand-over	When the ASW up-load is ended, its transfer in PM RAM is commanded with the load and wait command (no boot). Then the instrument is commanded to boot on EEPROM ASW image.	-	-	The up-loaded dummy image shall be set-up (page header data) so that the pages install themselves PM RAM zones not used by the flight ASW. SO at the end of operation, the normal ASW shall be running, with dummy data present in separate PM RAM area.
>>	STBY	STBY	Photometer (MTL/rl tm sc)	
1553 bus release	-	-	The observation is ended under GND control and the instrument is sets in STBY (end of real time science windows)	
>>	STBY	STBY	STBY	
Instrument ASW upgrade test verification phase	1553 loaded ASW verification	The PM RAM area containing the uploaded dummy ASW image is dumped.	-	
>>	STBY	STBY	STBY	

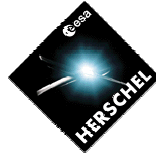

	Test step description	action or observed event description			Additional comments	
		>> instrument state (as per "satellite state" table when available in SP-0939)				
		HIFI	PACS	SPIRE		
	instrument EEPROM patch capability verification	2 words are written in the instrument EEPROM in an EEPROM page reserved for this test. The words values are chosen to toggle the memory cell values from previous one (i.e. previous test). Then the full EEPROM contain is dumped. The operation repeated for the 3 instruments (one by one).			The reserved area shall be such that even only 2 words are written, the overall affected EEPROM page is use for nothing else, to not impact the re-writing count of any useful memory cell.	
	>>	STBY	STBY	STBY		
Simulacrum of new HIFI ASW image test	hand-over	The instrument is configured as PRIME, and an observation sequence from MTL is started with real time science download enabled by GND TC	-	-		
	>>	observation (MTL/rl tm sc)	STBY	STBY		
Verification of correct behaviour of system after intensive operations	end of DTCP	The real time sc. in disabled from GND TC	-	-		
	>>	observation (MTL)	STBY	STBY		
	execution verification	-	-	-		
Test end if test not concatenated with sequence 5.8.8	>>	observation (MTL)	STBY	STBY		
	if test not concatenated with sequence 5.9.3	The instrument is returned is STBY then turned OFF by GND TC	The instrument is turned OFF by GND TC	The instrument is turned OFF by GND TC		
	>>	OFF	OFF	OFF		
5.8.9.	REFERENCE Mission Scenario (in discussion with ESOC)					
5.8.9.2.	Test start configuration	Preparation	The instrument is turned ON and sets in STBY by GND TC	The instrument is turned ON and sets in STBY by GND TC, then in photometer/burst observation sequence from MTL to fill SSMM and load the CMDS	The instrument is turned ON and sets in STBY by GND TC	Note with respect to the instrument OD. The baseline on ACMS side, is that the observation require target and observations which correspond to the sequence given in appendix 5 of SP-0939, as recalled below.

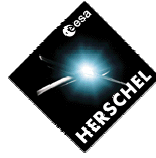

	Test step description	action or observed event description			Additional comments
		>> instrument state (as per "satellite state" table when available in SP-0939)			
		HIFI	PACS	SPIRE	
	>>	STBY	observation (MTL)	STBY	
DTCP1	hand-over	The instrument is configured as PRIME, and an observation sequence is started, all under MTL TC	The observation is ended under MTL control and the instrument is set in STBY	-	
	>>	observation (MTL)	STBY	STBY	
5.8.9.4. HIFI OD		according HIFI specification. The operation shall include an observation with peak-up.	-	-	It would be find that one first observation "needs" a Solar System Object tracking, then a second one "needs" a line scanning with OFF position, then a third one "needs" 4 nodding arranged as 2x2 rasters, then a fourth one "needs" a fixed pointing (near the operation domain limit)
	>>	observation (MTL)	STBY	STBY	
DTCP2 (no contact with ground)	hand-over	The observation is ended under MTL control and the instrument is set in STBY	The instrument is configured as prime, and an observation sequence is started, all under MTL TC	-	
	>>	STBY	observation (MTL)	STBY	
5.8.9.5. PACS OD		-	according PACS specification	-	It would be find that one first observation "needs" a Solar System Object tracking, then a second one "needs" a line scanning with OFF position, then a third one "needs" 4 nodding arranged as 2x2 rasters, then a fourth one "needs" a fixed pointing (near the operation domain limit)
	>>	STBY	observation (MTL)	STBY	

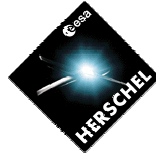

		Test step description	action or observed event description			Additional comments
			>> instrument state (as per "satellite state" table when available in SP-0939)			
			HIFI	PACS	SPIRE	
	DTCP3	hand-over	-	The observation is ended under MTL control and the instrument is set in STBY	The instrument is configured as PRIME, and an observation sequence is started, all under MTL TC	
		>>	STBY	STBY	observation (MTL)	
5.8.9.6.	SPIRE OD		-	-	according SPIRE specification	It would be find that one first observation "needs" a Solar System Object tracking, then a second one "needs" a line scanning with OFF position, then a third one "needs" 4 nodding arranged as 2x2 rasters, then a fourth one "needs" a fixed pointing (near the operation domain limit)
		>>	STBY	STBY	observation (MTL)	
	DTCP4	hand-over	The instrument is configured as PRIME, and an observation sequence is started, all under MTL TC	-	The observation is ended under MTL control and the instrument is set in STBY	
		>>	observation (MTL)	STBY	STBY	
	Test trailer (verifications)		according HIFI specification	-	-	
		>>	observation (MTL)	STBY	STBY	
5.8.9.7.	Test end	end of test	The instrument is returned is STBY then turned OFF by GND TC	The instrument is turned OFF by GNT TC	The instrument is turned OFF by GNT TC	
		>>	OFF	OFF	OFF	
5.8.10.	Launch clean run					
		Activity	none	none	none	
		>>	OFF	OFF	OFF	
5.9.2.	Launch sequence robustness					
		Activity	none	none	none	

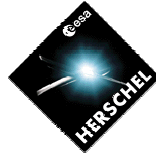

		Test step description	action or observed event description			Additional comments
			>> instrument state (as per "satellite state" table when available in SP-0939)			
			HIFI	PACS	SPIRE	
		>>	OFF	OFF	OFF	
5.9.3.	NOM mode robustness					
	Test start configuration	Preparation	The instrument is turned ON and sets in STBY by GND TC	The instrument is turned ON and sets in STBY by GND TC, then set-up as PRIME in photometer/burst for filling the SSMM during the sequence preparation, then set in usual photometer mode for an observation sequence from MTL.	The instrument is turned ON and sets in STBY by GND TC	
		>>	STBY	observation (MTL)	STBY	
	1553 bus BC failure test	1553 bus cut	The instrument continue observation but 1553 bus is cut (no signal). After several minutes (several successive alarms and reconfiguration attempts by CDMS), the connection is re-established			In the instrument, some TM buffers overrun, OBT discontinuity is likely to be observed, but this shall not jam the recovery.
		>>	STBY	observation (MTL)	STBY	
		recovery	The OBCP to turn the instrument in STBY is run, which shall only re-enforce the instrument state.	The emergency OBCP shall turn the instrument to STBY despite its likely unstable state	The OBCP to turn the instrument in STBY is run, which shall only re-enforce the instrument state.	
		>>	STBY	STBY	STBY	
	ACC RT failure test	Preparation	-	-	The instrument is set as PRIME in photometer mode for an observation sequence from MTL	The ACC RT failure case shall be transparent with respect to the instrument operation (standard interruption by OBCP).
		>>	STBY	STBY	observation (MTL)	

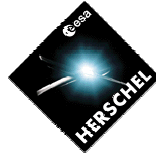

Test step description	action or observed event description			Additional comments
	>> instrument state (as per "satellite state" table when available in SP-0939)			
	HIFI	PACS	SPIRE	
ACMS RT access corruption and subsequent CDMS alarm 3a	The OBCP to turn the instrument in STBY is run, which shall only re-enforce the instrument state.	The OBCP to turn the instrument in STBY is run, which shall only re-enforce the instrument state.	The OBCP to turn the instrument in STBY is run, which shall return the instrument to a coherent state.	
>>	STBY	STBY	STBY	
ACC recovery	The instrument is turned OFF by GND TC	The instrument is turned OFF by GND TC	The instrument is turned OFF by GND TC	
>>	OFF	OFF	OFF	
end of recovery	-	-	-	
>>	OFF	OFF	OFF	
end of test	-	-	-	
>>	OFF	OFF	OFF	
Test end if test not concatenated with an another sequence				
	obs = observation			
	trs. = transition			
	rl tm sc = real time science			
	sc = science			

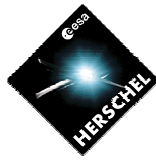

4.7 TV/TB test

The Herschel TV/TB test will take place in the LSS, with the objective to test the satellite and instruments near the extreme cold and warm temperature, and have the cryostat in near orbital condition, to correlate the thermal model.

It will be for instrument a nice opportunity to test the instrument in a near flight conditions. (only near flight, as the test will be in LN2 cooled shroud, with CVV at 100K compared to 70K, and mass flow 4mg/s compared to 2.2 in orbit. (see section 3.2.1 & RD 31 & 32).

The Herschel TV test is covered by AD-22 – Herschel TV test specification - H-P-2-ASP-TS-0997_1.0 (31/8/05). This document will be updated in due time.

The test sequence proposed is the following:

Day	1	2	3	4	5	6	7	8	9	10	11	12	13	14	15	16	17	18	19	20	21	22	23	24	25	26	27	28	29
PLM	PLM-TB1																			PLM-TB2				WUP					
instruments														HIFI	PACS	SPIRE	PARA												
SVM	SVM-TB1		SVM-TB2															SVM-TV1		SVM-TV2									

Two full days (48h) are allocated for dedicated instruments test.

The test sequence to be run during the TV test with instruments have been discussed during the IST preparation and are described in the following sections:

4.7.1 PACS TV Test

Applicable procedure for PACS TV test:

AD-101 – PACS-ME-TP-032_tbd - PACS TV test procedures - TBW

The test sequence to be run during PACS TV test is:

Activity	Duration	Time	Time from cooler recycling
PACS TB/TV Testing	40:47:00		
PACS Full Functional Test (FFT) at Hell conditions	10:29:00		
Switchon (OFF – SAFE Transition)	0:06:00	0:06:00	
Memory Management Test	0:06:00	0:12:00	
SetupSpectroscopyCSoff (+Llock open)	0:18:00	0:30:00	
Grating Test	0:12:00	0:42:00	
Thermal behaviour SPEC	1:30:00	2:12:00	
Ge:Ga heater	0:18:00	2:30:00	
Ge:Ga flasher	0:15:00	2:45:00	
SetupSpectroscopy, FW SPEC, data rates and background adjustment	2:00:00	4:45:00	
Chopper full FoV move	0:18:00	5:03:00	
Medium sampling grating scan (2 filters)	1:00:00	6:03:00	
Cooler recycling	2:12:00	8:15:00	2:12:00
Thermal behaviour PHOT	1:30:00	9:45:00	3:42:00



Activity		Duration	Time	Time from cooler recycling
	SetupPhotometry, FW PHOT, data rates	0:36:00	10:21:00	4:18:00
	Bolometers saturation check	0:06:00	10:27:00	4:24:00
	Enter Safe Mode	0:02:00	10:29:00	4:26:00
Short Performance Test at HeII, SPEC		8:17:00		
	Memory Management Test	0:00:00	10:29:00	4:32:00
	Setup Spectroscopy CS off (+Llock open)	0:00:00	10:29:00	4:50:00
	Ge:Ga dark currents on internal CSs (cold)	0:39:00	11:08:00	5:29:00
	Grating performance test (full diagnostic monitoring, exploration of stepping performances on full accessible range)	0:33:00	11:41:00	6:02:00
	Chopper performance test (duty cycle at different frequencies, OBCP sync.)	0:12:00	11:53:00	6:14:00
	Emissivity of internal CSs	0:45:00	12:38:00	6:59:00
	Quick Wavelength check	0:18:00	12:56:00	7:17:00
	Grating RSRF	3:06:00	16:02:00	10:23:00
	S/N as function of reset interval	0:15:00	16:17:00	10:38:00
	Different bias settings for Ge:Ga detectors	0:18:00	16:35:00	10:56:00
	Test of internal calibration recipes SPEC	0:00:00	16:35:00	10:56:00
	Time constants for flux changes spectroscopy	0:30:00	17:05:00	11:26:00
	Internal CSs performance test	1:06:00	18:11:00	12:32:00
	Detector selection table test SPEC	0:18:00	18:29:00	12:50:00
	SPU compression/reduction test	0:15:00	18:44:00	13:05:00
	Enter Safe Mode	0:02:00	18:46:00	13:07:00
Short Performance Test at HeII, PHOT		4:28:00		
	Cooler recycling	0:00:00	18:46:00	13:07:00
	SetupPhotometry	0:36:00	19:22:00	13:43:00
	Test of internal calibration recipes PHOT	0:36:00	19:58:00	14:19:00
	Focal plane map with CSs and representative background (updated see HP2ASEDSD0064)	0:42:00	20:40:00	15:01:00
	Staring measurement on CS for low frequency noise	1:30:00	22:10:00	16:31:00
	Time constants for flux changes photometry	0:30:00	22:40:00	17:01:00
	Detector selection table test PHOT	0:06:00	22:46:00	17:07:00
	SPU compression/reduction test PHOT	0:15:00	23:01:00	17:22:00
	Test pattern photometry	0:06:00	23:07:00	17:28:00
	Enter Safe Mode	0:02:00	23:09:00	17:30:00
	Configure PACS to nonPrime	0:05:00	23:14:00	17:35:00
AOT Tests (Astronomical Observation template):		6:00:00		
	Switchon (Nominal)	0:06:00	23:20:00	17:41:00
	SetupPhotometry	0:36:00	23:56:00	18:17:00
	"TuttiFrutti" AOT test PHOT	0:30:00	24:26:00	18:47:00
	PHOT AOT concepts (based on lessons learnt: EQM IMT, FM ILT)	1:00:00	25:26:00	19:47:00
	Enter SAFE mode	0:06:00	25:32:00	19:53:00
	SetupSpectroscopy	0:36:00	26:08:00	20:29:00
	"TuttiFrutti" AOT test SPEC	0:30:00	26:38:00	20:59:00
	SPEC AOT concepts (based on lessons learnt: EQM IMT, FM ILT)	2:00:00	28:38:00	22:59:00
	Ge:Ga detector curing procedure	0:30:00	29:08:00	20:59:00



Activity	Duration	Time	Time from cooler recycling
Enter SAFE mode	0:06:00	29:14:00	21:05:00
Switch off (redundant)	0:00:00	29:14:00	21:05:00
Test of redundant PACS instrument: (new for FM)	4:48:00		
Switch on (redundant)	0:06:00	29:20:00	17:36:00
Cooler recycling	2:12:00	31:32:00	2:12:00
Setup Photometry (other controller params !)	0:36:00	32:08:00	2:48:00
Two/Three position chopping w/wo CSs	0:30:00	32:38:00	3:18:00
Enter SAFE mode	0:06:00	32:44:00	3:24:00
Setup Spectroscopy (other controller params!)	0:36:00	33:20:00	4:00:00
Line scan AOT with variation of internal calibration concept	0:36:00	33:56:00	4:36:00
Enter SAFE mode	0:06:00	34:02:00	4:42:00
Switch off (redundant)	0:00:00	34:02:00	4:42:00

4.7.2 SPIRE TV Test

The SPIRE TV test procedure is :

AD-102 – SPIRE TV test procedures – TBW

The SPIRE TV test sequence is the following:

Activity	Duration	Time	Time from cooler recycle
SPIRE TB/TV Testing	48:00:00		
SPIRE Cooler recycle (automatic)	6:40:00		
Switch to REDY mode from SPEC STBY	0:10:00	0:10:00	
Automatic cooler recycle CREC	2:00:00	2:10:00	0:00:00
Wait for stable temperature conditions (steady-state case)	4:30:00	6:40:00	4:30:00
Thermal Worst Case Scenarios (PHOT/SPEC AOT observations)	41:20:00		
Switch to PHOT STBY	0:10:00	6:50:00	4:40:00
Transient Thermal Test in Photometer Mode			
Photometer POF4 AOT operation using highest photometer power dissipation (worst case scenario)	5:00:00	11:50:00	9:40:00
Photometer scan mode POF5 - Extra AOT Tests (Astronomical Observation template) TBD	5:00:00	16:50:00	14:40:00
Photometer scan mode POF5 - Test of Redundant SPIRE Instrument	5:00:00	21:50:00	19:40:00
Other Phot Modes (Extra AOT Tests)- TBD	3:00:00	24:50:00	22:40:00
Switch to SPEC STBY	0:10:00	25:00:00	22:50:00
Transient Thermal Test in Spectrometer Mode		25:00:00	22:50:00
Spectrometer SOF2 AOT operation using highest spectrometer power dissipation (worst case scenario)	10:00:00	35:00:00	32:50:00
Other Spec Modes (Extra AOT Tests)- TBD	10:00:00	45:00:00	42:50:00

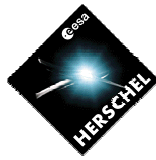

Activity	Duration	Time	Time from cooler recycle
Test of Redundant SPIRE Instrument (TBC)	3:00:00	48:00:00	45:50:00

4.7.3 HIFI TV test

HIFI TV test procedure is the following
AD-103 – HIFI TV test procedures - TBW

HIFI test sequence to be run during TV test is the following:
The fact that HIFI exceeds the 48h allocated has been agreed (similar test performed during commissioning has been reduced).

HIFI TB/TV Testing		Duration	Time
HIFI Performance test with FPU cold & warm units at operating T		74:42:00	
Functional tests HFI Subsystems		02:02:00	
	Switch-on HIFI (= OFF -> SAFE transition)	0:10:00	0:10:00
	ICU SFT & ICU FT	0:05:00	0:15:00
	FPU SFT & FP FT on Band 0	0:05:00	0:20:00
	HRS SFT & HRS FT	0:30:00	0:50:00
	WBS SFT & WBS FT	0:50:00	1:40:00
	FP SFT (all bands)	0:15:00	1:55:00
	LO SFT & LO FT	0:15:00	2:10:00
	Chopper scan fast (yes or not ?)	0:02:00	2:12:00
SFT & HIFI FT Sub-band Ia		1:55:00	4:07:00
	SFT Sub-band Ia		
	LO stabilisation @ f1 & stabilization measurement	0:55:00	0:55:00
	Spectrometer Attenuation Tuning	0:00:00	0:55:00
	LO Tune @ f1	0:05:00	1:00:00
	Magnet Tune @f1	0:00:00	1:00:00
	Diplexer Scan Slow	0:05:00	1:05:00
	Chopper Scan Slow	0:10:00	1:15:00
	FT Pumped	0:30:00	1:45:00
	LCU Stand-By @f1	0:00:00	1:45:00
	FT UnPumped	0:10:00	1:55:00
	LCU Config Safe @f1	0:00:00	1:55:00
	LCU switch off from safe		
Very Short Performance test band Ia		3:15:00	5:10:00
	Radiometry at 4 frequencys (f2-f5)	0:25:00	5:35:00
	Standing Wave @ f5	0:30:00	6:05:00
	Radiometry at 5 frequencys (f6-f10)	0:25:00	6:30:00

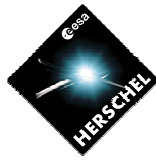

HIFI TB/TV Testing		Duration	Time
	Diplexer Scan Slow in Diplexer bands @ f10	0:05:00	6:35:00
	Chopper Scan Slow @ f10	0:10:00	6:45:00
	FT Pumped @ f10	0:30:00	7:15:00
	LCU Stand-By @f10	0:00:00	7:15:00
	FT unPumped @ f10	0:10:00	7:25:00
	LCU Conf Safe @f10	0:00:00	7:25:00
	LO Tune @ f10	0:00:00	7:25:00
	Magnet tuning @f10	0:00:00	7:25:00
	Stability test each sub-band @f10	1:00:00	8:25:00
	repeat SFT & VSPT at band Ib	5:10:00	13:35:00
	repeat SFT & VSPT at band IIa	5:10:00	18:45:00
	repeat SFT & VSPT at band IIb	5:10:00	23:55:00
	repeat SFT & VSPT at band IIIa	5:10:00	29:05:00
	repeat SFT & VSPT at band IIIb	5:10:00	34:15:00
	repeat SFT & VSPT at band IVa	5:10:00	39:25:00
	repeat SFT & VSPT at band Ivb	5:10:00	44:35:00
	repeat SFT & VSPT at band Va	5:10:00	49:45:00
	repeat SFT & VSPT at band Vb	5:10:00	54:55:00
	repeat SFT & VSPT at band VIlowa	5:10:00	60:05:00
	repeat SFT & VSPT at band VIlowb	5:10:00	65:15:00
	repeat SFT & VSPT at band VIhigha	5:10:00	70:25:00
	repeat SFT & VSPT at band VIhighb	5:10:00	75:35:00
	Standby / Shut Down	0:10:00	75:45:00

4.7.4 SPIRE/PACS parallel TV test

The PACS & SPIRE parallel mode test procedure should be included in the PACS & SPIRE TV test procedure AD 101 & 102.

The test sequence agreed is the following:

Activity	Duration	Time	Time from SPIRE cooler recycling	Time from PACS Cooler recycling
PACS/SPIRE Parallel Mode Test during IST	6:45:00			
PACS Switch ON	0:05:00	0:05:00		
SPIRE Switch ON	0:05:00	0:10:00		
HIFI switch on in standby non Prime Mode	0:05:00	0:15:00		
CCS Parallele mode 1553	0:00:00	0:15:00		
SPIRE Cooler recycle	2:00:00	2:15:00	1:30:00	2:00:00

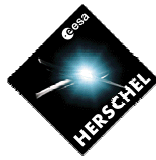

Activity	Duration	Time	Time from SPIRE cooler recycling	Time from PACS Cooler recycling
PACS Cooler recycle	0:45:00	3:00:00	2:15:00	2:45:00
SPIRE Set up Photometer (Get parameter from IEGSE)	0:10:00	3:10:00	2:25:00	2:55:00
SPIRE Set the nominal bias level for all photometer arrays	0:02:00	3:12:00	2:27:00	2:57:00
SPIRE Stop data generation	0:02:00	3:14:00	2:29:00	2:59:00
SPIRE Perform a PCAL Flash	0:02:00	3:16:00	2:31:00	3:01:00
SPIRE Switch to parallel mode Setup for full photometer data sampling at ~10Hz	0:02:00	3:18:00	2:33:00	3:03:00
SPIRE Mark the parallel mode science data with an OBSID	0:02:00	3:20:00	2:35:00	3:05:00
PACS Thermal Behaviour Test in Photometry	1:30:00	4:50:00	4:05:00	4:35:00
PACS Setup Photometry	0:36:00	5:26:00	4:41:00	5:11:00
PACS Single Band Photometry	0:30:00	5:56:00	5:11:00	5:41:00
PACS Dual Band Photometry	0:30:00	6:26:00	5:41:00	6:11:00
SPIRE Switch to CCS handler on I-EGSE	0:06:00	6:32:00	5:47:00	6:17:00
SPIRE End the parallel observation	0:02:00	6:34:00	5:49:00	6:19:00
SPIRE to photometer standby	0:02:00	6:36:00	5:51:00	6:21:00
SPIRE Perform a PCAL Flash	0:02:00	6:38:00	5:53:00	6:23:00
SPIRE Stop data generation	0:02:00	6:40:00	5:55:00	6:25:00
SPIRE to ready from photometer standby	0:02:00	6:42:00	5:57:00	6:27:00
PACS Switch Off	0:01:00	6:43:00	5:58:00	6:28:00
SPIRE Switch OFF	0:01:00	6:44:00	5:59:00	6:29:00
HIFI Switch OFF	0:01:00	6:45:00	6:00:00	6:30:00

4.8 EMC test

The overall Herschel FM EMC test specification is **AD-23 – Herschel EMC test specification - H-P-2-ASP-TS-0819 2.0 (TBW)**.

The EMC test will be split in 2 phases: _

EMC test 1, with mainly Conducted Emission (CE) on power lines test, will be performed after IST 1, with the satellite still in Astrium Immenstadt for test facility reasons, and access to power lines (SVM panel might need to be open to install current probes) _

EMC2 test, performed after TV test (in Estec), will consist in Radiated Emission (RE) test (mainly measurement of the emission of the SVM), followed by Radiated susceptibility (RS) test, where the previously measured levels + margin (8 to 20dB) will be re-injected around the satellite, with dedicated antennas..

For these 3 EMC tests, instruments will have to provide dedicated test sequence, where the instruments will have to be set up either in the most noisy mode (RE) or in the most sensitive mode (RS).

For all EMC test, only one of the nominal/Redundant part of the instrument will be used. Instruments teams to decide (from ILT results) which one is most suitable for this test (more noisy or more sensitive).



4.8.1 PACS EMC Test

The test procedure to be used for PACS EMC test is:

AD-91 – PACS-ME-TP-032_tbd - PACS EMC procedures - TBW

The test sequence to be run during PACS EMC test is:

Activity	Duration	Time	Time from cooler recycle
PACS EMC Testing during IST	17:01:30		
CE Test	5:36:30		
Switchon (OFF – SAFE Transition)	0:06:00	0:06:00	
SetupSpectroscopy	0:36:00	0:42:00	
Stays in spectroscopy mode as long as needed by EMC tests, execute most noisy mode test scripts as requested by EMC test flow	1:00:00	1:42:00	
Close the Grating Launch Lock	0:00:30	0:42:30	
Cooler recycling	2:12:00	3:54:00	2:12
SetupPhotometry	0:36:00	4:30:00	2:48
Stays in Photometry mode as long as needed by EMC tests, execute most noisy mode test scripts as requested by EMC test flow	1:00:00	5:30:00	3:48
Enter SAFE mode	0:06:00	5:36:00	3:54
Switch off	0:00:00	5:36:00	3:54
RE Test	5:36:30		
Switchon (OFF – SAFE Transition)	0:06:00	0:06:00	
Setup Spectroscopy	0:36:00	0:42:00	
Stays in spectroscopy mode as long as needed by EMC tests, execute most noisy mode test scripts as requested by EMC test flow	1:00:00	1:42:30	
Close the Grating Launch Lock	0:00:30	0:42:30	
Cooler recycling	2:12:00	3:54:30	2:12
SetupPhotometry	0:36:00	4:30:30	2:48
Stays in Photometry mode as long as needed by EMC tests, execute most noisy mode test scripts as requested by EMC test flow	1:00:00	5:30:30	3:48
Enter SAFE mode	0:06:00	5:36:30	3:54
Switch off	0:00:00	5:36:30	3:54
RS Test	5:48:30		
Switchon (OFF – SAFE Transition)	0:06:00	0:06:00	
SetupSpectroscopy + Most Sensitive Mode	0:42:00	0:48:00	
Stays in spectroscopy mode as long as needed by EMC tests	1:00:00	1:48:30	
Close the Grating Launch Lock	0:00:30	0:48:30	
Cooler recycling	2:12:00	4:00:30	2:12
SetupPhotometry	0:42:00	4:42:30	2:54
Stays in Photometry mode as long as needed by EMC tests	1:00:00	5:42:30	3:54
Enter SAFE mode	0:06:00	5:48:30	4:00
Switch off	0:00:00	5:48:30	4:00

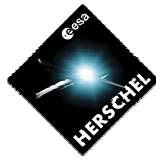

4.8.2 SPIRE EMC Test

The SPIRE EMC test procedure is **AD-92 – SPIRE EMC test procedures – TBW**

The SPIRE test sequence to be run during Herschel EMC test is the following: (Durations are TBD)

Activity	Duration	Time
SPIRE EMC 1	3:00:00	
CE Test	3:00:00	
Photometer most sensitive mode	1:00:00	1:00:00
Spectrometer most sensitive mode	1:00:00	2:00:00
SPIRE most emmissive mode	1:00:00	3:00:00
SPIRE EMC Testing 2	4:00:00	
RE Test	2:00:00	
RE E-Field	1:00:00	1:00:00
RE B-Field	1:00:00	2:00:00
RS Test	2:00:00	
RS E-Field	1:00:00	1:00:00
RS B-Field	1:00:00	2:00:00

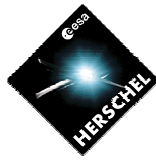

4.8.3 HIFI EMC test

The HIFI EMC test procedure is **AD-93 – HIFI EMC test procedures - TBW**

The HIFI test sequence to be run during Herschel EMC test is the following: (Durations are TBD)
The HIFI EMC test sequence is TBD.

5. SUCCESS CRITERIA

(Similar to AD21)

Considering that the present specification is a top level document which call after many sequences, the detailed success criteria are listed for each step of the sequence and sub sequence as part of the test definition, and shall be included in each test procedures.

For each instrument test step, the Instrument support team shall analyse the results (HK+Science) with the I-EGSE/QLA or dedicated science data analysis tool, and give the go ahead to proceed with the next step of the test.

5.1 "out of limit" and TC checking

5.1.1 BASIC Principle

The test success relies except for few test step specificity, on the automated checking realised by the CCS based on HPSDB settings, and specifically the TC checks associated with each TC command.

The baseline is that the TC checking is realised by the CCS in real time whenever possible.

The process is straightforward when simulating operation in "visibility". For the others: as:

- launch sequence,
- operation from MTL,

The real time control relies on the real time spying of S/C generated TM from the umbilical connection (for MTL operation the hypothesis is that the CSS will run a copy of the MTL in parallel to S/C to keep its model of the status up to date).

Nevertheless, each test success shall be determined from TM acquired in a flight representative way. This means that most tests shall end by a simulation of a TM downlink session (DTCP) or specific phase to recover the available stored telemetry in SSMM.

When this telemetry has been already analysed from the umbilical line for test success (that is usually in a non flight representative way), the test success shall be verified by at least comparing the SSMM stored telemetry with the real time acquired one, for being identical. This comparison may be done bit level, packet per packet, which is expected quicker than a "replay" of the test (the comparison method is TBC-37).

For a remaining set of test sequences and test steps, a real time control will not be possible:

- the clean run (by test principle),
- a few case of saturation or filtering of the real-time TM sent onto the umbilical.

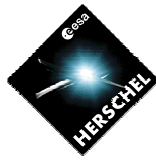

For those later cases, the test success will rely on a test session "replay" on the CCS from the retrieved SSMM data (note: test timeline at §5.1.2 does not include the time necessary fore those full or partial replays).

5.1.2 "soft" and "hard" limits

CCS monitoring considers 5 classes of monitoring limits: "soft OOL", "hard OOL", "delta OOL" and "consistency" and "event".

- a "event" limit triggering shall be associated with an automated emergency stop procedure run by the CCS.
- a "HARD OOL" and "consistency" limit triggering shall be associated with a test sequence abort (operator led procedure).
- a "SOFT" or "DELTA OOL" limits triggering, shall call upon the responsibility of the supporting engineering team for deciding in real time either the test abort or its continuation. A SOFT limit is a test failure indicator in any case, but not critical with respect to immediate safety of units under test. Real time decision shall considers if there is a danger for the S/C health (abort), and if not (shall be the case with a soft limit), the decision shall consider with respect to the test objective:
 - if there is no more way to consider the test successful, then test is worth to abort to save time or,
 - if the alarm open (likely) only minor anomaly on test results, then test is worth to continue (NB. from available real time data, as only post analysis will determine if sequence is acceptable or shall be re-run).

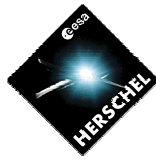

6. ORGANISATION & RESPONSABILITIES

6.1 Organisation

The test organisation and review will follow the rules defined in the PA plan (AD-6) and PA
The overall organisation during the test is as follows:

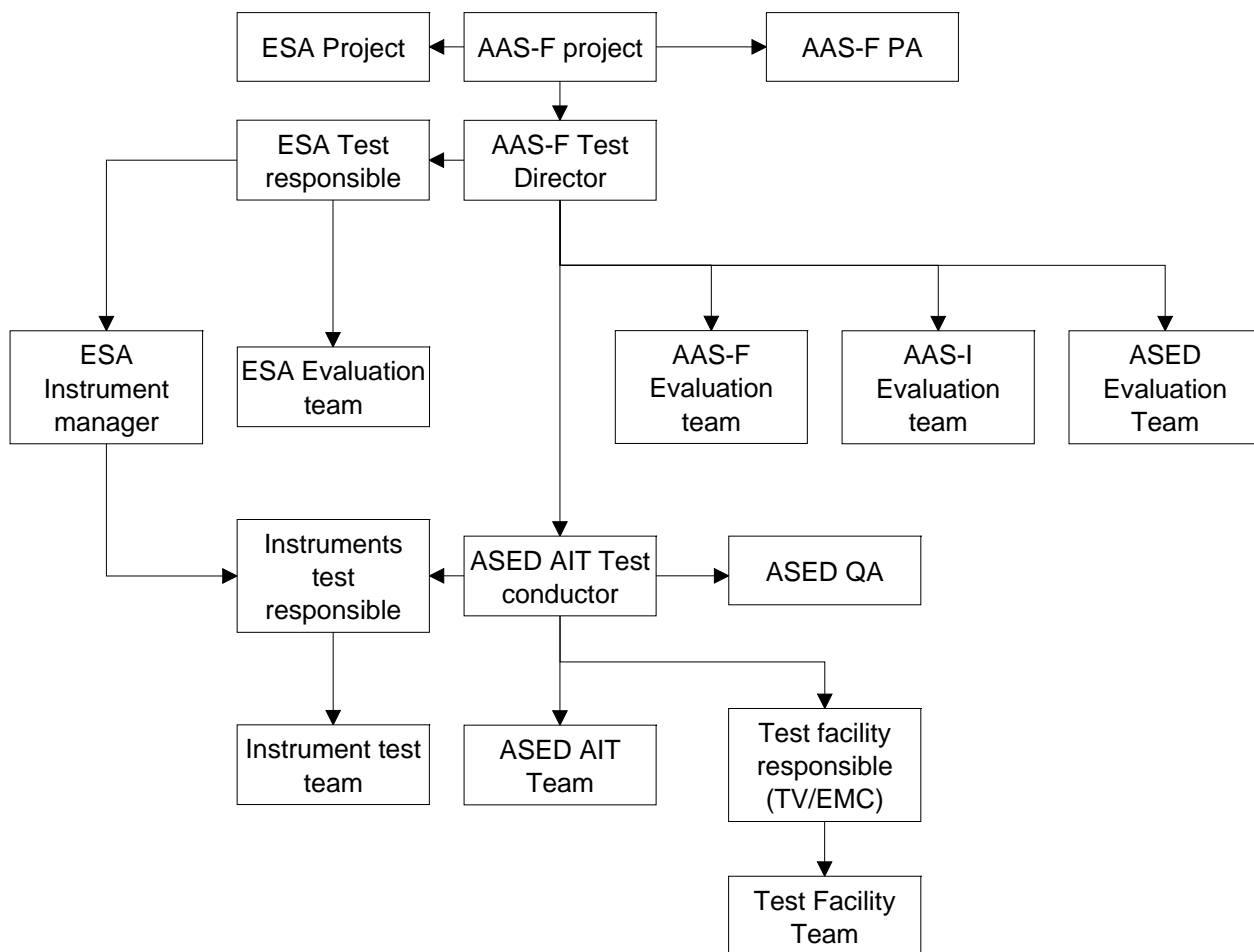

6.2 Test organisation

During the FM satellite / instrument test, the organisation of the working day will change with the test phase:

Integration & UFT: Normal working days (8h/day, 5j/7)
 IST commissioning, SPT, EMC: Long working days (10h/day, 6j/7)
 TV test + IST RMS: 3 shift operation: 24h/day, 7j/7)

The sequence for instrument tests, unless otherwise specified will be
 PACS → SPIRE → HIFI → (PACS/SPIRE parallel).

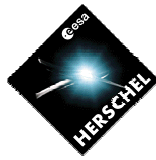

6.3 Responsibilities

The overall responsibility during the test is as follows:

The responsibilities linked to the test progress shall be mentioned in the AAS-F test leading procedure.

Organization	Name	Responsibility
AAS-F Project Representative	xxx	Alcatel project interface Represents AAS-F during the test and he is also the I/F point with the ESA representative
ESA Project Representative	xxx	ESA project interface Represents ESA during the test and he is also the I/F point with the AAS-F representative
AAS-F PA	xxx	AAS-F Project Assurance Manager
AAS-F Test Director	xxx	Issue the test specification of the relevant test to be performed Go ahead for the test reviews (TRR, key point, PTR) Single point of contact with the AAS-F Evaluation team concerning the test result status.
ESA Test Responsible	xxx	ESA point of contact I/F with ESA project I/F with AAS-F test director & ESA Payload Engineering Coordination
ESA Instruments I/F	xxx	I/F with AAS-F test director & Instruments evaluation teams
ASED AIT Conductor	xxx	Responsible of the ASED AIT Team Issue the leading procedure of all activities Manage all activities done during the test including "key point" meeting. I/F point with the Test Facility Team Responsible I/F point with the Instrument AIT Team Responsible Organize the Daily meeting Initialize NCR...
ASED AIT Team	xxx	Realize all S/C AIT activities within the arrival and the leaving Issue of the relevant test procedures Operate the GSE (except I-EGSE) Provide the test data Issue the test report.
Instruments AAS-F I/F	xxx	Issue section of the test specification relevant to the instrument. AAS-F instrument expert
AAS-F QA	xxx	Organize the review (TRR/PTR...) Minute the running meeting (Key point)
Instrument AIT Team Responsible	xxx	Is in charge of I/F point with the ASED test conductor Provide relevant test data in order to help the test director concerning the "Key point" status.
Instrument AIT Team	xxx	I-EGSE full use Issue the relevant test procedures Process the instrument test data and Test data analysis Issue the test report.

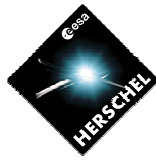

Organization	Name	Responsibility
Evaluation teams		Evaluate the test results (depending of test: electrical integration, IST, TV, EMC, ...)

6.4 Tasks distribution

	Herschel satellite					
	Test Specification	Test Procedure	Test Execution	test report (filled procedure)	Instrument test report	Test Evaluation report
WU + WIH + test harness (mechanical integration)	AAS-I (from ICD+ connector list)	AAS-I	AAS-I	AAS-I	-	-
Electrical Intégration test (WU having I/F with SVM)	AAS-I (AVM) AAS-F (FM)	AAS-I	AAS-I	AAS-I	-	-
UFT (tests elect WU)	AAS-F (leading)	ASED + Instrument	ASED	ASED	Instrument	AAS-F
SFT/ IST (tests fonc WU)	AAS-F	ASED + Instrument	ASED	ASED	Instrument	AAS-F
TV test	AAS-F	ASED + Instrument	ASED	ASED	Instrument	AAS-F
EMC tests	AAS-F	ASED + Instrument	ASED	ASED	Instrument	AAS-F

6.4.1 General Tasks breakdown

AAS-F is in charge of Herschel FM AIV

- the satellite activities and test management:
- Responsible of the test management and for interfaces between the satellite, instruments and facility.

ASED is in charge of Herschel FM AIT

- Preparation (tests definition, except for instruments) and execution
- S/C Cleaning, handling, mechanical mounting, electrical checkout, instruments modes set-up.
- Test management (reviews, leading procedure, daily meeting, key points , ...)
- Dedicated GSE installation/validations and use
- S/C data analysis.
- Running the test (Satellite & Instruments Operator)

AAS-I is in charge of SVM FM & Herschel AVM AIT

Instruments teams are in charge of:

- Preparation, tests definition for the instruments
- Dedicated GSE installation/validations and use (I.EGSE)
- Responsible for interfaces between the instrument GSE and test facility.
- Execution and interpretation of instrument performance data
- Provide relevant test data in order to help the test director concerning the "Key point" status.



- Instrument test report

7. DOCUMENTATION

7.1 Documents required before the test

S/C configuration (CIDL, etc)
Test set-up configuration (CIDL, Definition drawings)
Test Set-up validation and calibration status
Test specification
Test predictions
Instrumentation plan
Test leading procedure + elementary procedures

7.2 Data acquired during the test

7.2.1 S/C housekeeping

A listing (paper format) will provide the following information (output frequency TBD) about each type of specimen sensors (thermal, μ -vibration):

- Test phase designation
- Acquisition date/time
- Temperature sensor number
- Sensor designation
- Measured value (time & frequency domain for μ -vib)
- Alarms status

An excel file grouping information <Time, Temperature> of all specimen thermal sensors will be updated at a given frequency (TBD) and delivered on request to AAS-F thermal team.

An excel file grouping information <Time, Time domain> of all μ -vib sensors will be updated at a given frequency (TBD) and delivered on request to AAS-F evaluation team.

An excel file grouping <Time, Power / Amperage> of all specimen heating lines (including RAA Dummy) will be updated at a given frequency (TBD) and delivered on request to AAS-F evaluation team.

7.2.2 Instrument housekeeping

A listing (paper format) will provide the following information (output frequency TBD) about each type of specimen sensors (thermal, μ -vibration):

- Test phase designation
- Acquisition date/time
- Temperature sensor number
- Sensor designation
- Measured value
- Alarms status

An excel file grouping information <Time, Temperature> of all specimen thermal sensors will be updated at a given frequency (TBD) and delivered on request AAS-F/ESA evaluation team.



7.3 Documents issued after the test

7.3.1 Test Reports

7.3.1.1 Specimen AIT reports (ASED(FM), AAS-I (AVM))

As a minimum, the specimen AIT reports shall include:

- Filled test procedure
- Test progress description
- Contamination control report
- Logbook reporting all significant events about specimen
- Pictures taken on the specimen in test configuration
- Record (CD-ROM) of all acquired data during test
- Test measurements devices calibration reports

7.3.1.2 Test environment (EMC, TV)

As a minimum, the specimen AIT reports shall include:

- Test progress description
- Pictures taken on the test set-up
- Logbook reporting all significant events about test set-up
- Record (CD-ROM) of all acquired data during test
- Test measurements devices calibration reports

7.3.2 Evaluation reports

7.3.2.1 Evaluation report for satellite test

The deliverable are :

- Logbook reporting all significant events about each sequence success criteria, SFT, IST, TV/TB, EMC report including :
 - measured values for success criteria associated with analogue values (ex. DoD, pointing errors, at key steps etc.),
 - test results processing for all phases (plots and specific data processing possibly required step per step).

7.3.2.2 Evaluation report for instrument test

As a minimum, the instrument evaluation reports (provided by the instrument support team) shall include:

- Logbook reporting all significant events about each sequence success criteria, and specifically the ones only available from monitoring at IEGSE level,
- a short S/C test report including:
 - measured values for success criteria associated with analogue values (ex. DoD, pointing errors, at key steps etc.),



test results processing for all phases (plots and specific data processing possibly required step per step), specifically for the ones only available from processing at IEGSE level.

8. ANNEXES

END OF DOCUMENT