

Instrumentation Plan

Herschel

Title: **Instrumentation Plan for Mechanical Testing of H-EPLM STMFM**

CI-No: 120000

Prepared by:	M. v. Alberti <i>M. v. Alberti</i>	Date:	2.3.2007
Checked by:	J. Kroeker <i>J. Kroeker</i>		9.3.2007
Product Assurance:	R. Stritter <i>R. Stritter</i>		09.03.07
Configuration Control:	W. Wietbrock <i>W. Wietbrock</i>		15.03.07
Project Management:	Dr. W. Fricke <i>W. Fricke</i>		15/03/07

Distribution: See Distribution List (last page)

Copying of this document, and giving it to others and the use or communication of the contents thereof, are forbidden without express authority. Offenders are liable to the payment of damages. All rights are reserved in the event of the grant of a patent or the registration of a utility model or design.

Issue	Date	Sheet	Description of Change	Release
1	18.04.05		1st complete issue	
2	30.11.05		<p>2nd issue:</p> <p>For better readability, changes are not tracked.</p> <p>Accelerometers added on HSS Struts 02, 04, 05, 07, 09, 11 (local lateral in strut middle)</p> <p>Strain gauge definition on HSS Short Struts updated (now provided by Dutch Space, linear axial, 1/4 bridge)</p> <p>HSS instrumentation partially updated acc. to DS recommendations; see HP-2-DSSA-PL-0016. Several tri-ax sensors moved into panel orientation. Corresponding DS designations included in the table.</p> <p>Three TMD accelerometers moved (as per unit qualification test HP-2-PROT-RP-0034: Y7 instead of Y5, Y6 instead of Y2, Z3 instead of Z2)</p> <p>Waveguide accelerometers PAWAVG001Y and PAWAVG001Z split on two waveguides</p> <p>LOR accelerometer position defined to match CoG position</p> <p>SVM Thermal Shield accelerometer positions modified to match unit acoustic test</p> <p>MP setup for acoustic and sine harmonized (thereby adding several CC + CB accelerometers to the sine MP definition)</p> <p>TMS strain gauges updated: Only one s/g per strut is bonded. This reduction is driven by the s/g channel limit and justified because of the high bending frequency of the CFRP struts</p> <p>Wiring schematic for strain-gauges added</p> <p>Gauge factor table added in annex B</p> <p>Chapter on test harness routing added</p>	

Issue	Date	Sheet	Description of Change	Release
3	28.02.07	all	<p>Update for FM test campaign:</p> <p>Update in figures and tables not tracked by sidebar.</p> <p>A new section 3.7 was added discussing post-test access. Also, a new section 4.1 was added giving justifications for elimination of sensors. The table containing the instrumentation list in section 4.2 was updated. Deleted sensors are marked as "omitted" in the table.</p> <p>Following figures were changed:</p> <ul style="list-style-type: none"> • LOU Support Structure updated • LOU Baffle accelerometers added • TMS updated • TEL Dummy removed • CVV UB STR sensor removed • CB and CC figures updated • CVV external updated 	

Table of Contents

1	Scope	7
2	References	8
2.1	Applicable Documents	8
2.2	Reference Documents	8
3	Comments and explanations	9
3.1	Measurement points designation	9
3.2	Sensor types	9
3.3	Early instrumentation and accessibility constraints	10
3.4	Electrical connection of strain gauges	11
3.5	Calibration Factors for strain gauges	12
3.6	Test harness routing	12
3.7	Post FM acceptance test activities	12
4	Instrumentation List	14
4.1	Justification for deletion of STM sensors	14
4.2	H-EPLM FM instrumentation list	16
5	Annex A: Position of Measurement Points	28
5.1	Internal Cryostat Accelerometers	28
5.2	HSS instrumentation	34
5.3	External EPLM instrumentation	38
6	Annex B: Strain-gauge definitions	47

Table of Figures

Figure 3-1: Quarter bridge schematic 11

Figure 3-2: Full bridge schematic..... 12

Figure 5-1: HTT accelerometers 28

Figure 5-2: HTT accelerometers (cont) 29

Figure 5-3: OBA Optical Bench Plate shown from below 30

Figure 5-4: PACS FPU sensor position 31

Figure 5-5: TS1 Upper Bulkhead 32

Figure 5-6: HOT accelerometers..... 33

Figure 5-7: Solar Array Panels..... 34

Figure 5-8: Sunshade Panels..... 35

Figure 5-9: Solar Array Struts..... 36

Figure 5-10: Sunshade Struts 37

Figure 5-11: CVV external accelerometers 38

Figure 5-12: Cryostat Cover..... 39

Figure 5-13: Cryostat Baffle..... 39

Figure 5-14: LOU Radiator 40

Figure 5-15: LOU Support Structure (shown with External LOU Baffle) 41

Figure 5-16: LOU Baffle I/F (baffle not shown) 41

Figure 5-17: LOU sensors (shown here on MTD) 42

Figure 5-18: LOU Waveguides 43

Figure 5-19: SVM/PLM Struts..... 44

Figure 5-20: SVM Thermal Shield 45

Figure 5-21: Telescope Mounting Structure, TMS..... 46

List of Tables

Table 3-1: MP designation scheme	9
Table 3-2: Sensors omitted since issue 1:.....	10

1 Scope

This document defines the H-EPLM instrumentation for mechanical **acceptance** tests

- Sine vibration test ~~on Hydra~~
- Acoustic noise test
- ~~Shock tests~~
- Microvibration test

to be performed on the Herschel **STMFM**.

2 References

2.1 Applicable Documents

AD #	Document Title	Document Identifier	Issue
AD 01	Herschel STM-FM Mechanical Test Specification	H-P-2-ASP-TS-0921	2 tbi
AD 02	Herschel FM Microvibration Test Specification	H-P-2-ASP-SP-1280	1
AD 0203	Herschel Satellite STM-FM Technical Description	H-P-1-ASP-TN-0664	2 tbi

2.2 Reference Documents

RD #	Document Title	Document Identifier	Issue
RD 01	Leading Procedure for Herschel S/C STM-FM Mechanical Tests	HP-2-ASED-TP-0059	2 tbi
RD 02	Sine Vibration Test Procedure for Herschel STMFM	HP-2-ASED-TP-0060	2 tbi
RD 03	Acoustic Noise Test Procedure for Herschel STMFM	HP-2-ASED-TP-0061	1 tbi
RD-04	Shock Test Procedure for Herschel-STM	HP-2-ASED-TP-0062	t tbi
RD 05	Microvibration Test Procedure for Herschel STMFM	HP-2-ASED-TP-0063	tbi

3 Comments and explanations

3.1 Measurement points designation

A unique string of 10 characters is assigned to the measurement points according to the following scheme:

Table 3-1: MP designation scheme

Digits	Fields	Content
1	Module designation	H - S/C S - SVM P - EPLM
1	Type of measurement	A - accelerometer S - strain gauge
4	Unit designation	e.g. "CVV-", "SA-S"
3	Unique number	e.g. 003
1	Measurement direction	X, Y, Z - global S/C O - local out-of-plane A - axial (e.g. strut direction) L - local lateral P - local perpendicular to "L"

Examples:

1234567890
PACSTR010X
PALOUR002X

This definition is compatible with the universal file format version 58 convention.

SVM measurement points follow their own designation logic.

3.2 Sensor types

The instrumentation described in this document will be used for the mechanical tests described in the individual test specifications [RD2] to [RD5].

Apart from the exceptions noted in the document, ETS will provide the instrumentation.

Internal accelerometers are of the type Endevco 2272. For external accelerometers the accelerometer type is mainly passive.

The strain gauge type is Vishay CEA, Constantan (K-factor=2.105 resp. 2.130 depending on temperature compensation type), 350Ω, linear resp. Tee Rosettes, 1/4" section length. Quarter-bridge gauges will be connected via 3-conductor leads to compensate cable length; full-bridges with 4-conductor leads. Epoxy glue will be used for bonding strain-gauges (M-Bond AE-10).

3.3 Early instrumentation and accessibility constraints

Internal cryostat accelerometers are not accessible. They are bolt-mounted to the cryostat structure. The harness is routed as part of the CCH. The interface to the data acquisition is at two positions of the CVV Cylinder (vacuum feed-throughs P02 on the lower ring and P38 on the upper ring). A dedicated test harness with Microdot 10-32 connectors to the ETS data acquisition will be provided by ASED.

The area between CVV and HSS (+Z side of H-EPLM) is difficult to access due to the HSS horizontal stiffener and the strut array. Due to poor accessibility the following sensors on the CVV were omitted **already for the STM test campaign:**

Table 3-2: Sensors omitted since issue 1:

MP ID	Type	Location
PACVVU004X	omitted	Upper CVV Ring, +Z position, STA 2222
PACVVU004Y	omitted	Upper CVV Ring, +Z position, STA 2222
PACVVL009X	omitted	Lower CVV Ring, +Z position, STA 544
PACVVL009Y	omitted	Lower CVV Ring, +Z position, STA 544

~~The following sensors are likely to remain installed after the STM test campaign and it is not possible to remove the cable prior to FM TB/TV acceptance. Thus, a specifically cleaned cable must be used and they shall be bonded with X60 glue instead of Loctite cyanacrylate.~~

Table 3-3: Sensors which may go into LSS test

MP ID	Type	Location	
PACVVU001X	Acc.	Upper CVV Ring, -Y position, STA 2222	X60 / clean cable
PACVVU001Z	Acc.	Upper CVV Ring, -Y position, STA 2222	X60 / clean cable
PACVVL006X	Acc.	Lower CVV Ring, -Y position, STA 544	X60 / clean cable
PACVVL006Z	Acc.	Lower CVV Ring, -Y position, STA 544	X60 / clean cable
PACSTR010X	Acc.	STR I/F pad on CVV Lower Bulkhead, -Z/+Y	X60 / clean cable
PACSTR010Y	Acc.	STR I/F pad on CVV Lower Bulkhead, -Z/+Y	X60 / clean cable
PACSTR010Z	Acc.	STR I/F pad on CVV Lower Bulkhead, -Z/+Y	X60 / clean cable

Strut MLI vs. strain gauge harness: It is foreseen to cut the S/G cables after acceptance test completion at the strut end such that the cable stays in place and the MLI does not have to be removed.

3.4 Electrical connection of strain gauges

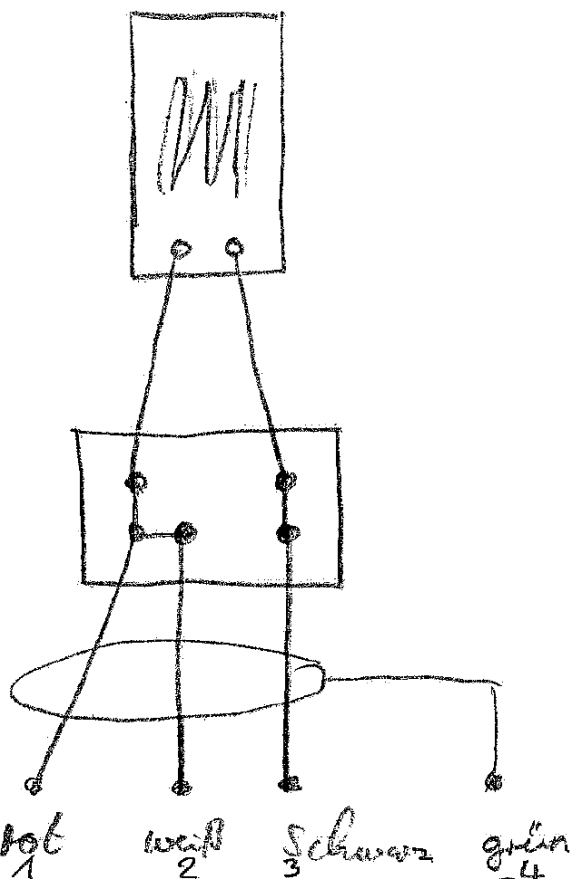
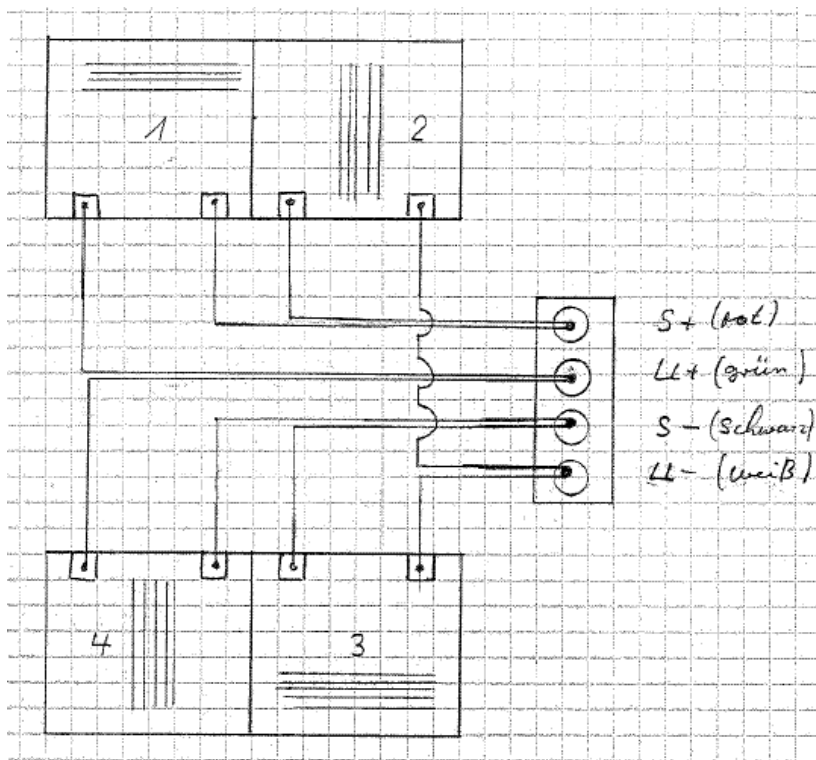

Figure 3-1: Quarter bridge schematic



Wire	Colour
Voltage Supply +	Red
Signal +	Green
Voltage Supply -	Black
Signal -	White

Figure 3-2: Full bridge schematic

3.5 Calibration Factors for strain gauges

See Annex B.

3.6 Test harness routing

It is foreseen to route all sensor cables along the satellite to an area on the SVM Upper Closure Panel in the -Y segment (to either side of the waveguides). This will allow to connect all cables to the data acquisition.

3.7 Post FM acceptance test activities

Due to schedule and access constraints, it is worthwhile to plan post-test activities well in advance. After successful test completion, the following instrumentation removal activities are necessary to put the S/C into flight configuration:

Strain-gauges:

The s/g cables shall be cut off as close as possible to the gauge. The cables shall be removed completely from the S/C. The gauges stay on the S/C, as the removal may lead to damage of the sub-structure. Those sensors are marked with "SG" in the column "flight standard" in section 4.2.

Internal accelerometers:

The test harness for internal accelerometers will be disconnected at the CVV feed-through and removed from the S/C. Flight caps will be installed and secured on the feed-throughs. Those sensors are marked with "CRYO" in the column "flight standard" in section 4.2.

External accelerometers:

As far as possible, accelerometers will be detached together with cable. Those sensors are marked with "N" in the column "flight standard" in section 4.2.

In case of poor access, the cable shall be cut off at the most suitable location and electrically grounded to avoid EMC problems. In this case, sensor and cable are specially treated for vacuum conditions prior to installation. Those sensors are marked with "Y" in the column "flight standard" in section 4.2.

In addition, HSS sensors foreseen for unit protoflight testing have to be suitable for exposure to thermal vacuum conditions (S/C FM acceptance test in LSS). Those sensors are marked with "Y" in the column "vacuum standard" in section 4.2.

Note:

The above reflects the current baseline scenario of thermal vacuum test before mechanical tests. For a reversed acceptance test sequence, the instrumentation approach must be revised.

4 Instrumentation List

4.1 Justification for deletion of STM sensors

TEL dummy: 8 channels deleted

The TEL dummy will not be used for the FM test. FM telescope instrumentation will be defined by AAS-F resp. ASEF.

Cryostat Cover: 7 channels deleted

During STM test the flight spare Cryo Cover mounted onto the flight spare CVV Top Plate was used. The loads observed during all STM tests were comfortably below the unit qualification loads. In addition, the CC sensors were never used for notch/limiter channels. Thus, for the reduced acceptance test environment, no problems are expected. The instrumentation is reduced to one tri-ax sensor close to the CC I/F to CVV to monitor overall acceleration levels.

Cryostat Baffle: 2 channels deleted

During STM test the PFM Cryo Cover mounted onto the flight spare CVV Top Plate was used. The loads observed during all STM tests were comfortably below the unit qualification loads. In addition, the CB sensors were never used for notch/limiter channels. Thus, for the reduced acceptance test environment, no problems are expected. The instrumentation is reduced to one single axis sensor on top to monitor acoustic levels.

External CVV LHe-valve sensors: 12 channels deleted

The number of additional sensors on the external helium valves introduced for the STM acoustic noise test is reduced to a reasonable level. The sensor location on the highest loaded valve is retained (PACVVV400XTO and PACVVV401XTO).

STR I/F on CVV: 3 channels deleted

The three channels on the CVV STR I/F are particularly difficult to mount and dismount due to access from the inside of the SVM cone and the MLI constraints. Since the measurements during STM indicated moderate levels and the sensors were not used for notch/limiter definitions, the sensors are proposed for deletion.

Retained sensors

Instrumentation of the following parts is to a large extent taken over from STM:

- HSS (needed to verify HSS FM)
- HSS Struts (needed to verify HSS FM)
- TMS (needed to monitor TEL loads)
- LOU (to verify LOU issues as per NC-1984)
- External CVV and SVM Thermal shield (basically no changes; needed to provide global responses; good access)

4.2 H-EPLM FM instrumentation list

MP ID	Type	Location	Direct.	Usage			Exp.	Limit	Flight	Vacuum	Remark
			X/Y/Z	Sine	A/N	μ-vib	max. lev.	def.	stand.	stand.	
Internal											
PACRYO101X	accelerometer	HTT Upper BH	X	y	y		15 g		CRYO	CRYO	Endevco 2272
PACRYO102Y	accelerometer	HTT Upper BH	Y	y	y		15 g		CRYO	CRYO	Endevco 2272
PACRYO103Z	accelerometer	HTT Upper BH	Z	y	y		15 g		CRYO	CRYO	Endevco 2272
PACRYO104X	accelerometer	HTT Lower BH	X	y	y		15 g		CRYO	CRYO	Endevco 2272
PACRYO105Y	accelerometer	HTT Lower BH	Y	y	y		15 g		CRYO	CRYO	Endevco 2272
PACRYO106Z	accelerometer	HTT Lower BH	Z	y	y		15 g		CRYO	CRYO	Endevco 2272
PACRYO107X	accelerometer	HTT Upper BH	X	y	y		15 g		CRYO	CRYO	Endevco 2272
PACRYO108Z	accelerometer	HTT Lower BH	Z	y	y		15 g		CRYO	CRYO	Endevco 2272
PACRYO109Y	accelerometer	HTT Lower BH	Y	y	y		15 g		CRYO	CRYO	Endevco 2272
PACRYO201X	accelerometer	OBA	X	y	y	y	15 g		CRYO	CRYO	Endevco 2272
PACRYO202Y	accelerometer	OBA	Y	y	y	y	15 g		CRYO	CRYO	Endevco 2272
PACRYO203Z	accelerometer	OBA	Z	y	y	y	15 g		CRYO	CRYO	Endevco 2272
PACRYO204X	accelerometer	OBA	X	y	y	y	15 g		CRYO	CRYO	Endevco 2272
PACRYO205Z	accelerometer	OBA	Z	y	y	y	15 g		CRYO	CRYO	Endevco 2272
PACRYO206Y	accelerometer	OBA	Y	y	y	y	15 g		CRYO	CRYO	Endevco 2272
PACRYO207Y	accelerometer	PACS FPU	Y	y	y		15 g		CRYO	CRYO	Endevco 2272
PACRYO208Z	accelerometer	PACS FPU	Z	y	y		15 g		CRYO	CRYO	Endevco 2272
PACRYO421X	accelerometer	1st Shield	X	y	y		15 g		CRYO	CRYO	Endevco 2272
PACRYO422Z	accelerometer	1st Shield	Z	y	y		15 g		CRYO	CRYO	Endevco 2272
PACRYO701X	accelerometer	HOT Upper BH	X	y	y		15 g		CRYO	CRYO	Endevco 2272
PACRYO702Y	accelerometer	HOT Upper BH	Y	y	y		15 g		CRYO	CRYO	Endevco 2272
PACRYO703Z	accelerometer	HOT Upper BH	Z	y	y		15 g		CRYO	CRYO	Endevco 2272
HSS Panels											
PAHSSP001X	accelerometer	Top of Sunshade	X	y	y		100 g		N	Y	DAP5--017XTO
PAHSSP001Y	accelerometer	Top of Sunshade	Y	y	y		100 g		N	Y	

MP ID	Type	Location	Direct.	Usage			Exp.	Limit	Flight	Vacuum	Remark
			X/Y/Z	Sine	A/N	μ-vib	max. lev.	def.	stand.	stand.	
PAHSSP001Z	accelerometer	Top of Sunshade	Z	y	y		100 g	100 g	N	Y	
PAHSSP002Z	accelerometer	Top of Sunshade mid-panel	Z	y	y		100 g	85 g	Y	Y	DAP5--008O
PAHSSP003O	accelerometer	-Y side of Sunshade	O	y	y		100 g		N	Y	DAP4--013O
PAHSSP004O	accelerometer	+Y side of Sunshade mid-panel	O	y	y		100 g		N	Y	DAP6--015O
PAHSSP005X	accelerometer	-Y side of Sunshade	X	y	y		100 g		N	Y	DAP4--009TO
PAHSSP005T	accelerometer	-Y side of Sunshade	T	y	y		100 g		N	Y	
PAHSSP005O	accelerometer	-Y side of Sunshade	O	y	y		100 g		N	Y	
PAHSSP006X	accelerometer	+Y side of Sunshade	X	y	y		100 g		N	Y	
PAHSSP006T	accelerometer	+Y side of Sunshade	T	y	y		100 g		N	Y	DAP6--012TO
PAHSSP006O	accelerometer	+Y side of Sunshade	O	y	y		100 g		N	Y	
PAHSSP007X	accelerometer	-Y side of Sunshade near Horizontal Stiffener	X	y	y		50 g		N	Y	no DS sensor
PAHSSP007T	accelerometer	-Y side of Sunshade near Horizontal Stiffener	T	y	y		50 g		N	Y	
PAHSSP007O	accelerometer	-Y side of Sunshade near Horizontal Stiffener	O	y	y		50 g		N	Y	
PAHSSP008Z	accelerometer	Sunshade mid panel below Horizontal Stiffener	Z	y	y		50 g		Y	Y	DAP5-002XTO
PAHSSP009T	accelerometer	+Y side of Sunshade near Horizontal Stiffener	T	y	y		50 g		N	Y	no DS sensor
PAHSSP009O	accelerometer	+Y side of Sunshade near Horizontal Stiffener	O	y	y		50 g		N	Y	
PAHSSP101X	accelerometer	-Y side of Solar Array, near upper hor.stiff.	X	y	y		50 g		N	Y	DAP1--021TO
PAHSSP101T	accelerometer	-Y side of Solar Array, near upper hor.stiff.	T	y	y		50 g		N	Y	
PAHSSP101O	accelerometer	-Y side of Solar Array, near upper hor.stiff.	O	y	y		50 g		N	Y	
PAHSSP102Y	accelerometer	Solar Array, near upper hor.stiff., mid-panel	Y	y	y		50 g		Y	Y	DAP2--023O
PAHSSP102Z	accelerometer	Solar Array, near upper hor.stiff., mid-panel	Z	y	y		50 g		Y	Y	
PAHSSP103X	accelerometer	+Y side of Solar Array, near upper hor.stiff.	X	y	y		50 g		N	Y	DAP3--025TO
PAHSSP103T	accelerometer	+Y side of Solar Array, near upper hor.stiff.	T	y	y		50 g		N	Y	
PAHSSP103O	accelerometer	+Y side of Solar Array, near upper hor.stiff.	O	y	y		50 g		N	Y	
PAHSSP104T	accelerometer	Solar Array, -Y side	T	y	y		50 g		N	Y	DAP1--011O
PAHSSP104O	accelerometer	Solar Array, -Y side	O	y	y		50 g		N	Y	
PAHSSP105Z	accelerometer	Solar Array, panel centre	Z	y	y		50 g		Y	Y	DAP2--013O

MP ID	Type	Location	Direct.	Usage			Exp. max. lev.	Limit def.	Flight stand.	Vacuum stand.	Remark
			X/Y/Z	Sine	A/N	μ-vib					
PAHSSP106T	accelerometer	Solar Array, +Y side	T	y	y		50 g		N	Y	DAP3-0015O
PAHSSP106O	accelerometer	Solar Array, +Y side	O	y	y		50 g		N	Y	
PAHSSP107X	accelerometer	Solar Array, near lower hor.stiff., -Y side, outer corner	X	y	y		50 g		N	Y	DAP1--001XTO
PAHSSP107T	accelerometer	Solar Array, near lower hor.stiff., -Y side, outer corner	T	y	y		50 g		N	Y	
PAHSSP107O	accelerometer	Solar Array, near lower hor.stiff., -Y side, outer corner	O	y	y		50 g		N	Y	
PAHSSP108X	accelerometer	Solar Array, near lower hor.stiff., +Y side, outer corner	X	y	y		50 g		N	Y	DAP3--005XTO
PAHSSP108T	accelerometer	Solar Array, near lower hor.stiff., +Y side, outer corner	T	y	y		50 g		N	Y	
PAHSSP108O	accelerometer	Solar Array, near lower hor.stiff., +Y side, outer corner	O	y	y		50 g		N	Y	
HSS Struts											
PASA-S001L	accelerometer	Solar Array Strut 01, local lateral Y	Y'	y	y		70 g		N	Y	
PASA-S001P	accelerometer	Solar Array Strut 01, local lateral Z	Z'	y	y		70 g		N	Y	
PASA-S002L	accelerometer	Solar Array Strut 02, local lateral Y	Y'	y	y		70 g		N	Y	
PASA-S002P	accelerometer	Solar Array Strut 02, local lateral Z	Z'	y	y		70 g		N	Y	
PASA-S003L	accelerometer	Solar Array Strut 03, local lateral Y	Y'	y	y		70 g		N	Y	
PASA-S003P	accelerometer	Solar Array Strut 03, local lateral Z	Z'	y	y		70 g		N	Y	
PASA-S004L	accelerometer	Solar Array Strut 04, local lateral Y	Y'	y	y		70 g		N	Y	
PASA-S004P	accelerometer	Solar Array Strut 04, local lateral Z	Z'	y	y		70 g		N	Y	
PASA-S005L	accelerometer	Solar Array Strut 05, local lateral Y	Y'	y	y		70 g		N	Y	
PASA-S005P	accelerometer	Solar Array Strut 05, local lateral Z	Z'	y	y		70 g		N	Y	
PASA-S006L	accelerometer	Solar Array Strut 06, local lateral Y	Y'	y	y		70 g		Y	Y	
PASA-S006P	accelerometer	Solar Array Strut 06, local lateral Z	Z'	y	y		70 g		Y	Y	
PASA-S007L	accelerometer	Solar Array Strut 07, local lateral Y	Y'	y	y		70 g		Y	Y	
PASA-S007P	accelerometer	Solar Array Strut 07, local lateral Z	Z'	y	y		70 g		Y	Y	
PASA-S008L	accelerometer	Solar Array Strut 08, local lateral Y	Y'	y	y		70 g		N	Y	

MP ID	Type	Location	Direct.	Usage			Exp.	Limit	Flight	Vacuum	Remark
				X/Y/Z	Sine	A/N					
PASA-S008P	accelerometer	Solar Array Strut 08, local lateral Z	Z'	y	y		70 g		N	Y	
PASSDS009L	accelerometer	Sunshade Strut 09, local lateral Y	Y'	y	y		70 g		N	Y	
PASSDS009P	accelerometer	Sunshade Strut 09, local lateral Z	Z'	y	y		70 g		N	Y	
PASSDS010L	accelerometer	Sunshade Strut 10, local lateral Y	Y'	y	y		70 g		Y	Y	
PASSDS010P	accelerometer	Sunshade Strut 10, local lateral Z	Z'	y	y		70 g		Y	Y	
PASSDS011L	accelerometer	Sunshade Strut 11, local lateral Y	Y'	y	y		70 g		Y	Y	
PASSDS011P	accelerometer	Sunshade Strut 11, local lateral Z	Z'	y	y		70 g		Y	Y	
PASSDS012L	accelerometer	Sunshade Strut 12, local lateral Y	Y'	y	y		70 g		N	Y	
PASSDS012P	accelerometer	Sunshade Strut 12, local lateral Z	Z'	y	y		70 g		N	Y	
PSSA-S011A	strain gauge	Solar Array Strut 01, 0°, axial dir.	X'	y	y				SG	SG	quarter-bridge
PSSA-S012A	strain gauge	Solar Array Strut 01, -120°, axial dir.	X'	y	y				SG	SG	quarter-bridge
PSSA-S013A	strain gauge	Solar Array Strut 01, +120°, axial dir.	X'	y	y				SG	SG	quarter-bridge
PSSA-S021A	strain gauge	Solar Array Strut 02, 0°, axial dir.	X'	y	y				SG	SG	quarter-bridge
PSSA-S022A	strain gauge	Solar Array Strut 02, -120°, axial dir.	X'	y	y				SG	SG	quarter-bridge
PSSA-S023A	strain gauge	Solar Array Strut 02, +120°, axial dir.	X'	y	y				SG	SG	quarter-bridge
PSSA-S031A	strain gauge	Solar Array Strut 03, 0°, axial dir.	X'	y	y				SG	SG	quarter-bridge
PSSA-S032A	strain gauge	Solar Array Strut 03, -120°, axial dir.	X'	y	y				SG	SG	quarter-bridge
PSSA-S033A	strain gauge	Solar Array Strut 03, +120°, axial dir.	X'	y	y				SG	SG	quarter-bridge
PSSA-S041A	strain gauge	Solar Array Strut 04, 0°, axial dir.	X'	y	y				SG	SG	quarter-bridge
PSSA-S042A	strain gauge	Solar Array Strut 04, -120°, axial dir.	X'	y	y				SG	SG	quarter-bridge
PSSA-S043A	strain gauge	Solar Array Strut 04, +120°, axial dir.	X'	y	y				SG	SG	quarter-bridge
PSSA-S051A	strain gauge	Solar Array Strut 05, 0°, axial dir.	X'	y	y				SG	SG	quarter-bridge
PSSA-S052A	strain gauge	Solar Array Strut 05, -120°, axial dir.	X'	y	y				SG	SG	quarter-bridge
PSSA-S053A	strain gauge	Solar Array Strut 05, +120°, axial dir.	X'	y	y				SG	SG	quarter-bridge
PSSA-S061A	strain gauge	Solar Array Strut 06, 0°, axial dir.	X'	y	y				SG	SG	quarter-bridge
PSSA-S062A	strain gauge	Solar Array Strut 06, -120°, axial dir.	X'	y	y				SG	SG	quarter-bridge
PSSA-S063A	strain gauge	Solar Array Strut 06, +120°, axial dir.	X'	y	y				SG	SG	quarter-bridge
PSSA-S071A	strain gauge	Solar Array Strut 07, 0°, axial dir.	X'	y	y				SG	SG	quarter-bridge

MP ID	Type	Location	Direct.	Usage			Exp.	Limit	Flight	Vacuum	Remark
			X/Y/Z	Sine	A/N	μ-vib	max. lev.	def.	stand.	stand.	
PSSA-S072A	strain gauge	Solar Array Strut 07, -120°, axial dir.	X'	y	y				SG	SG	quarter-bridge
PSSA-S073A	strain gauge	Solar Array Strut 07, +120°, axial dir.	X'	y	y				SG	SG	quarter-bridge
PSSA-S081A	strain gauge	Solar Array Strut 08, 0°, axial dir.	X'	y	y				SG	SG	quarter-bridge
PSSA-S082A	strain gauge	Solar Array Strut 08, -120°, axial dir.	X'	y	y				SG	SG	quarter-bridge
PSSA-S083A	strain gauge	Solar Array Strut 08, +120°, axial dir.	X'	y	y				SG	SG	quarter-bridge
PSSA-S091A	strain gauge	Short Solar Array Strut SB1, axial	X'	y	y				SG	SG	quarter-bridge, provided by DS
PSSA-S101A	strain gauge	Short Solar Array Strut SB2, axial	X'	y	y				SG	SG	quarter-bridge, provided by DS
PSSA-S111A	strain gauge	Short Solar Array Strut SB3, axial	X'	y	y				SG	SG	quarter-bridge, provided by DS
PSSSDS091A	strain gauge	Sunshade Strut 09, 0°, axial dir.	X'	y	y				SG	SG	quarter-bridge
PSSSDS092A	strain gauge	Sunshade Strut 09, -120°, axial dir.	X'	y	y				SG	SG	quarter-bridge
PSSSDS093A	strain gauge	Sunshade Strut 09, +120°, axial dir.	X'	y	y				SG	SG	quarter-bridge
PSSSDS101A	strain gauge	Sunshade Strut 10, 0°, axial dir.	X'	y	y				SG	SG	quarter-bridge
PSSSDS102A	strain gauge	Sunshade Strut 10, -120°, axial dir.	X'	y	y				SG	SG	quarter-bridge
PSSSDS103A	strain gauge	Sunshade Strut 10, +120°, axial dir.	X'	y	y				SG	SG	quarter-bridge
PSSSDS111A	strain gauge	Sunshade Strut 11, 0°, axial dir.	X'	y	y				SG	SG	quarter-bridge
PSSSDS112A	strain gauge	Sunshade Strut 11, -120°, axial dir.	X'	y	y				SG	SG	quarter-bridge
PSSSDS113A	strain gauge	Sunshade Strut 11, +120°, axial dir.	X'	y	y				SG	SG	quarter-bridge
PSSSDS121A	strain gauge	Sunshade Strut 12, 0°, axial dir.	X'	y	y				SG	SG	quarter-bridge
PSSSDS122A	strain gauge	Sunshade Strut 12, -120°, axial dir.	X'	y	y				SG	SG	quarter-bridge
PSSSDS123A	strain gauge	Sunshade Strut 12, +120°, axial dir.	X'	y	y				SG	SG	quarter-bridge
TEL Mounting Structure											
PATMSF001X	accelerometer	TMS Frame on corner, -Z side	X	y	y		30 g		N	N	
PATMSF001Y	accelerometer	TMS Frame on corner, -Z side	Y	y	y		30 g		N	N	
PATMSF001Z	accelerometer	TMS Frame on corner, -Z side	Z	y	y		30 g		N	N	
PATMSF002X	accelerometer	TMS Frame on corner, +Y side	X	y	y		30 g		N	N	
PATMSF002Y	accelerometer	TMS Frame on corner, +Y side	Y	y	y		30 g		N	N	

MP ID	Type	Location	Direct.	Usage			Exp. max. lev.	Limit def.	Flight stand.	Vacuum stand.	Remark
			X/Y/Z	Sine	A/N	μ-vib					
PATMSF002Z	accelerometer	TMS Frame on corner, +Y side	Z	y	y		30 g		N	N	
PATMSF003X	accelerometer	TMS Frame on corner, -Y side	X	y	y		30 g		N	N	
PATMSF003Y	accelerometer	TMS Frame on corner, -Y side	Y	y	y		30 g		N	N	
PATMSF003Z	accelerometer	TMS Frame on corner, -Y side	Z	y	y		30 g		N	N	
PSTMSS041A	strain gauge	TMS Strut, 0°, axial dir., -Z	X'	y	y				SG	SG	quarter-bridge
PSTMSS051A	strain gauge	TMS Strut, 0°, axial dir., -Z	X'	y	y				SG	SG	quarter-bridge
PSTMSS061A	strain gauge	TMS Strut, 0°, axial dir., +Y	X'	y	y				SG	SG	quarter-bridge
PSTMSS071A	strain gauge	TMS Strut, 0°, axial dir., +Y	X'	y	y				SG	SG	quarter-bridge
PSTMSS081A	strain gauge	TMS Strut, 0°, axial dir., -Y	X'	y	y				SG	SG	quarter-bridge
PSTMSS091A	strain gauge	TMS Strut, 0°, axial dir., -Y	X'	y	y				SG	SG	quarter-bridge
PSTMSS101A	strain gauge	TMS CB Strut, 0°/180°, T-rosette 0/90	X'	y	y				SG	SG	full-bridge, bending compensated
PSTMSS111A	strain gauge	TMS CB Strut, 0°/180°, T-rosette 0/90	X'	y	y				SG	SG	full-bridge, bending compensated
LOU											
PALOUS001X	accelerometer	LOU CoG position	X	y	y		70 g		N	N	
PALOUS001Y	accelerometer	LOU CoG position	Y	y	y		70 g		N	N	
PALOUS001Z	accelerometer	LOU CoG position	Z	y	y		70 g		N	N	
PALOUS002X	accelerometer	LOU Baffle I/F position	X	y	y		70 g		N	N	
PALOUS002Y	accelerometer	LOU Baffle I/F position	Y	y	y		70 g		N	N	
PALOUS002Z	accelerometer	LOU Baffle I/F position	Z	y	y		70 g		N	N	
PALOUR002X	accelerometer	LOU Radiator CoG position	X	y	y		70 g		N	N	moved to hard point as for STM
PALOUR002Y	accelerometer	LOU Radiator CoG position	Y	y	y		70 g		N	N	
PALOUR002Z	accelerometer	LOU Radiator CoG position	Z	y	y		70 g		N	N	
PALOUR0030	accelerometer	LOU Radiator Corner local oop	oop (local)	y	y		100 g		N	N	
PSLOUS011A	strain gauge	LOU Strut, 0°/180°, T-rosette 0/90	X'	y	y				SG	SG	NEW positioning!!!
PSLOUS021A	strain gauge	LOU Strut, 0°/180°, T-rosette 0/90	X'	y	y				SG	SG	full-bridge, bending compensated

MP ID	Type	Location	Direct. X/Y/Z	Usage			Exp. max. lev.	Limit def.	Flight stand.	Vacuum stand.	Remark
				Sine	A/N	μ-vib					
PSLOUS031A	strain gauge	LOU Strut, 0°/180°, T-rosette 0/90	X'	y	y				SG	SG	full-bridge, bending compensated
PSLOUS041A	strain gauge	LOU Strut, 0°/180°, T-rosette 0/90	X'	y	y				SG	SG	full-bridge, bending compensated
PSLOUS051A	strain gauge	LOU Strut, 0°/180°, T-rosette 0/90	X'	y	y				SG	SG	full-bridge, bending compensated
PSLOUS061A	strain gauge	LOU Strut, 0°/180°, T-rosette 0/90	X'	y	y				SG	SG	full-bridge, bending compensated
PSLOUS071A	strain gauge	LOU Strut, 0°/180°, T-rosette 0/90	X'	y	y				SG	SG	full-bridge, bending compensated
PSLOUS081A	strain gauge	LOU Strut, 0°/180°, T-rosette 0/90	X'	y	y				SG	SG	full-bridge, bending compensated
SVM/PLM Struts											
PSSVMS011A	strain gauge	SVM Strut +Y, 0°, axial dir.	X'	y	y				SG	SG	quarter-bridge
PSSVMS012A	strain gauge	SVM Strut +Y, -120°, axial dir.	X'						SG	SG	quarter-bridge, contingency
PSSVMS013A	strain gauge	SVM Strut +Y, +120°, axial dir.	X'						SG	SG	quarter-bridge, contingency
PSSVMS021A	strain gauge	SVM Strut +Y, 0°, axial dir.	X'	y	y				SG	SG	quarter-bridge
PSSVMS022A	strain gauge	SVM Strut +Y, -120°, axial dir.	X'						SG	SG	quarter-bridge, contingency
PSSVMS023A	strain gauge	SVM Strut +Y, +120°, axial dir.	X'						SG	SG	quarter-bridge, contingency
PSSVMS031A	strain gauge	SVM Strut -Y, 0°, axial dir.	X'	y	y				SG	SG	quarter-bridge
PSSVMS032A	strain gauge	SVM Strut -Y, -120°, axial dir.	X'						SG	SG	gauge broken, no signal
PSSVMS033A	strain gauge	SVM Strut -Y, +120°, axial dir.	X'						SG	SG	quarter-bridge, contingency
PSSVMS041A	strain gauge	SVM Strut -Y, 0°, axial dir.	X'	y	y				SG	SG	quarter-bridge
PSSVMS042A	strain gauge	SVM Strut -Y, -120°, axial dir.	X'						SG	SG	quarter-bridge, contingency
PSSVMS043A	strain gauge	SVM Strut -Y, +120°, axial dir.	X'						SG	SG	quarter-bridge, contingency
PSSVMS051A	strain gauge	SVM Strut +Z, 0°, axial dir.	X'	y	y				SG	SG	quarter-bridge
PSSVMS052A	strain gauge	SVM Strut +Z, -120°, axial dir.	X'						SG	SG	quarter-bridge, contingency
PSSVMS053A	strain gauge	SVM Strut +Z, +120°, axial dir.	X'						SG	SG	quarter-bridge, contingency
PSSVMS061A	strain gauge	SVM Strut +Z, 0°, axial dir.	X'	y	y				SG	SG	quarter-bridge
PSSVMS062A	strain gauge	SVM Strut +Z, -120°, axial dir.	X'						SG	SG	quarter-bridge, contingency

MP ID	Type	Location	Direct. X/Y/Z	Usage			Exp. max. lev.	Limit def.	Flight stand.	Vacuum stand.	Remark
				Sine	A/N	μ-vib					
PSSVMS063A	strain gauge	SVM Strut +Z, +120°, axial dir.	X'					SG	SG	quarter-bridge, contingency	
PSSVMS071A	strain gauge	SVM Strut -Z, 0°, axial dir.	X'	y	y			SG	SG	quarter-bridge	
PSSVMS072A	strain gauge	SVM Strut -Z, -120°, axial dir.	X'					SG	SG	quarter-bridge, contingency	
PSSVMS073A	strain gauge	SVM Strut -Z, +120°, axial dir.	X'					SG	SG	quarter-bridge, contingency	
PSSVMS081A	strain gauge	SVM Strut -Z, 0°, axial dir.	X'	y	y			SG	SG	quarter-bridge	
PSSVMS082A	strain gauge	SVM Strut -Z, -120°, axial dir.	X'					SG	SG	quarter-bridge, contingency	
PSSVMS083A	strain gauge	SVM Strut -Z, +120°, axial dir.	X'					SG	SG	quarter-bridge, contingency	
External CVV											
PACVVU001X	accelerometer	Upper CVV Ring, -Y position, STA 2222	X	y	y		15 g		N	N	
PACVVU001Z	accelerometer	Upper CVV Ring, -Y position, STA 2222	Z	y	y		15 g		N	N	
PACVVU002X	accelerometer	Upper CVV Ring, -Z position, STA 2222	X	y	y		15 g		N	N	
PACVVU002Y	accelerometer	Upper CVV Ring, -Z position, STA 2222	Y	y	y		15 g		N	N	
PACVVU003X	accelerometer	Upper CVV Ring, +Y position, STA 2222	X	y	y		15 g		N	N	
PACVVU003Z	accelerometer	Upper CVV Ring, +Y position, STA 2222	Z	y	y		15 g		N	N	
PACVVU004X	omitted	Upper CVV Ring, +Z position, STA 2222	X				15 g				position not accessible on FM
PACVVU004Y	omitted	Upper CVV Ring, +Z position, STA 2222	Y				15 g				position not accessible on FM
PACVVB005X	accelerometer	Cryostat Baffle I/F near Solar Array Strut	X	y	y		15 g		N	N	
PACVVB005Y	accelerometer	Cryostat Baffle I/F near Solar Array Strut	Y	y	y		15 g		N	N	
PACVVB005Z	accelerometer	Cryostat Baffle I/F near Solar Array Strut	Z	y	y		15 g		N	N	
PACVVL006X	accelerometer	Lower CVV Ring, -Y position, STA 544	X	y	y		15 g		N	N	
PACVVL006Z	accelerometer	Lower CVV Ring, -Y position, STA 544	Z	y	y		15 g		N	N	
PACVVL007X	accelerometer	Lower CVV Ring, -Z position, STA 544	X	y	y		15 g		N	N	
PACVVL007Y	accelerometer	Lower CVV Ring, -Z position, STA 544	Y	y	y		15 g		N	N	
PACVVL008X	accelerometer	Lower CVV Ring, +Y position, STA 544	X	y	y		15 g		N	N	
PACVVL008Z	accelerometer	Lower CVV Ring, +Y position, STA 544	Z	y	y		15 g		N	N	
PACVVL009X	omitted	Lower CVV Ring, +Z position, STA 544	X				15 g				position not accessible on FM
PACVVL009Y	omitted	Lower CVV Ring, +Z position, STA 544	Y				15 g				position not accessible on FM
PACSTR010X	omitted	STR I/F pad on CVV Lower Bulkhead, -Z/+Y	X				15 g				position not accessible on FM

MP ID	Type	Location	Direct. X/Y/Z	Usage			Exp. max. lev.	Limit def.	Flight stand.	Vacuum stand.	Remark
				Sine	A/N	μ-vib					
PACSTR010Y	omitted	STR I/F pad on CVV Lower Bulkhead, -Z/+Y	Y				15 g				position not accessible on FM
PACSTR010Z	omitted	STR I/F pad on CVV Lower Bulkhead, -Z/+Y	Z				15 g				position not accessible on FM
PACVVR0010	accelerometer	CVV -Z/+X Radiator, CoG position	oop (local)	y	y		100 g		N	N	
PACVVR0020	accelerometer	CVV -Z/-X Radiator, CoG position	oop (local)	y	y		100 g		N	N	
PACVVR0030	accelerometer	CVV +Y/+X Radiator, CoG position	oop (local)	y	y		100 g		N	N	
PACVVR0040	accelerometer	CVV +Y/-X Radiator, CoG position	oop (local)	y	y		100 g		N	N	
PACVVR0050	accelerometer	CVV -Y/+X Radiator, CoG position	oop (local)	y	y		100 g		N	N	
PACVVR0060	accelerometer	CVV -Y/-X Radiator, CoG position	oop (local)	y	y		100 g		N	N	
PACCRM003X	omitted	Cryo Cover release mechanism	X				30 g				position not accessible on FM
PACCRM003Y	omitted	Cryo Cover release mechanism	Y				30 g				position not accessible on FM
PACCCV031X	accelerometer	Cryo Cover CVV I/F (Pilot 31 @ AAE test)	X	y	y		30 g		Y	Y	
PACCCV031Y	accelerometer	Cryo Cover CVV I/F (Pilot 31 @ AAE test)	Y	y	y		30 g		Y	Y	
PACCCV031Z	accelerometer	Cryo Cover CVV I/F (Pilot 31 @ AAE test)	Z	y	y		30 g		Y	Y	
PACCCV032X	omitted	Cryo Cover CVV I/F (Pilot 32 @ AAE test)	X				30 g				position not accessible on FM
PACCCV032Y	omitted	Cryo Cover CVV I/F (Pilot 32 @ AAE test)	Y				30 g				position not accessible on FM
PACCCV032Z	omitted	Cryo Cover CVV I/F (Pilot 32 @ AAE test)	Z				30 g				position not accessible on FM
PACCYO006X	omitted	Cryo Cover yoke	X				30 g				position not accessible on FM
PACCJC008Y	omitted	Cryo Cover Johnston coupling	Y				70 g				position not accessible on FM
PACBAF0010	omitted	Cryostat Baffle, +Y, position near I/F	oop (local)				50 g				position not accessible on FM
PACBAF0020	omitted	Cryostat Baffle, -Z, position near I/F	oop (local)				50 g				position not accessible on FM
PACBAF0110	accelerometer	Cryostat Baffle cone area, -Z	oop (local)	y	y		100 g		N	N	
PANOZL001X	accelerometer	Nozzle Bracket	X	y	y		50 g		N	N	

MP ID	Type	Location	Direct.	Usage			Exp.	Limit	Flight	Vacuum	Remark
				X/Y/Z	Sine	A/N					
PANOZL001Y	accelerometer	Nozzle Bracket	Y	y	y		50 g		N	N	
PACVVV1000	omitted	CVV Valve Bracket 1	O				50 g				not needed
PACVVV101X	omitted	CVV Valve Body 1	X				50 g				not needed
PACVVV101T	omitted	CVV Valve Body 1	T				50 g				not needed
PACVVV1010	omitted	CVV Valve Body 1	O				50 g				not needed
PACVVV001X	omitted	CVV Valve Bracket 2	X				50 g				not needed
PACVVV001T	omitted	CVV Valve Bracket 2	T				50 g				not needed
PACVVV0010	omitted	CVV Valve Bracket 2	O				50 g				not needed
PACVVV201X	omitted	CVV Valve Body 2	X				50 g				not needed
PACVVV201T	omitted	CVV Valve Body 2	T				50 g				not needed
PACVVV2010	omitted	CVV Valve Body 2	O				50 g				not needed
PACVVV3000	omitted	CVV Valve Bracket 3	O				50 g				not needed
PACVVV301X	omitted	CVV Valve Body 3	X				50 g				not needed
PACVVV301T	omitted	CVV Valve Body 3	T				50 g				not needed
PACVVV3010	omitted	CVV Valve Body 3	O				50 g				not needed
PACVVV400X	accelerometer	CVV Valve Bracket 4	X	y	y		50 g		N	N	
PACVVV400T	accelerometer	CVV Valve Bracket 4	T	y	y		50 g		N	N	
PACVVV4000	accelerometer	CVV Valve Bracket 4	O	y	y		50 g		N	N	
PACVVV401X	accelerometer	CVV Valve Body 4	X	y	y		50 g		N	N	
PACVVV401T	accelerometer	CVV Valve Body 4	T	y	y		50 g		N	N	
PACVVV4010	accelerometer	CVV Valve Body 4	O	y	y		50 g		N	N	
PAWAVG001Y	accelerometer	Waveguide	Y	y	y		200 g		N	N	
PAWAVG001Z	accelerometer	Waveguide	Z	y	y		200 g		N	N	
PAWAVG002X	accelerometer	Waveguide Bracket	X	y	y		100 g		N	N	
PAWAVG002Y	accelerometer	Waveguide Bracket	Y	y	y		100 g		N	N	
PAWAVG002Z	accelerometer	Waveguide Bracket	Z	y	y		100 g		N	N	
SVM Thermal Shield											
PASVTS001X	accelerometer	SVM Thermal Shield, over strut support	X	y	y		100 g		N	N	LP5X from unit test

MP ID	Type	Location	Direct.	Usage			Exp.	Limit	Flight	Vacuum	Remark
			X/Y/Z	Sine	A/N	μ-vib	max. lev.	def.	stand.	stand.	
PASVTS001Y	accelerometer	SVM Thermal Shield, over strut support	Y	y	y		100 g		N	N	
PASVTS001Z	accelerometer	SVM Thermal Shield, over strut support	Z	y	y		100 g		N	N	
PASVTS002X	accelerometer	SVM Thermal Shield, -Y side	X	y	y		100 g		N	N	LP2X from unit test
PASVTS002Y	accelerometer	SVM Thermal Shield, -Y side	Y	y	y		100 g		N	N	
PASVTS002Z	accelerometer	SVM Thermal Shield, -Y side	Z	y	y		100 g		N	N	
PASVTS003X	accelerometer	SVM Thermal Shield, +Y side	X	y	y		100 g		N	N	between RP4X, RP5X
PASVTS003Y	accelerometer	SVM Thermal Shield, +Y side	Y	y	y		100 g		N	N	
PASVTS003Z	accelerometer	SVM Thermal Shield, +Y side	Z	y	y		100 g		N	N	
Telescope: Definition by ASEF/AAS-F											

Measurement points statistics

Installed sensors (not all will be used):

Total EPLM overall:	228
Total accelerometers:	149
Total strain gauge:	79

Channels foreseen per test:

	Sine	A/N	μ -vibe
Total EPLM:	212	212	6
Total acc:	149	149	6
Total s/g:	63	63	0
SVM & TEL (tbc):	150	150	15
Acc. total	299	299	
Total FM:	362	362	21

Post test access:

Cryo-accelerometers	22	Cryostat internal; no access
Flight accelerometers & cable	16	No access; to remain for flight
Non-flight, vacuum suitable	48	LSS suitable; removed after test
Non-flight, non vacuum	63	Not for LSS; removed after test
Straingauge	79	Cable to be removed

5 Annex A: Position of Measurement Points

5.1 Internal Cryostat Accelerometers

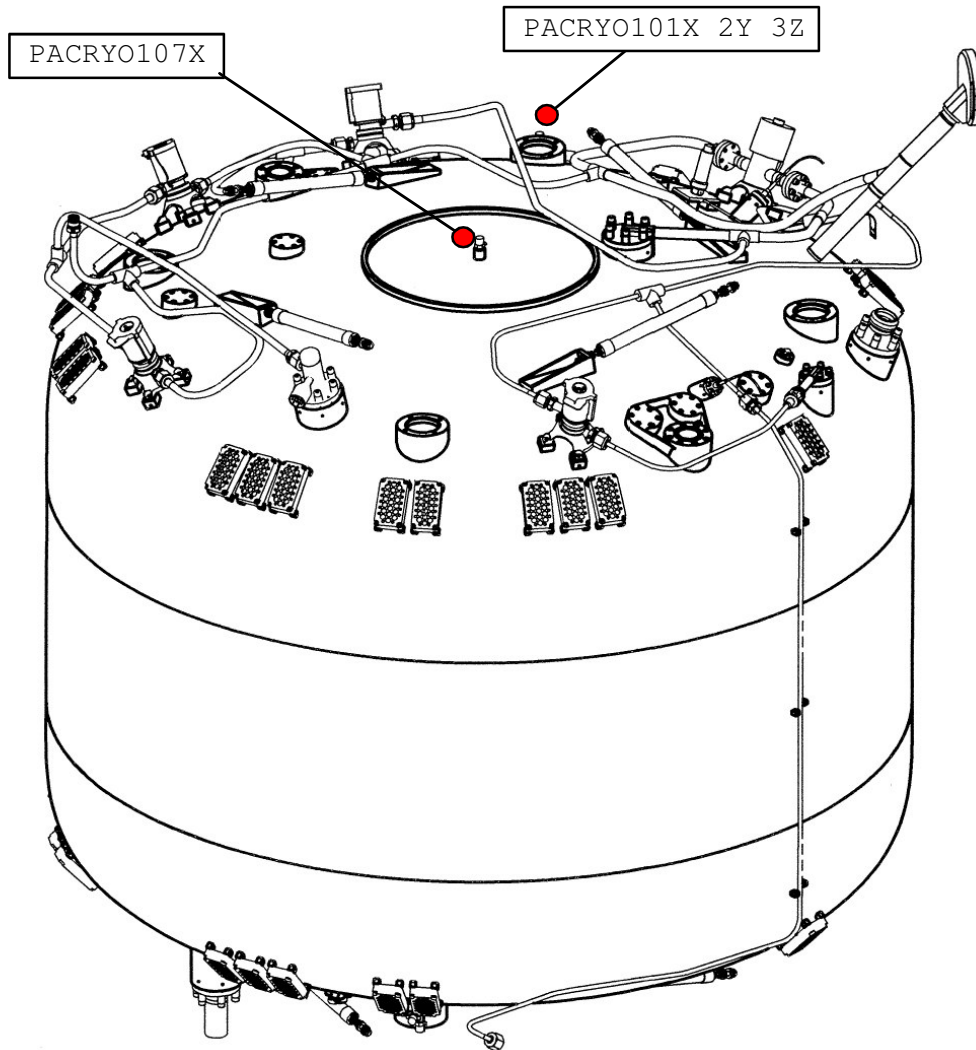

Figure 5-1: HTT accelerometers

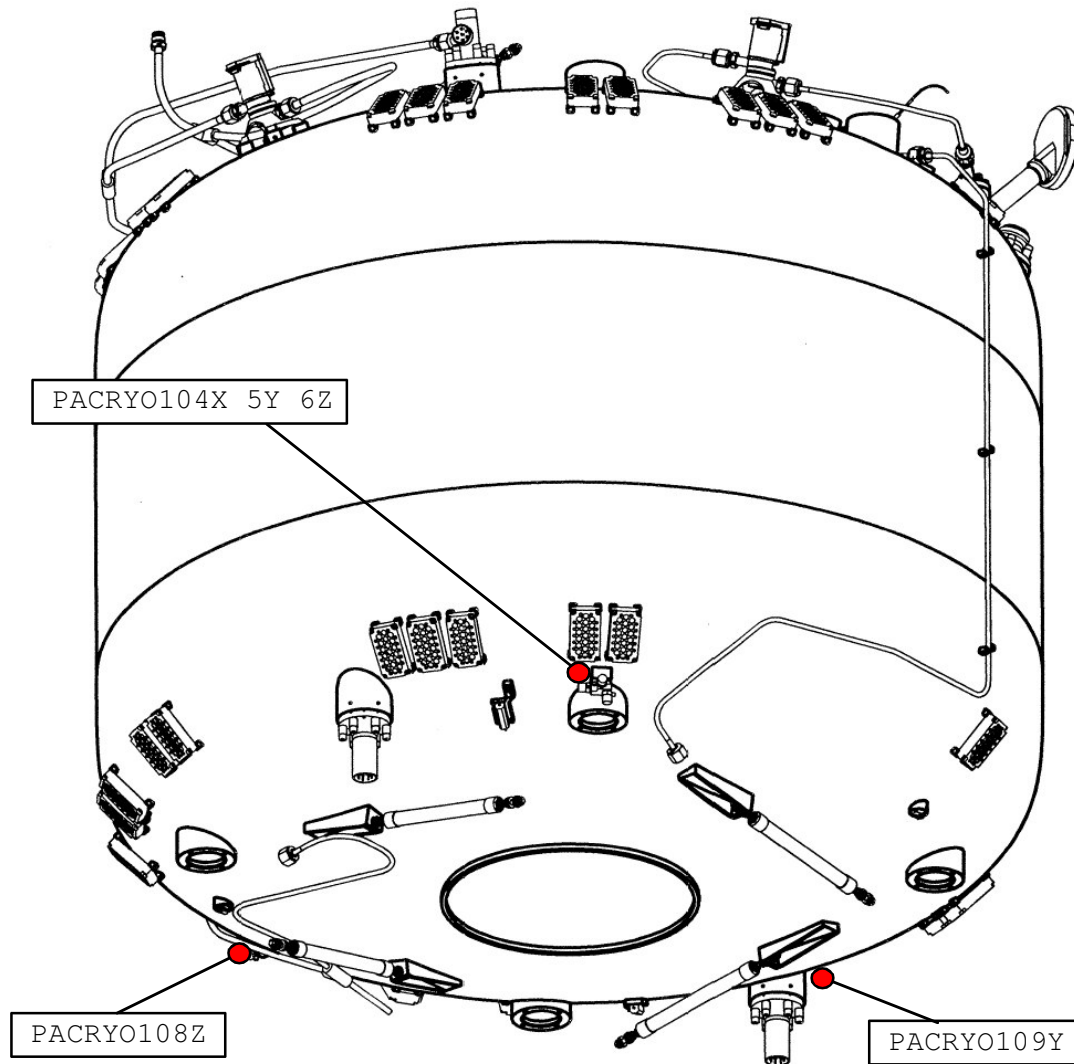

Figure 5-2: HTT accelerometers (cont)

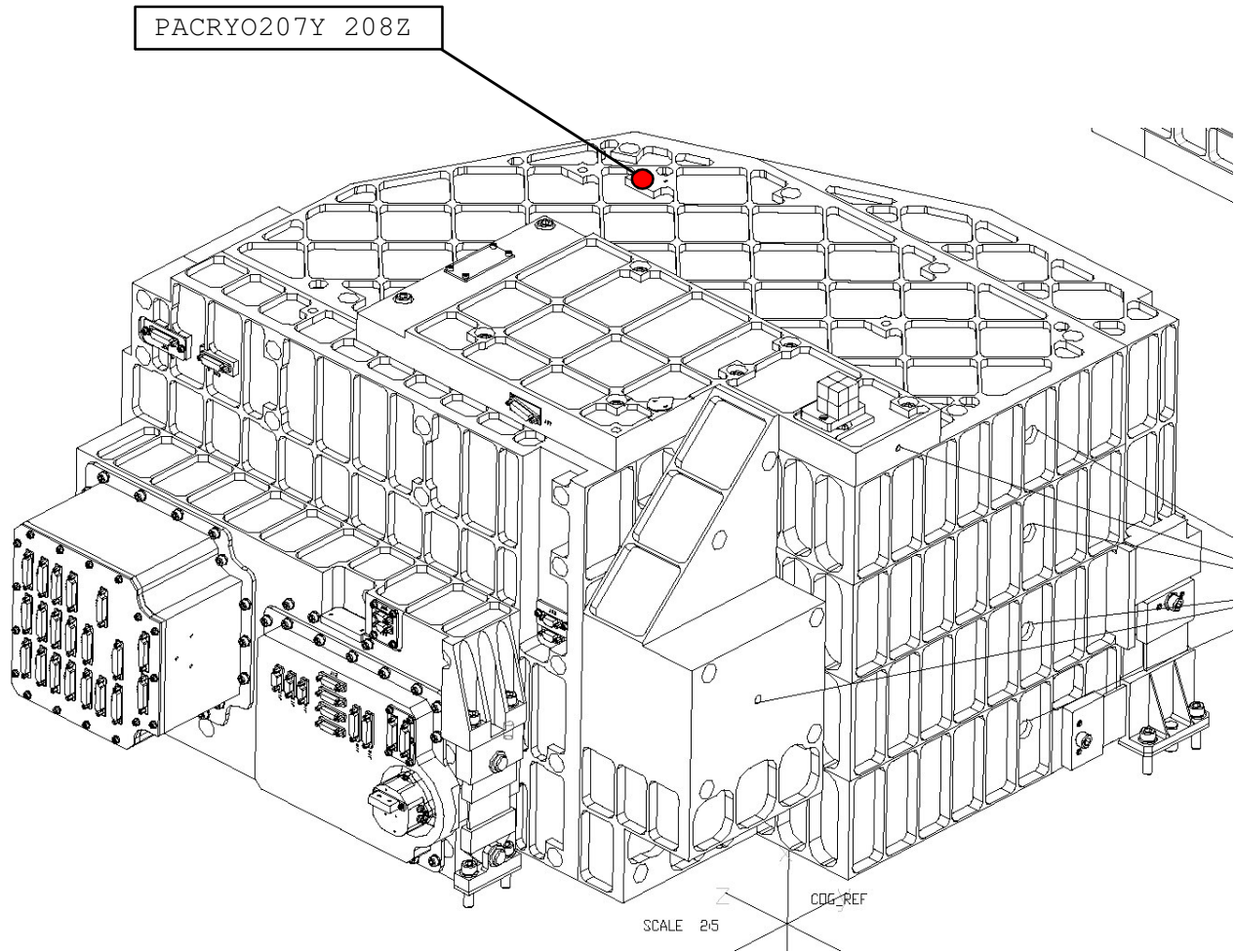

Figure 5-4: PACS FPU sensor position

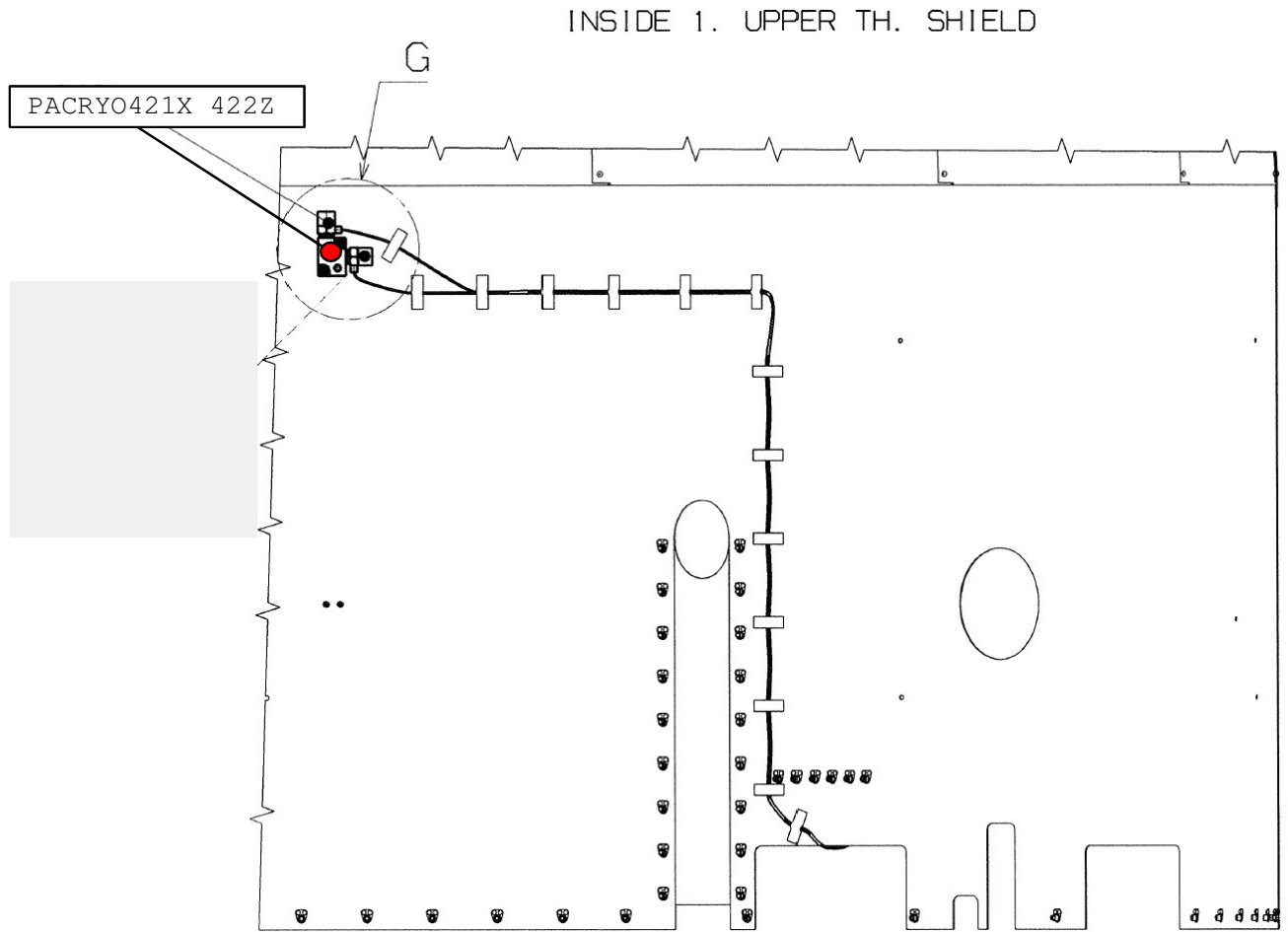

Figure 5-5: TS1 Upper Bulkhead

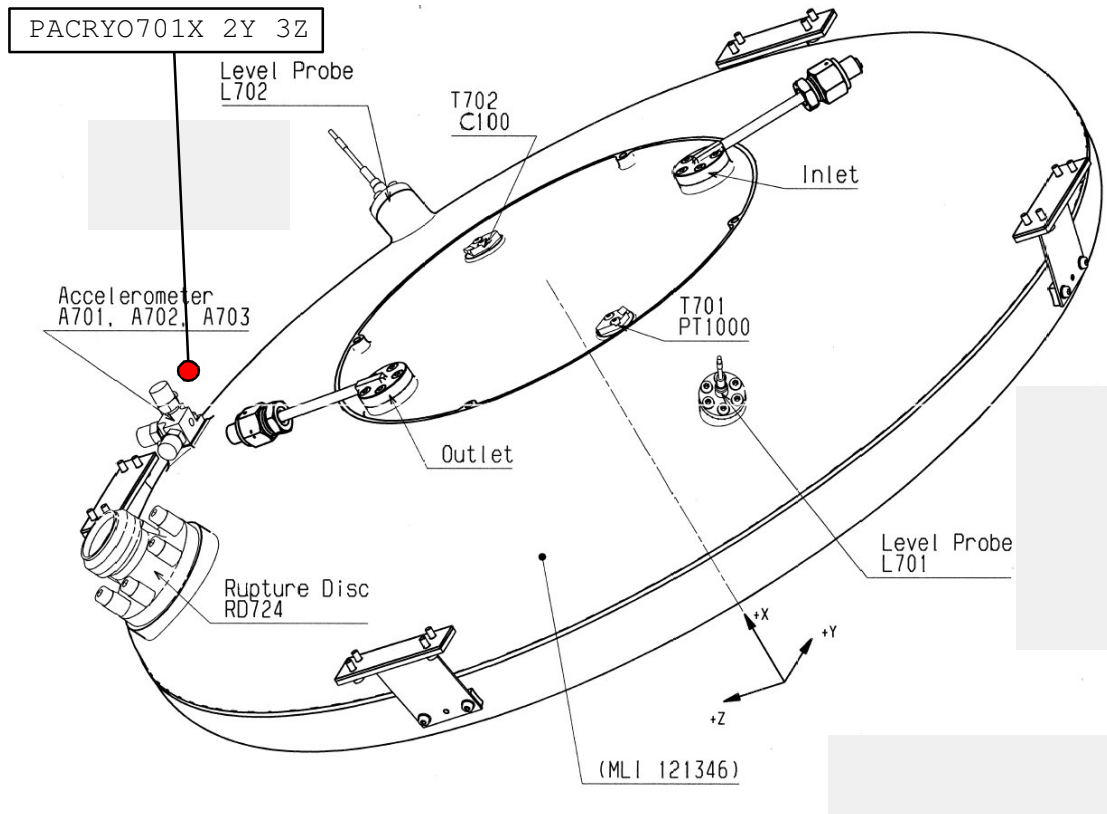

Figure 5-6: HOT accelerometers

5.2 HSS instrumentation

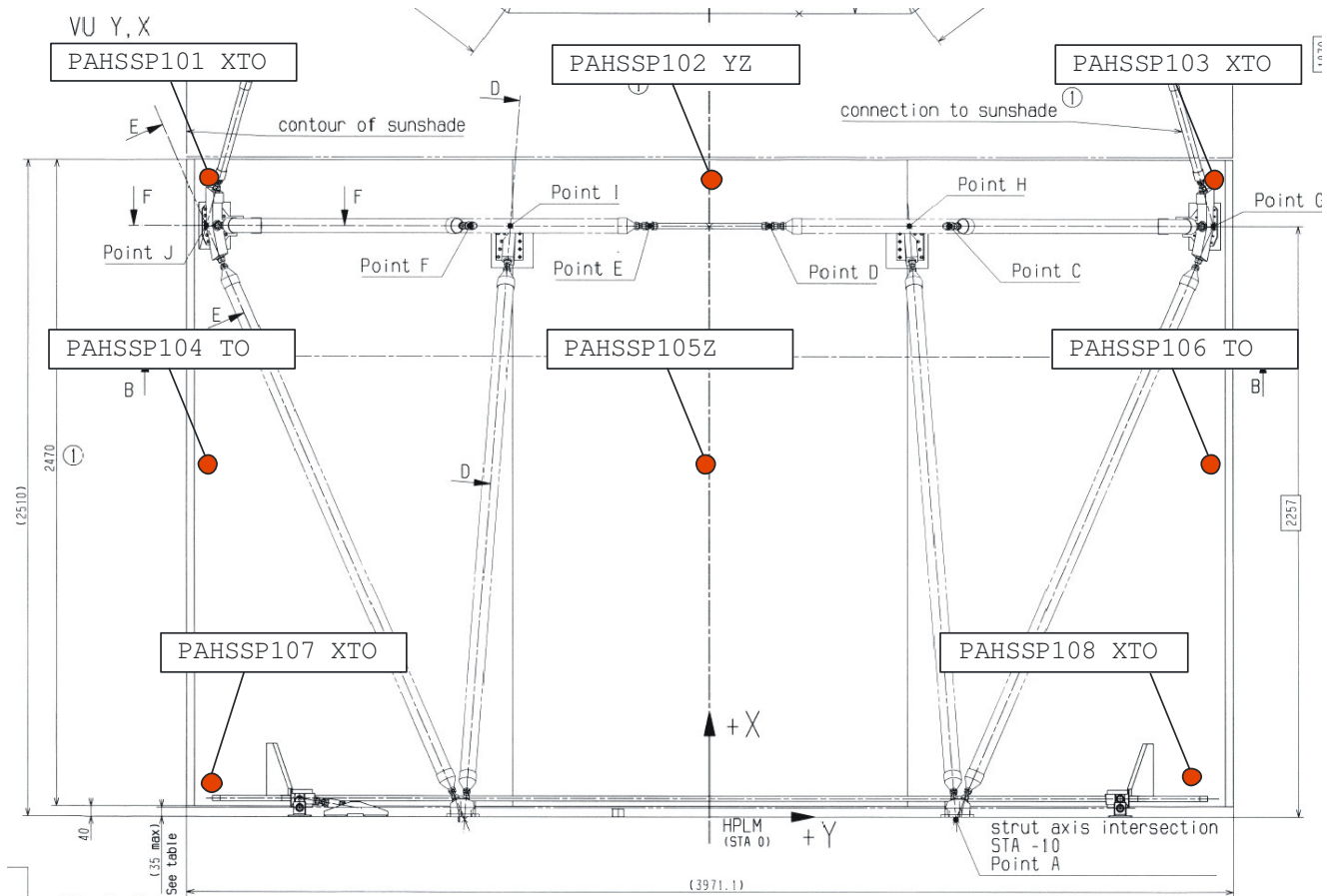

Figure 5-7: Solar Array Panels

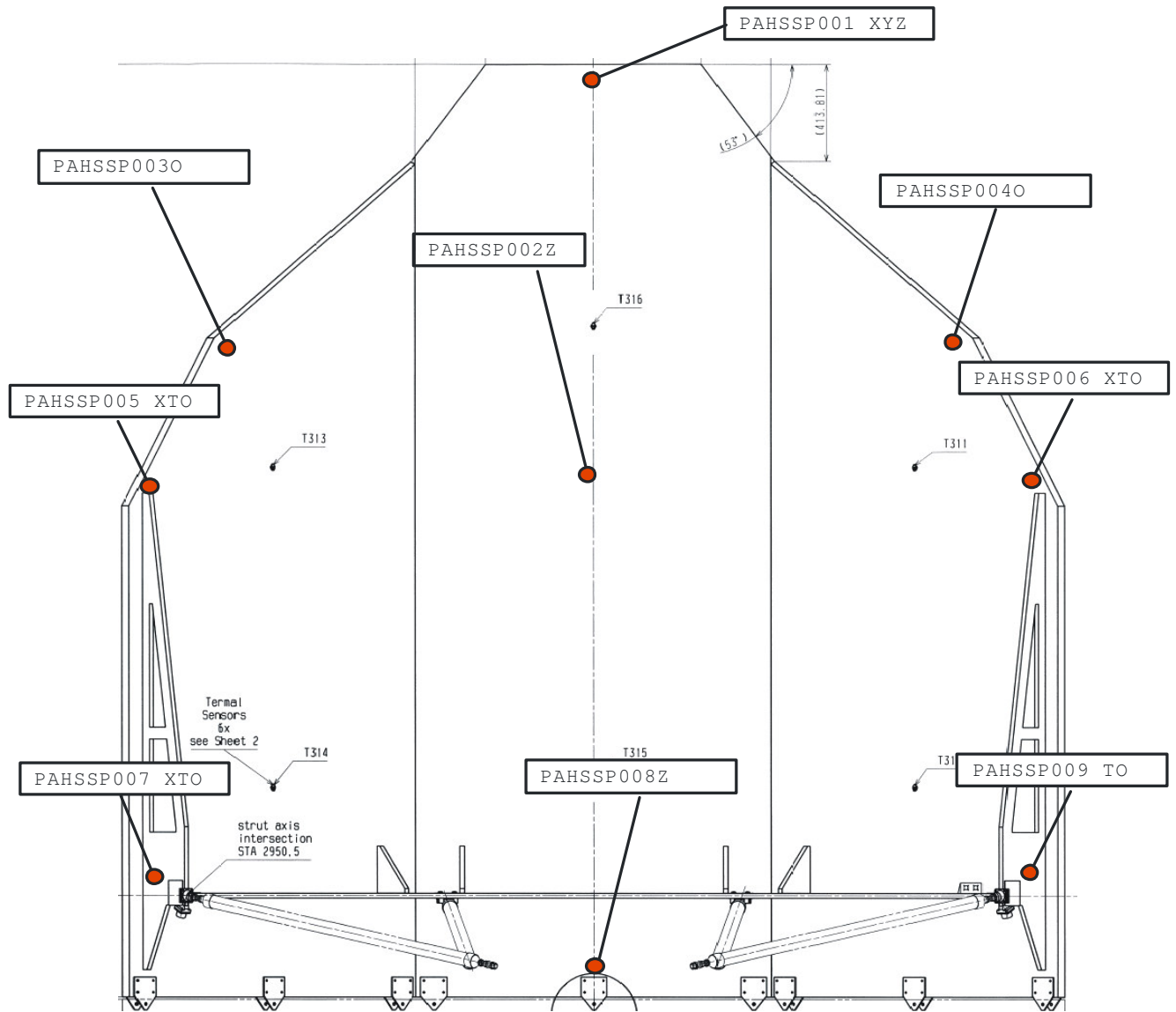

Figure 5-8: Sunshade Panels

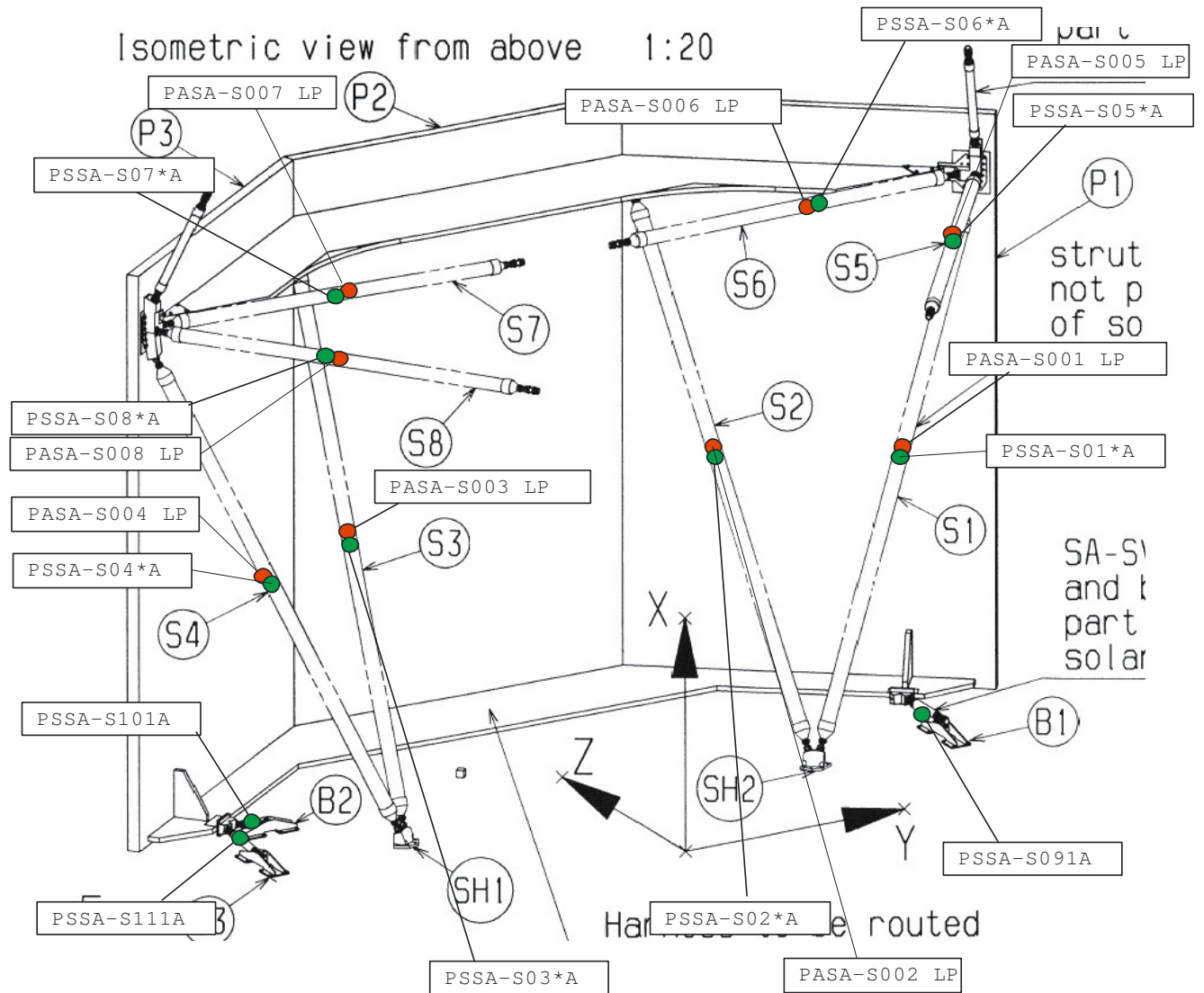

Figure 5-9: Solar Array Struts

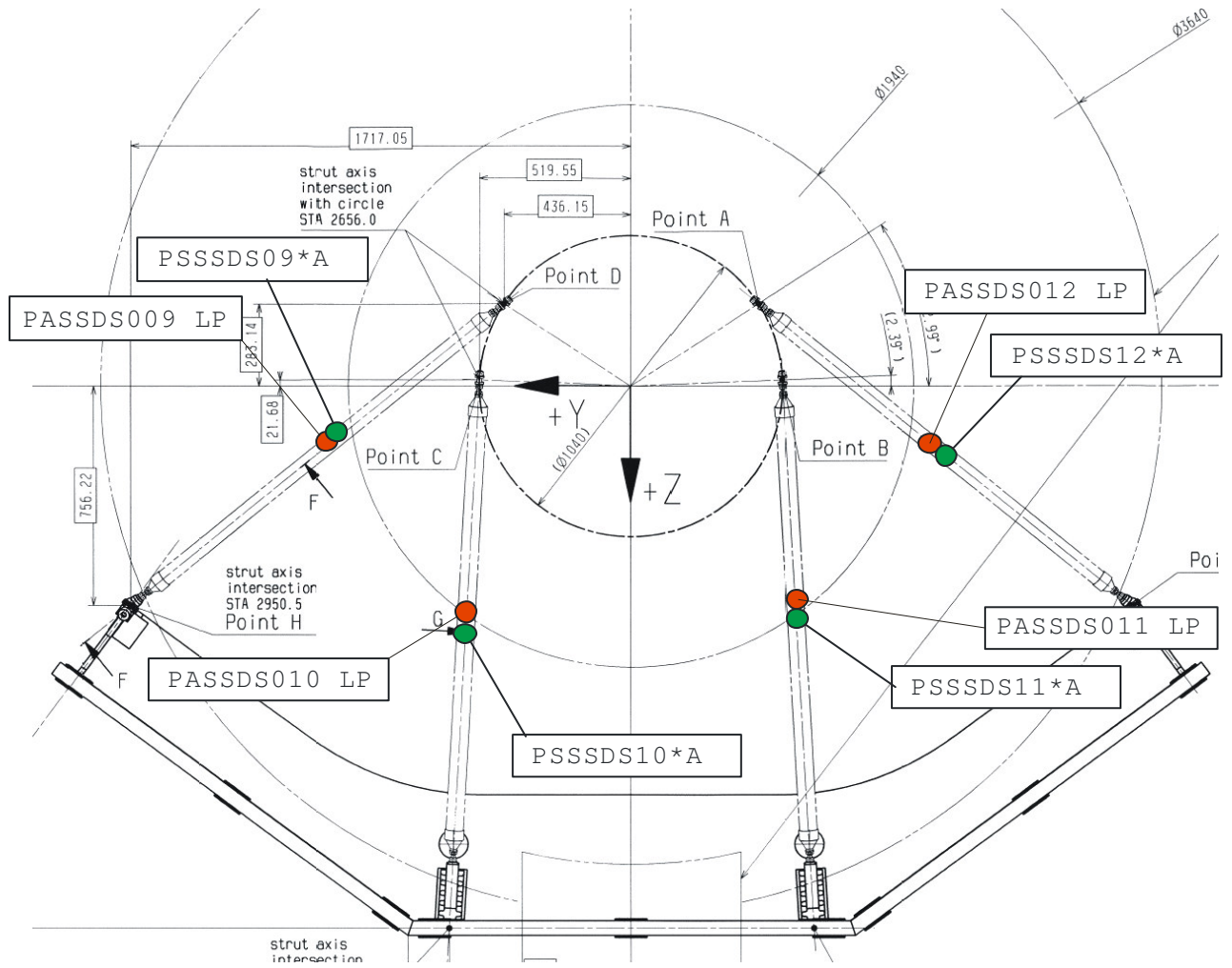

Figure 5-10: Sunshade Struts

5.3 External EPLM instrumentation

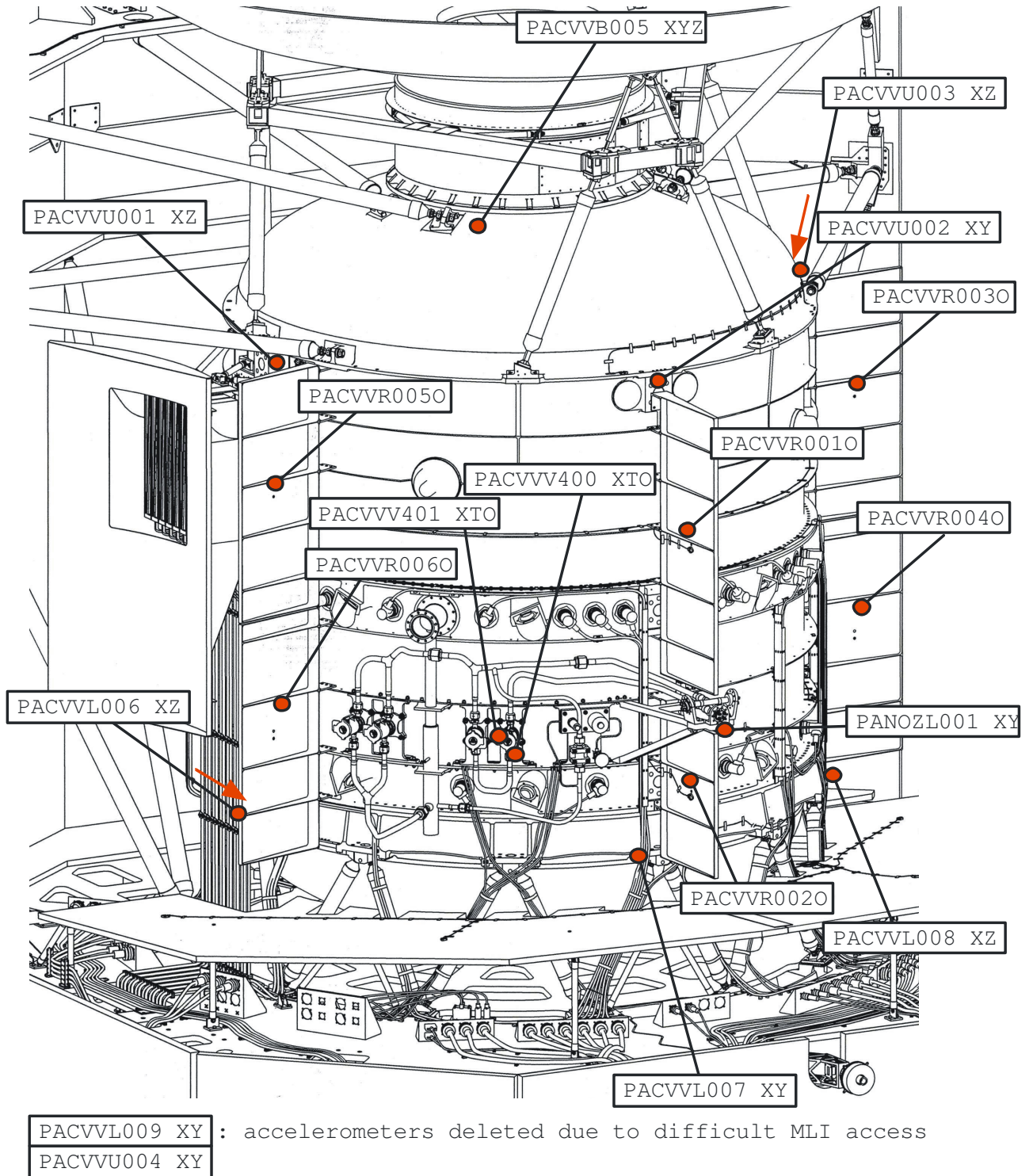

Figure 5-11: CVV external accelerometers

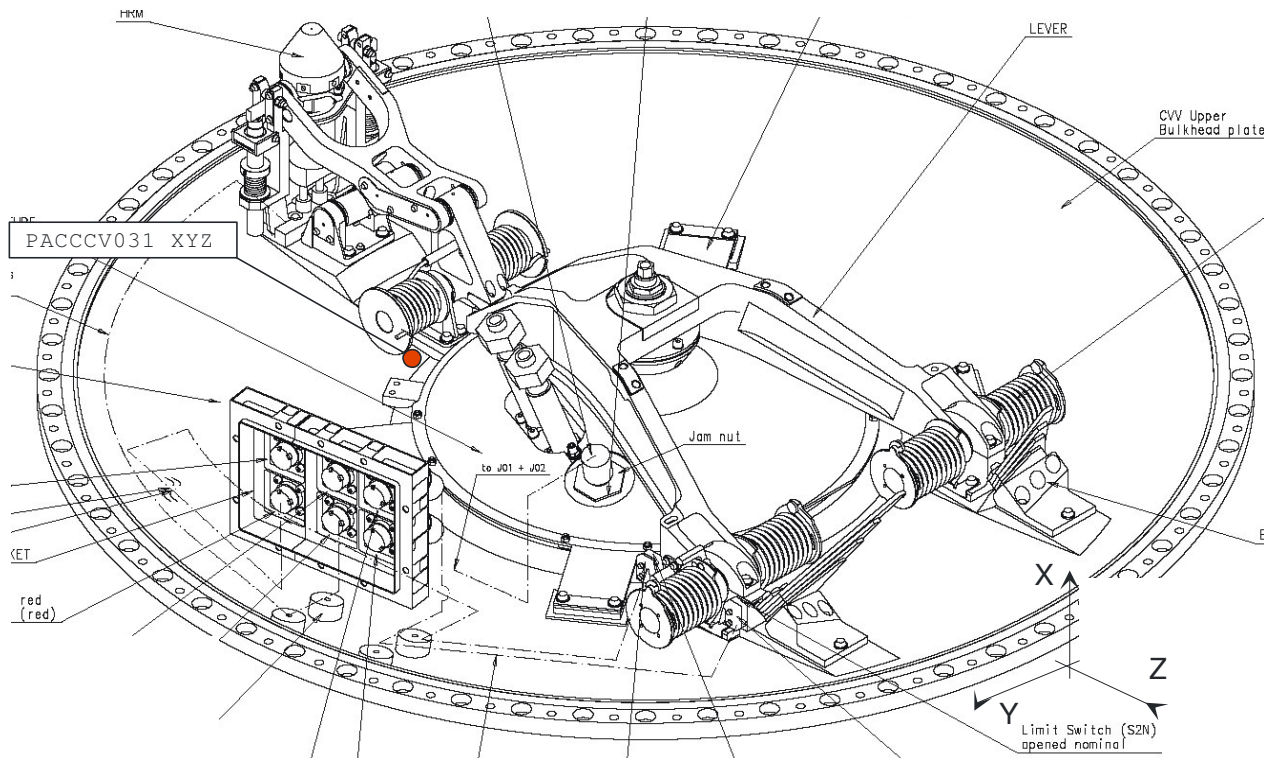
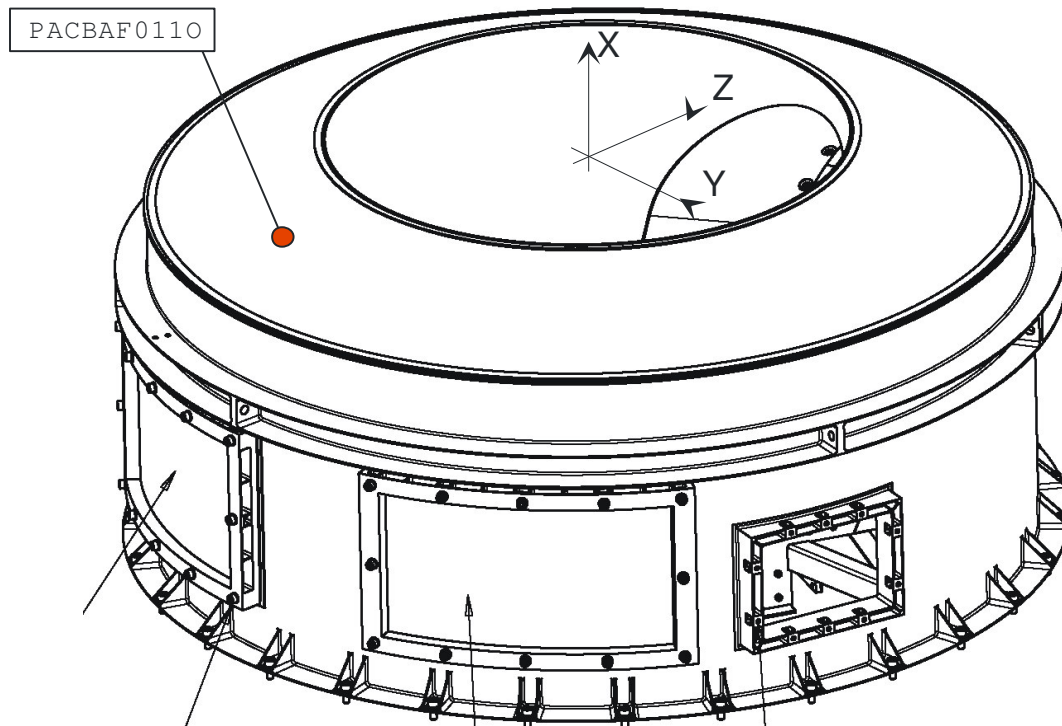

Figure 5-12: Cryostat Cover



For I/F see also: PACVVB005 XYZ

Figure 5-13: Cryostat Baffle

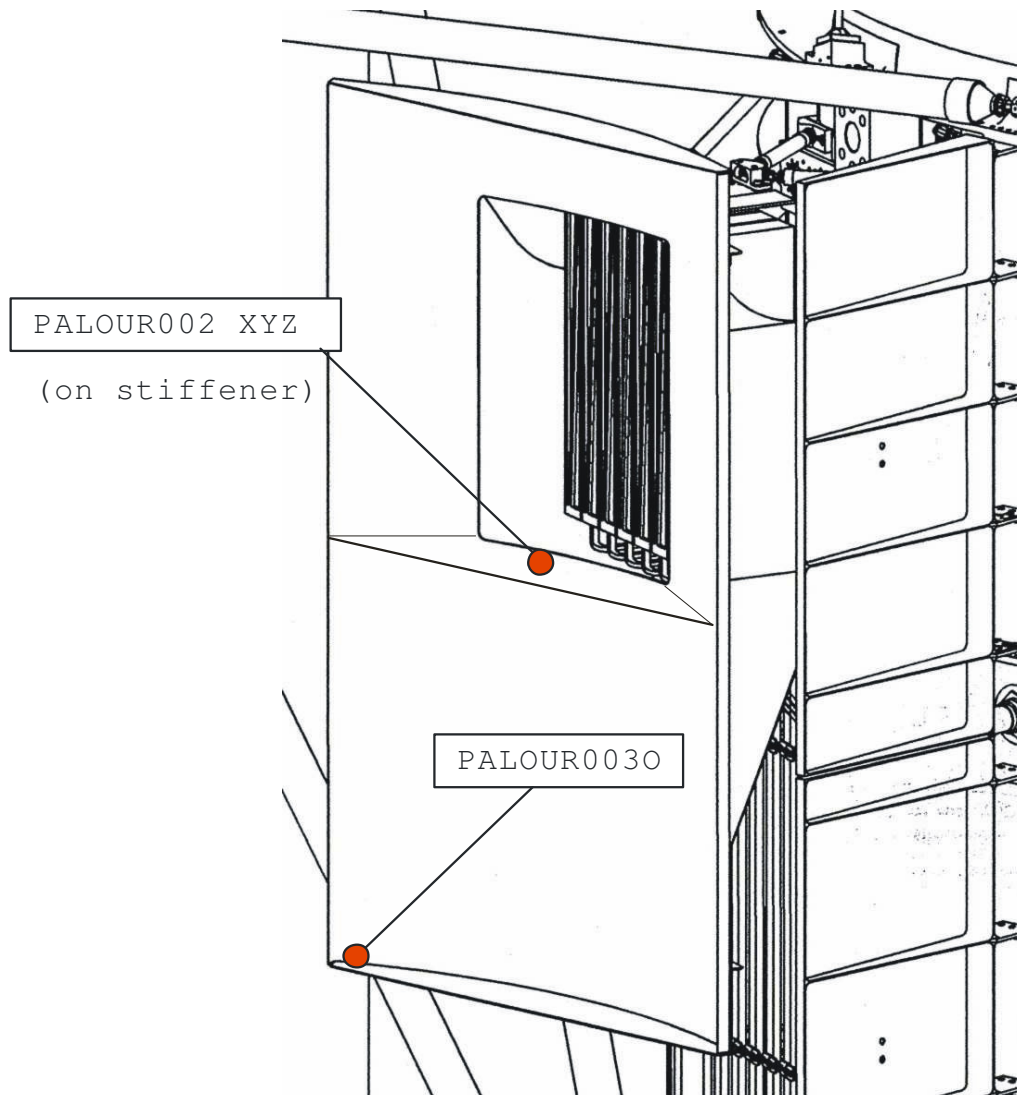

Figure 5-14: LOU Radiator

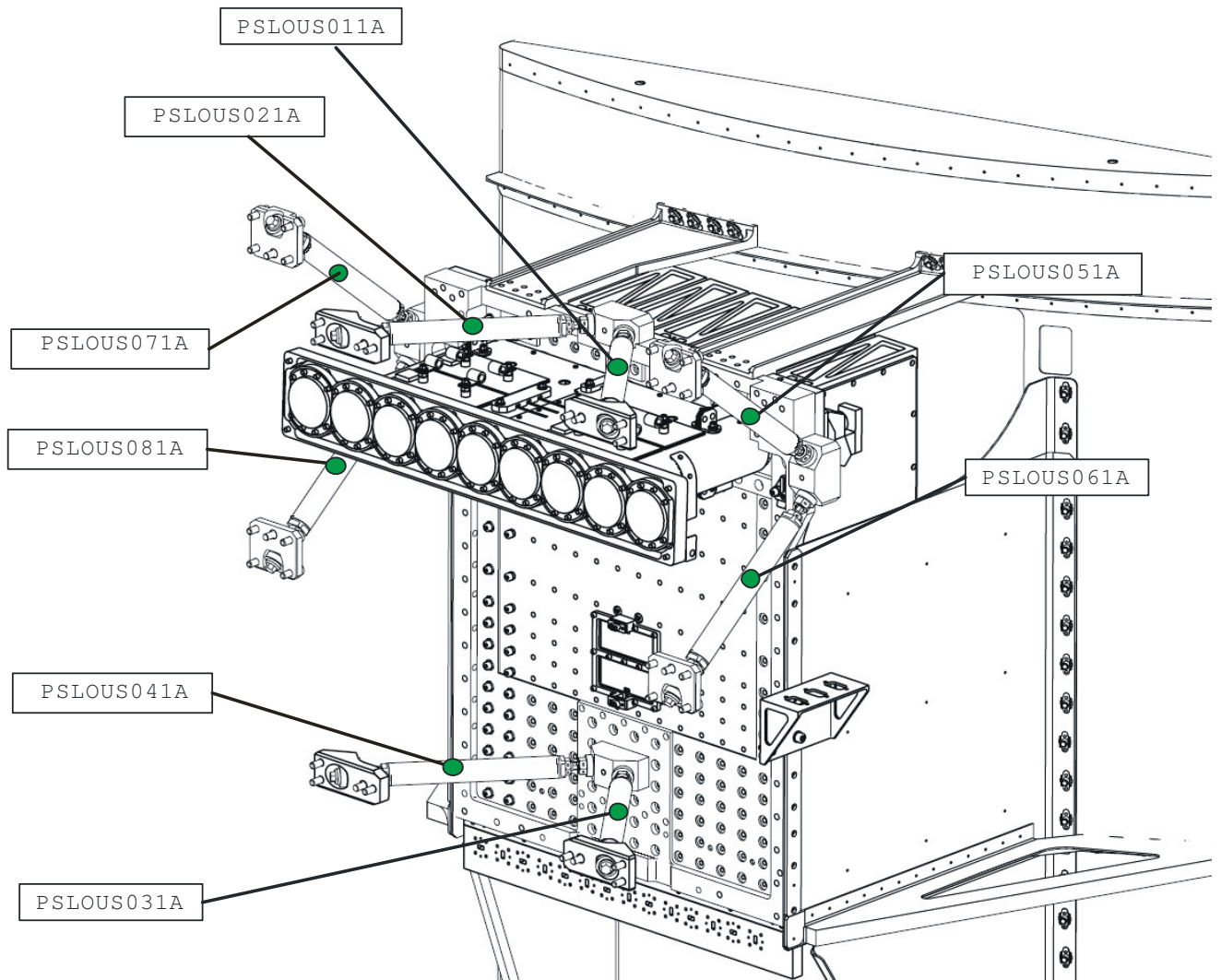

Figure 5-15: LOU Support Structure (shown with External LOU Baffle)

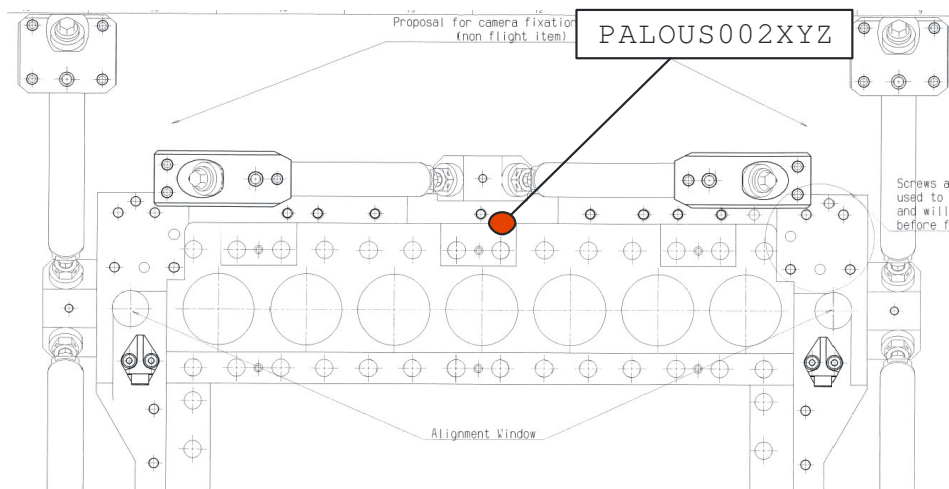

Figure 5-16: LOU Baffle I/F (baffle not shown)

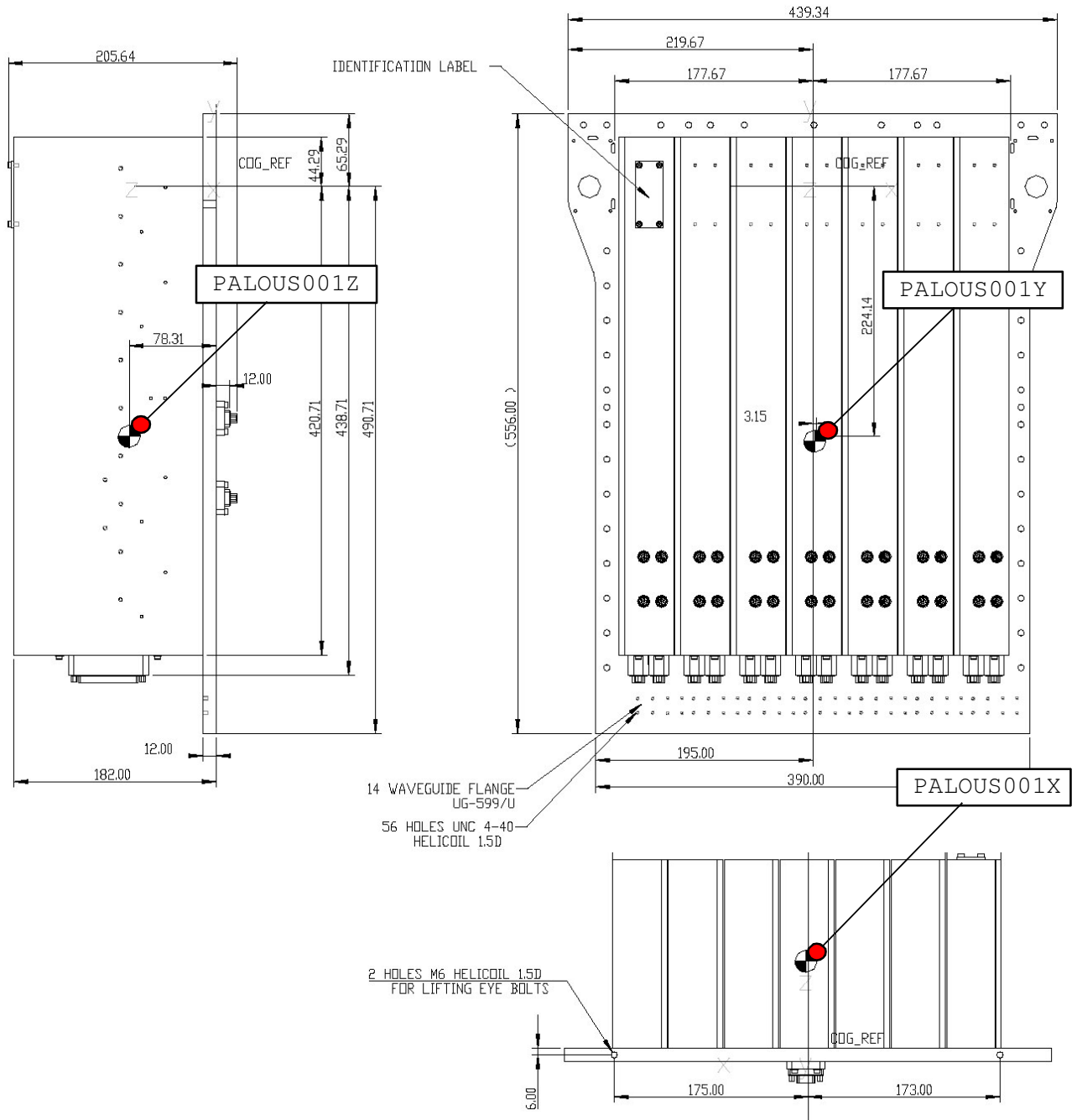

Figure 5-17: LOU sensors (shown here on MTD)

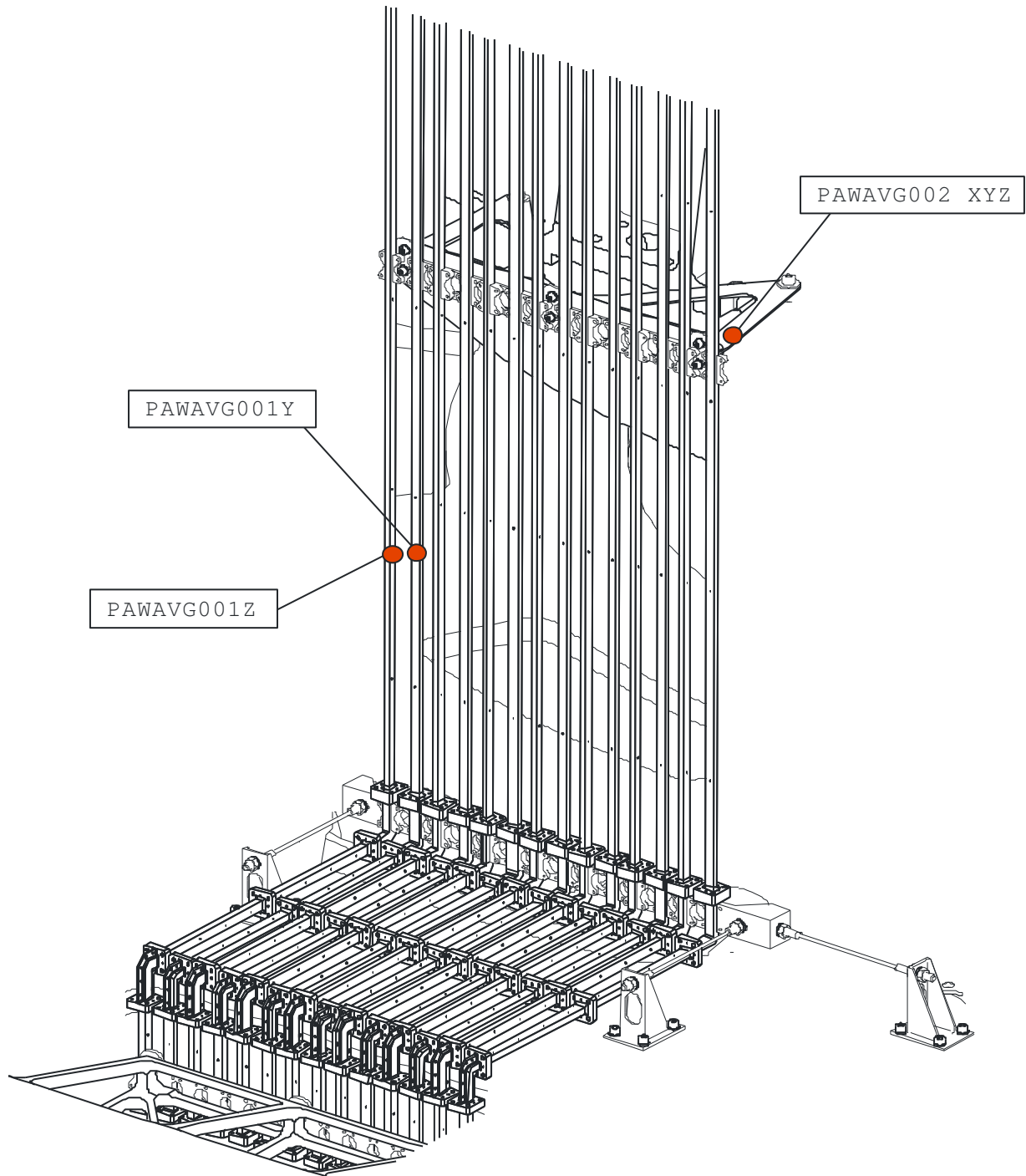

Figure 5-18: LOU Waveguides

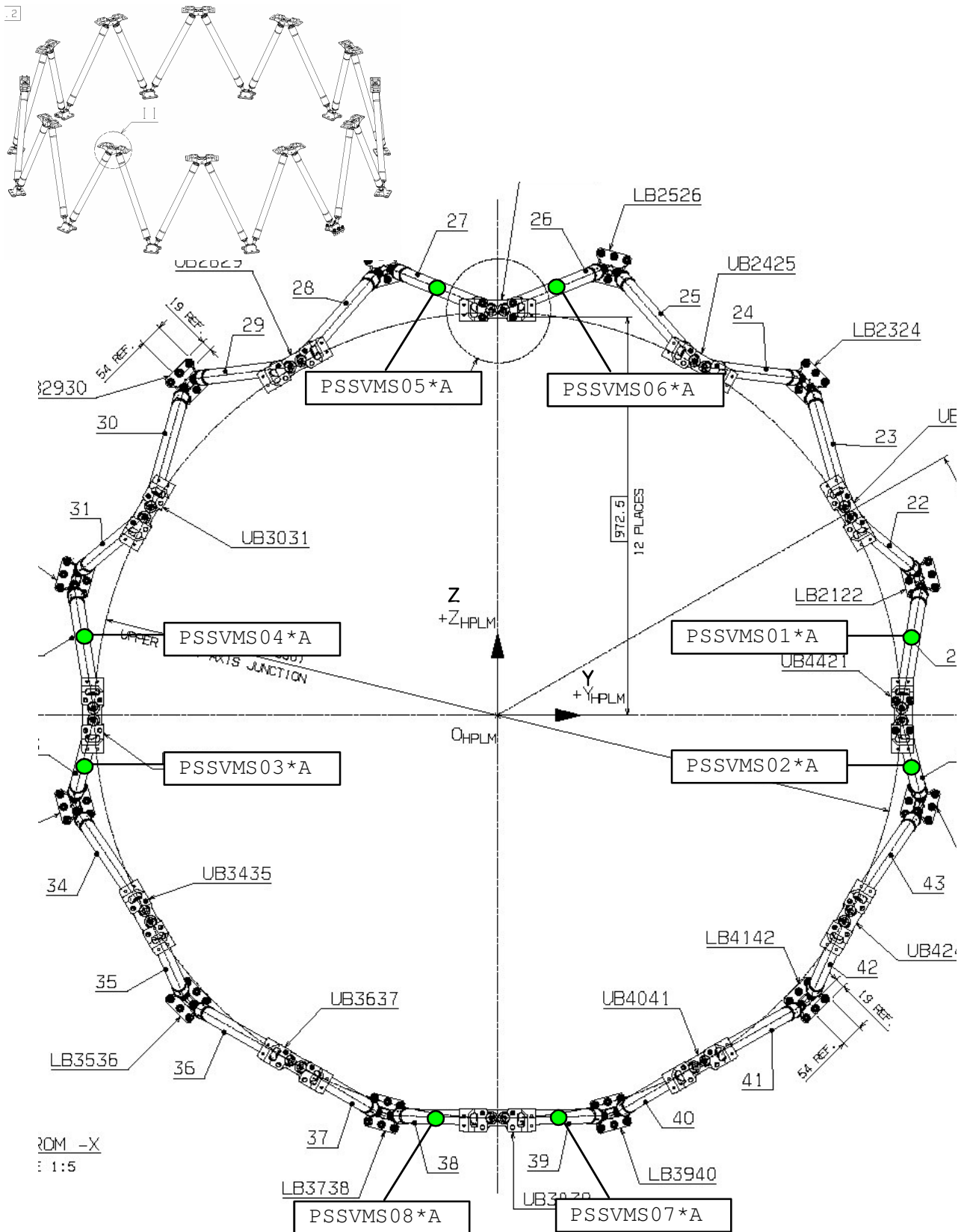

Figure 5-19: SVM/PLM Struts

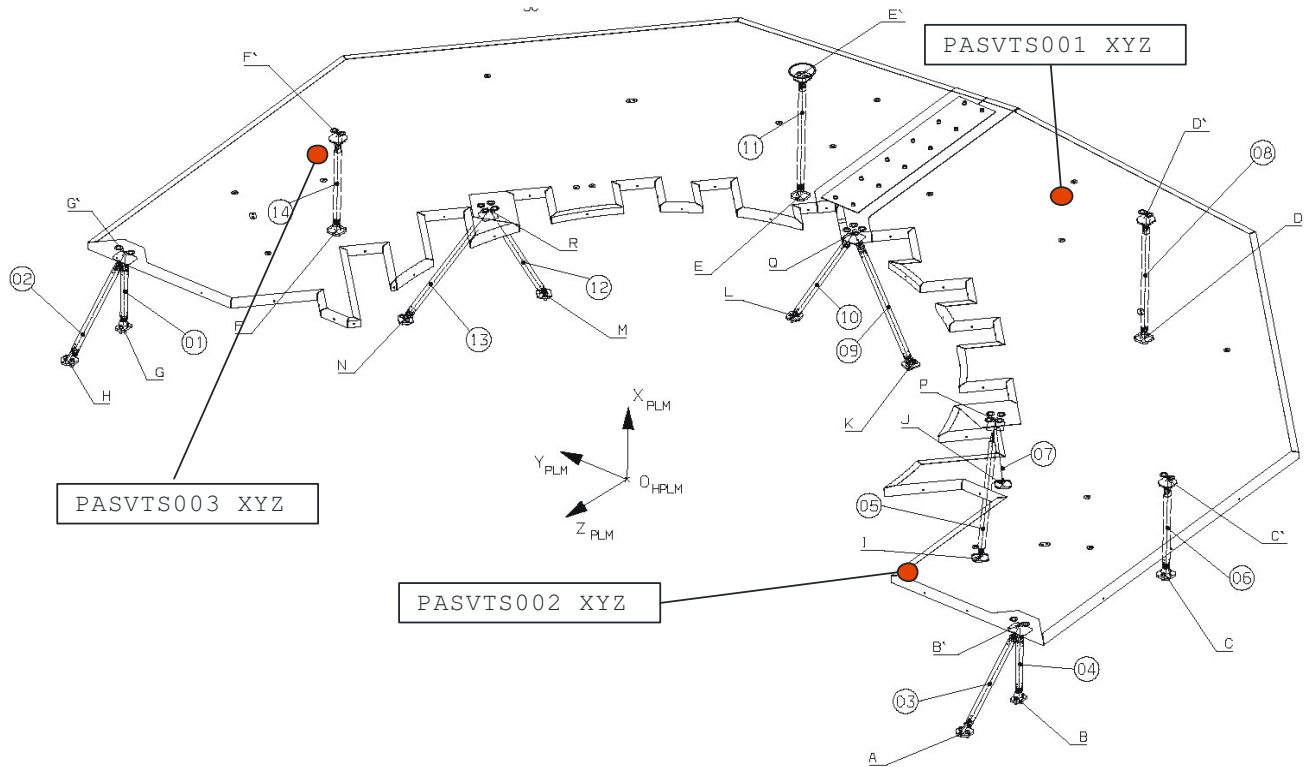

Figure 5-20: SVM Thermal Shield

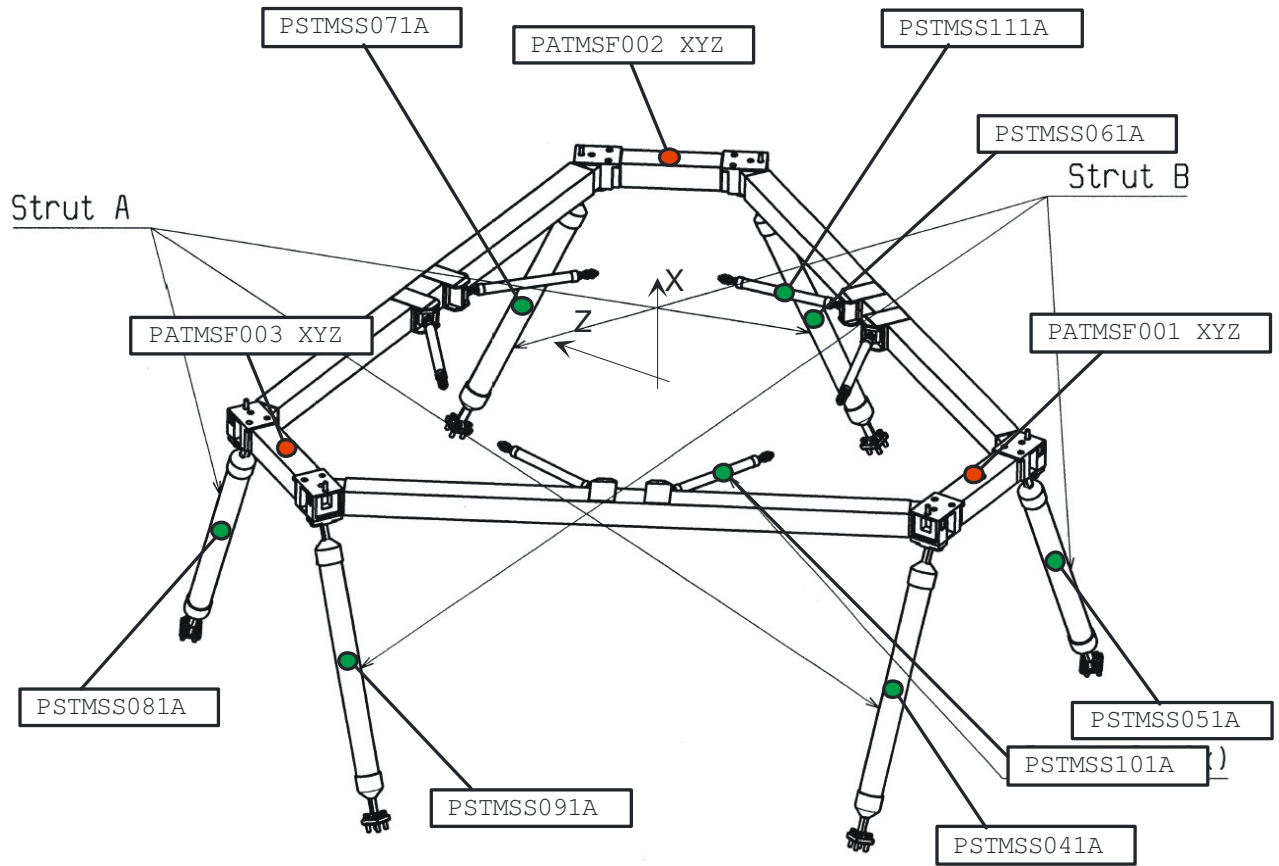

Figure 5-21: Telescope Mounting Structure, TMS

6 Annex B: Strain-gauge definitions

Lfn.	MP ID	Strut	Type	Location	Remark	DMS Type	Cable length sol list	Cable type	K-Factor	before the bond	after the bond	status	Date	Integrator
1	PSLOUS011A		strain gauge	LOU Strut, 0°/180°, T-rossette 0/90	full-bridge, bending compensated	CEA-06-125UT-350	3 10	4-dr. Teflon				open		
2	PSLOUS021A		strain gauge	LOU Strut, 0°/180°, T-rossette 0/90	full-bridge, bending compensated	CEA-06-125UT-350	3 10	4-dr. Teflon				open		
3	PSLOUS031A		strain gauge	LOU Strut, 0°/180°, T-rossette 0/90	full-bridge, bending compensated	CEA-06-125UT-350	3 10	4-dr. Teflon				open		
4	PSLOUS041A		strain gauge	LOU Strut, 0°/180°, T-rossette 0/90	full-bridge, bending compensated	CEA-06-125UT-350	3 10	4-dr. Teflon				open		
5	PSLOUS051A		strain gauge	LOU Strut, 0°/180°, T-rossette 0/90	full-bridge, bending compensated	CEA-06-125UT-350	3 10	4-dr. Teflon				open		
6	PSLOUS061A		strain gauge	LOU Strut, 0°/180°, T-rossette 0/90	full-bridge, bending compensated	CEA-06-125UT-350	3 10	4-dr. Teflon				open		
7	PSLOUS071A		strain gauge	LOU Strut, 0°/180°, T-rossette 0/90	full-bridge, bending compensated	CEA-06-125UT-350	3 10	4-dr. Teflon				open		
8	PSLOUS081A		strain gauge	LOU Strut, 0°/180°, T-rossette 0/90	full-bridge, bending compensated	CEA-06-125UT-350	3 10	4-dr. Teflon				open		
9	PSSA-S011A	01	strain gauge	Solar Array Strut 01, 0°, axial dir.	quarter-bridge	CEA-00-250UW-350	4.17 12	4-dr. Teflon	2.130			ok		
10	PSSA-S012A		strain gauge	Solar Array Strut 01, -120°, axial dir.	quarter-bridge	CEA-00-250UW-350	4.17 12	4-dr. Teflon	2.130			ok		
11	PSSA-S013A		strain gauge	Solar Array Strut 01, +120°, axial dir.	quarter-bridge	CEA-00-250UW-350	4.17 12	4-dr. Teflon	2.130			ok		
12	PSSA-S021A	02	strain gauge	Solar Array Strut 02, 0°, axial dir.	quarter-bridge	CEA-00-250UW-350	4 11	4-dr. Teflon	2.130			ok		
13	PSSA-S022A		strain gauge	Solar Array Strut 02, -120°, axial dir.	quarter-bridge	CEA-00-250UW-350	4 11	4-dr. Teflon	2.130			ok		
14	PSSA-S023A		strain gauge	Solar Array Strut 02, +120°, axial dir.	quarter-bridge	CEA-00-250UW-350	4 11	4-dr. Teflon	2.130			ok		
15	PSSA-S031A	03	strain gauge	Solar Array Strut 03, 0°, axial dir.	quarter-bridge	CEA-00-250UW-350	1.61 9	4-dr. Teflon	2.130			ok		
16	PSSA-S032A		strain gauge	Solar Array Strut 03, -120°, axial dir.	quarter-bridge	CEA-00-250UW-350	1.61 9	4-dr. Teflon	2.130			ok		
17	PSSA-S033A		strain gauge	Solar Array Strut 03, +120°, axial dir.	quarter-bridge	CEA-00-250UW-350	1.61 9	4-dr. Teflon	2.130			ok		
18	PSSA-S041A	04	strain gauge	Solar Array Strut 04, 0°, axial dir.	quarter-bridge	CEA-00-250UW-350	1.47 9	4-dr. Teflon	2.130			ok		
19	PSSA-S042A		strain gauge	Solar Array Strut 04, -120°, axial dir.	quarter-bridge	CEA-00-250UW-350	1.47 9	4-dr. Teflon	2.130			ok		
20	PSSA-S043A		strain gauge	Solar Array Strut 04, +120°, axial dir.	quarter-bridge	CEA-00-250UW-350	1.47 9	4-dr. Teflon	2.130			ok		
21	PSSA-S051A	05	strain gauge	Solar Array Strut 05, 0°, axial dir.	quarter-bridge	CEA-06-250UW-350	6.21 14	4-dr. Teflon	2.105	361 / 10.1	361 / 10.1	ok	10.08.2005	K.Thalheimer M.Wagner
22	PSSA-S052A		strain gauge	Solar Array Strut 05, -120°, axial dir.	quarter-bridge	CEA-06-250UW-350	6.21 14	4-dr. Teflon	2.105	361 / 10.0	361 / 10.1	ok	10.08.2005	K.Thalheimer M.Wagner
23	PSSA-S053A		strain gauge	Solar Array Strut 05, +120°, axial dir.	quarter-bridge	CEA-06-250UW-350	6.21 14	4-dr. Teflon	2.105	361 / 10.3	361 / 10.2	ok	10.08.2005	K.Thalheimer M.Wagner
24	PSSA-S061A	06	strain gauge	Solar Array Strut 06, 0°, axial dir.	quarter-bridge	CEA-06-250UW-350	6.32 14	4-dr. Teflon	2.105	361 / 10.1	361 / 10.0	ok	09.08.2005	K.Thalheimer M.Wagner
25	PSSA-S062A		strain gauge	Solar Array Strut 06, -120°, axial dir.	quarter-bridge	CEA-06-250UW-350	6.32 14	4-dr. Teflon	2.105	361 / 10.2	361 / 10.2	ok	09.08.2005	K.Thalheimer M.Wagner
26	PSSA-S063A		strain gauge	Solar Array Strut 06, +120°, axial dir.	quarter-bridge	CEA-06-250UW-350	6.32 14	4-dr. Teflon	2.105	361 / 10.4	361 / 10.4	ok	09.08.2005	K.Thalheimer M.Wagner
27	PSSA-S071A	07	strain gauge	Solar Array Strut 07, 0°, axial dir.	quarter-bridge	CEA-06-250UW-350	3.62 11	4-dr. Teflon	2.105	359 / 07.8	358 / 07.7	ok	08.08.2005	K.Thalheimer M.Wagner
28	PSSA-S072A		strain gauge	Solar Array Strut 07, -120°, axial dir.	quarter-bridge	CEA-06-250UW-350	3.62 11	4-dr. Teflon	2.105	359 / 08.0	358 / 08.5	ok	08.08.2005	K.Thalheimer M.Wagner
29	PSSA-S073A		strain gauge	Solar Array Strut 07, +120°, axial dir.	quarter-bridge	CEA-06-250UW-350	3.62 11	4-dr. Teflon	2.105	358 / 08.0	359 / 08.4	ok	08.08.2005	K.Thalheimer M.Wagner
30	PSSA-S081A	08	strain gauge	Solar Array Strut 08, 0°, axial dir.	quarter-bridge	CEA-06-250UW-350	3.52 11	4-dr. Teflon	2.105	359 / 08.2	359 / 08.3	ok	09.08.2005	K.Thalheimer M.Wagner
31	PSSA-S082A		strain gauge	Solar Array Strut 08, -120°, axial dir.	quarter-bridge	CEA-06-250UW-350	3.52 11	4-dr. Teflon	2.105	359 / 08.5	359 / 08.4	ok	09.08.2005	K.Thalheimer M.Wagner
32	PSSA-S083A		strain gauge	Solar Array Strut 08, +120°, axial dir.	quarter-bridge	CEA-06-250UW-350	3.52 11	4-dr. Teflon	2.105	359 / 08.5	359 / 08.3	ok	09.08.2005	K.Thalheimer M.Wagner
33	PSSA-S091A		strain gauge	Short Solar Array Strut SB1, 0°/180°, T-rossette 0/90	quarter-bridge	provided by DSSA	5 13	4-dr. Teflon	?					
34	PSSA-S101A		strain gauge	Short Solar Array Strut SB2, 0°/180°, T-rossette 0/90	quarter-bridge	provided by DSSA	2 11	4-dr. Teflon	?					
35	PSSA-S111A		strain gauge	Short Solar Array Strut SB3, 0°/180°, T-rossette 0/90	quarter-bridge	provided by DSSA	2 11	4-dr. Teflon	?					
36	PSSSDS091A	09	strain gauge	Sunshade Strut 09, 0°, axial dir.	quarter-bridge	CEA-06-250UW-350	7 14	4-dr. Teflon	2.105	361 / 10.2	361 - 7 / 10.1	soldering terminal is bonded	10.08.2005	K.Thalheimer M.Wagner
37	PSSSDS092A		strain gauge	Sunshade Strut 09, -120°, axial dir.	quarter-bridge	CEA-06-250UW-350	7 14	4-dr. Teflon	2.105	361 / 10.9	361 / 10.0	soldering terminal is bonded	10.08.2005	K.Thalheimer M.Wagner
38	PSSSDS093A		strain gauge	Sunshade Strut 09, +120°, axial dir.	quarter-bridge	CEA-06-250UW-350	7 14	4-dr. Teflon	2.105	361 / 10.0	360 / 09.8	soldering terminal is bonded	10.08.2005	K.Thalheimer M.Wagner
39	PSSSDS101A	10	strain gauge	Sunshade Strut 10, 0°, axial dir.	quarter-bridge	CEA-06-250UW-350	8.52 15.5	4-dr. Teflon	2.105	362 / 11.3		ok	11.08.2005	K.Thalheimer M.Wagner
40	PSSSDS102A		strain gauge	Sunshade Strut 10, -120°, axial dir.	quarter-bridge	CEA-06-250UW-350	8.52 15.5	4-dr. Teflon	2.105	363 / 11.4		ok	11.08.2005	K.Thalheimer M.Wagner
41	PSSSDS103A		strain gauge	Sunshade Strut 10, +120°, axial dir.	quarter-bridge	CEA-06-250UW-350	8.52 15.5	4-dr. Teflon	2.105	362 / 11.0		ok	11.08.2005	K.Thalheimer M.Wagner
42	PSSSDS111A	11	strain gauge	Sunshade Strut 11, 0°, axial dir.	quarter-bridge	CEA-06-250UW-350	5.82 13	4-dr. Teflon	2.105	361 / 09.0		ok	11.08.2005	K.Thalheimer M.Wagner
43	PSSSDS112A		strain gauge	Sunshade Strut 11, -120°, axial dir.	quarter-bridge	CEA-06-250UW-350	5.82 13	4-dr. Teflon	2.105	361 / 09.3		ok	11.08.2005	K.Thalheimer M.Wagner
44	PSSSDS113A		strain gauge	Sunshade Strut 11, +120°, axial dir.	quarter-bridge	CEA-06-250UW-350	5.82 13	4-dr. Teflon	2.105	361 / 09.4		ok	11.08.2005	K.Thalheimer M.Wagner
45	PSSSDS121A	12	strain gauge	Sunshade Strut 12, 0°, axial dir.	quarter-bridge	CEA-06-250UW-350	4.3 12	4-dr. Teflon	2.105	360 / 09.0		ok	11.08.2005	K.Thalheimer M.Wagner
46	PSSSDS122A		strain gauge	Sunshade Strut 12, -120°, axial dir.	quarter-bridge	CEA-06-250UW-350	4.3 12	4-dr. Teflon	2.105	360 / 09.1		ok	11.08.2005	K.Thalheimer M.Wagner
47	PSSSDS123A		strain gauge	Sunshade Strut 12, +120°, axial dir.	quarter-bridge	CEA-06-250UW-350	4.3 12	4-dr. Teflon	2.105	360 / 09.2		ok	11.08.2005	K.Thalheimer M.Wagner
48	PSSVMS011A	21	strain gauge	SVM Strut +Y, 0°, axial dir.	quarter-bridge	CEA-06-250UW-350	5.2 4.5	4-dr. Teflon	2.105			ok	29.07.2005	T.Mais M.Wagner
49	PSSVMS012A		strain gauge	SVM Strut -Y, -120°, axial dir.	quarter-bridge, contingency	CEA-06-250UW-350	5.2 4.5	4-dr. Teflon	2.105			ok	29.07.2005	T.Mais M.Wagner
50	PSSVMS013A		strain gauge	SVM Strut +Y, +120°, axial dir.	quarter-bridge, contingency	CEA-06-250UW-350	5.2 4.5	4-dr. Teflon	2.105			ok	29.07.2005	T.Mais M.Wagner
51	PSSVMS021A	44	strain gauge	SVM Strut +Y, 0°, axial dir.	quarter-bridge	CEA-06-250UW-350	4.3 3.5	4-dr. Teflon	2.105			ok	29.07.2005	T.Mais M.Wagner
52	PSSVMS022A		strain gauge	SVM Strut -Y, -120°, axial dir.	quarter-bridge, contingency	CEA-06-250UW-350	4.3 3.5	4-dr. Teflon	2.105			ok	29.07.2005	T.Mais M.Wagner
53	PSSVMS023A		strain gauge	SVM Strut +Y, +120°, axial dir.	quarter-bridge, contingency	CEA-06-250UW-350	4.3 3.5	4-dr. Teflon	2.105			ok	29.07.2005	T.Mais M.Wagner
54	PSSVMS031A	33	strain gauge	SVM Strut -Y, 0°, axial dir.	quarter-bridge	CEA-06-250UW-350	1.0 0.8	4-dr. Teflon	2.105			5° contorted	22.07.2005	T.Mais M.Wagner
55	PSSVMS032A		strain gauge	SVM Strut -Y, -120°, axial dir.	quarter-bridge, contingency	CEA-06-250UW-350	1.0 0.8	4-dr. Teflon	2.105			DMS zu bonded	22.07.2005	T.Mais M.Wagner
56	PSSVMS033A		strain gauge	SVM Strut -Y, +120°, axial dir.	quarter-bridge, contingency	CEA-06-250UW-350	1.0 0.8	4-dr. Teflon	2.105			ok	22.07.2005	T.Mais M.Wagner
57	PSSVMS041A	32	strain gauge	SVM Strut -Y, 0°, axial dir.	quarter-bridge	CEA-06-250UW-350	1.5 1.2	4-dr. Teflon	2.105			ok	22.07.2005	T.Mais M.Wagner
58	PSSVMS042A		strain gauge	SVM Strut -Y, -120°, axial dir.	quarter-bridge, contingency	CEA-06-250UW-350	1.5 1.2	4-dr. Teflon	2.105			ok	22.07.2005	T.Mais M.Wagner
59	PSSVMS043A		strain gauge	SVM Strut -Y, +120°, axial dir.	quarter-bridge, contingency	CEA-06-250UW-350	1.5 1.2	4-dr. Teflon	2.105			ok	22.07.2005	T.Mais M.Wagner
60	PSSVMS051A	27	strain gauge	SVM Strut +Z, 0°, axial dir.	quarter-bridge	CEA-06-250UW-350	2.9 2.0	4-dr. Teflon	2.105			ok	28.07.2005	T.Mais M.Wagner
61	PSSVMS052A		strain gauge	SVM Strut +Z, -120°, axial dir.	quarter-bridge, contingency	CEA-06-250UW-350	2.9 2.0	4-dr. Teflon	2.105			ok	28.07.2005	T.Mais M.Wagner
62	PSSVMS053A		strain gauge	SVM Strut +Z, +120°, axial dir.	quarter-bridge, contingency	CEA-06-250UW-350	2.9 2.0	4-dr. Teflon	2.105			ok	28.07.2005	T.Mais M.Wagner
63	PSSVMS061A	26	strain gauge	SVM Strut +Z, 0°, axial dir.	quarter-bridge	CEA-06-250UW-350	3.5 3.0	4-dr. Teflon	2.105			ok	28.07.2005	T.Mais M.Wagner
64	PSSVMS062A		strain gauge	SVM Strut +Z, -120°, axial dir.	quarter-bridge, contingency	CEA-06-250UW-350	3.5 3.0	4-dr. Teflon	2.105			ok	28.08.2005	T.Mais M.Wagner
65	PSSVMS063A		strain gauge	SVM Strut +Z, +120°, axial dir.	quarter-bridge, contingency	CEA-06-250UW-350	3.5 3.0	4-dr. Teflon	2.105			ok	28.08.2005	T.Mais M.Wagner
66	PSSVMS071A	39	strain gauge	SVM Strut -Z, 0°, axial dir.	quarter-bridge	CEA-06-250UW-350	2.7 3.5	4-dr. Teflon	2.105			ok	25.07.2005	T.Mais M.Wagner
67	PSSVMS072A		strain gauge	SVM Strut -Z, -120°, axial dir.	quarter-bridge, contingency	CEA-06-250UW-350	2.7 3.5	4-dr. Teflon	2.105			ok	25.07.2005	T.Mais M.Wagner
68	PSSVMS073A		strain gauge	SVM Strut -Z, +120°, axial dir.	quarter-bridge, contingency	CEA-06-250UW-350	2.7 3.5	4-dr. Teflon	2.105			ok	25.07.2005	T.Mais M.Wagner
69	PSSVMS081A	38	strain gauge	SVM Strut -Z, 0°, axial dir.	quarter-bridge	CEA-06-250UW-350	2.1 2.6	4-dr. Teflon	2.105			ok	25.07.2005	T.Mais M.Wagner
70	PSSVMS082A		strain gauge	SVM Strut -Z, -120°, axial dir.	quarter-bridge, contingency	CEA-06-250UW-350	2.1 2.6	4-dr. Teflon	2.105			ok		

END OF DOCUMENT

	Name	Dep./Comp.		Name	Dep./Comp.
X	Alberti von Mathias Dr.	ASG22	X	Schweickert Gunn	ASG22
	Baldock Richard	FAE12		Sonn Nico	ASG51
X	Barlage Bernhard	AED13		Steininger Eric	AED32
X	Bayer Thomas	ASA42	X	Stritter Rene	AED11
	Brune Holger	ASA45		Suess Rudi	OTN/ASA44
	Edelhoff Dirk	AED2		Wagner Klaus	ASG22
	Fehringer Alexander	ASG13	X	Wietbrock Walter	AET12
X	Fricke Wolfgang Dr.	AED 65	X	Wöhler Hans	ASG22
	Geiger Hermann	ASA42		Wössner Ulrich	ASE252
	Grasl Andreas	OTN/ASA44			
	Grasshoff Brigitte	AET12			
	Hamer Simon	Terma			
X	Hendry David	Terma			
	Hengstler Reinhold	ASA42			
	Hinger Jürgen	ASG22			
X	Hohn Rüdiger	AED65			
	Hölzle Edgar Dr.	AED32			
X	Huber Johann	ASA42			
	Hund Walter	ASE252			
	Idler Siegmund	AED312			
	Ivány von András	FAE12			
X	Jahn Gerd Dr.	ASG22			
	Kalde Clemens	ASM2			
	Kameter Rudolf	OTN/ASA42			
X	Kettner Bernhard	AET42			
	Knoblauch August	AET32	X	Alcatel Alenia Space Cannes	AAS-F
	Koelle Markus	ASA43	X	Alcatel Alenia Space Torino	AAS-I
	Koppe Axel	AED312	X	ESA/ESTEC	ESA
X	Kroeker Jürgen	AED65			
	La Gioia Valentina	Terma		Instruments:	
X	Lang Jürgen	ASE252	X	MPE (PACS)	MPE
X	Langenstein Rolf	AED15	X	RAL (SPIRE)	RAL
X	Langfermann Michael	ASA41	X	SRON (HIFI)	SRON
	Maukisch Jan	ASA43			
	Much Christoph	ASA43			
	Müller Jörg	ASA42		Subcontractors:	
	Müller Martin	ASA43		Alcatel Alenia Space Antwerp	ABSP
	Peltz Heinz-Willi	ASG13		Austrian Aerospace	AAE
	Pietroboni Karin	AED65		Austrian Aerospace	AAEM
	Platzer Wilhelm	AED2		BOC Edwards	BOCE
X	Reichle Konrad	ASA42		Dutch Space Solar Arrays	DSSA
X	Runge Axel	OTN/ASA44		EADS Astrium Sub-Subsyst. & Equipment	ASSE
	Schink Dietmar	AED32		EADS CASA Espacio	CASA
X	Schlosser Christian	OTN/ASA44		EADS CASA Espacio	ECAS
	Schmidt Rudolf	FAE12		European Test Services	ETS
	Schmidt Thomas	ASA42		Patria New Technologies Oy	PANT
	Schuler Günter	ASA42		SENER Ingenieria SA	SEN