



National Aeronautics and
Space Administration

SPIRE-REF-DOC-002340

**NOT MEASUREMENT
SENSITIVE**

**NASA-HDBK-7004A
NOVEMBER 5, 2002**

FORCE LIMITED VIBRATION TESTING

NASA TECHNICAL HANDBOOK

Approved for Public Release – Distribution is Unlimited

FOREWORD

This handbook is approved for use by NASA Headquarters and all Centers and is intended to provide a common framework for consistent practices across NASA programs. This first revision of the handbook includes force data measured in two flight experiments and a few minor editorial changes. The flight data provide validation of the force limiting methodology.

The primary goal of vibration tests of aerospace hardware is to identify problems that, if not remedied, would result in flight failures. This goal can only be met by implementing a realistic (flight-like) test with a specified positive margin. In most cases, the goal is not well served by traditional acceleration-controlled vibration tests that indeed screen out flight failures, but in addition may cause failures that would not occur in flight. The penalty of over testing is manifested in design and performance compromises, as well as in the high costs and schedule overruns associated with recovering from artificial test failures.

It has been known for 30 years that the major cause of over testing in aerospace vibration tests is associated with the infinite mechanical impedance of the shaker and the standard practice of controlling the input acceleration to the frequency envelope of the flight data. This approach results in artificially high shaker forces and responses at the resonance frequencies of the test item. To alleviate this problem it has become common practice to limit the acceleration responses in the test to those predicted for flight, but this approach is very dependent on the analysis that the test is supposed to validate. Another difficulty with response limiting is that it requires placing accelerometers on the test item at many critical locations, some of which are often inaccessible.

The advent of piezoelectric triaxial force gages has made possible an alternative, improved vibration-testing approach based on measuring and limiting the reaction force between the shaker and test item. Piezoelectric force gages are robust, relatively easy to install between the test item and shaker, and require the same signal conditioning as piezoelectric accelerometers commonly used in vibration testing. Also vibration test controllers now provide the capability to limit the measured forces and thereby notch the input acceleration in real time. To take advantage of this new capability to measure and control shaker force, a rationale for predicting the flight-limit forces has been developed, validated with flight measurements, and applied to many flight projects during the past five years. Force limited vibration tests are conducted routinely at the Jet Propulsion Laboratory (JPL) and also at several other NASA Centers, Government laboratories, and many aerospace contractors.

This handbook describes an approach that may be used to facilitate and maximize the benefits of applying this relatively new technology throughout NASA in a consistent manner. A NASA monograph, NASA-RP-1403, which provides more detailed information on the same subject, is also available for reference.

Requests for information, corrections, or additions to this handbook should be directed to the Mechanical Systems Engineering and Research Division, Section 352, Jet Propulsion Laboratory, 4800 Oak Grove Dr., Pasadena, CA 91109. Requests for general information concerning standards should be sent to NASA Technical Standards Program Office, ED41, MSFC, AL, 35812 (telephone 256-544-2448). This and other NASA standards may be viewed and downloaded, free-of-charge, from our NASA Standards Homepage:
<http://standards.nasa.gov/>

Original signed by:

Theron M. Bradley, Jr.
NASA Chief Engineer

TABLE OF CONTENTS

<u>PARAGRAPH</u>	<u>PAGE</u>
<u>FOREWORD</u>	i
<u>TABLE OF CONTENTS</u>	iii
<u>LIST OF FIGURES, TABLES, AND APPENDICES</u>	iv
1. <u>SCOPE</u>	1
1.1 Purpose	1
1.2 Applicability	1
2. <u>REFERENCE DOCUMENTS</u>	2
2.1 Government Documents	2
2.2 References	2
3. <u>DEFINITIONS</u>	3
4. <u>GENERAL REQUIREMENTS</u>	4
4.1 Criteria for Force Limiting.....	4
4.2 Instrumentation	5
4.2.1 Piezoelectric Force Gages	5
4.2.2 Force Gage Preload.....	5
4.2.3 Force Gage Calibration	5
4.2.4 Force Gage Combinations	6
4.2.5 Accelerometers	6
4.3 Fixtures	7
4.4 Force Specifications.....	7
4.4.1 Analytical Force Limits	7
4.4.2 Semi-Empirical Force Limits.....	8
4.4.3 Quasi-Static Design Verification.....	8
4.5 Control System	9
4.6 Test Planning Considerations	9
5. <u>DETAILED IMPLEMENTATION</u>	10
5.1 Derivation of Force Limits	10
5.1.1 Simple TDFS.....	10
5.1.2 Complex TDFS.....	10
5.1.3 Multiple Degree-of-Freedom Systems.....	13
5.1.4 Alternative Methods.....	13
5.2 Apparent and Effective Mass	14
5.2.1 Effective Mass Concept.....	14
5.2.2 Shaker Measurement of Payload Effective Mass	14
5.2.3 Tap Test Measurement of Source Effective Mass.....	14

TABLE OF CONTENTS (CONT'D)

<u>PARAGRAPH</u>	<u>PAGE</u>
6. <u>COMPARISON OF FLIGHT AND GROUND VIBRATION TEST DATA</u>	15
6.1 SVF-2 Experiment on Space Shuttle (STS-96)	15
6.2 CRIS Instrument on ACE Spacecraft	19
7. <u>NOTES</u>	23
7.1 Reduction of Mean-Square Response Due to Notching.....	23
7.2 Force Specification Example.....	23
7.3 Definition of Symbols	24

LIST OF FIGURES

<u>FIGURE</u>	<u>PAGE</u>
1. Simple TDFS of Coupled Oscillators	11
2. Normalized Force Spectrum for Simple TDFS	11
3. Complex TDFS with Residual and Modal Masses.....	13
4. SVF-2 Experiment on STS-96	15
5. Hitchhiker Canister for SVF-2	16
6. Force Limit in Vibration Test of SVF-2 Canister	17
7. Acceleration Input in Vibration Test of SVF-2 Canister	17
8. Y-Axis Acceleration at Top of SVF-2	18
9. Total Y-Axis Force in SVF-2 Flight.....	19
10. CRIS Instrument on ACE Spacecraft Bus.....	19
11. Total Vertical Force in CRIS Random Vibration Test	21
12. Notched Acceleration Input in CRIS Random Vibration Test	21
13. Spectral Density of In-Flight Normal Acceleration Measured Near One Mounting Foot of CRIS Instrument.....	22
14. Spectral Density of In-Flight Normal Force Measured Under CRIS Instrument.....	22
15. Reduction of SDFS Mean-Square Response by Notching	23

LIST OF TABLES

<u>TABLE</u>	<u>PAGE</u>
I. Normalized Force Spectrum for Complex TDFS with Q=20.....	12

APPENDICES

<u>APPENDIX</u>	<u>PAGE</u>
A Equations for Calculating the Simple TDFS Force Limits	25
B Calculation of Effective Mass	27
C Force Specification Example	29
Document History Log.....	30

FORCE LIMITED VIBRATION TESTING

1. SCOPE

1.1 Purpose. This handbook establishes a methodology for conducting force limited vibration tests for all NASA flight projects. The purpose is to provide an approach which may be consistently followed by those desiring to use force limiting, without having to conduct an extensive literature search or research and development effort before conducting the test. A monograph on Force Limited Vibration Testing is available for reference and is recommended for those needing more detailed technical information (NASA-RP-1403).

1.2 Applicability. This handbook recommends engineering practices for NASA programs and projects. It may be cited in contracts and program documents as a technical requirement or as a reference for guidance. Determining the suitability of this handbook and its provisions and providing for correct implementation is the responsibility of program/project management and the performing organization. Individual provisions of this handbook may be tailored (i.e., modified or deleted) by contract or program specifications to meet specific program/project needs and constraints.

For the purpose of this handbook, a force limited vibration test is any vibration test in which the force between the test item and shaker is measured and controlled. The recommended means of measuring the force is with piezoelectric force gages, but other means, e.g., shaker armature current or strain gages, may be useful in special situations. Similarly, the control of the force is preferably accomplished in real time, but iterative, off-line control may be employed as a stepping stone. If the force is not measured, the test is not considered a force limited vibration test, and this handbook does not apply. This distinction is important because in the past some have found it convenient to simulate a force limited test and then to use the analytical results to notch the acceleration input in the test. The simulation approach is not recommended because measurement of the force is considered to be the essential element of the force limiting approach.

This handbook is applicable to all force limited vibration tests of NASA flight hardware including aircraft and launch vehicle equipment, spacecraft and space experiment hardware.

Since the purpose of force limiting is to mitigate the effect of test item resonances in the vibration test, the technique is most useful for structure-like equipment and for fragile equipment such as optics and complex instruments. References 2, 5, 7, 10, and 13 provide examples of the use of force limiting in vibration tests of space flight hardware.

2. REFERENCE DOCUMENTS

2.1 Government documents.

- NASA-HDBK 7005 - Handbook for Dynamic Environmental Criteria, Final Draft #2. May 2000
- NASA-RP-1403 - Force Limited Vibration Testing Monograph, May 1997
- NASA-STD-7001 - Payload Vibroacoustic Test Criteria, June 21, 1996
- NASA-STD-7002 - Payload Test Requirements, July 10, 1996

2.2 References:

1. Blake R. E., "The Need to Control the Output Impedance of Vibration and Shock Machines," Shock and Vibration and Associated Environments, Bulletin No. 23, 1954.
2. Chang, K. Y. and Scharon, T. D., "Verification of Force and Acceleration Specifications for Random Vibration Tests of Cassini Spacecraft Equipment," ESA/CNES Conference on Spacecraft Structures, Materials, and Mechanical Testing, Noordwijk, NL, March 27-29, 1996.
3. Murfin, W. B., "Dual Specifications in Vibration Testing," Shock and Vibration Bulletin, No. 38, Part 1, 1968, pp. 109-113.
4. Salter, J. P., "Taming the General-Purpose Vibration Test," Shock and Vibration and Associated Environments, Bulletin No. 33, Part III, 1964, pp. 211-217.
5. Scharon, T. D., Boatman, D. J., and Kern, D. L., "Dual Control Vibration Testing," Proceedings of 60th Shock and Vibration Symposium, Vol. IV, 1989, pp. 199-217.
6. Scharon, T. D., "Analysis of Dual Control Vibration Testing," Proceedings of Institute of Environmental Sciences 36th Annual Technical Meeting, 1990, pp. 140-146.
7. Scharon, T. D., "Force Limited Vibration Testing at JPL," Proceedings of the Institute of Environmental Sciences 14th Aerospace Testing Seminar, 1993, pp. 241-251.
8. Scharon, T. D., "Vibration-Test Force Limits Derived from Frequency-Shift Method," AIAA Journal of Spacecraft and Rockets, Vol. 2, No. 2, March 1995, pp. 312-316.
9. Scharon, T., Bamford, R., and Hendrickson, J., "Force Limiting Research and Development at JPL," Spacecraft and Launch Vehicle Technical Information Meeting, Aerospace Corp., Los Angeles, CA, June 7, 1995.

10. Scharton, T. D., "In-flight Measurements of Dynamic Force and Comparison with the Specifications Used for Limiting the Forces in Ground Vibration Tests," European Conference on Spacecraft, Structures, Materials, and Mechanical Testing, Braunschweig, GR, November 1998.

11. Smallwood, D. O., "An Analytical Study of a Vibration Test Method Using Extremal Control of Acceleration and Force," Proceedings of Institute of Environmental Sciences 35th Annual Technical Meeting, 1989, pp. 263-271.

12. Smallwood, D. O., "Development of the Force Envelope for an Acceleration/Force Extremal Controlled Vibration Test," Proceedings of 61st Shock and Vibration Symposium, Vol. I, 1990, pp. 95-104.

13. Scharton, T. D., "Force Limits Measured on a Space Shuttle Flight", Proceedings of the 47th Annual Technical Meeting of the Institute of Environmental Sciences and Technology, ESTECH 2001, April 22, 2001.

14. Talapatra, D. C., McDonnell, R.H., and Hershfeld, D.J., "Analysis of STS-3 Get Away Special (GAS) Flight Data and Vibration Specifications for GAS Payloads", NASA Goddard Space Flight Center, Report 614-1, February 1983.

15. Wada, B. K., Bamford, R., and Garba, J. A., "Equivalent Spring-Mass System: A Physical Interpretation," Shock and Vibration Bulletin, No. 42, 1972, pp. 215-225.

3. DEFINITIONS

Accelerance	Complex frequency response function which is ratio of acceleration to force.
Acceleration of Center of Gravity (CG)	Acceleration of instantaneous centroid of distributed masses (equal to external force divided by total mass, according to Newton's 2nd Law).
Apparent Mass	Complex frequency response function which is ratio of force to acceleration.
Control System	The hardware and software that provide means for the test operator to translate vibration specifications into the drive signal for the shaker.
Design Verification Test	Test to see if as-built test item can survive design loads.
Dual Control	Control of both force and acceleration.
Dynamic Absorber	Single degree-of-freedom system (SDFS) tuned to excitation frequency to provide reaction force which reduces motion at attachment point.
Effective Mass	Masses in model consisting of SDFS's connected in parallel to a common base, so as to represent the apparent mass of a base-driven continuous system. The sum of the effective modal masses equals the total mass.
Extremal Control	A shaker controller algorithm based on control of the maximum (extreme) of a number of inputs in each frequency control band.

Flight Limits	Definition of accelerations or forces that are believed to be equal to the maximum flight environment, often P(95/50).
Force Limiting	Reduction of the reaction forces in a vibration test to specified values, usually to the interface forces predicted for flight, plus a desired margin.
Impedance	Complex frequency response function which is ratio of force to velocity quantities. (Sometimes used to refer to ratio of force to any motion quantity.)
Level	Test input or response in decibels (dB), $dB = 20 \log \text{amplitude} = 10 \log \text{power}$.
Margin	Factor to be multiplied times, or decibels to be added to, the flight limits to obtain the test specification.
Notching	Reduction of acceleration input spectrum in narrow frequency bands, usually where test item has resonances.
Payload	Vibration test item.
Quality Factor	The amplification (Q) of a SDFS at resonance, equal to the reciprocal of twice the critical damping ratio.
Quasi-Static Acceleration	Combination of static and low frequency loads into an equivalent load specified for design purposes as the CG acceleration.
Residual Mass	Sum of the effective masses of all modes with resonance frequencies greater than the excitation frequency.
Response Limiting	Reduction of input acceleration to maintain measured response at or below specified value.
Shaker	The machine that provides vibratory motion to the test item, usually electrodynamic in aerospace testing (can also be hydraulic or rotary).
Single Degree-of-Freedom System (SDFS)	Vibration model with one mass attached to a base with a spring.
Source	Test item support structure that provides in-flight vibration excitation.
Tap Test	Measurement of apparent mass or accelerance by tapping on structure with small rubber or plastic-tipped hammer that incorporates force transducer.
Test Fixture	Adapter hardware that allows test item to be mounted to shaker.
Three Axis Load Cell	Force gage which measures the three perpendicular components of force simultaneously.
Two Degree-Of-Freedom System (TDFS)	Vibration model with two masses attached to a base with springs.

4. GENERAL REQUIREMENTS

4.1 Criteria for Force Limiting. The purpose of force limiting is to reduce the response of the test item at its resonances on the shaker in order to replicate the response at the combined system resonances in the flight-mounting configuration. References 1, 3, and 6 provide background information and rationale on the need for force limiting in vibration tests. Force limiting is most useful for structure-like test items that exhibit distinct, lightly damped resonances on the shaker. Examples are: complete spacecraft, cantilevered structures like telescopes and

antennas, lightly damped assemblies such as cold stages, fragile optical components, and equipment with pronounced fundamental modes such as a rigid structure with flexible feet. The amount of relief available from force limiting is greatest when the structural impedance (effective mass) of the test item is equal to, or greater than, that of the mounting structure. However, it is recommended that notches deeper than 14 dB be implemented only with appropriate peer review. Force limiting is most beneficial when the penalties of an artificial test failure are high. Sometimes this is after an initial test failure.

4.2 Instrumentation.

4.2.1 Piezoelectric Force Gages. The use of piezoelectric force gages for force limiting is highly recommended over other types of force measurement means, such as strain gages, armature current, etc. The advent of piezoelectric, quartz force gages has made the measurement of force in vibration tests almost as convenient and accurate as the measurement of acceleration. The high degree of linearity, dynamic range, rigidity, and stability of quartz make it an excellent transducer material for both accelerometers and force gages. Similar signal processing, charge amplifiers and voltage amplifiers, may be used for piezoelectric force gages and accelerometers. However, there are several important differences between these two types of measurement. Force gages must be inserted between (in series with) the test item and shaker and therefore require special fasteners, whereas accelerometers are placed upon (in parallel with) the test item or shaker. The total force into the test item from several gages placed at each shaker attachment may be obtained by simply using a junction to add the charges before they are converted to voltage, whereas the output of several accelerometers is typically averaged after the charge is converted to voltage. Finally, piezoelectric force gages tend to put out more charge than piezoelectric accelerometers because the force gage crystals experience higher loading forces, so sometimes it is necessary to use a charge attenuator before the charge amplifier.

4.2.2 Force Gage Preload. Piezoelectric force gages must be preloaded so that the transducer always operates in compression. This preload is achieved using a threaded bolt or stud, which passes through the inside diameter of the transducer. The static compression force in the transducer is balanced by the static tension in the bolt. Having a high preload and a smooth transducer and mating surfaces minimizes several common types of measurement errors, e.g., bending moments being falsely sensed as tension/compression. However, using flight hardware and fasteners, it is usually impossible to achieve the force gage manufacturer's recommended preload. In addition, sometimes it is necessary to tradeoff transducer preload and dynamic load carrying capability, particularly for moments. The three requirements for selecting the preload are: (1) that the preload is sufficient to prevent unloading due to the dynamic forces and moments, e.g., heel-to-toe rocking; (2) that the maximum stress on the transducers does not exceed that associated with the maximum load set specified by the manufacturer; and (3) that the preload is sufficient to carry the shear loads via friction, without slip.

When the bolt preload is critical, which is often the case for large test items like spacecraft, the force transducers may be used to measure the bolt preload while the bolts are torqued. (The actual preload resulting from a specified value of torque may vary by a factor of two or more, depending on friction and lubrication.) Piezoelectric force transducers are dynamic, not static sensors. However, when charge amplifiers with high input resistance and a long time constant option are utilized, the preload force values for each gage may be held steady for hours, which is ample time for the bolt torquing sequence.

4.2.3 Force Gage Calibration. The force gage manufacturer provides a nominal calibration for each transducer, but the sensitivity of installed units must generally be determined insitu, because the preload bolt carries a portion of the dynamic load. (Some transducer manufacturers offer standard preload hardware, but for aerospace applications the preload configuration is usually tailored to the installation; often a flight-like bolt is used.) The transducer and the bolt act like two springs in parallel, and the fluctuating load carried by each is proportional to their stiffness. Therefore the sensitivity of the transducer is reduced by the ratio of the transducer stiffness to the sum of the bolt plus the transducer stiffness. (The flexibility of any structural elements, mounting feet, etc., in these two load paths must also be included.) The transducer stiffness is available from the manufacturer and the stiffness of the bolt and structural elements can be estimated from strength-of-materials or finite-element-model (FEM) calculations.

Insitu calibration of force gages may be accomplished either statically or dynamically. The recommended method of calibrating the transducers for a force limited vibration test is to conduct a preliminary low-level sine-sweep or random run. The low frequency asymptote of the apparent mass is compared with the known total mass of the test item. (The relevant apparent mass is the ratio of total force to the input acceleration in the shake direction.) If it is not possible to start the sweep at a frequency sufficiently below the first resonance of the test item, it may be necessary to use the single degree-of-freedom system (SDFS) transmissibility to determine a correction (amplification) factor for the low frequency asymptote. Typically, the force measured before correcting for the preload bolt will be approximately 80 to 90 percent of the test item total weight in the axial direction and 90 to 95 percent of the total weight in the lateral directions.

Alternately, using the charge amplifier configuration discussed in Section 4.2.2 for measuring preload, the transducer installation may be calibrated statically using weights, springs, or hydraulic loads. It is recommended that a static calibration be performed by first loading the transducers, zeroing out the charge, and then removing the load, in order to minimize any transient overshoot associated with the load application.

4.2.4 Force Gage Combinations. It is recommended that the total force in the shaker excitation direction be measured in a force limited vibration test. The total force from a number of gages in parallel is readily obtained using a junction box that sums the charges, and therefore the forces, before conditioning the signal with a charge amplifier. An alternative is to specify limits for the force at individual attachment positions, but this is not recommended. Since vibration tests are normally conducted sequentially in three perpendicular axes, it is convenient to employ triaxial force transducers. Sometimes it is necessary to limit the cross-axis force and the moments in addition to the in-axis force; this is particularly the case in tests of large eccentric test items such as spacecraft. For these applications, the six force resultant forces and moments for a single node may be measured with a combination, commonly four, of triaxial force transducers and a special voltage summing amplifier, which is generally available from the force gage manufacturers.

4.2.5 Accelerometers. Accelerometers on the fixture are also required in force limited vibration tests in order to control the acceleration input to the acceleration specification at frequencies other than at the test item resonances. In addition, it is often convenient to use a limited number of accelerometers to measure the response at critical positions on the test item. These response accelerometers may be used only for monitoring or if justified by appropriate rationale, for response limiting in addition to the force limiting.

4.3 Fixtures. The preferred method of configuring the force gages is to sandwich one gage between the test item and conventional test fixture at each attachment position and use fasteners that are longer than the conventional ones to accommodate the thickness of the gages. In this configuration, there is no fixture weight above the transducers and the gage force is identical to the force into the test item. Sometimes the preferred approach is impractical; e.g., if there are too many attachment points or the attachments involve shear pins in addition to bolts. In these cases it may be necessary to use one or more adapter plates to interface the transducers to the test item. The requirement is that the total weight of the adapter plates above the force gages does not exceed 10 percent of the weight of the test item. This limitation is necessary because the force gages read the sum of the force required to accelerate the interface plate and that delivered to the test item. If the fixture weight exceeds the 10 percent criterion, force limiting will only be useful for the first one or two modes in each axis. Use of a circuit to subtract the interface plate force in real time is not recommended because of the phase errors that result when the interface plate is not rigid. The use of armature current to measure shaker force is also not recommended, because the weight of the armature and fixtures typically are much greater than 10 percent of that of the test item and also because of phase errors associated with electromechanical resonances.

4.4 Force Specifications. Force limits are analogous and complementary to the acceleration specifications used in conventional vibration testing. Just as the acceleration specification is the frequency spectrum envelope of the in-flight acceleration at the interface between the test item and flight mounting structure, the force limit is the envelope of the in-flight force at the interface. In force limited vibration tests, both the acceleration and force specifications are needed, and the force specification is generally based on and proportional to the acceleration specification. Therefore, force limiting does not compensate for errors in the development of the acceleration specification, e.g., too much conservatism or the lack thereof. These errors will carry over into the force specification. Since in-flight vibratory force data are scarce, force limits are often derived from coupled system analyses and impedance information obtained from measurements or finite element models (FEM). Fortunately, data on the interface forces between systems and components are now available from system acoustic and vibration tests of development test models and from a few flight experiments. Semi-empirical methods of predicting force limits are currently being developed on the basis of the limited flight and system test data.

4.4.1 Analytical Force Limits. Analytical models and methods of obtaining impedance information to use in these models are discussed in Section 5.0. Here, the general requirements for analytically deriving force limits are discussed. It is required that analytical models used to predict force limits take into account the resonant behavior of both the source (mounting structure) and the payload (test item) and that the models incorporate impedance information, from test data or finite element models (FEM's), on both the source and the payload. The models discussed in 5.0 are two degree-of-freedom system (TDFS) models, in which the coupled source and payload are each described by a single resonant mode. In more complex models, the source and payload may have many modes. In the early stages of a program, before hardware exists, strength of materials or FEM's are often used to determine the modal parameters of the source and payload. Later in the program, before the vibration tests of flight hardware, it is recommended that the modal parameters be updated with impedance data measured in tap tests on the mounting structure and in the shaker tests of the test item. The coupled source and payload models are exercised with some representative excitation of the source, and the envelope (or peak values) of the interface acceleration and

interface force frequency response functions (FRF) are calculated, preferably in one-third octave bands. The ratio of the interface force envelope to the acceleration envelope is calculated from the model. Finally, the force limit specification is calculated by multiplying the conventional acceleration specification by this ratio. (It is essential that the ratio of the envelopes or peaks, not of the actual FRF's, be calculated.) The simple and complex TDFS methods discussed in Section 5.1 and illustrated in Figures 1-3 are examples of this approach.

4.4.2 Semi-Empirical Force Limits. The alternative semi-empirical approach to deriving force limits is based on the extrapolation of interface force data for similar mounting structure and test items. A general form for a semi-empirical force limit for sine or transient tests follows from Reference 4.

$$F_s = C M_o A_s \quad , \quad f < f_o \quad (1a)$$

$$F_s = C M_o A_s (f_o/f) \quad , \quad f \geq f_o$$

where F_s is the amplitude of the force limit, C is a dimensionless constant which depends on the configuration, M_o is the total mass of the payload (test item), A_s is the amplitude of the acceleration specification, f is frequency, and f_o is the frequency of the primary mode, i.e. the mode with the greatest effective mass. The form of Equation (1a) appropriate for random vibration tests is:

$$S_{FF} = C^2 M_o^2 S_{AA} \quad , \quad f < f_o \quad (1b)$$

$$S_{FF} = C^2 M_o^2 S_{AA} (f_o/f)^2 \quad , \quad f \geq f_o$$

where S_{FF} is the force spectral density and S_{AA} is the acceleration spectral density. Comparing Equation (1b) with Figure 2, which is discussed in detail in Section 5.1.1, it may be apparent that C^2 is equivalent to the ordinate in Figure 2, and that the constant C replaces the quality factor Q of the isolated payload system. The factor (f_o/f) has been included in Equations (1a) and (1b) to reflect the decrease in the payload residual mass with frequency. Sometimes it is appropriate to adjust the exponent of this factor to fit experimental measurements of the apparent mass of the test item.

Section 6.1 of this report presents interface force data measured between a 65 lb (30kg) instrument (CRIS) and the Advanced Composition Explorer (ACE) spacecraft during the launch of an expendable launch vehicle. Section 6.2 of the report presents force data measured between a 230 lb (104 kg) sidewall-mounted payload (SVF) and the space shuttle (STS) during launch. The force data measured on the ACE spacecraft and on the space shuttle flights are both enveloped by Equation (1b) with C approximately equal to the square-root of two. However, in order to use the semi-empirical method to predict force limits for a new hardware configuration, it is required to show similarity between the new configuration and the reference data configuration. For new configurations with different ratios of payload to source masses, Figure 2 may be used to scale the value of the constant C .

4.4.3 Quasi-Static Design Verification. The design of aerospace components is often based on a prediction of the maximum acceleration of the center of gravity (CG) of the component expected in flight, i.e., the quasi-static limit load. However, the CG of a flexible body is a virtual (not

a real) point and its acceleration is very difficult to measure with an accelerometer in a vibration test, particularly at frequencies above the fundamental resonance. However, Newton's second law says that the external source equals the total mass times the CG acceleration. Thus, limiting the measured external force to the product of the total mass of the test item times the quasi-static load limit is the recommended method of limiting the CG acceleration in vibration tests. (Sometimes the limit load is multiplied by a factor of 1.2 or 1.25 for a design verification test.) This approach is valid at all frequencies. In addition, force gages may be used to control the applied forces or moments in a vibration test to the values derived from the coupled-loads analysis.

4.5 Control System. Most vibration test controllers have the two capabilities needed to automatically implement force limiting. (Force limiting is viewed as a form of response limiting by most of the controller manufacturers.) To implement force limiting, the controller must first be capable of "extremal control," sometimes called maximum or peak control by different vendors. In extremal control, the largest of a set of signals is limited to a single reference spectrum. Most controllers used in aerospace testing laboratories support extremal control. The second capability, which is highly desirable but not absolutely essential, is that the controller should accommodate different reference spectra for limiting individual response (and force) measurement channels. Controllers that support response limiting are available from most vendors, and in addition, upgrade packages are available to retrofit some of the older controllers for this capability.

If the controller has extremal-control capability, but not response-limiting capability, there are still two possibilities for automatic force limiting. First, the gain of the charge amplifier used to condition the force signal may be adjusted to achieve the desired amount of force limiting. The problem with this approach is that the force limit is then independent of frequency, and the limiting and notching is generally restricted to the fundamental mode, since the force associated with the higher order modes decreases with increasing frequency. A second more elaborate approach, used in the early days of force limiting, is to use a graphic equalizer type of filter to shape the frequency spectrum of the force signal.

If the controller does not have either the extremal-control or response-limiting capability, notching of the acceleration specification to limit the force to the force specification must be done manually based on the force measured in low-level runs.

4.6 Test Planning Considerations. Several considerations need to be addressed in the test planning phase of the program if force limiting is to be employed. First, the size, number, and availability of the force transducers need to be identified as well as any special fixture requirements to accommodate the transducers. Next, the approach for deriving and updating the force specification needs to be decided. Finally the control strategy, which in special cases may include cross-axis force, moment, individual force, and response limiting in addition to the in-axis force, must be decided and written into the test plan. In some instances, the control strategy will be limited by the control system capabilities. In all cases, it is recommended that the control strategy be kept as simple as possible, in order to expedite the test and to minimize the possibility of mistakes. In most cases, limiting the total in-axis force will suffice. If required, the rationale for force limiting should be discussed and concurrence obtained from the appropriate organizations, which may include the customer, Government overseer, quality control, etc.

5. DETAILED IMPLEMENTATION

5.1 Derivation of Force Limits. As the force limiting technology matures, there may eventually be as many methods of deriving force limits as there are of deriving acceleration specifications. Several acceptable methods are described herein.

Force spectra have typically been developed in one-third octave bands (see example in Section 6.2), but other bandwidths, e.g., octave or one-tenth octave bands, may also be used. Force limiting is usually restricted to the frequency regime encompassing approximately the first three modes in each axis; which might be approximately 100 Hz for a large spacecraft, 500 Hz for an instrument, or 2000 Hz for a small component. It is important to take into account that the test item resonances on the shaker occur at considerably higher frequencies than in flight. Therefore, care must be taken not to roll off the force specification at a frequency lower than the fundamental resonance on the shaker and not to roll off the specification too steeply; i.e., it is recommended that the roll-off of the force spectrum be limited to approximately 9 dB/octave.

5.1.1 Simple TDFS. The simple TDFS method of deriving force limits is described in Reference 8. The basic model is shown in Figure 1. The model represents one vibration mode of the source (system 1) coupled with one vibration mode of the payload (system 2). Figure 2 shows the ratio of the interface force spectral density S_{FF} to the interface acceleration spectral density S_{AA} , normalized by the payload mass M_2 squared, as a function of the mass ratio M_2/M_1 , calculated from the simple TDFS. When this mass ratio is very small, there is no force limiting effect; the force spectral density asymptote is the payload mass M_2 squared times the input acceleration spectral density times the quality factor Q_2 squared. The ratio of this asymptotic value of the force to the force limit at larger values of M_2/M_1 , is the expected amount of notching, sometimes called the knockdown factor. The force limit is insensitive to damping at values of M_2/M_1 greater than 0.4, but the peak value of the unnotched force spectrum, and therefore the notch depth resulting from force limiting, will be proportional to the actual quality factor Q_2 squared. To use Figure 2, the source and payload masses must be determined from FEM analyses or measurements as a function of frequency. It is recommended that one-third octave frequency bands be utilized. In the simple TDFS method, it is recommended for conservatism that these masses be taken as the residual masses rather than the modal masses. Appendix A gives the equations for replicating the curves in Figure 2.

Figure 2 is particularly useful for choosing the value of the constant C in the semi-empirical method described in Section 4.4.2. That the ordinate of Figure 2 corresponds to the constant C squared in the semi-empirical method may be seen by comparing Equations (1b) and (A2), with the residual mass of the payload m_2 in Equation (A2) equated to the factors M_0 (f/f_0) in Equation (1b). (Of course, Equation (A1) must be substituted into Equation (A2) to eliminate the frequency ratio term, as discussed in Appendix A.)

5.1.2 Complex TDFS. The complex TDFS method of deriving force limits is also described in Reference 8. The complex TDFS model is shown in Figure 3; it requires both the modal (m) and the residual (M) masses of the source and payload. Table I tabulates the normalized ratio of interface force spectral density to input acceleration spectral density for a complex TDFS with $Q=20$, which is a good nominal value for most practical applications. It is recommended that both the simple and complex TDFS models be used and that the larger of the two calculations be used in each one-third-octave frequency band. It will generally be found that the simple TDFS gives the larger result off the payload resonances and the complex TDFS

gives the larger result at the payload resonances. Notice that the normalized force in Table I is equal to unity for $m_2/M_2 = 0$, i.e. no payload modal mass, and should be interpolated for

$$0 < m_2/M_2 < 0.125.$$

Table I does not include results for ratios of the source modal to residual mass (m_1/M_1) less than 0.25, because it is felt that these cases represent local source modes, which may not be relevant to the interface environment. However, values for $m_1/M_1 < 0.25$ are tabulated in the monograph "Force Limited Vibration Testing," referenced in Section 2.1.

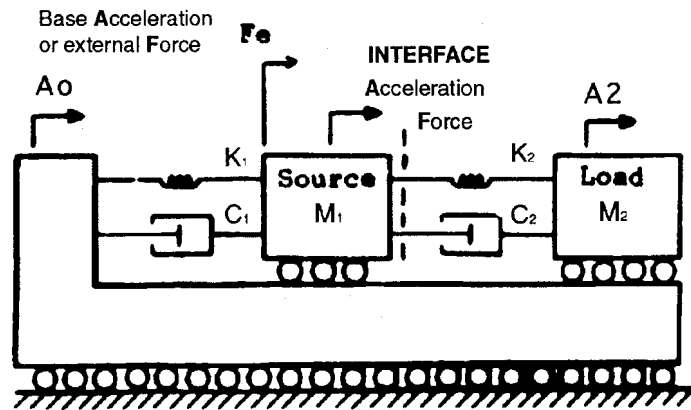

FIGURE 1. Simple Two-Degree-of-Freedom System (TDFS) of Coupled Oscillators

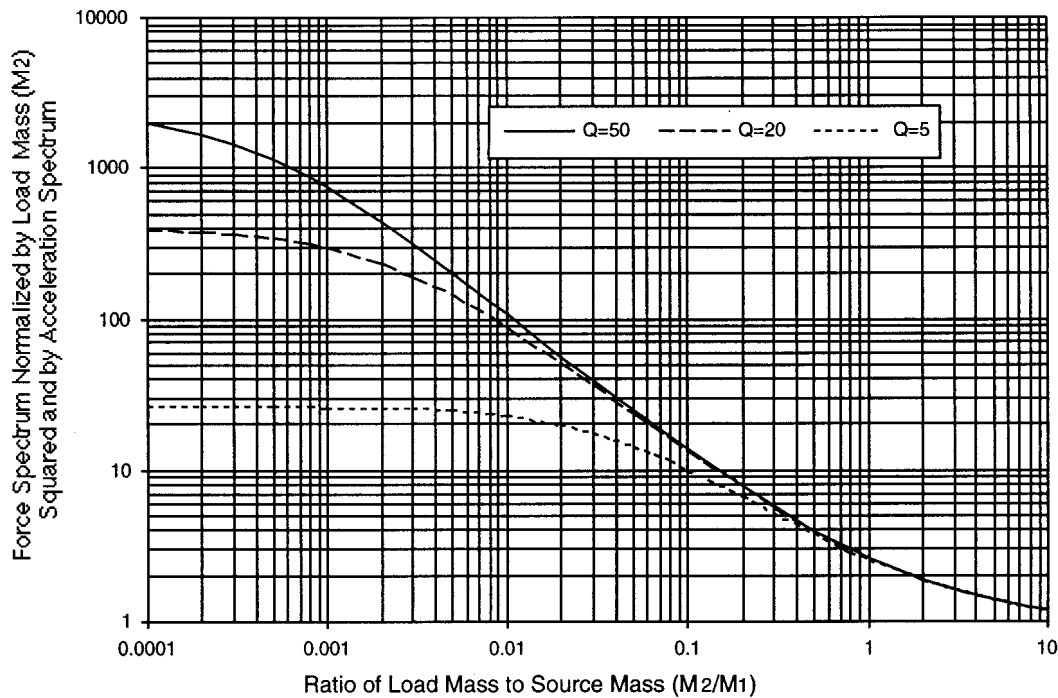

Figure 2. Normalized Force Specification from Simple TDFS

Table I. Normalized Force Spectrum for Complex TDFS with Q=20

Ratio of modal to residual mass m1/M1, m2/M2	Residual mass ratio, M2/M1								
	0.001	0.003	0.01	0.03	0.1	0.3	1	3	10
8.0, 8.0	932	933	936	948	1001	1180	1240	1234	1238
8.0, 4.0	233	233	233	235	239	256	294	265	250
8.0, 2.0	58	58	58	58	59	60	68	73	68
8.0, 1.0	15	15	15	15	15	15	17	23	22
8.0, 0.5	4	4	4	4	4	4	4	7	6
8.0, 0.25	1	1	1	1	1	1	1	2	5
8.0, 0.125	1	1	1	1	1	1	1	1	3
8.0, 0.0	1	1	1	1	1	1	1	1	1
4.0, 8.0	871	867	858	849	904	1042	1067	1110	1229
4.0, 4.0	218	218	217	216	220	250	254	250	252
4.0, 2.0	55	55	55	55	56	61	72	68	67
4.0, 1.0	14	14	14	14	14	16	21	23	22
4.0, 0.5	3	3	4	4	4	4	6	10	10
4.0, 0.25	1	1	1	1	1	1	2	5	5
4.0, 0.125	1	1	1	1	1	1	1	3	3
4.0, 0.0	1	1	1	1	1	1	1	1	1
2.0, 8.0	1586	1478	1260	1061	990	946	982	1099	1201
2.0, 4.0	406	391	355	305	272	259	238	236	254
2.0, 2.0	103	101	97	88	79	82	70	65	62
2.0, 1.0	26	26	26	25	24	25	25	23	22
2.0, 0.5	7	7	7	7	7	9	10	10	10
2.0, 0.25	2	2	2	2	2	3	5	5	6
2.0, 0.125	1	1	1	1	1	1	3	3	4
2.0, 0.0	1	1	1	1	1	1	1	1	1
1.0, 8.0	11041	5731	2714	1486	967	901	984	1095	1181
1.0, 4.0	3869	2206	1105	567	332	247	233	238	248
1.0, 2.0	1228	826	432	226	125	83	71	66	64
1.0, 1.0	359	283	166	100	50	34	26	23	23
1.0, 0.5	100	89	63	42	24	15	12	11	11
1.0, 0.25	28	27	23	17	11	8	6	6	6
1.0, 0.125	8	8	8	7	5	5	4	4	4
1.0, 0.0	1	1	1	1	1	1	1	1	1
0.5, 8.0	13889	7720	3501	1726	1023	880	974	1093	1171
0.5, 4.0	4516	2895	1417	695	357	247	225	240	244
0.5, 2.0	1346	1003	561	283	136	89	70	64	65
0.5, 1.0	377	319	211	117	59	39	27	24	22
0.5, 0.5	102	95	74	48	27	17	12	11	10
0.5, 0.25	28	27	25	19	13	8	7	6	6
0.5, 0.125	8	8	8	8	6	5	4	4	4
0.5, 0.0	1	1	1	1	1	1	1	1	1
0.25, 8.0	17378	9978	4092	1944	1017	833	936	1092	1166
0.25, 4.0	5194	3725	1805	812	380	249	225	241	242
0.25, 2.0	1455	1205	741	359	173	93	71	66	65
0.25, 1.0	391	354	269	160	74	43	28	23	22
0.25, 0.5	103	99	86	63	38	22	14	12	11
0.25, 0.25	28	28	27	23	16	10	8	7	7
0.25, 0.125	8	8	8	8	7	5	5	4	4
0.25, 0.0	1	1	1	1	1	1	1	1	1

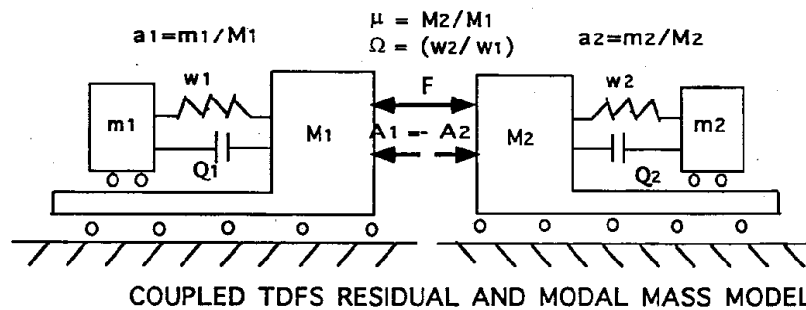
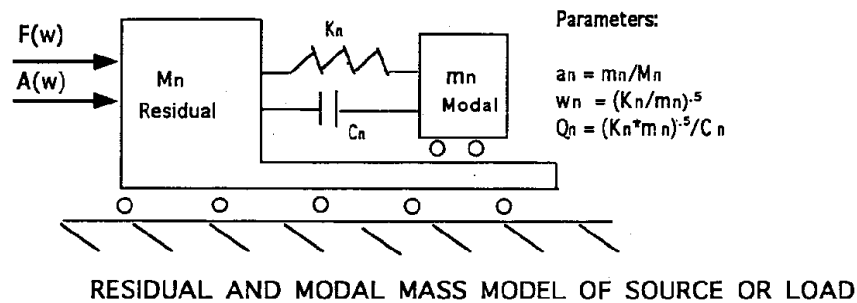
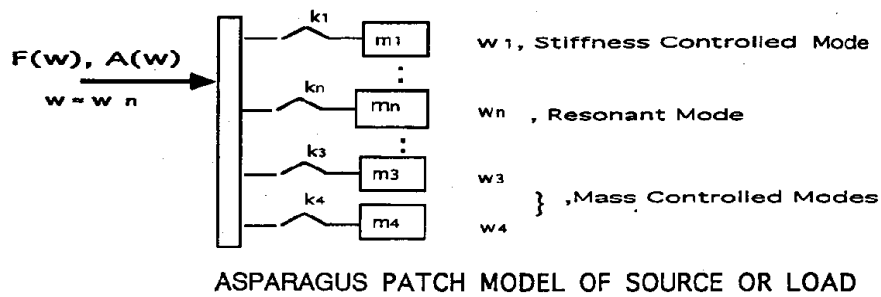

FIGURE 3. Complex TDFS With Residual and Modal Masses

5.1.3 Multiple Degree-of-Freedom Systems. In general, a multiple degree-of-freedom model of the source and payload may be utilized as in References 11 and 12. The model parameters are determined from modal mass and resonance frequency information for the source and payload. The ratio of the interface force envelope to the interface acceleration envelope should be evaluated as with simpler models, and the force limit should be determined by multiplying this ratio by the acceleration specification obtained as in conventional vibration tests.

5.1.4 Alternative Methods. Just as there are many ways of developing acceleration specifications, in the future there will be many ways of deriving force limits. A data base of flight and system test force data and validated semi-empirical methods may eventually become available, but for the present, force limits must often be derived from analytical models with

structural impedance data. Although the methods recommended in this handbook are preferred, other methods may be acceptable if they are rational and result in a desired margin over flight. One alternative method is to use the blocked force, which is the force that the source will deliver to an infinite impedance payload. Unfortunately for light loads, the blocked force is too large to result in much limiting as shown in Reference 9. Another method, which is recommended for low frequency testing, is to base the force limit on the CG acceleration used for quasi-static design, as discussed in Section 4.4.3.

5.2 Apparent and Effective Mass. The frequency response function (FRF), which is the ratio of the reaction force to applied acceleration at the base of a structure, is called “apparent mass.” The apparent mass is a complex impedance-like quantity which reflects the mass, stiffness, and damping characteristics of the structure. The modal models recommended herein require only the “effective” masses, which are real quantities and therefore are much simpler.

5.2.1 Effective Mass Concept. The concept of effective mass was developed in Reference 15. Consider the drive point apparent mass of the model consisting of the set of SDFS's connected in parallel to a rigid, massless base as shown in Figure 3, which is from Reference 8. The modal contribution to this drive-point apparent mass, divided by the SDFS frequency response factor, is called the effective mass of that mode. The sum of the effective modal masses for each excitation axis is equal to the total mass of the distributed system. The sum of the effective masses of the modes with resonance frequencies above the excitation frequency is called the effective residual mass. Appendix B provides a more general definition of effective mass and a procedure for using an FEM code such as NASTRAN to calculate the effective masses.

5.2.2 Shaker Measurement of Payload Effective Mass. The payload effective residual mass should be measured and used to update the calculated force limits when conducting a force limited vibration test of flight hardware, because the force limits in both the simple and complex TDFS models are proportional to the payload effective residual mass. Fortunately, the payload effective residual mass can be readily measured with a low level sine sweep, or random, test run when the payload is mounted with force gages on the shaker. First, the magnitude of the drive point apparent mass, the ratio of total reaction force in the excitation direction to the input acceleration, is measured. Then this apparent mass function is smoothed (a moving average in frequency) to eliminate the resonance peaks. The resulting smooth curve, which must be a decreasing function of frequency according to Foster's circuit theory theorem, is taken as the effective residual mass. In addition, the effective modal mass for each distinguishable mode may be evaluated by equating the corresponding peak in the apparent mass curve to the sum of the residual mass and the product of the effective modal mass times the quality factor Q, which may be determined from half-power bandwidth.

5.2.3 Tap Test Measurement of Source Effective Mass. The source effective residual mass is determined in a similar manner by smoothing the FRF's of the magnitude of the measured drive point apparent mass of the source. The source FRF's may be measured with a modal hammer incorporating a force gage. The measurements involve tapping at representative positions where the payload attaches and computing the FRF of the ratio of the force to the acceleration, which is measured with an accelerometer mounted temporarily on the source structure near the hammer impact point. (The payload must not be attached to the source structure during these measurements.) Some judgment is involved in combining the apparent masses measured at multiple attachment points to obtain a single-node model of the effective mass. At low frequencies, each point yields the total mass, unless rotations are

introduced. At high frequencies, the apparent masses from multiple points should be added, usually by summing the squares. Also when calculating or measuring the apparent mass of a mounting structure, it is important to decide how much of the adjacent structure it is necessary to consider. It is necessary to include only enough of the mounting structure so that the source effective modal and residual masses are accurately represented in the frequency range of the payload resonances.

6. COMPARISON OF FLIGHT AND GROUND VIBRATION TEST DATA

Two flight experiments in which vibration forces were measured are described herein. The flight measurements of vibration force and acceleration are compared with the corresponding data from the ground vibration tests of the payloads. The flight data from these two experiments provide validation of the force limiting method of vibration testing. For these two particular cases, the flight data can be modeled with the semi-empirical method described in section 4.4.2 with a C^2 of approximately 2. However, this should not be construed as a general result, since the value of C depends on the ratio of load to source effective mass, as shown in Figure 2.

6.1 SVF-2 Experiment on Space Shuttle (STS-96). Figure 4 is a photograph of the Shuttle Vibration Force experiment (SVF-2), which flew on STS-96 in May of 1999. (Reference 13) The SVF experiment also flew on shuttle flights STS-90 and STS-102, but no force data were obtained on those two flights. The SVF-2 experiment utilized a Hitchhiker (HH) canister attached to the shuttle sidewall via an adapter beam. The adapter beam also held a second HH experiment; the SVF-2 is the HH canister on the right in figure 4. Four tri-axial force gages were located between the SVF-2 canister and the adapter beam, and two triaxial accelerometers along with the signal processing and recorders were located inside of the canister. However, the accelerometer at the canister CG, which is the lower of the two accelerometers indicated in Figure 5, did not provide good data on the SVF-2 flight.



FIGURE 4: SVF-2 Experiment on STS-96

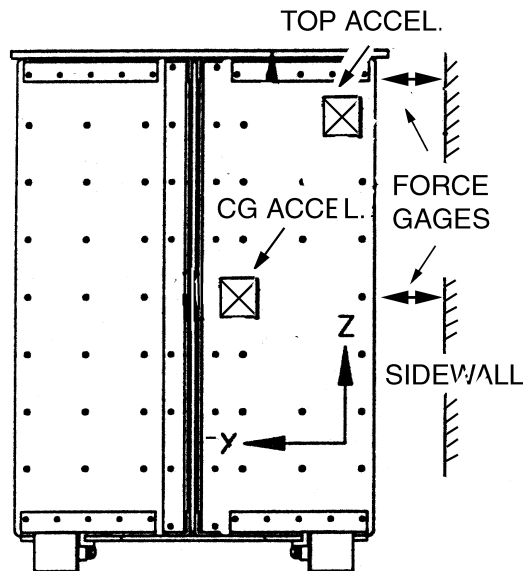

FIGURE 5: Hitchhiker Canister for SVF-2

For brevity, only the acceleration and force data measured in the Y-axis, which is normal to the shuttle sidewall is discussed. The Y-axis random vibration is generally larger than that in-plane, because acoustic excitation is the primary source of random vibration of the sidewall.

Figures 6 and 7 show the power spectral density (PSD) of the force and acceleration measured in the SVF-2 canister force-limited vibration qualification test, which was conducted approximately 2 years before the flight. The force limit of 10,000 lb²/Hz (Figure 6) for the vibration test was derived using the semi-empirical method of Equation (1b) with an input acceleration spectrum S_{AA} of 0.04 G²/Hz (Figure 7), a test item weight M_o of 230 lb (104 kg), and a C^2 of 4. (The calculated force limit of 8,464 lb²/Hz was rounded off to 10,000 lb²/Hz for the test. The break frequency, f_o , should have been taken as 160 Hz, the fundamental resonance of the canister on the shaker.)

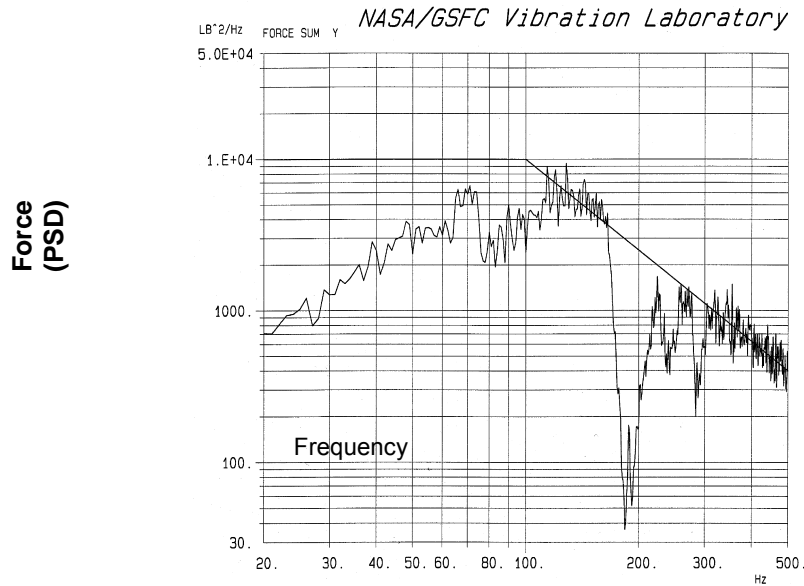

FIGURE 6. Force Limit in Vibration Test of SVF-2 Canister

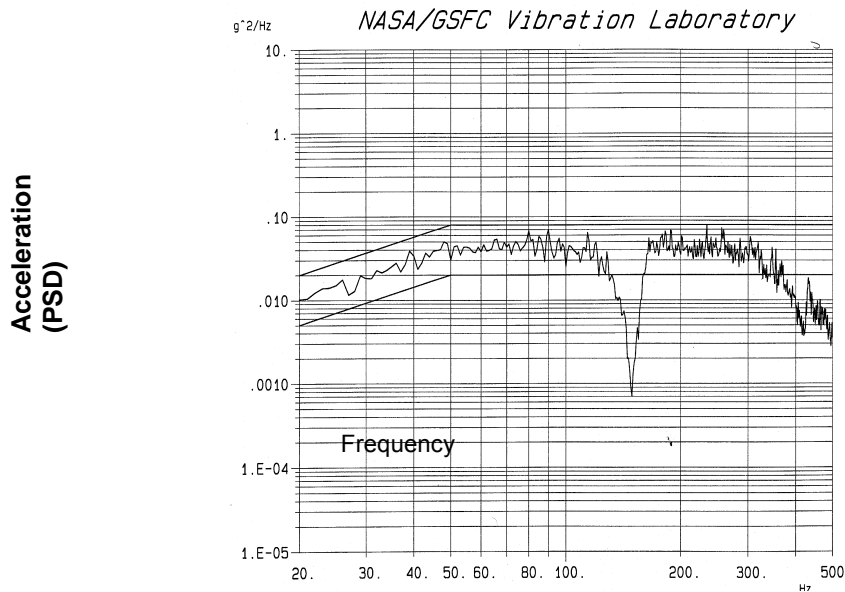

FIGURE 7: Acceleration Input in Vibration Test of SVF-2 Canister

The flight data shown herein are power spectral densities calculated during the time interval $7 < T < 9.5$ seconds after ignition of the shuttle main engine. The maximum acoustic and random vibration levels occurred during this time interval. The spectral analyses were conducted using MATLAB with an analysis bandwidth of 5 Hz.

Figure 8 shows the Y-axis acceleration measured in flight by the top accelerometer on SVF-2. The peaks in the flight acceleration spectrum of approximately $0.02 \text{ G}^2/\text{Hz}$ are a factor of two below the $0.04 \text{ G}^2/\text{Hz}$ (Figure 7) acceleration input specification for vibration qualification tests of SVF-2 canisters. This is compatible with the NASA standard 3 dB margin in NASA-STD-7001. However it should be recognized that the specification is for the adapter beam input to the canister, whereas the measured data are actually responses of the canister at a position relatively close to the adapter beam attachment. Measurements directly on sidewall mounted adapter beams for previous shuttle flights indicate that $0.01 \text{ G}^2/\text{Hz}$ is a typical value for the envelope of the input acceleration power spectral density. (Reference 14) The in-flight response measurements shown in Figure 8 are consistent with the thesis put forth in Reference 4 that there is little amplification between the vibration input and response in actual in-service configurations.

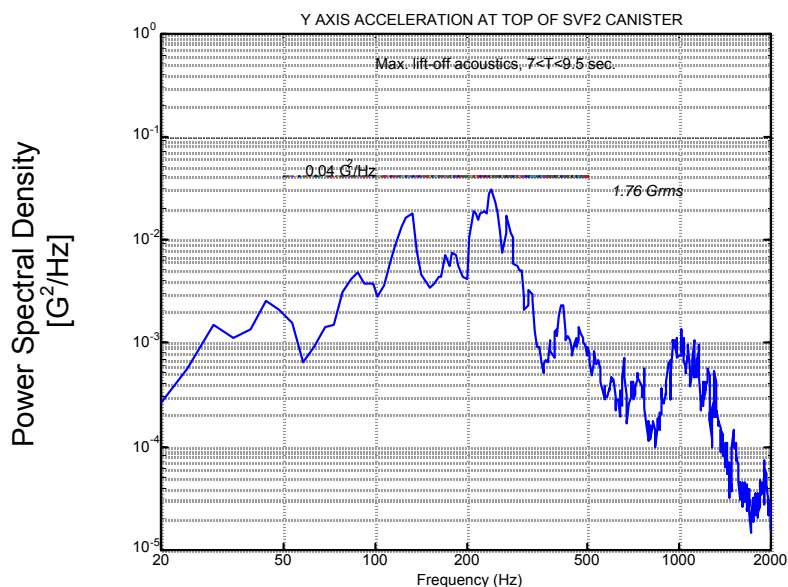

FIGURE 8: Y-Axis Acceleration at Top of SVF-2

Figure 9 shows the total Y-axis force measured in flight between the sidewall and the canister. The total force was obtained by summing in real time the Y-axis outputs of the four force gages located between the adapter beam and the canister. The measured in-flight PSD of force rolls off approximately 9 dB/octave at frequencies above 130 Hz, where it has a maximum value. The maximum force PSD of $1000 \text{ lb}^2/\text{Hz}$ (Figure 9) measured in flight is an order of magnitude less than the $10,000 \text{ lb}^2/\text{Hz}$ (Figure 6) PSD force limit used in the vibration test of the SVF-2 canister. Even with this relatively high force limit, a notch of 16 dB (Figure 7) resulted at the fundamental resonance frequency of the canister in the force limited vibration test.

If the flight input acceleration is assumed to have a maximum value of the acceleration PSD of $0.01 \text{ G}^2/\text{Hz}$, which is consistent with previous measurements of shuttle sidewall vibration reported in Reference 14 and with the response measurements in Figure 8, then Equation (1b) with the measured maximum value of the force PSD of $1000 \text{ lb}^2/\text{Hz}$ (Figure 9), and a canister weight of 230 lb (104 kg), yields a value of C^2 of 1.9 for the SVF-2 flight data.

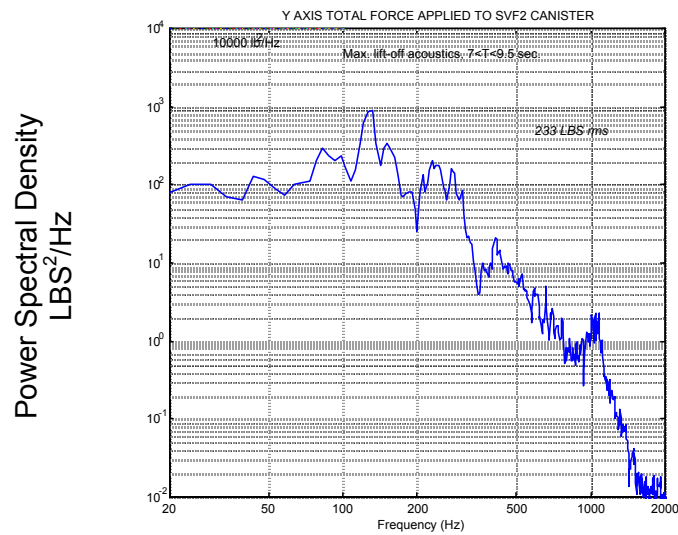

FIGURE 9: Total Y-Axis Force in SVF-2 Flight

6.2 CRIS Instrument on ACE Spacecraft

The flight data described in Reference 10 were measured at the interface of the Cosmic Ray Isotope Spectrometer (CRIS) instrument and the Advanced Composition Explorer (ACE) spacecraft. The data were recorded during a one second interval corresponding to the time of maximum acoustic loading during the lift-off of the Delta II 7920-8 launch vehicle. Figure 10 shows the 65 lb (30 kg) CRIS instrument mounted on the left side of the ACE spacecraft bus, which is a two-deck octagon honeycomb structure, 65 in. (1.6m) across and 40 in. (1m) high.

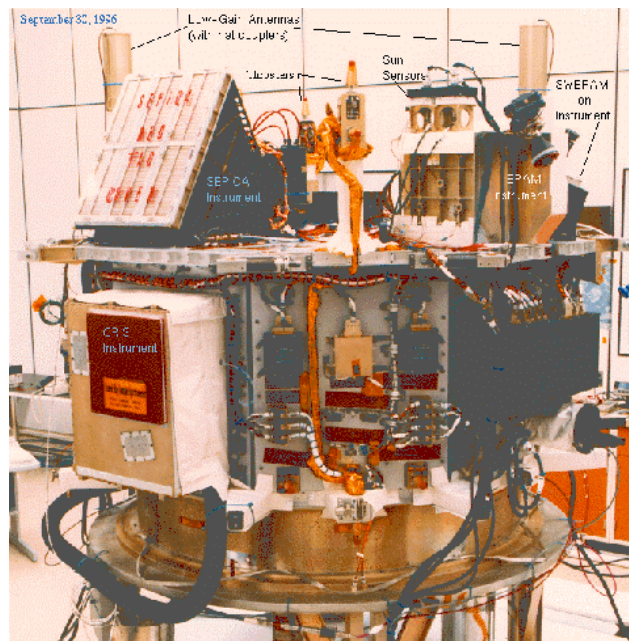

FIGURE 10. CRIS Instrument on ACE Spacecraft Bus

Figure 11 shows the total vertical force in the CRIS random vibration test and Figure 12 shows the notched acceleration input in the test. A low-level sine-sweep vibration test of the CRIS instrument mounted on the twelve force gages indicated that the gages read only about 83% of the total weight of the instrument, so the force gage PSD measurements in the vibration test, as well as in flight, must be increased by a factor of $(1/0.83)^2$ or 1.44. (The other 17% of the force goes through the force gage bolts.) Multiplying the 800 lbs.²/Hz force limit in Figure 10 by 1.44, and dividing by the square of the instrument weight of 65 lbs (30kg) and by the value of the acceleration specification of 0.12 G²/Hz, at 200 Hz yields a value for C² in Equation (1b) of approximately 2.3 for the vibration test.

Figure 13 shows the PSD of in-flight normal acceleration measured near one mounting foot of the CRIS instrument, and Figure 14 shows the PSD of in-flight normal force measured under the CRIS instrument. Both the in-flight force and acceleration PSD's peak at the coupled-system resonance frequencies, approximately 33 Hz and 135 Hz, which is a fundamental assumption of both the simple and the complex TDFS methods of computing force limits [2]. The in-flight force PSD decreases with frequency, above the 135 Hz resonance, where it has a maximum value. The coupled-system resonances occur at a lower frequency than the fundamental vertical resonance, just below 200 Hz, on the shaker. The flight interface acceleration data show a notch just below 200 Hz, due to the dynamic absorber effect associated with the fixed base resonance.

The maximum flight acceleration PSD of 0.001 G²/Hz in Figure 13 is two orders-of-magnitude lower than the acceleration PSD specification in the instrument random vibration test in Figure 12, and the maximum force PSD in Figure 14 is also approximately two orders of magnitude below the vibration test force limit in Figure 11. Even with this very high force limit, a notch of 7 dB (Figure 12) resulted at the fundamental resonance frequency of the instrument in the force limited vibration test.

The ratio of the measured in-flight force and acceleration PSD's at the 135 Hz resonance frequency, where the force is a maximum, is approximately 5000 lbs.². Applying Equation (1b) with the 1.44 force measurement correction factor and the instrument weight of 65 lb (30 kg), yields a value of C² of 1.7 for the CRIS flight data.

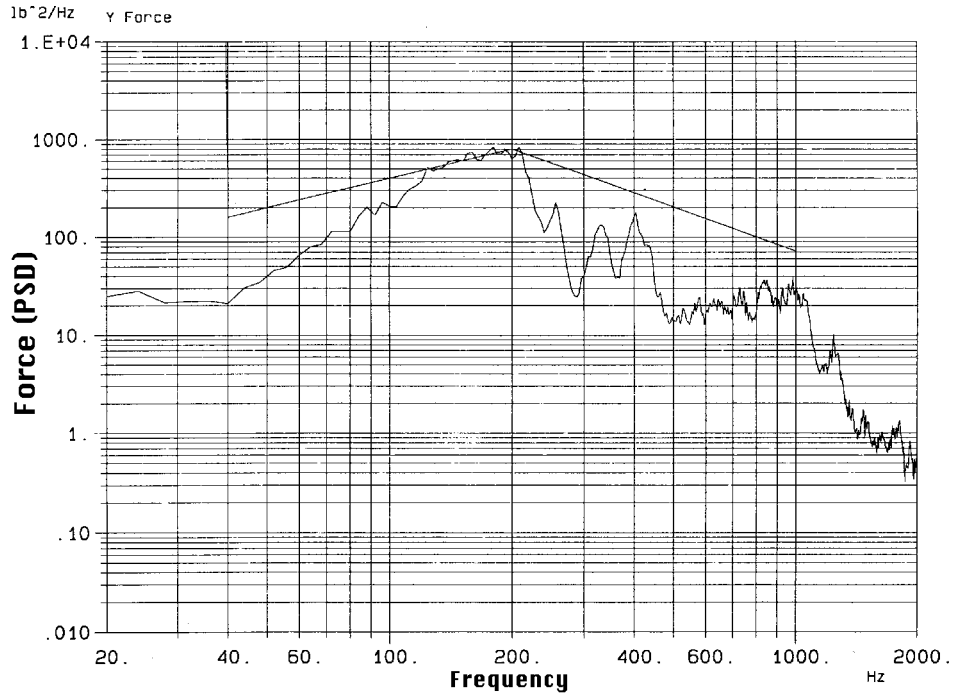

FIGURE 11. Total Vertical Force In CRIS Random Vibration Test

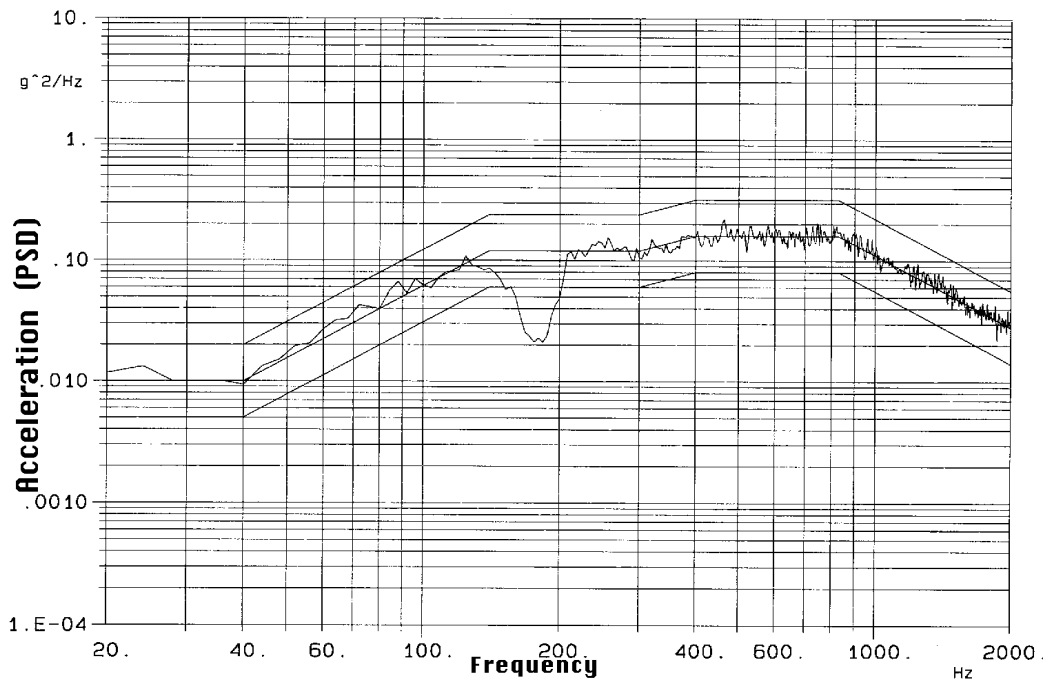

FIGURE 12. Notched Acceleration Input In CRIS Random Vibration Test

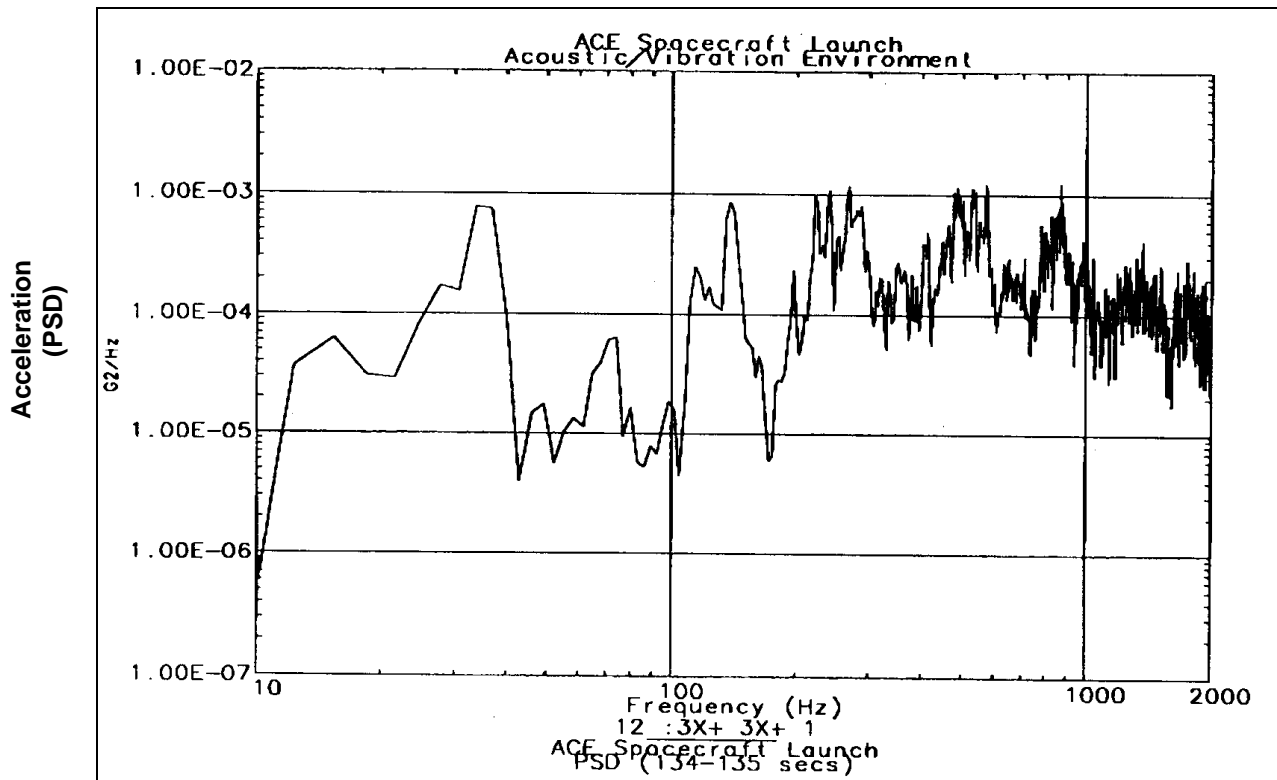

FIGURE 13. Spectral Density of In-Flight Normal Acceleration Measured Near One Mounting Foot of CRIS Instrument

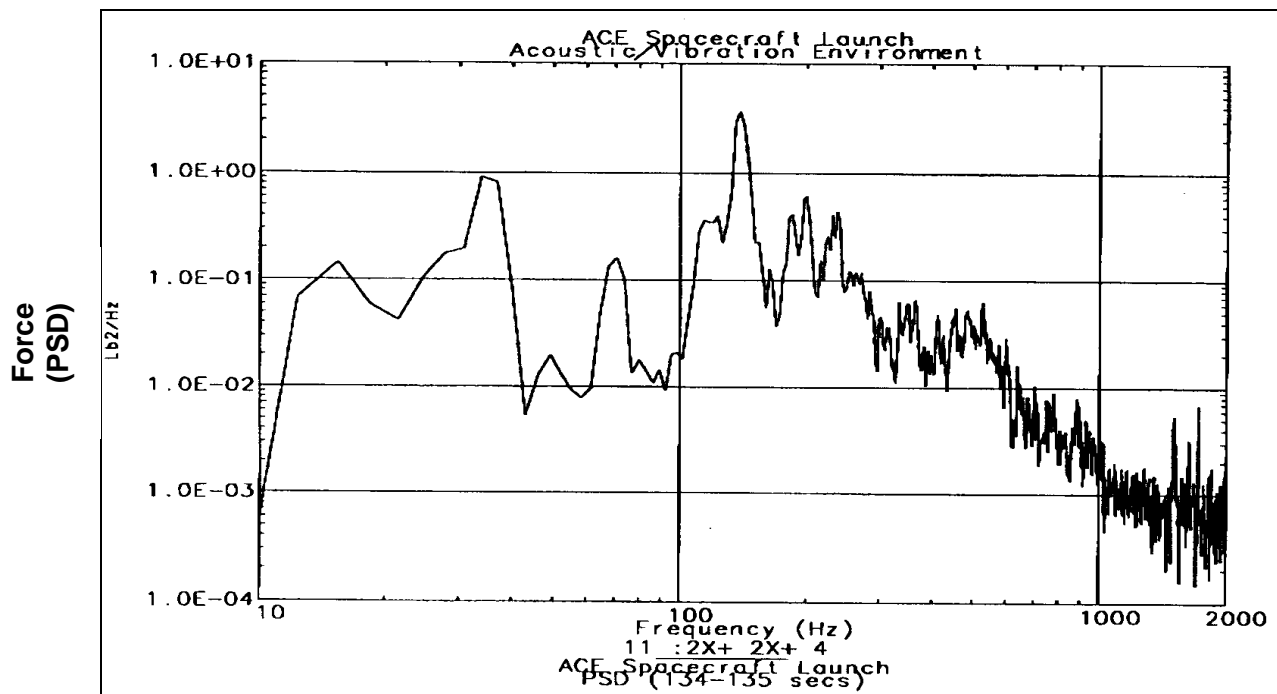

FIGURE 14. Spectral Density Of In-Flight Normal Force Measured Under CRIS Instrument

7. NOTES

7.1 Reduction of Mean-Square Response Due to Notching. It is often important to know how much the mean-square response, or force, will be reduced when a resonance is limited by notching the input acceleration. Limiting a response to the spectral density peak value, divided by the factor A squared, results in a notch of depth A squared in the input spectral density at the resonance frequency. The reduction in the mean-square response resulting from notching is considerably less than that associated with reducing the input spectral density at all frequencies. (In the latter case the response is reduced proportionally, e.g. a flat 6 dB reduction in the input spectrum yields a 6 dB reduction in the response spectrum and a factor of four reduction in the mean-square response.) The reduction in mean-square response of an SDFS resulting from notching the input $\text{dB} = 20 \log A$ at the response resonance frequency is shown in Figure 15, which is from Reference 9. Note from Figure 15 that a notch of approximately 14 dB is required to reduce the mean-square response by a factor of four! (A factor of four reduction in the mean-square corresponds to a factor of two reduction in the r.m.s. value and therefore in the peak value of the response.)

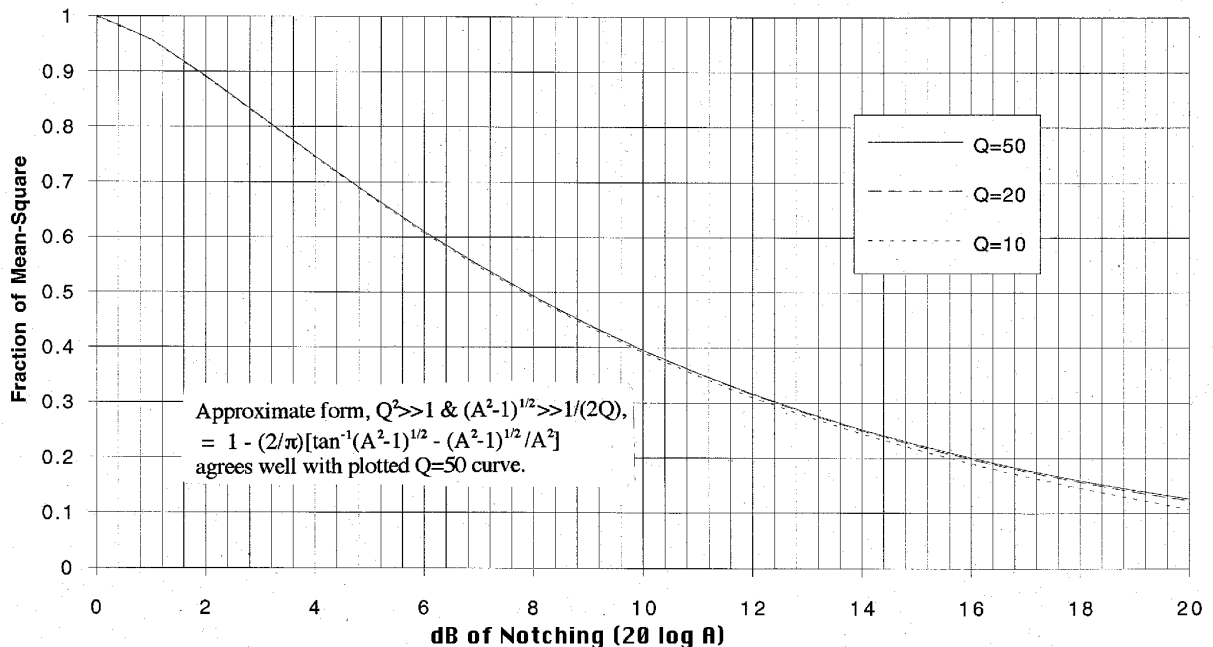

FIGURE 15. Reduction of SDFS Mean-Square Response by Notching

7.2 Force Specification Example. Appendix C is a spread sheet calculation of the force specification for an instrument (CRIS) mounted on a honeycomb panel of a spacecraft (ACE) using three methods: the simple TDFS, the complex TDFS, and the semi-empirical. Note that the acceleration PSD values in the table are rounded off to two significant figures, but the exact acceleration PSD values are used to calculate the force specifications in the table.

7.3 Definition of Symbols

A	=	interface acceleration
A_b	=	base acceleration
A_o	=	free acceleration of source
A_s	=	acceleration specification
c	=	dashpot constant
C	=	constant in semi-empirical method
F	=	interface force
F_s	=	force specification or limit
k	=	spring stiffness
k	=	physical stiffness matrix
M_o	=	total mass
M	=	residual mass
m	=	modal mass
<u>M</u>	=	apparent mass, F/A
m	=	physical mass matrix
M	=	modal mass matrix
Q	=	quality factor (amplification at resonance of SDFS)
S_{AA}	=	acceleration spectral density
S_{FF}	=	force spectral density
u	=	absolute displacements
U	=	generalized modal displacement
ϕ	=	mode shape
ω	=	radian frequency
ω_o	=	natural frequency of uncoupled oscillator

Subscripts

1	=	source oscillator
2	=	payload oscillator
F	=	unrestrained (free)
P	=	prescribed motion and rigid body set
N	=	modal set
n	=	single mode
p	=	reaction force direction
q	=	prescribed acceleration direction

Appendix A

Equations for Calculating the Simple TDFS Force Limits

The force limit is calculated for the TDFS in Figure 1 with different masses for the source and the payload oscillators. For this TDFS, the maximum response of the payload and therefore the maximum interface force occur when the uncoupled resonance frequency of the payload equals that of the source. For this case, the characteristic equation is that of a classical dynamic absorber, from Reference 8:

$$(\omega/\omega_0)^2 = 1 + (m_2/m_1)/2 \pm [(m_2/m_1) + (m_2/m_1)^2/4]^{0.5} \quad (A1)$$

where ω_0 is the natural frequency of one of the uncoupled oscillators, m_1 is the mass of the source oscillator, and m_2 is the mass of the load oscillator in Figure 1. The ratio of the interface force S_{FF} to acceleration S_{AA} spectral densities, divided by the magnitude squared of the payload dynamic mass m_2 , is:

$$S_{FF}/(S_{AA} m_2^2) = [1 + (\omega/\omega_0)^2/Q_2^2] / \{[1 - (\omega/\omega_0)^2]^2 + (\omega/\omega_0)^2/Q_2^2\} \quad (A2)$$

where Q_2 is the quality factor, one over twice the critical damping ratio, of the payload.

The force spectral density, normalized by the payload mass squared and by the acceleration spectral density, at the two-coupled system resonances is obtained by combining Equations (A1) and (A2). For this TDFS, the normalized force is just slightly larger at the lower resonance frequency of Equation (A1). The maximum normalized force spectral density, obtained by evaluating Equation (A2) at the lower resonance frequency, is plotted against the ratio of payload to source mass for three values of Q_2 in Figure 2.

This Page Left Blank Intentionally

Appendix B

Calculation of Effective Mass

Applying the rationale of Reference 15 and subdividing the displacement vector into unrestrained absolute displacements u_F and prescribed absolute displacements u_P , the equilibrium equation is:

$$\begin{bmatrix} m_{FF} & m_{FP} \\ m_{PF} & m_{PP} \end{bmatrix} \begin{Bmatrix} d^2u_F/dt^2 \\ d^2u_P/dt^2 \end{Bmatrix} + \begin{bmatrix} k_{FF} & k_{FP} \\ k_{PF} & k_{PP} \end{bmatrix} \begin{Bmatrix} u_F \\ u_P \end{Bmatrix} = \begin{Bmatrix} f_F \\ f_P \end{Bmatrix} \quad (B1)$$

Let: $\{u\} = \phi U = \begin{bmatrix} \phi_N & \phi_P \\ 0 & I_{PP} \end{bmatrix} \begin{Bmatrix} U_N \\ U_P \end{Bmatrix}$ (B2)

Where ϕ_N are normal modes and ϕ_P are rigid body modes associated with a kinematic set of unit prescribed motions, and U_N is the generalized modal relative displacement and U_P is the generalized prescribed absolute displacement. Substituting and pre-multiplying by ϕ_N^T yields:

$$\begin{bmatrix} M_{NN} & M_{NP} \\ M_{NP}^T & M_{PP} \end{bmatrix} \begin{Bmatrix} d^2U_N/dt^2 \\ d^2U_P/dt^2 \end{Bmatrix} + \begin{bmatrix} \omega_n^2 M_{NN} & 0 \\ 0 & 0 \end{bmatrix} \begin{Bmatrix} U_N \\ U_P \end{Bmatrix} = \begin{Bmatrix} F_N \\ F_P \end{Bmatrix} \quad (B3)$$

where: $M_{NN} = \phi_N^T m_{FF} \phi_N$ (B4)

$$M_{NP} = \phi_N^T m_{FF} \phi_P + \phi_N^T m_{FP} I_{PP} \quad (B5)$$

$$M_{PP} = I_{PP} m_{PP} I_{PP} + I_{PP} m_{PF} \phi_P + \phi_P^T m_{FP} I_{PP} + \phi_P^T m_{FF} \phi_P \quad (B6)$$

$$F_P = I_{PP} f_P + \phi_P^T f_F \quad (B7)$$

$$F_N = \phi_P^T f_F \quad (B8)$$

For: $d^2U_P/dt^2 = U_P = F_N = 0$, $d^2U_n/dt^2 = -\omega_n^2 U_n$, and $U_n = 1$:

$$M_{nP}^T = -F_P / \omega_n^2 \quad (B9)$$

where n indicates a single mode. (Note that M_{nP}^T is in mass units.) M_{nP}/M_{nn} is sometimes called the **elastic-rigid coupling** or the **modal participation factor** for the n th mode. If the model is restrained at a single point, the reaction (F_P) in (B8) is the SPCFORCE at that point in a NASTRAN modal analysis.

The initial value of M_{PP} is the rigid body mass matrix. If a Gaussian decomposition of the total modal mass in (B3) is performed, it subtracts the contribution of each normal mode, called the **effective mass**:

$$M_{nP}^T M_{nn}^{-1} M_{nP}, \quad (B10)$$

from M_{PP}^n , which is the **residual mass** after excluding the mass associated with the already processed n modes.

Consider the ratio of the reaction force in direction p , to the prescribed acceleration in direction q . The effective mass is the contribution of the n^{th} mode to this ratio, divided by the SDFS frequency response factor. The sum of the common-direction effective masses for all modes is equal to the total mass, or moment of inertia for that direction. The effective masses are independent of the modal normalization.

Appendix C

Force Specification Example

		APPENDIX C FORCE SPECIFICATION EXAMPLE															
		ACE SPACECRAFT CRIS INSTRUMENT Y-AXIS (NORMAL TO PANEL)															
		ζ = 0.025															
		Q = 20.00															
		ζ = 0.025															
Damping (Q = 50, 20, or 5)	Frequency (f)	40	50	63	80	100	125	160	200	250	315	400	500	630	800	1000	
	(ω) rad/sec	251	314	396	503	628	785	1005	1257	1571	1979	2513	3142	3958	5027	6283	
Acceleration PSD																	
SOURCE Eff Weight [lbs]		400.00															
Total Modal Weight (M1)		400.00															
NOTE 1:		251.95															
Total Modal Weight in Band		148.05															
Number of Modes in Band (N1)		1															
Band Aver. Modal Weight (m1)		148.05															
Ratio of Modal to Residual Weight (a1)		0.59															
LOAD Eff Weight [lbs]		66.00															
Total Modal Weight (M2)		66.00															
NOTE 1:		66.00															
Total Modal Weight in Band		0.00															
Number of Modes in Band (N2)		0															
Band Aver. Modal Weight (m2)		0.00															
Ratio of Modal to Residual Weight (a2)		0.17															
M2/M1 (Residual)		0.17															
MAX NORM FORCE (Simple)		9															
NOTE 2:		1															
MAX NORM FORCE (Complex)		1															
NOTE 2:		1															
Simple TDFS Force Spec. N [lb ² /Hz]		389.96															
Complex TDFS Force Spec. N [lb ² /Hz]		43.56															
Semi-empirical Force Spec. N [lb ² /Hz]		98.01															
NOTE 1: Residual weight of all higher frequency modes.																	
NOTE 2: Normalized by load residual mass squared and by acceleration																	
NOTE 3: See: "Vibration-Test Force Limits Derived from Frequency-Shift																	
AIAA Jour. Spacecraft and Rockets, pp. 312-316, March-April 1995.																	
NOTE 4: See: "Cassini Spacecraft and Instrument Force Limited Vibration																	
ESTEC, Noordwijk, The Netherlands, 24-27 June 1997; with C=1.5																	

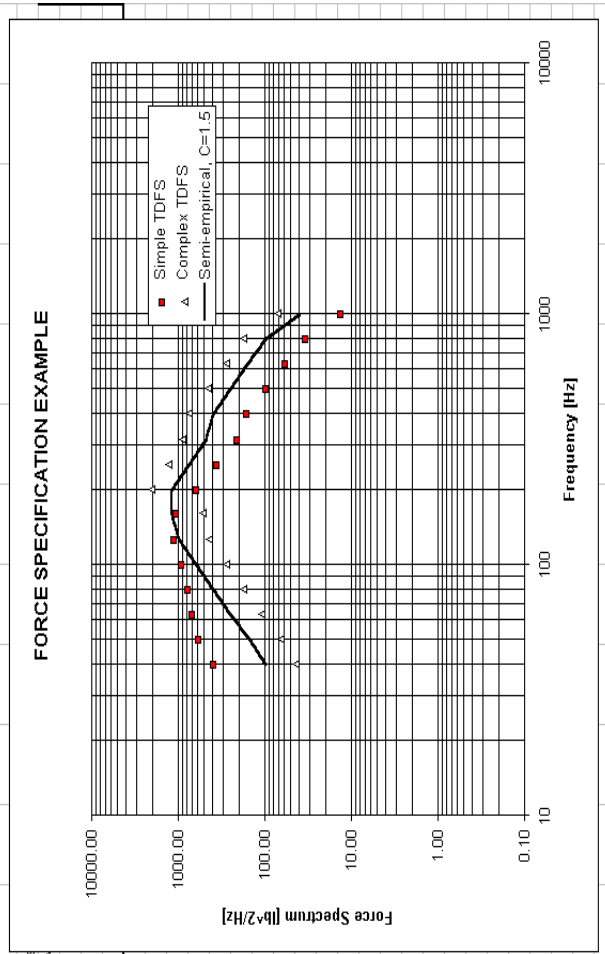

DOCUMENT HISTORY LOG, NASA-STD-7004

Status (Baseline/ Revision/ Canceled)	Document Revision	Effective Date	Description
Baseline		5-16-1996	Baseline Release
Revision	A	11-5-2002	Added New Section 6.0 "Comparison of Flight and Ground Vibration Test Data," which includes force data measured in two flight experiments. The flight data provide validation of the force limiting methodology. Made minor editorial changes.