	SPIRE CRYOGENIC THERMAL DESIGN REQUIREMENTS	SPIRE-RAL-PRJ-002075 Date: 13-Jan-06 Issue: Issue 1
---	--	--

SPIRE CRYOGENIC THERMAL DESIGN REQUIREMENTS

Issue 1

THERMAL ENGINEERING GROUP				
PREPARED BY:	A.S. GOIZEL	(RAL)	13-01-06	
CHECKED BY:	B. SHAUGHNESSY	(RAL)	13-01-06	

SPIRE PROJECT TEAM				
CHECKED BY:	B. SWINYARD	(RAL)	13-01-06	
	B.WINTER	(MSSL)		
	P. HARGRAVE	(Cardiff)		
	D. POULIQUEN	(LAM)		
	P. PARR-BURMAN	(ATC)		
	L.DUBAND	(CEA)		
	J. BOCK	(JPL)		
APPROVED BY:	E. SAWYER	(RAL)	13-01-06	



**SPIRE CRYOGENIC
THERMAL DESIGN REQUIREMENTS**

SPIRE-RAL-PJR-002075

Date: 13-Jan-06

Issue: Issue 1

"Page intentionally left blank"

	SPIRE CRYOGENIC THERMAL DESIGN REQUIREMENTS	SPIRE-RAL-PJR-002075 Date: 13-Jan-06 Issue: Issue 1
---	--	--

CHANGE RECORD

<i>Issue</i>	<i>Date</i>	<i>Section</i>	<i>Change</i>
Draft A	19-06-04	-	New Document formalising parts of RD9
Draft B	13-07-04	Acronym List	Few missing acronyms added
		7/8/9/10	Section titles changed to "Thermal Design Requirements" for consistency
		3.1	Figure 3.1.1 corrected
		3.2.1	Added footnote
		3.2.2	Added note for DD2
		4	Section removed
		5.2	Added explanatory note describing the difference between Herschel requirements and goals
		6.2.1	Note reworded
		6.2.2	"Maximum Power" in Table 6.2.2 replaced by "Maximum Energy"
		7.1	Added figure 7.1.1.
		8.3	Note added on mechanism power dissipation requirement. Housekeeping harness heat leak still TBC.
		9	Added maximum allowable JFET cryo-harness heat leak, still TBC
		11	Section removed as an identical section is already in the Thermal Configuration Control Document
Issue 1	13-01-06	2.2	Add the IRD and IIDA as reference documents.
		5.2	Correct typo in table 5.2.1.
		6.2.1	Update the temperature requirement at the BDA assembly thermal interface and maximum temperature drift in table 6.2.1 to be consistent with the IRD. Reference to IRD added.
		6.3.1	Reference to IRD added to Table 6.3.1.
		6.3.2	Update the Reqt-SP-02 and Reqt-SP-03 with the missing goal value in table 6.3.2. Reference to IRD added.
		6.4.1	Reference to IRD added in table 6.4.1.
		6.4.2	30 μ W cooler total load requirement explicitly added to table 6.4.2 as derived requirement Reqt-SP-21 for clarity. Reference to IRD added in table 6.4.2.
		Table 7.2.2	Reference to IRD added in table 7.2.2.
		Table 7.3.2	Remove reference in table 7.3.2 as not applicable.
		All	Reference to RD8 now includes section number.
		All	"Gross" cooler load replaced with "Total" cooler load for clarity.
		7.4.2	Req-SP-10 in table 7.4.2 reworded for clarity. Requirement Reqt-SP-21 created in table 7.4.2. Req-SP-22 Added to document as it was missing. Note 3 added for clarity.
		8.3	Requirement Reqt-SP-23, 24, 26 created in table 8.3.1. Req-SP-25 Added to table 8.3.1 as it was missing. Table 8.3.2 and 8.3.3 deleted and mechanisms Maximum Mean Power Dissipation explicitly added to table 8.3.1 as derived requirement Reqt-SP-27 to 31 for clarity.
		9.2	Maximum allowable SJFET power dissipation added to table 9.2.1 as was missing, consistent with the IIDB.
		9.3	Update the Reqt-Sp-20 in table 9.3.1 with the goal value from IIDA as was missing. Requirement Reqt-SP-32 and 33 created in table 9.3.1.



SPIRE CRYOGENIC THERMAL DESIGN REQUIREMENTS

SPIRE-RAL-PJR-002075

Date: 13-Jan-06

Issue: Issue 1

ACRONYM LIST

BDA	Bolometer Detector Array
² He	Helium 2
³ He	Helium 3
BSM	Beam Steering Mechanism
CQM	Cryogenic Qualification Model
DD	Design Driver
DTMM	Detailed Thermal Mathematical Model
ECR	Engineering Change Request
FPU	Focal Plane Unit
GMM	Geometrical Mathematical Model
HOB	Herschel Optical Bench
ITMM	Interface Thermal Mathematical Model
JFET	Junction Field Effect Transistor
L0	Temperature Level 0 (~1.7K)
L1	Temperature Level 1 (~4K)
L2	Temperature Level 2 (~12K)
L3	Temperature Level 3 (~15K)
PCAL	Photometer Calibration Source
PFM	Proto-Flight Model
PJFET	Photometer JFET
PTC	Photometer Thermal Control
RTMM	Reduced Thermal Mathematical Model
SCAL	Spectrometer Calibration Source
SJFET	Spectrometer JFET
SMEC	Spectrometer Mechanism
SOB	SPIRE Optical Bench
SPIRE	Spectral and Photometric Imaging Receiver
SST	Stainless-steel
STP	Screened Twisted Pairs
TBC	To Be Confirmed
TBD	To Be Defined
TMM	Thermal Mathematical Model



SPIRE CRYOGENIC THERMAL DESIGN REQUIREMENTS

SPIRE-RAL-PJR-002075
Date: 13-Jan-06
Issue: Issue 1

CONTENT

1.	SCOPE	1
2.	DOCUMENTATION	2
2.1	Applicable Documents	2
2.2	Reference Documents	2
3.	SPIRE ENVIRONMENT AND THERMAL DESIGN OVERVIEW	4
3.1	Herschel Thermal Environment Overview	4
3.2	SPIRE Thermal Design Overview	6
3.2.1	SPIRE Requirements Overview	6
3.2.2	Cooler Recycling Performance Design Drivers	7
3.2.3	Cooler Operation Performance Design Drivers	8
4.	SPIRE THERMAL REQUIREMENT ORGANISATION	10
5.	SPIRE INTERFACES WITH HERSCHEL THERMAL REQUIREMENTS	11
5.1	Overview	11
5.2	HERSCHEL Interfaces Thermal Requirements	12
6.	SPIRE 300-MK LEVEL THERMAL DESIGN REQUIREMENTS	13
6.1	Overview	13
6.2	BDA Detectors and PTC Control Hardware	14
6.2.1	High Level Thermal Requirements	14
6.2.2	Derived Thermal Requirements	15
6.3	300-mK Busbar System	16
6.3.1	High Level Thermal Requirement	16
6.3.2	Derived Thermal Requirement	16
6.4	³ He Sorption Cooler	19
6.4.1	High Level Thermal Requirement	19
6.4.2	Derived Thermal Requirement	19
7.	SPIRE LEVEL-0 THERMAL DESIGN REQUIREMENTS	21



SPIRE CRYOGENIC THERMAL DESIGN REQUIREMENTS

**SPIRE-RAL-PJR-002075
Date: 13-Jan-06
Issue: Issue 1**

7.1	Overview	21
7.2	Level-0 Evaporator Strap	23
7.2.1	High Level Thermal Requirement	23
7.2.2	Derived Thermal Requirement	23
7.3	Level-0 Pump Strap	25
7.3.1	High Level Thermal Requirement	25
7.3.2	Derived Thermal Requirement	25
7.4	Level-0 Enclosures Strap Sub-system	27
7.4.1	High Level Thermal Requirement	27
7.4.2	Derived Thermal Requirement	27
8.	SPIRE LEVEL-1 THERMAL DESIGN REQUIREMENTS	29
8.1	Overview	29
8.2	High Level Thermal Requirement	30
8.3	Derived Thermal Requirement	30
9.	SPIRE LEVEL-2 / LEVEL-3 THERMAL DESIGN REQUIREMENTS	32
9.1	Overview	32
9.2	High Level Thermal Requirement	32
9.3	Derived Thermal Requirement	32



SPIRE CRYOGENIC THERMAL DESIGN REQUIREMENTS

SPIRE-RAL-PJR-002075
Date: 13-Jan-06
Issue: Issue 1

LIST OF FIGURES

Figure 3.1-1 – SPIRE Thermal Design and Environment	5
Figure 3.2-1 - Typical profile of condensation efficiency versus evaporator temperature [AD1].	7
Figure 3.2-2 - Typical profile of cryo-pumping efficiency versus evaporator temperature [AD1].	7
Figure 3.2-3 – Cooler hold time versus overall recycling efficiency and evaporator total load [AD1].	8
Figure 3.2-4 – Cooler Cold Tip Temperature versus External Load [AD2]	8
Figure 5.1-1 - HERSCHEL Cryostat / SPIRE Instrument Interfaces Definition	11
Figure 6.1-1 - SPIRE 300-mK Assembly Overview	13
Figure 6.3-1 – Applicable load for given sections of the 300-mK Busbar	18
Figure 7.1-1 – SPIRE and Herschel Level-0 Straps/Pods interface Description	21
Figure 7.1-2 – Level-0 Spectrometer and Photometer Enclosures Strap Assembly	22
Figure 7.4-1 – Level-0 Enclosure Temperature versus Cooler Hold Time [AD5]	27

	SPIRE CRYOGENIC THERMAL DESIGN REQUIREMENTS	SPIRE-RAL-PJR-002075 Date: 13-Jan-06 Issue: Issue 1
---	--	--

LIST OF TABLES

Table 2.1-1 – Applicable Documents	2
Table 2.2-1 – Reference Documents	3
Table 3.1-1 – SPIRE Thermal Interfaces with the different Herschel cryostat temperature stages	4
Table 3.2-1 – Cooler Performances Design Drivers	6
Table 5.2-1 - HERSCHEL Interfaces Thermal Requirements [Section 5.7.1.3 - RD8]	12
Table 6.2-1 – BDA Detectors and PTC High Level Requirements [RD1]	14
Table 6.2-2 - PTC Derived Thermal Requirement	15
Table 6.3-1 – 300-mK Busbar High Level Thermal Requirements [RD2]	16
Table 6.3-2 – 300-mK Busbar Derived Thermal Requirement	16
Table 6.3-3 - BDA strap interface temperatures Analysis	16
Table 6.3-4 – Nominal Load for various 300-mK subsystems	17
Table 6.3-5 - Nominal Loads seen on the various section of the 300-mK Photometer Busbar	17
Table 6.3-6 - Nominal Loads seen on the various section of the 300-mK Spectrometer Busbar	17
Table 6.4-1 – Sorption Cooler High Level Requirements [RD3]	19
Table 6.4-2 – Sorption Cooler Derived Thermal Requirements	19
Table 6.4-3 - 300-mK Sub-system Parasitic Load Breakdown	19
Table 7.2-1 – Level-0 Evaporator Strap High-Level Requirement	23
Table 7.2-2 – Level-0 Evaporator Strap Derived Thermal Requirements	24
Table 7.3-1 - Level-0 Pump strap High-Level Requirements	25
Table 7.3-2 - Level-0 Pump Strap Derived Requirement	25
Table 7.4-1 - Level-0 Enclosures Straps High-Level Requirement	27
Table 7.4-2 - Level-0 Enclosures Straps Derived Requirements	28
Table 8.2-1 - Level-1 FPU High-Level Requirement	30
Table 8.3-1 - Level-1 FPU Derived Requirements	31
Table 9.2-1 – Photometer and Spectrometer JFET High-Level Requirements	32
Table 9.3-1 - Photometer and Spectrometer JFET Derived Requirements	32

	SPIRE CRYOGENIC THERMAL DESIGN REQUIREMENTS	SPIRE-RAL-PJR-002075 Date: 13-Jan-06 Issue: Issue 1
---	--	--

1. Scope

SPIRE is an infrared instrument aiming to operate detectors at a cryogenic temperature of 300mK for observation periods of at least 46 hours. This performance is possible thanks to a cryo-cooler mounted inside the instrument to which the detectors are connected. In order to achieve this performance however, stringent thermal requirements are applicable to the various sub-systems of the instrument in the common goal to minimise heat leak into and dissipated within the instrument.

This document summarises the high-level thermal requirements applicable to each instrument subsystem. Most of these requirements have been design drivers for lower sub-systems for which “derived requirements” have been defined. Moreover, as the cooler performance has been more fully understood and for others reasons, requirements have been evolved by “Engineering Change Request” (ECR) and are now all also summarised here as “derived requirements”.

Section 2 of this document provides the references for additional supporting material while section 3 gives a short description of the SPIRE instrument thermal environment and thermal.

Section 4 introduces the sections 5 to 9, where a detailed statement of the high-level and derived thermal requirements applicable to the SPIRE sub-systems is given for the various temperature stages.

The Flight Detailed Thermal Mathematical Model (DTMM) [AD5] uses values given herein to predict SPIRE thermal performances. A description of the predicted instrument flight performances and how they compare with the requirements defined in this document is given in the “Thermal Configuration Control Document” [RD9].

	SPIRE CRYOGENIC THERMAL DESIGN REQUIREMENTS	SPIRE-RAL-PJR-002075 Date: 13-Jan-06 Issue: Issue 1
---	--	--

2. Documentation

2.1 Applicable Documents

ID	Title	Number
AD1	SPIRE Cooler Performance Spreadsheet	Cooler_Performances.xls
AD2	SPIRE CQM Cooler test results	HSO-SBT-TN-091 15-Dec-03 Issue: 1.1
AD3	Not Used	
AD4	Document / Engineering Change Request	HR-SP-RAL-ECR-054 13-May-03
AD5	SPIRE Flight Model - Esatan DTMM Logfile	SPIRE Models Log 21 DTMM.xls
AD6	Draft Minute Notes from Visit to CEA-SBT	19-Jun-03
AD7	SPIRE Instrument Timeline Definition v2 - reviewed.doc	19-Nov-02
AD8	SPIRE Thermal Model Model	SPIRE_TMM_FM_2-3.d

Table 2.1-1 – Applicable Documents

2.2 Reference Documents

ID	Title	Number
RD1	Herschel Spire Detector Subsystem Specification Document	SPIRE-JPL-PRJ-000456 07-Jan-03 Issue 3.2
RD2	Herschel/SPIRE 300-mK Strap System Requirements	SPIRE-RAL-PRJ-001323 04-Jun-02 Draft 0.1
RD3	SPIRE & PACS sorption Cooler Specifications	HSO-SBT-SP-001 18-Mar-04 Issue 3.6
RD4	Photometer Calibrator – Subsystem Specification Document	SPIRE-QMW-PRJ-001101 07-Sep-01 Issue 1.0
RD5	Spectrometer Calibrator – Subsystem Specification Document	SPIRE-QMW-PRJ-001105 07-Sep-01 Issue 1.0
RD6	SPIRE Beam Steering Mirror Subsystem Specification Document	SPIRE-ATC-PRJ-000460 11-Sep-03 Issue 3.7
RD7	Herschel Spire Spectrometer Mirror Mechanism Subsystem Specification Document	SPIRE-LAM-PRJ-000459 12-Oct-01
RD8	Instrument Interface Document Part B SPIRE Instrument	SPIRE-ESA-DOC-000275 01-Mar-04 Issue 3.2
RD9	SPIRE Thermal Configuration Control Document	SPIRE-RAL-PRJ-000560 16-Jul-04 Draft 12
RD10	Instrument Interface Document Part A	SCI-PT-IIDA-04624

	SPIRE CRYOGENIC THERMAL DESIGN REQUIREMENTS	SPIRE-RAL-PJR-002075 Date: 13-Jan-06 Issue: Issue 1
---	--	--

		3.3
RD11	SPIRE Instrument Requirement Document	SPIRE-RAL-PRJ-000034 Issue 1.3
RD12	Temperature Stability Requirements for SPIRE	SPIRE-JPL-NOT-000623

Table 2.2-1 – Reference Documents

	SPIRE CRYOGENIC THERMAL DESIGN REQUIREMENTS	SPIRE-RAL-PJR-002075 Date: 13-Jan-06 Issue: Issue 1
---	--	--

3. SPIRE Environment and Thermal Design Overview

3.1 Herschel Thermal Environment Overview

The SPIRE instrument will be launched onboard Herschel Space Observatory in 2007, along with the PACS and the HIFI instruments. SPIRE consists of five bolometer arrays, which will be cooled and controlled to an absolute temperature of 310-mK for nominal observation periods of 46 hours. To achieve such a low temperature, SPIRE will interface with four temperature stages of the Herschel cryostat nominally operating at 15K, 12K, 4K and 1.7K. The final 300-mK temperature stage is provided by a Helium 3 (³He) sorption cooler onboard SPIRE itself.

The SPIRE Focal Plane Unit (FPU) is mounted off the Herschel Optical Bench (HOB) at 12K on isolating supports to limit the parasitic loads into the instrument. Two JFET electronic boxes also mounted off the HOB are thermally coupled to the 15K stage of the Herschel cryostat to heat sink most of their internal power dissipation during operation. The JFET electronic boxes connect to SPIRE FPU through low conductance harnesses to reduce their heat leak into the instrument. The SPIRE FPU is thermally coupled to the 4K stage of the Herschel cryostat to heat sink most of the parasitic loads from the 12K stage as well as the additional heat dissipated by the various mechanisms mounted inside the FPU. The 300-mK detectors are bolted on internal enclosures. These enclosures are mounted off the SPIRE Optical Bench (SOB) on isolation supports and are thermally coupled to the 1.7K stage of the Herschel cryostat. The last 300-mK temperature stage is provided by a ³He sorption cooler mounted off the SOB, with its cold tip connected to each detector through an arrangement of thermal straps. This cooler operates a 48-hour cycle, which consists of 2-hour of recycling, during which the cooler ³He is being regenerated, followed by a nominal 46-hour operation period¹ during which the detectors are cooler to an absolute temperature of 310mK. A thermal control has also been implemented on the 300-mK photometer strap to maintain the detector temperatures as stable as possible.

The table 3.1-1 below and figure 3.1-1 on next page, briefly describe how the different SPIRE subsystems interconnect with the various Herschel cryostat temperature stages.

<i>Temperature Stages</i>		<i>SPIRE Sub-systems</i>	<i>Herschel Thermal Interfaces</i>
Level-3	~ 15K	Photometer and Spectrometer JFET Electronic Boxes	Each JFET electronic box is coupled to the Herschel Level-3 ventline via a thermal strap.
Level-2	~ 12K	FPU	Mounted off the HOB on 3 isolating supports.
		Photometer JFET	Mounted off the HOB on 5 isolating supports.
		Spectrometer JFET	Mounted off the HOB on 4 isolating supports.
Level-1	~ 4K	SOB	Coupled to the Herschel Level-1 ventline via two thermal straps.
Level-0	~ 1.7K	Cooler Evaporator	Coupled to the Herschel Level-0 ² He tank via a thermal strap.
		Cooler Pump	Coupled to the Herschel Level-0 ² He tank via a thermal strap.
		L0 Spectrometer Enclosure	Coupled to the Herschel Level-0 ² He tank via a thermal strap.

Table 3.1-1 – SPIRE Thermal Interfaces with the different Herschel cryostat temperature stages

¹ This fits in with Herschel ground commanding periods.

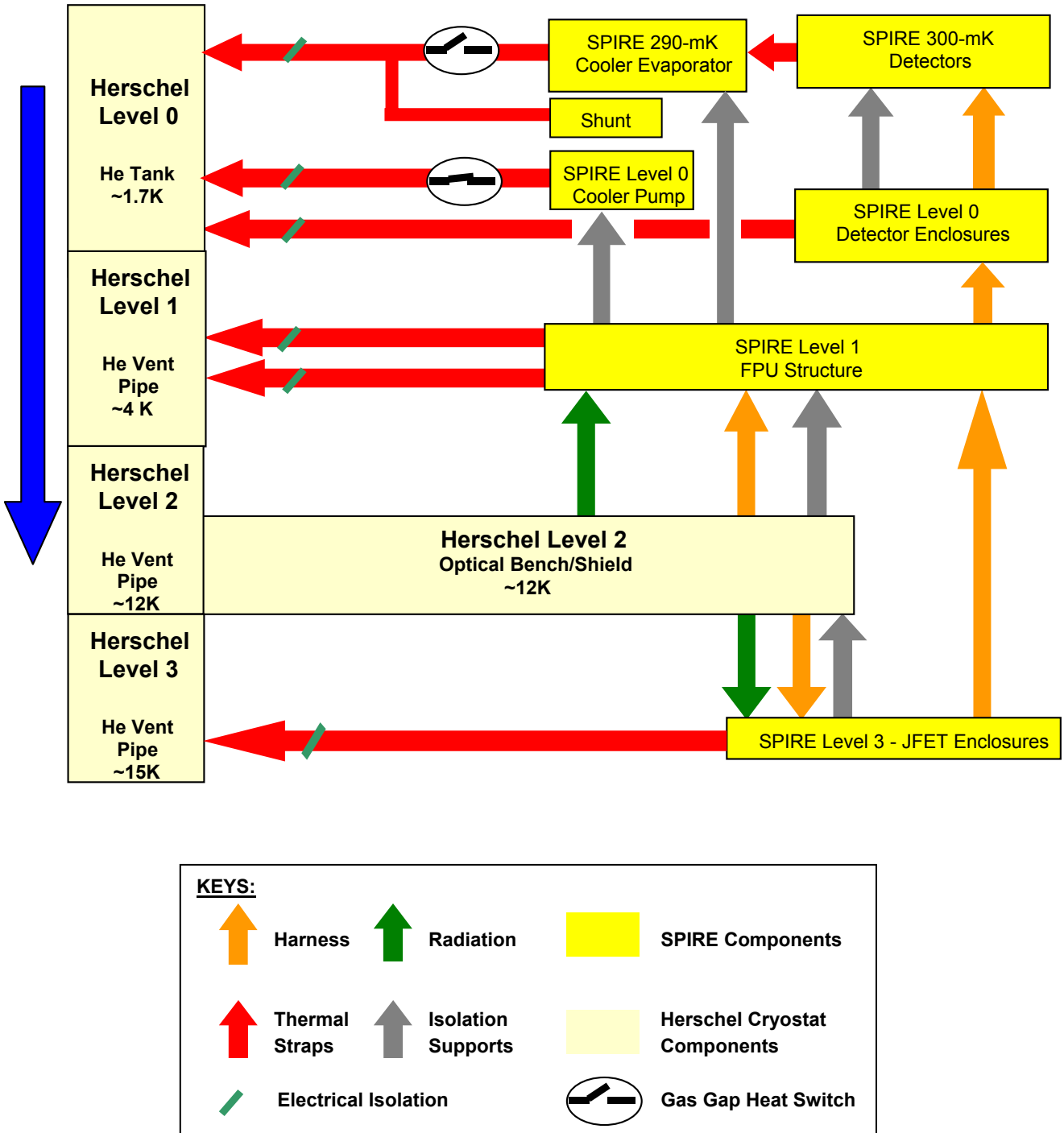

Figure 3.1-1 – SPIRE Thermal Design and Environment

3.2 SPIRE Thermal Design Overview

3.2.1 SPIRE Requirements Overview

To achieve its scientific goals, the SPIRE instrument must be able to run its bolometer arrays for a minimum period of 46 hours at a maximum absolute temperature of 310mK.

To achieve the above requirement, the instrument will be using a 6-litre² ³He sorption cooler mounted inside the SPIRE FPU on the optical bench which, when operated in an optimised thermal environment, can provide a “cold tip” temperature as low as 265mK for operation periods exceeding 60 hours.

The cooler *hold time* and *cold tip temperature* are both highly dependent on the thermal environment in which the cooler is being operated and it is important to have a clear understanding of how the SPIRE thermal design can affect the cooler performances:

- The cooler **hold time** is dependent on the total amount of ³He gathered in the evaporator at the beginning of the “low temperature” cooler phase (when the cold tip is at ~300mK) as well as on the rate at which the ³He is subsequently being evaporated.
- The cooler **cold tip temperature** is dependent on the total load seen by the evaporator during the “low temperature” phase. This load consists of the cooler own internal parasitic load as well as the external load from the 300-mK detector assembly.

The table 3.2.1 below provides an overview of the main design drivers for the SPIRE instrument thermal architecture.

<i>ID</i>	<i>Design Drivers</i>	<i>Description</i>	<i>Applicable</i>
DD1	Maximise the cooler condensation efficiency	Allow to optimise the amount of ³ He available for the detector operation.	During recycling
DD2	Maximise the cooler cryo-pumping efficiency	Allow to optimise the amount of ³ He available for the detector operation.	During recycling
DD3	Minimise the cooler total evaporator load	Allow the limit the rate at which the ³ He is being evaporated following the recycling phase.	During operation
		The lower the load on the evaporator, the cooler the cold tip temperature.	During operation

Table 3.2-1 – Cooler Performances Design Drivers

The following paragraphs provide an overview of the cooler performances for each of the design drivers described in the above table.

² The “6-litre” description defines the amount of ³He it contains as being at least 6 litres.



SPIRE CRYOGENIC THERMAL DESIGN REQUIREMENTS

SPIRE-RAL-PJR-002075
Date: 13-Jan-06
Issue: Issue 1

3.2.2 Cooler Recycling Performance Design Drivers

The overall cooler recycling efficiency is driven by:

- The condensation efficiency [DD1], which is dependent on the evaporator temperature at the end of the condensation phase (for a given pump temperature).

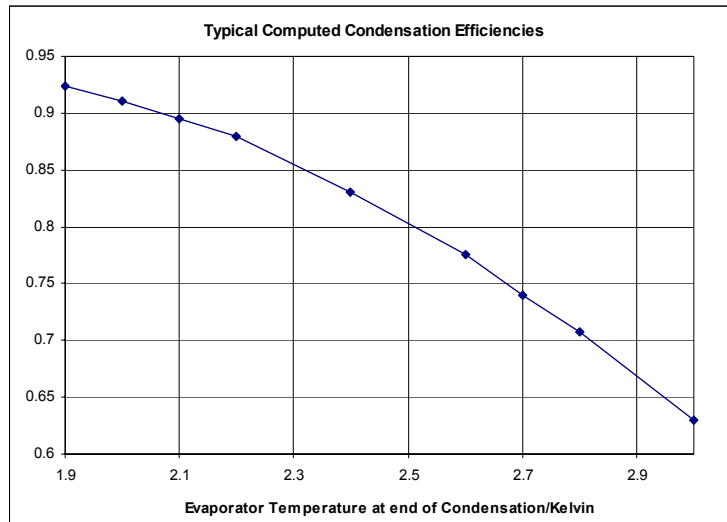

Figure 3.2-1 - Typical profile of condensation efficiency versus evaporator temperature [AD1].

- The cryo-pumping efficiency [DD2], which depends on the evaporator temperature at the end of the condensation phase. This takes into account the helium used to cooldown from recycling temperature to cold operation.

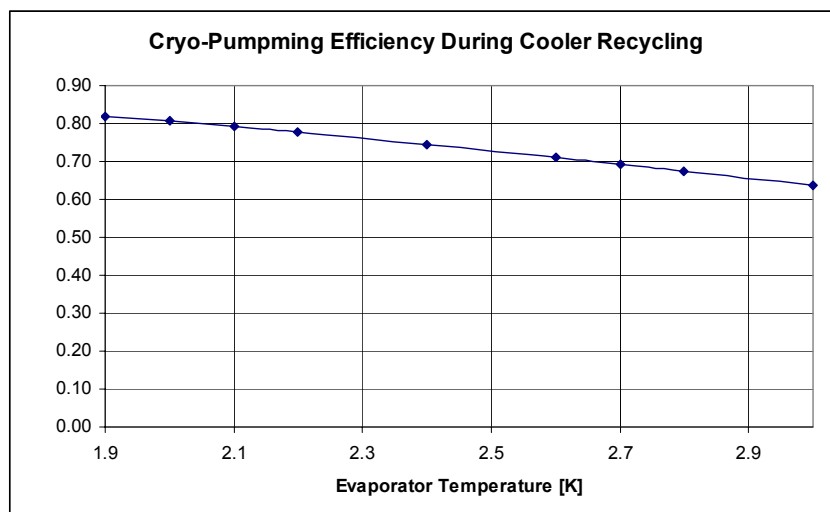

Figure 3.2-2 - Typical profile of cryo-pumping efficiency versus evaporator temperature [AD1].

3.2.3 Cooler Operation Performance Design Drivers

During operation, the cooler hold time and cold tip temperature is driven by:

- Its evaporator's total load [DD3], which depends on cooler internal parasitic load as well as the external load from the 300-mK detector assembly.

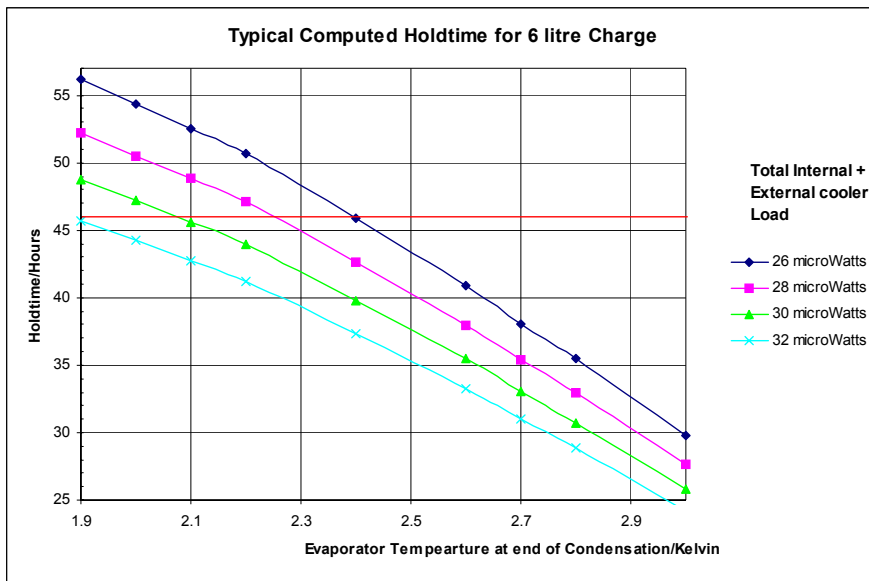

Figure 3.2-3 – Cooler hold time versus overall recycling efficiency and evaporator total load [AD1].

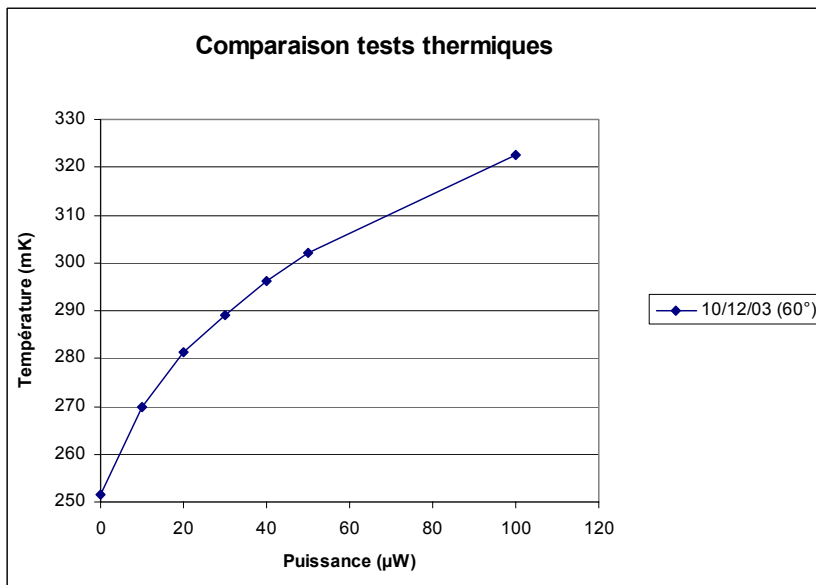



Figure 3.2-4 – Cooler Cold Tip Temperature versus External Load [AD2]

	SPIRE CRYOGENIC THERMAL DESIGN REQUIREMENTS	SPIRE-RAL-PJR-002075 Date: 13-Jan-06 Issue: Issue 1
---	--	---

The figure 3.2.3 describes the cooler hold time performances for a given total load on the evaporator as well as the overall recycling efficiency (the latest given in the graph as a function of the evaporator temperature at the end of the condensation period). A red line has been drawn to indicate the region in which the cooler should be operated in order to achieve the required 46-hour hold time.

The figure 3.2.4 describes recent test results measured by CEA [AD2] with the SPIRE CQM cooler. For this test, an external known load was applied to the evaporator cold tip and its temperature measured. It can be observed that the temperature of the cooler's evaporator cold tip varies as a function of the external applied load. Note 1 and 2 below provide additional information about the interpretation of the results presented in figure 3.2.4.

Note 1: When no external load is applied, the evaporator only sees its internal parasitic load. The temperature of the cold tip can in that case, be used as an indication of how much parasitic the evaporator sees.

Note 2: Care must be taken when using these results to evaluate the SPIRE cooler performances. For these cases, a Level-0 temperature of $\sim 1.6\text{K}$ and a level-1 temperature of $\sim 2\text{K}$ were used, indicating a cooler internal parasitic load of $\sim 8\mu\text{W}$. In flight, the interface temperatures are more likely to be around 1.7K and 4K for the Level-0 and Level-1 respectively.

	SPIRE CRYOGENIC THERMAL DESIGN REQUIREMENTS	SPIRE-RAL-PJR-002075 Date: 13-Jan-06 Issue: Issue 1
---	--	--

4. SPIRE Thermal Requirement Organisation

In the following sections 6 to 10, a detailed statement of the thermal requirements applicable to the various SPIRE subsystems is given. All requirements are defined either as:

- **A High-Level Thermal Requirement:** requirements originally coming from a specification document.
- **A Derived Thermal Requirement:** new or updated high-level requirements necessary to ensure that the instrument will be performing as required. Those evolving requirements results from detailed sensitivity analyses or thermal testing performed on the instrument hardware and can be traced via thermal analysis or test reports.

The interface temperature and load requirements with the Herschel cryostat are described first as top-level requirements. Then all SPIRE thermal requirements are described subsequently, organised by temperature levels first, and then gathered in the subsystem group they apply to. An overview of the report architecture is given below:

- SPIRE Interface temperature and load requirements with the Herschel cryostat
- SPIRE 300-mK Level Thermal Requirements
 - BDA and PTC Subsystem
 - 300-mK strap assembly Subsystem
 - Sorption Cooler subsystem
- SPIRE Level-0 Thermal Requirements
 - Level-0 Evaporator Strap Subsystem
 - Level-0 Pump Strap Subsystem
 - Level-0 Enclosure Strap Subsystem
- SPIRE Level-1 Thermal Requirements
 - Mechanism Internal Power Dissipation
 - FPU feet
- SPIRE Level-2/3 Thermal Requirements
 - JFET Isolation Supports
 - JFET internal Power Dissipation

Figure 5 - SPIRE Thermal Requirement Organisation

5. SPIRE Interfaces with HERSCHEL Thermal Requirements

5.1 Overview

The picture 5.1.1 below provides a description of the thermal interface locations of SPIRE with the Herschel cryostat.

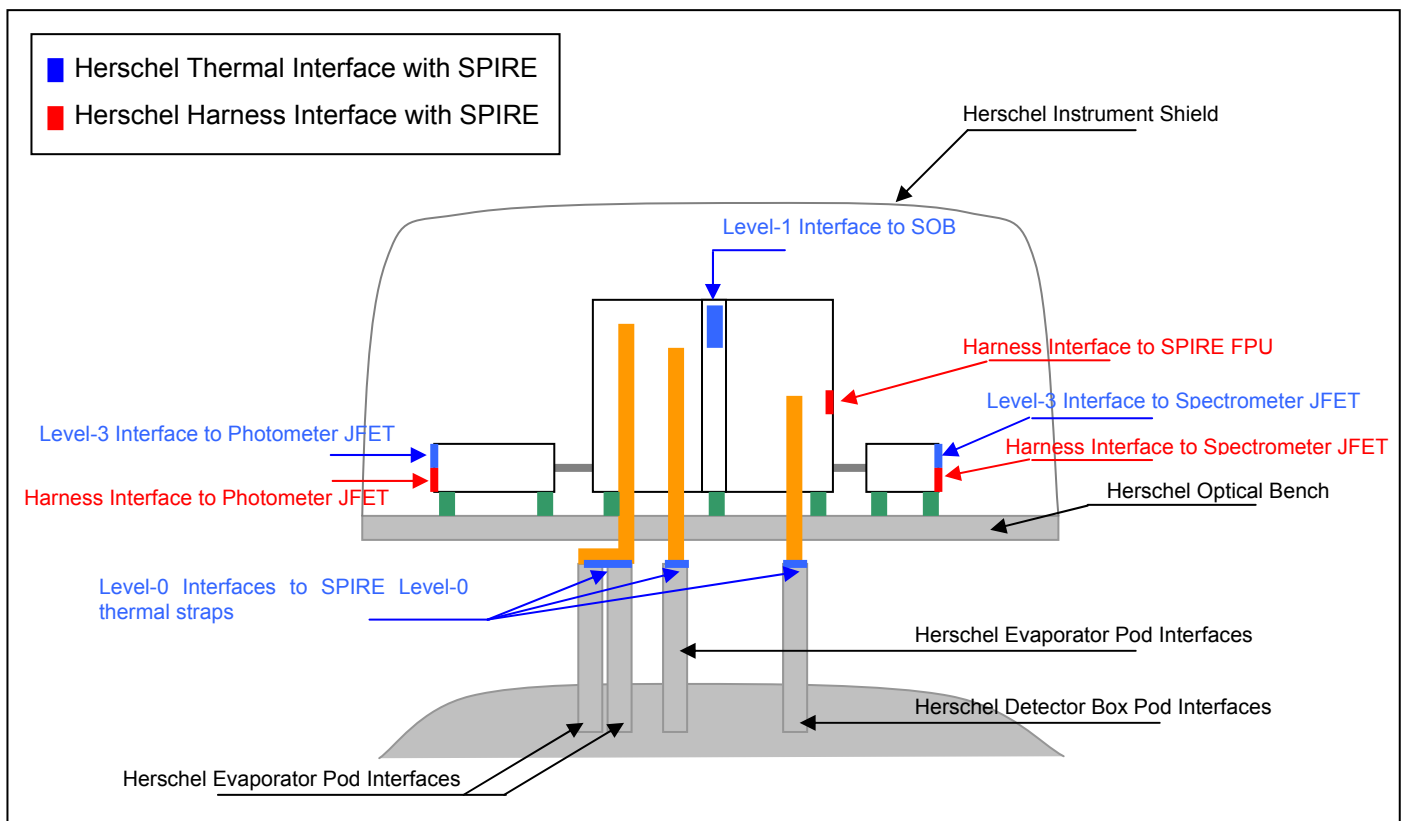

Figure 5.1-1 - HERSCHEL Cryostat / SPIRE Instrument Interfaces Definition

Stringent specifications are placed on the allowable heat loads at the various Herschel interfaces, for two reasons:

- To maximize the Herschel cryostat mission life,
- To guarantee SPIRE with the interface temperatures as described in Table 5.2.1 on next page.

5.2 HERSCHEL Interfaces Thermal Requirements

<i>In-Orbit Thermal Requirements</i> ³			
<i>SPIRE FPU thermal IF</i>	<i>Maximum I/F Temperature at Max Heat Load</i>		<i>Cooler State</i>
	<i>Requirements</i>	<i>Goals</i>	
Level 0 – Detector Box	2 K @ 4 mW	1.71K @ 1 mW	Operating
Level 0 – Cooler Pump	2 K @ 2 mW	2 K @ 2 mW	Operating
	10 K @ 500 mW peak	10 K @ 500 mW	Recycling
Level 0 – Cooler Evaporator	1.85 K @ 15 mW	1.75 K @ 15 mW	Recycling
Level 1	5.5 K @ 15 mW	3.7 K @ 13 mW	Operating
Level 2	12 K @ no load	8 K @ no load	Operating
Level 3 – Photometer	15 K @ 50 mW	15 K @ 50 mW	Operating
Level 3 – Spectrometer	15 K @ 25 mW	15 K @ 25 mW	Operating
Instrument Shield	16 K	16 K	Operating

Table 5.2-1 - HERSCHEL Interfaces Thermal Requirements [Section 5.7.1.3 - RD8]

In table 5.2.1, the “Requirements” column describes the agreed temperatures that the Herschel cryostat shall provide at the various SPIRE interfaces for the stated maximum heat loads.

Please note that although those requirements have been agreed by both parties, only the interface temperatures described in the “goals” section would allow SPIRE to meet its 46-hour hold time requirement. With interface temperatures as described in the “requirements” section, the estimated cooler hold time would only reach around 27 hours [AD5].

Therefore, in addition to those requirements, it has been agreed by both parties that Astrium should demonstrated by analysis that the Herschel cryostat will also be able to provide interface temperatures as those described in the “Goals” column.

³ Assuming a ²He tank temperature of 1.7 K.

6. SPIRE 300-mK Level Thermal Design Requirements

6.1 Overview

The 300mK Level of the SPIRE instrument consists of the following components:

- Five Bolometers Detector Arrays, also called BDAs, mounted off two Level-0 photometer and spectrometer enclosures at $\sim 1.7\text{K}$,
- Two high conductance copper strap assembly, also called 300-mK Busbar, which connect the cooler cold tip to each BDA thermal interface,
- The sorption cooler which provide a cold tip heat sink operating at $\sim 290\text{mK}$ for ~ 46 hours.

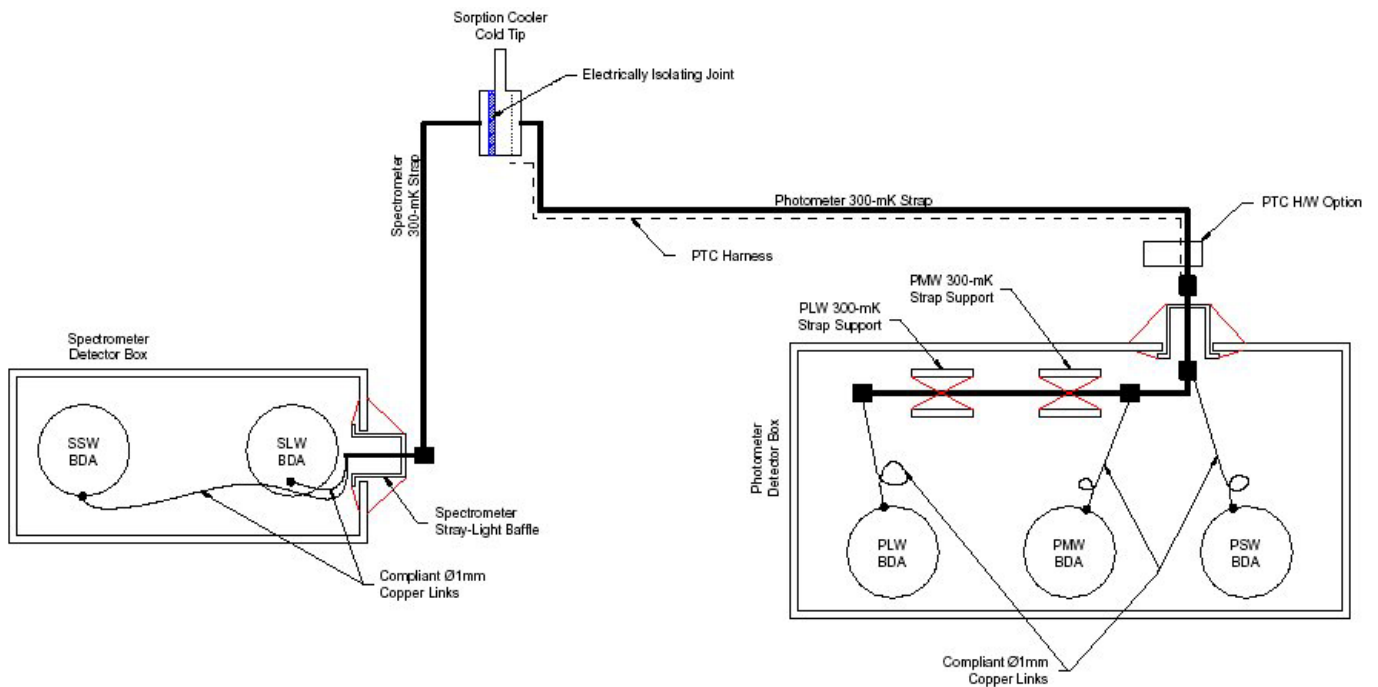



Figure 6.1-1 - SPIRE 300-mK Assembly Overview

	SPIRE CRYOGENIC THERMAL DESIGN REQUIREMENTS	SPIRE-RAL-PJR-002075 Date: 13-Jan-06 Issue: Issue 1
---	--	--

6.2 BDA Detectors and PTC Control Hardware

6.2.1 High Level Thermal Requirements

Requirement	Description	Value	Comments	Reference
BDA-TEC-01	The BDA shall accommodate a defined mechanical interface to the 2K structure.	-	-	
BDA-TEC-02	The BDA shall provide an attachment point and/or a thermal interconnect to a 300mK thermal strap.	-	-	
BDA-TEC-06	Total power load on the 300mK cooler from the five BDAs (from Kevlar cords and Kapton harnesses).	Min performance <15 μ W Design value < 8 μ W	This assumes the focal plane mount is held at 1.7 K.	IRD-DETP-R13 IRD-DETS-R14
BDA-TEC-07	Power allocated for temperature control of the 3 He stage (PTC)	Reqd < 2 μ W	-	-
BDA-HCO-01	Design values of detector performance requires a temperature at the point of contact to the BDA	Reqd < 310mK Goal < 300mK	-	IRD-COOL-R01
BDA-HCO-02	Design values of detector performance require temperature stability at the point of thermal control (near the evaporator).	10 μ K/ $\sqrt{\text{Hz}}$ from 0.1-10Hz	This assumes that the BDA acts as a low-pass thermal filter.	IRD-COOL-R05
BDA-HCO-03	Maximum allowed thermal drift at the point of thermal control (near the evaporator)	< 0.1mK/hr	-	IRD-COOL-R04

Table 6.2-1 – BDA Detectors and PTC High Level Requirements [RD1]

Note: The performance of the 3 He cooler will be measured with the detectors during CQM-level testing. If the thermal performances are not satisfactory, temperature control of the evaporator stage must be implemented on the PFM and FS instrument models [RD1]. The hardware to do this will be implemented on the Proto-Flight Model (PFM).

	SPIRE CRYOGENIC THERMAL DESIGN REQUIREMENTS	SPIRE-RAL-PJR-002075 Date: 13-Jan-06 Issue: Issue 1
---	--	--

6.2.2 Derived Thermal Requirements

Following a sensitivity analysis [AD5], a new goal has been set for the maximum allowable PTC power dissipation (in the form of an energy requirement) to ensure the cooler will achieve its 46-hour hold time.

Requirement	Description	Value	Comments	Reference
<i>Req-SP-01</i>	Maximum Energy available for PTC and active control of BDAs temperature	Goal < 0.16J	Goal based on a maximum continuous power dissipation of 1μW for 46 hrs	AD5

Table 6.2-2 - PTC Derived Thermal Requirement

Note 1: The definition of maximum power dissipation requirement for the PTC has been expressed in terms of an energy requirement, as it appears to be more appropriate. This means that larger peaks of power dissipation could be used if necessary for a shorter period of time as long as the total energy going into the cooler evaporator doesn't exceed 0.16 J per 46 hr operation period.

Note 2: The PTC is only used in photometer mode.

	SPIRE CRYOGENIC THERMAL DESIGN REQUIREMENTS	SPIRE-RAL-PJR-002075 Date: 13-Jan-06 Issue: Issue 1
---	--	--

6.3 300-mK Busbar System

6.3.1 High Level Thermal Requirement

Requirement	Description	Value	Comments	Reference
STRAP-Req-01	Maximum Temperature drop along 300mK Busbar System – from the cooler cold tip to each BDA assembly Thermal Interface.	Req _t < 20mK	No temperature boundaries specified	IRD-COOL-R03
STRAP-Req-02	Maximum heat leak through 300mK system Kevlar supports	2 μW	No temperature boundaries specified	-
STRAP-Req-03	Maximum heat leak through PTC Harness	Req _t < 0.2 μW	No temperature boundaries specified	-

Table 6.3-1 – 300-mK Busbar High Level Thermal Requirements [RD2]

6.3.2 Derived Thermal Requirement

Requirement	Description	Value	Comments	Reference
Req_t-SP-02	Goal Temperature at each of the Busbar BDA thermal interfaces	Req _t < 310mK Goal < 300mK	-	IRD-COOL-R01
Req_t-SP-03	Goal Temperature drop along 300-mK Busbar – from cooler cold tip to each BDA thermal interface	Goal < 10mK	With cooler tip at 290mK for a 10μW heat lift.	IRD-COOL-R01

Table 6.3-2 – 300-mK Busbar Derived Thermal Requirement

It can be seen that if the requirement STRAP-Req_t-01 for the Busbar maximum temperature drop were to be used, it would not allow the design to meet the goal requirement for the BDA interface temperatures (see table 6.3.3). A new derived requirement “Req_t-SP-03” had to be set for the 300-mK Busbar system in order to achieve both required BDA interface temperatures.

Cooler cold Tip temperature	BDA strap interface temperatures	
	With 20-mK Busbar Requirement	BDA Goal Requirement
290mK	310mK	300mK

Table 6.3-3 - BDA strap interface temperatures Analysis

The 300-mK Busbar shall be designed to meet the most demanding requirement, which is to achieve a maximum of 10mK temperature drop (goal requirement) from the cooler cold tip to each BDA thermal interface, and this, for the maximum load expected to flow along the Busbar. The different sections of the Busbar see different amounts of parasitic load however. In the following tables and figure, a description of the heat load flowing on each section of the 300-mK Busbar is given. This should be used, as a reference when designing each Busbar section in order to ensure that the 10mK temperature drop will be met for all five thermal interfaces.

	SPIRE CRYOGENIC THERMAL DESIGN REQUIREMENTS	SPIRE-RAL-PJR-002075 Date: 13-Jan-06 Issue: Issue 1
---	--	---

The amounts of parasitic load flowing along the various sections of the Busbar have been predicted based on the maximum parasitic load allocated for all five detectors. In addition, the Kevlar parasitic load has been assumed to be identical for all detectors.

Subsystem Components	Maximum Load (μW)
Load / BDA Kevlar Support	1.5
Load / BDA Kapton Harness	0.5
<i>PLW 2 Kapton Harness</i>	1
<i>PMW 4 Kapton Harness</i>	2
<i>PSW 6 Kapton Harness</i>	3
<i>SLW 1 Kapton Harness</i>	0.5
<i>SSW 2 Kapton Harness</i>	1
PTC Harness	0.2
PTC Power Dissipation	2
Load / Busbar Kevlar Supports	0.5

Table 6.3-4 – Nominal Load for various 300-mK subsystems

Busbar Section	Description	PLW	Busbar Supports		PMW	PSW	Feedthru Support	PTC Harness	PTC Heater	Total Load (μW)
P1	Strap from cooler cold tip to photometer Feedthru	X	X	X	X	X	X	X	X	14.2
P2	Photometer Feedthru	X	X	X	X	X	X			12
PC1	PSW Compliant Link					X				4.5
P3	Busbar Section 1	X	X	X	X					7
PC2	PMW Compliant Link				X					3.5
P4	Busbar Section 2	X	X	X						3.5
P5	Busbar Section 2	X								2.5
PC3	PLW Compliant Link	X								2.5

Table 6.3-5 - Nominal Loads seen on the various section of the 300-mK Photometer Busbar

Busbar Section	Description	SLW	SSW	Feedthru Support	Total Load (μW)
S1	Strap from cooler cold tip to spectrometer Feedthru	X	X	X	5
S2	Spectrometer Feedthru	X	X	X	5
SC1	SSW Compliant Link		X		2.5
SC2	SLW Compliant Link	X			2

Table 6.3-6 - Nominal Loads seen on the various section of the 300-mK Spectrometer Busbar



SPIRE CRYOGENIC THERMAL DESIGN REQUIREMENTS

SPIRE-RAL-PJR-002075
Date: 13-Jan-06
Issue: Issue 1

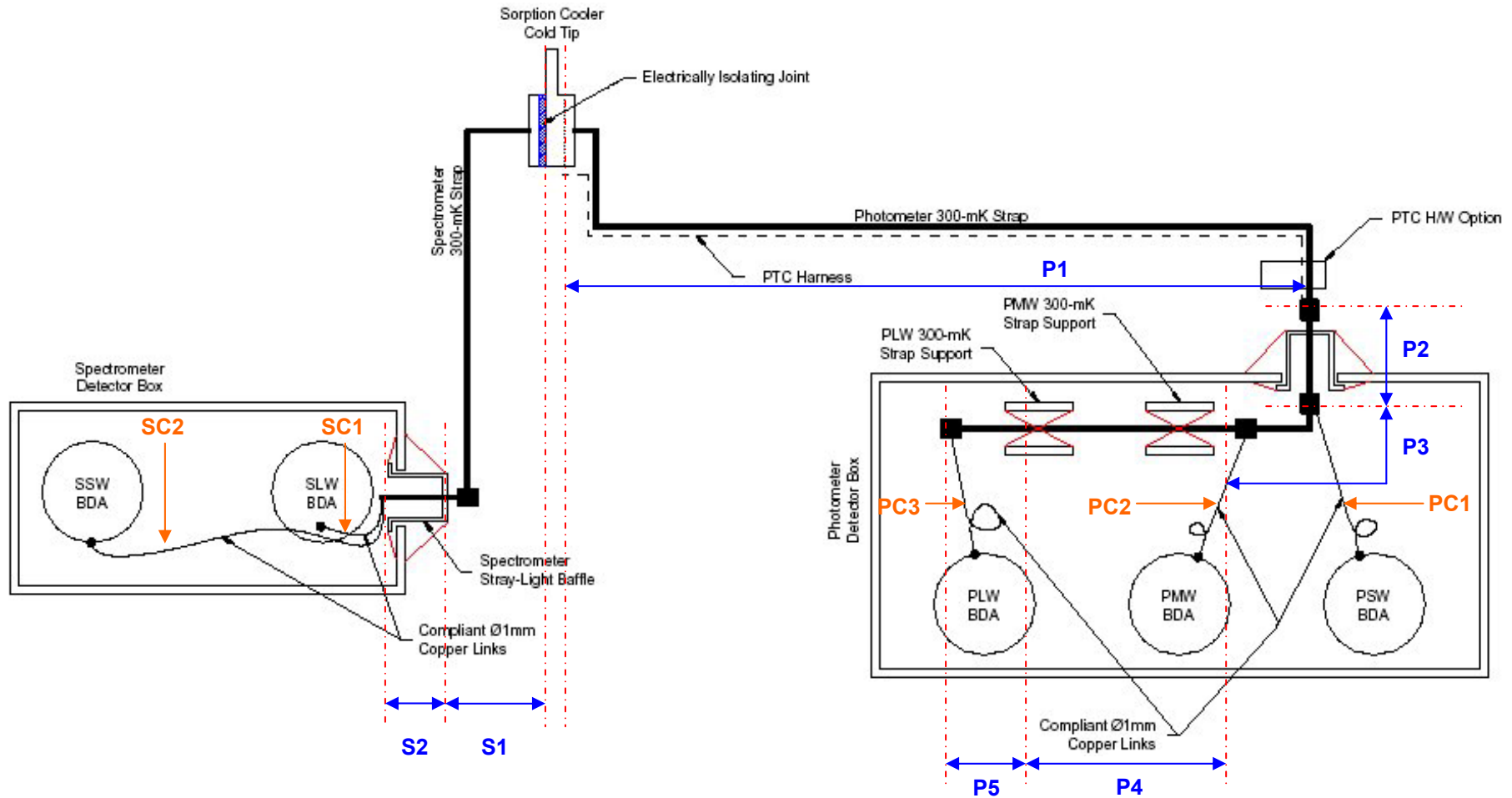



Figure 6.3-1 – Applicable load for given sections of the 300-mK Busbar

	SPIRE CRYOGENIC THERMAL DESIGN REQUIREMENTS	SPIRE-RAL-PJR-002075 Date: 13-Jan-06 Issue: Issue 1
---	--	--

6.4 ³He Sorption Cooler

6.4.1 High Level Thermal Requirement

Requirement	Description	Value	Comments	Reference
Req-Cooler	Nominal Cooler operation conditions	1.7K Heat Sink 4K Environment	-	-
	Net heat lift at 290mK	10 μ W	In nominal conditions	IRD-COOL-R07
	Minimum total amount of cold joules produced by cooler	5 J	-	IRD-COOL-R08
	Maximum time allocated for recycling	2 hrs	-	IRD-COOL-R09
	Maximum Energy dissipated by cycle due to cooler operation	860 J	-	IRD-COOL-R11 IRD-COOL-R12
	Additional contribution from the 1.7-4K environment	< 0.6 mW	-	IRD-COOL-R13

Table 6.4-1 – Sorption Cooler High Level Requirements [RD3]

6.4.2 Derived Thermal Requirement

Based on a 46-hour hold time, the 5J of cooler energy represents an average nominal load on the cooler evaporator of 30 μ W. This value has been used as an input to the thermal design in order to control the cooler heat load budget, and has therefore been defined in table 6.4.2 as the requirement “Req-SP-21”.

Requirement	Description	Value	Comments	Reference
Req-SP-21	Maximum average total load on cooler evaporator during 46hr nominal operation	30 μ W	Based on a total cooler energy of 5J	Req-Cooler
Req-SP-04	Maximum cooler internal parasitic Load Use 0.29mm Kevlar cords at evaporator.	12 μ W	As an objective	AD4
Req-SP-05	Maximum Load at Herschel L0 Evaporator Pod during recycling	15mW	To ensure a 1.75 K pod interface Temperature	RD8 Section 5.7.1.3

Table 6.4-2 – Sorption Cooler Derived Thermal Requirements

As described above, the maximum average total load on the cooler evaporator during nominal operation must not exceed 30 μ W to achieve the required cooler hold time. The evaporator total load is driven by the cooler own parasitic load and by the 300-mK Busbar parasitic load. It is therefore important to define what is the maximum load allocation for each of these subsystems. Table 6.4.3 below describes the maximum load for which the 300-mK sub-systems are being designed.

300-mK Sub-System Load Breakdown		References
BDAs [x5]	15 μ W	BDA-TEC-06
PTC Power Dissipation	1 μ W	Req-SP-01
300-mK Busbar	2 μ W	STRAP-Req-02
PTC Harness	< 0.2 μ W	STRAP-Req-03
Total	18.2 μ W	-

Table 6.4-3 - 300-mK Sub-system Parasitic Load Breakdown

	SPIRE CRYOGENIC THERMAL DESIGN REQUIREMENTS	SPIRE-RAL-PJR-002075 Date: 13-Jan-06 Issue: Issue 1
---	--	--

From the table above, it can be deduced that the maximum parasitic load internal to the cooler shall be within $12 \mu\text{W}$ in order for the total evaporator load to not exceed $30\mu\text{W}$. This statement has been defined as the derived requirement "Reqt-SP-04" in table 6.4.2 on previous page.

Note: An action has already been taken in the past to reduce the cooler internal parasitic loads by reducing the Kevlar cords diameter from 0.5mm to 0.29mm [AD4].

A final derived requirement for the cooler is coming the high-level requirements agreed between the Herschel cryostat and the SPIRE instrument, to have a maximum load of 15mW flowing on the evaporator strap during the cooler recycling, in order to obtain the required 1.75K interface temperature at the evaporator pod. This high-level requirement has been repeated here as a cooler derived requirement "Reqt-SP-05" as it drives the cooler internal design and operation during recycling.

7. SPIRE Level-0 Thermal Design Requirements

7.1 Overview

The SPIRE Level-0 operates nominally at 1.7K and consists of the following sub-systems:

- A set of two thermal straps connecting the cooler pump and evaporator heat switches interfaces to dedicated pods of the Herschel cryostat:
 - The Level-0 Evaporator Strap,
 - The Level-0 Pump Strap.

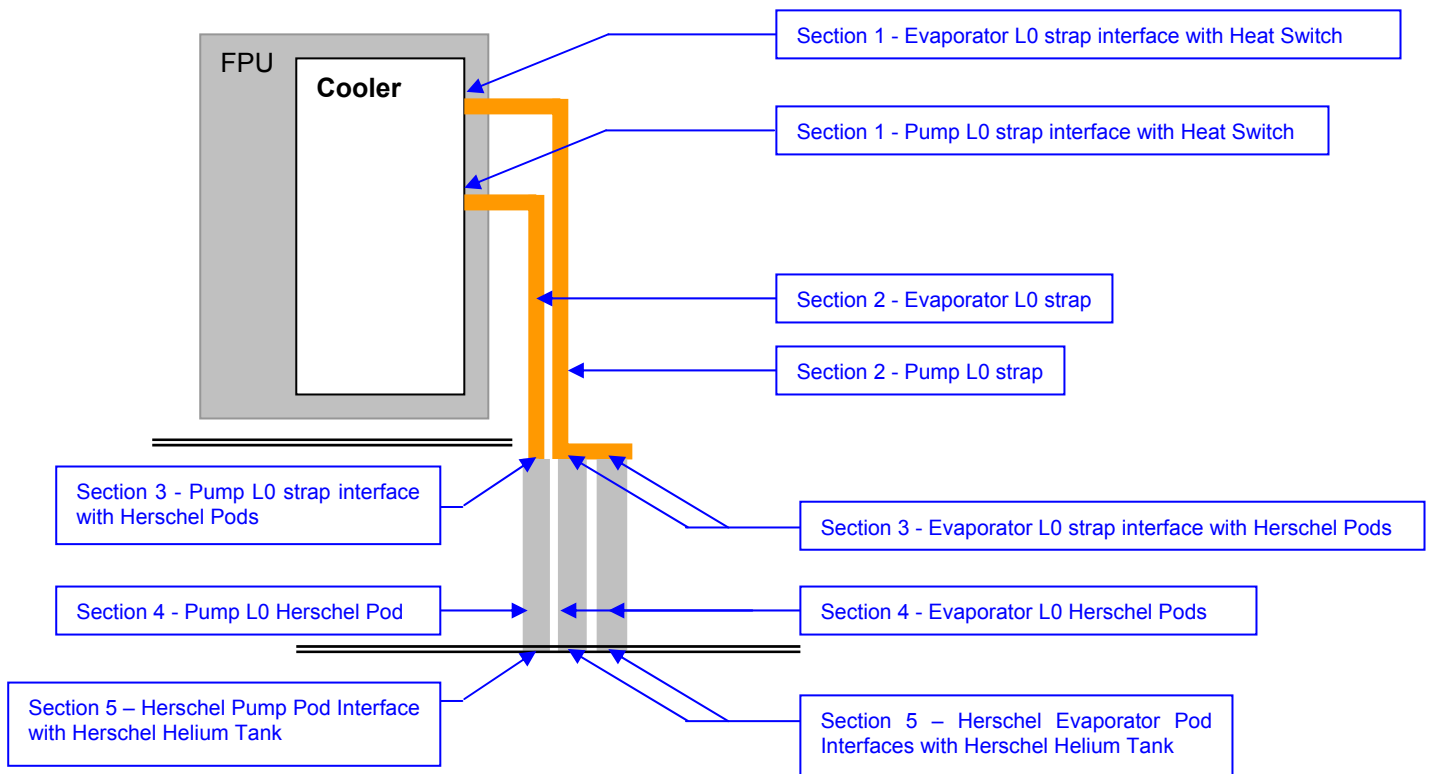

Figure 7.1-1 – SPIRE and Herschel Level-0 Straps/Pods interface Description

- The photometer and spectrometer enclosures,
 - Both enclosures are mounted on the SOB on low conductance supports,
 - A low conductance F-harness connects the FPU to each L0 enclosures,
 - An interbox strap thermally couples the photometer enclosure to the spectrometer enclosure (internal to the SPIRE FPU),
 - An external strap thermally couples the spectrometer enclosure to a dedicated Level-0 pod of the Herschel cryostat.

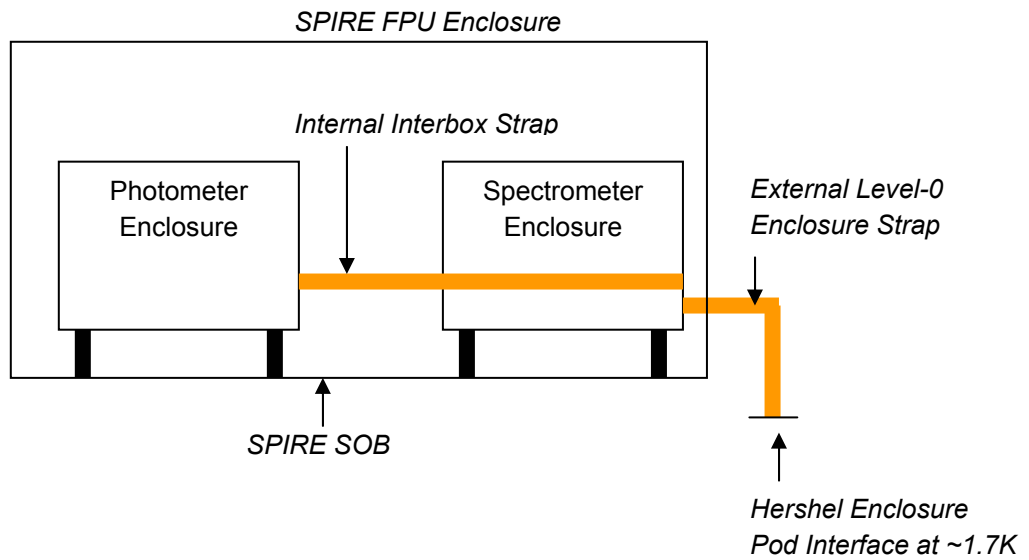



Figure 7.1-2 – Level-0 Spectrometer and Photometer Enclosures Strap Assembly

The following sections describe in more details the thermal requirements applicable to the various Level-0 sub-systems.

	SPIRE CRYOGENIC THERMAL DESIGN REQUIREMENTS	SPIRE-RAL-PJR-002075 Date: 13-Jan-06 Issue: Issue 1
---	--	--

7.2 Level-0 Evaporator Strap

7.2.1 High Level Thermal Requirement

Requirement	Description	Value	Comments
RD8 Section 5.7.1.3	Maximum Load at Herschel L0 Evaporator Pod during recycling	15mW	For a 1.75 K pod interface Temperature

Table 7.2-1 – Level-0 Evaporator Strap High-Level Requirement

The only main high-level requirement is coming from the instrument interface specification document RD8. Although this requirement is applicable to the Level-0 evaporator strap itself, the cooler internal construction will be the main driver for this load.

This evaporator strap however is driving the cooler recycling performances, as the evaporator temperature at the end of the condensation phase is directly dependent on how well this strap performs. It has been advised by CEA that the overall conductance of the thermal link connecting the evaporator heat switch interface to the Level-0 Helium heat sink should be no less than 0.1 W/K during recycling.

In reality, this link includes the following components (please see figure 7.1.1 for corresponding details):

- Section 1: SPIRE Level-0 evaporator strap interface with the cooler evaporator heat switch,
- Section 2: SPIRE Level-0 evaporator strap,
- Section 3: The Level-0 strap interfaces (two of them) with the Herschel Level-0 pod,
- Section 4: The Evaporator Level-0 pods (one nominal and one open pod),
- Section 5: The Evaporator Level-0 pod interfaces (two of them) with the ²He Herschel cryostat.

Note: According to the requirement described above, it can be concluded that the calculated Herschel cryostat pod overall conductance (which includes the sections 3, 4 and 5) will be ~ 0.3 W/K⁴.

7.2.2 Derived Thermal Requirement

According to Figure 3.2.3, it can be seen that to achieve a 46-hour hold time with a nominal evaporator total load of 30μW (or 5J over 46 hours), the evaporator temperature at the end of the condensation phase during the cooler recycling must be less than 2K. This statement has been summarised as the derived requirement “Req-SP-06” in table 7.2.2.

The following thermal conditions must be taken into account when designing the Level-0 evaporator strap:

- A 1.75K interface temperature shall be provided at the Herschel evaporator pod, assuming a maximum heat load of 15mW is flowing along the Level-0 evaporator strap [RD8],
- A 0.15K internal temperature drop has been assumed to take place inside the cooler (from the evaporator heat switch to the evaporator wall [AD6]).

⁴ Based on a Herschel ²He temperature of 1.7K.

	SPIRE CRYOGENIC THERMAL DESIGN REQUIREMENTS	SPIRE-RAL-PJR-002075 Date: 13-Jan-06 Issue: Issue 1
---	--	--

In order to achieve 2K at the evaporator, the Level-0 Evaporator Strap shall be sized so that the maximum temperature drop during recycling along the strap shall be no more than 0.1 K for 15 mW (“Req-SP-07”).

Requirement	Description	Value	Comments	Reference
Req-SP-06	Maximum Evaporator Temperature at end of condensation phase	2K	During recycling	Figure 3.2.3
Req-SP-07	Maximum Evaporator Temperature drop from Herschel Interface to cooler Interface	0.1K for 15mW Or 0.15 W/K at 1.7K	During recycling Assuming a 0.15K drop internal to the cooler	Req-SP-06 RD8 Section 5.7.1.3 [Goals]

Table 7.2-2 – Level-0 Evaporator Strap Derived Thermal Requirements

Note 1: The 0.15W/K stated conductance for the L0 evaporator strap:

- Must include the interface at the cooler heat switch (section 1),
- Does not include the interface at the Herschel Pod (section 3).

Note 2: A Herschel pod overall conductance of 0.3 W/K in series with the Level-0 evaporator strap overall conductance of 0.15 W/K provide a thermal link of 0.1W/K, as suggested by CEA.

No specific requirement regarding the maximum load has been defined to date on the evaporator strap during nominal instrument operation. However, the following points should be kept in mind:

- The cooler internal parasitic loads introduced via the evaporator heat switch and the shunt strap are dependent on the temperature at the evaporator heat switch – the lower this temperature, the lower the parasitic.
- To keep the temperature at the Herschel Evaporator Pod interface as close as possible to 1.7K during operation, the load on the Level 0 evaporator strap must be kept to a minimum during operation.

7.3 Level-0 Pump Strap

7.3.1 High Level Thermal Requirement

The only main high-level requirements applicable to the L0 pump strap are coming from the instrument interface specification document RD8.

Requirement	Description	Value	Comments
RD8 Section 5.7.1.3	Maximum Load at Herschel L0 Pump Pod during operation	2mW	For a pod interface Temperature of 2K
	Maximum Load at Herschel L0 Pump Pod during recycling	500mW	For a pod interface Temperature of 10K

Table 7.3-1 - Level-0 Pump strap High-Level Requirements

It has been advised by CEA that the overall conductance of the thermal link connecting the pump heat switch interface to the Level-0 Helium heat sink should be around 0.05 W/K during recycling.

In reality, this link includes the following components (please see figure 7.1.1 for corresponding details):

- Section 1: SPIRE Level-0 pump strap interface with the cooler pump heat switch,
- Section 2: SPIRE Level-0 pump strap,
- Section 3: The Level-0 strap interface with the Herschel Level-0 pod,
- Section 4: The pump Level-0 pod,
- Section 5: The pump Level-0 pod interface with the ²He Herschel cryostat.

Note: According to the requirement described above for recycling, it can be concluded that the Herschel cryostat pod overall conductance (which includes the sections 3, 4 and 5) will be about 0.06 W/K ⁵.

7.3.2 Derived Thermal Requirement

To achieve the 0.05 W/K conductance suggested by CEA, the Level 0 Pump Strap Conductance should be no less than 0.15 W/K as defined by the derived requirement "Req-SP-08".

Requirement	Description	Value	Comments	Reference
Req-SP-08	Minimum Level 0 Pump Strap Conductance	0.15 W/K	At 1.7K.	-

Table 7.3-2 - Level-0 Pump Strap Derived Requirement

Note 1: Please note that the 0.15 W/K conductance stated for the L0 pump strap:

- Must include the interface at the cooler heat switch (section 1),
- Does not include the interface at the Herschel Pod (section 3).

⁵ Based on a Herschel ²He temperature of 1.7K.

	SPIRE CRYOGENIC THERMAL DESIGN REQUIREMENTS	SPIRE-RAL-PJR-002075 Date: 13-Jan-06 Issue: Issue 1
---	--	--

Note 2: A Herschel pod overall conductance of 0.06 W/K in series with the Level-0 pump strap overall conductance of 0.15 W/K provide a thermal link of 0.043 W/K, close enough to the 0.05 W/K suggested by CEA.

Although the temperature of the pump heat switch interface doesn't affect the cooler parasitic or hold time directly, it is important to maintain the load along the Level-0 strap within the 2mW requirement as to maximise the Herschel cryostat mission lifetime.

The load observed on the L0 Pump strap consists of:

- Cooler heat of adsorption which ranges within 48 to 50 times the evaporator total load according to the SPIRE Cooler CQM test results,
- Pump Heat Switch Heater Power dissipation,
- Pump Heat Switch titanium support heat leak from the cooler Level-1 enclosure,
- Level-0 Pump strap standoffs heat leak from the FPU.

7.4 Level-0 Enclosures Strap Sub-system

7.4.1 High Level Thermal Requirement

Requirement	Description	Value	Comments
RD8 Section 5.7.1.3 [Goal]	Maximum Load at Herschel L0 Enclosures Pod	1 mW	For a pod interface Temperature of 1.71 K

Table 7.4-1 - Level-0 Enclosures Straps High-Level Requirement

The photometer and the spectrometer Level-0 enclosures provide a conductive and radiative interface to the five detector BDAs at approximately 1.7K. The temperature of these two enclosures is of upmost importance as it drives the amount of parasitic load going into the 300mK system (via the five BDAs and the Busbar assembly), and therefore participates to the total load of the cooler. This effectively has a direct impact on the cooler hold time and the evaporator cold tip temperature.

7.4.2 Derived Thermal Requirement

There is a need for these two enclosures to run at temperatures as close to 1.7K as possible to minimise the parasitic loads into the 300-mK system. To do so, the photometer and spectrometer enclosures are connected to the Herschel Cryostat Level-0 pod interface (running at 1.71K according to the goal requirements) via an arrangement of straps designed to minimise the temperature drop from the to the enclosures.

The figure 7.4.1 resulting from a sensitivity analysis [AD5] has shown that in order to achieve a 46-hour hold time, the Level-0 enclosures temperatures should not exceed 1.74K. This has been defined as a derived requirement "Reqd-SP-09" applicable to both Level-0 enclosures, as described in table 7.4.2.

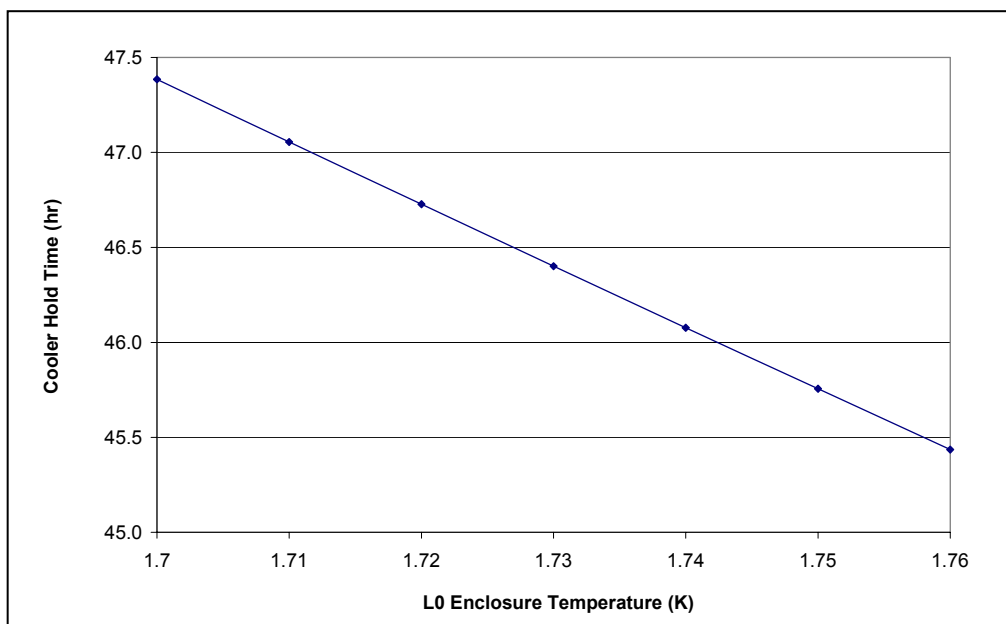



Figure 7.4-1 – Level-0 Enclosure Temperature versus Cooler Hold Time [AD5]

	SPIRE CRYOGENIC THERMAL DESIGN REQUIREMENTS	SPIRE-RAL-PJR-002075 Date: 13-Jan-06 Issue: Issue 1
---	--	--

Although the spectrometer enclosure is directly connected to the Herschel Level-0 pod via the external strap, the photometer enclosure must first be connected to the spectrometer enclosure through the interbox strap. In order to achieve 1.74K at the photometer enclosure with an Herschel interface temperature of 1.71K, both the internal interbox and external Level-0 enclosure straps shall be sized to provide a maximum temperature drop during operation of no more than 0.03 K for a maximum load of 1 mW as defined in the derived requirement "Req-SP-10".

Note: Please note that thermal gradient within the Level-0 enclosures should also be kept to a minimum value.

Requirement	Description	Value	Comments	Reference
Req-SP-09	Maximum L0 Enclosures Temperature	1.74 K	During operation	AD5
Req-SP-10	Maximum Temperature drop between the Herschel L0 enclosure interface and the thermal strap interface at the photometer enclosure.	0.03 K	For a maximum load of 1mW during operation	AD5 / RD8
Req-SP-11	Minimum External Level 0 Enclosure Strap Conductance	0.15 W/K	During operation at 1.7K	AD4
Req-SP-12	Minimum Internal interbox Strap Conductance	0.05 W/K	During operation at 1.7K	AD4
Req-SP-13	Gradient within the photometer Enclosure	< 0.01K	As objective, during operation at 1.7K.	-
Req-SP-14	Maximum Level-0 spectrometer A-Frames conductance	1.6×10^{-5} W/K	Between 1.73K and 5K Per A-frame [3]	AD4
Req-SP-15	Maximum Level-0 photometer A-Frames conductance	3.7×10^{-5} W/K	Between 1.8K and 5K Per A-frame [2]	AD4
Req-SP-16	Maximum Level-0 photometer cone conductance	7.2×10^{-5} W/K	Between 1.85K and 5.1K Per Cone [1]	AD4
Req-SP-21	Maximum L0 photometer and spectrometer enclosures emissivity	0.2	-	IRD-STRS-R04 IRD-STRP-R04
Req-SP-22	Not Used.			

Table 7.4-2 - Level-0 Enclosures Straps Derived Requirements

As described in the high-level requirement, the maximum load on the Level-0 Enclosures strap shall not exceed 1mW. The load observed on the Level-0 Enclosures strap consists of:

- Parasitic Load from the Level-0 Enclosures Strap Standoffs off the FPU,
- Parasitic Load from the Level-0 Enclosure supports off the SOB,
- Parasitic Load from the F-Harness connecting the Level-0 enclosures to the FPU.

Note 1: Please note that the 0.15 W/K conductance stated for the external L0 Enclosure strap:

- Must include the interface at the spectrometer enclosure interface,
- Does not include the interface at the Herschel Pod.

Note 2: The previous Level-0 enclosure support design used to be major contribution in heat leaks into the Level-0 stage. Derived requirements have therefore been defined to limit the maximum allowable conductance of each support and thus minimise the heat leaks into the Level-0 stage.

Note 3: With an external strap conductance of 0.15W/K and an interbox strap conductance of 0.05W/K, the overall thermal path conductance is 0.0375W/K at 1.7K, which for a 1mW maximum heat load will provide a maximum temperature drop of 0.026K.

	SPIRE CRYOGENIC THERMAL DESIGN REQUIREMENTS	SPIRE-RAL-PJR-002075 Date: 13-Jan-06 Issue: Issue 1
---	--	--

8. SPIRE Level-1 Thermal Design Requirements

8.1 Overview

The SPIRE FPU Level-1 structure consists of an Aluminium Alloy 6082 Spire Optical Bench (SOB) with the spectrometer and photometer assemblies mounted on opposite sides. Aluminium covers surround each assembly and are hard bolted to the SOB to form the Focal Plane Unit (FPU). The SOB forms the mechanical interface for the mirrors, mechanisms and the sorption cooler frame. These components are hard bolted to the SOB. The SOB is then connected to the Level-1 ventline of the Herschel cryostat to be cooled down at temperatures around 4-5K.

The key thermal design features of the SPIRE Level-1 stage are as follows:

- Reduced parasitic load from the Level-2 HOB by using three isolating supports for the FPU,
- Low mechanisms internal power dissipation,
- Low conductance F-harnesses connect the FPU to both JFET enclosures,
- Low conductance housekeeping harnesses connect the FPU to the Level-2 HOB,
- The SOB is thermally coupled to the Herschel Level-1 Ventline (at approximately 4K) via two straps provided by the Herschel cryostat.

	SPIRE CRYOGENIC THERMAL DESIGN REQUIREMENTS	SPIRE-RAL-PJR-002075 Date: 13-Jan-06 Issue: Issue 1
---	--	--

8.2 High Level Thermal Requirement

Requirement	Description	Value	Comments	Reference
RD8 Section 5.7.1.3	Maximum Load at Herschel L1 Ventline	13 mW	Goal during operation, for a Level-1 Ventline interface Temperature of 3.7 K	-
IRD-BSMP-R12 [RD6]	Maximum average power dissipation of the BSM Cryogenic Mechanism (BSMm) and the BSM Support Structure (BSMs)	< 4mW	In any operating mode.	-
SMECm_Tm8 [RD7]	SMECm Maximum Power consumption	<= 2.4 mW	Required mean power consumption over the mission.	-
IRD-CALP-R12 [RD4]	Photometer Calibrator maximum power dissipation in the FPU when operating continuously at nominal radiant output	4 mW (requirement) 2 mW (goal)	PCAL will be in the ON condition for only about 5 seconds every hour. Allowing for the maximum dissipation of 4 mW, during this period, the time-averaged dissipation of PCAL will be less than 6μW.	-

Table 8.2-1 - Level-1 FPU High-Level Requirement

The temperature of the Level-1 FPU is the one of the main driver of the instrument overall thermal performances as most of the load going into the Level-0 and the 300-mK stage (or the cooler evaporator) are highly dependent on the SOB/FPU temperature. The main requirement is therefore to have the SPIRE SOB/FPU running as cold as possible and a nominal L1 interface temperature of 3.7K has been agreed as a goal with the Herschel cryostat as described in table 8.2.1.

Note: The larger the load going into the Herschel Level-1 ventline, the warmer the cryostat Level-1 interface will run. The total instrument heat load to the Level-1 ventline must therefore be kept to a minimum and below 13mW.

8.3 Derived Thermal Requirement

The original FPU isolation support design (made of stainless steel) used to be one of the major contribution in heat leaks into the Level-1 Ventline. Derived requirements have therefore been defined to limit the maximum allowable conductance of each support and thus to minimise the heat leaks into the Level-1 Ventline stage. The implementation of these new L1 isolation supports (made of CFRP) also greatly reduces the sensitivity of the Level-1 FPU load to the HOB temperature.

Another important contribution to the L1 heat load is the power dissipation from the instrument calibration sources and mechanisms. In order to control the L1 heat load, a power dissipation budget has been defined for each calibration source and mechanisms as defined from the derived Req-SP-19 and 27 to 31 in table 8.3.1. Please note that the value allocated for each system corresponds to the mean power dissipation over a 46hr operation period for the worse case operating mode.

	SPIRE CRYOGENIC THERMAL DESIGN REQUIREMENTS	SPIRE-RAL-PJR-002075 Date: 13-Jan-06 Issue: Issue 1
---	--	--

Requirement	Description	Value	Comments	Reference
Req-SP-17	Maximum Level-1 A-Frame Supports Conductance	1.14 x 10 ⁻⁴ W/K	Between 10.7K and 5.2K Per A-frame [2]	AD4 IRD-STRC-R14
Req-SP-18	Maximum Level-1 Cone Supports Conductance	2.12 x 10 ⁻⁴ W/K	Between 10.7K and 5.2K Per Cone [1]	AD4 IRD-STRC-R14
Req-SP-19	SCAL Maximum Power Dissipation	2 mW	Mean Power over 46hr operation period	AD4 IRD-CALS-R09
Req-SP-23	Maximum Housekeeping Harness Load from Herschel Cryostat	TBC	Between TBC K and TBC K.	-
Req-SP-24	Maximum L1 FPU enclosure emissivity	0.2	-	IRD-STRC-R05
Req-SP-25	Thermal Stability required at L1 FPU enclosure. Chopping Spectroscopy DS/point sources DS/extended emission	3.6 K/hr 320 K/hr 0.26 K/hr 4e-3 K/hr	-	RD12
Req-SP-26	L1 Isolation Joint Minimum Thermal Conductance	1.5 W/K	Maximum of 0.01K for 15mW	IRD-STRC-R15
Req-SP-27	PCAL Maximum Power Dissipation	0.33 μW	Mean Power over 46hr operation period	IRD-CALP-R12
Req-SP-28	BSM Maximum Power Dissipation	3 mW	Mean Power over 46hr operation period	IRD-BSMP-R12
Req-SP-29	SMEC Actuator Maximum Power Dissipation	2.6 mW	Mean Power over 46hr operation period	IRD-SMEC-R11
Req-SP-30	SMEC Encoder Maximum Power Dissipation	0.5 mW	Mean Power over 46hr operation period	IRD-SMEC-R11
Req-SP-31	SMEC LVDT Maximum Power Dissipation	0.1 mW	Mean Power over 46hr operation period	IRD-SMEC-R11

Table 8.3-1 - Level-1 FPU Derived Requirements

	SPIRE CRYOGENIC THERMAL DESIGN REQUIREMENTS	SPIRE-RAL-PJR-002075 Date: 13-Jan-06 Issue: Issue 1
---	--	--

9. SPIRE Level-2 / Level-3 Thermal Design Requirements

9.1 Overview

The Level-2 consists of the Herschel Optical Bench (HOB) on which the SPIRE FPU and two JFETs enclosures are mounted. The temperature of the HOB has an important impact on the SPIRE Level-1 parasitic loads and every effort must be made to keep the HOB temperature as low as possible. To do so, the Level-3 ventline has been implemented as a part of the Herschel cryostat design to which both JFET enclosures are thermally coupled to heat sink most of the load they will dissipate during operation. This allows lower HOB temperature to be achieved.

9.2 High Level Thermal Requirement

Requirement	Description	Value	Comments	Reference
JFET-FUN-01	The JFET module will mount to the Herschel optical bench, dissipating power at the Level-2 stage of the cryostat.	-	-	N/A – Now hat sunk to a dedicated L3 ventline.
JFET-TEC-05	Maximum allowed total JFET power dissipation for:			IRD-FTB-R05
	Photometer mode	42mW	-	
	Spectrometer mode	14mW	-	
	Design value for JFET module dissipation per 48-channel module.	7 mW	-	
	Thermal dissipation of fully functional CQM JFET units may be as large as 11 mW per module to meet minimum noise performance specification.	-	-	
RD8 Section 5.7.1.3	Maximum Photometer Load into the L3 ventline	50mW	For a 15K interface temperature	
	Maximum Spectrometer Load into the L3 ventline	25mW	For a 15K interface temperature	

Table 9.2-1 – Photometer and Spectrometer JFET High-Level Requirements

9.3 Derived Thermal Requirement

To obtain optimal performances with the Level-3 ventline implementation, both JFET enclosures had now to be isolated as much as possible from the HOB. A derived requirement has therefore been defined for the new support design in the forms of a maximum allowable conductance per JFET enclosure as described in table 9.3.1 with the requirement “Req-SP-20”.

Requirement	Description	Value	Comments	Reference
Req-SP-20	Maximum JFET Support Overall Conductance	Req-SP-20 < 0.005 W/K Goal < 0.002 W/K	Per JFET unit	AD4 RD10-Section 5.7.1.2 IRD-FTB-R11
Req-SP-32	Maximum Cryo-Harness Load from Herschel Cryostat	TBC	Between TBC K and TBC K.	-
Req-SP-33	L3 Isolation Joint Minimum Thermal Conductance	0.138 W/K	-	IRD-FTB-R12 AD8

Table 9.3-1 - Photometer and Spectrometer JFET Derived Requirements