

## SPIRE-RAL-NOT-002028

### Issue 1.0

Douglas Griffin

Monday, 06 September 2004

Reference Documents .....	1
Document Issue Record .....	1
1. Introduction.....	1
2. Spacecraft AIT Flow.....	2
2.1. Annotated EQM AIT flow .....	2
2.2. Annotated PFM AIT Flow .....	3
3. ESD Protected Instrument Configurations.....	5
4. Specification of safeing connectors .....	12
Appendix One – Location of Safeing Plugs in Config. 6 .....	17

## Reference Documents

RD-1 HP-2-ASED-PL-0021 Issue 2

RD-2 Astrium HP-2-ASED-PL-0031 Issue 1

## Document Issue Record

Issue Number	Date	Changes
0.1 Draft	Friday, 11 June 2004	Initial release for comment
	Tuesday, 15 June 2004	Added safeing plugs for the SMEC and BSM
0.2 Draft	Friday, 18 June 2004	Revise and update
1.0	Monday, 06 September 2004	Deleted section 5 regarding status lists of integration procedures

## 1. Introduction

This note outlines the precautions to be taken to protect the focal plane units of SPIRE from ESD damage during AIT when they are not connected to the DRCU. Particular attention is paid to the spacecraft EQM and PFM AIT phases.

Section 2 of this note outlines the AIT sequence of the Spacecraft for both the EQM and PFM AIT programmes. The AIT flow charts are taken from RD-1 and RD-2 and are included for information only. The flowcharts are annotated to indicate the particular configuration of ESD protection hardware required at different stages of the EQM and PFM programmes.

Section 3 specifies the configuration that the instrument will be in to keep the focal plane units from being damaged by ESD events. These instrument configurations have been annotated on the flow charts in section 2.

Section 4 specifies the main details of the hardware identified in section 3 .

As some new hardware has been specified in this document, various procedures will need to be revised and possibly updated to reflect this new information. Comments on the existing procedures are included in section **Error! Reference source not found.**

## 2. Spacecraft AIT Flow

### 2.1. Annotated EQM AIT flow

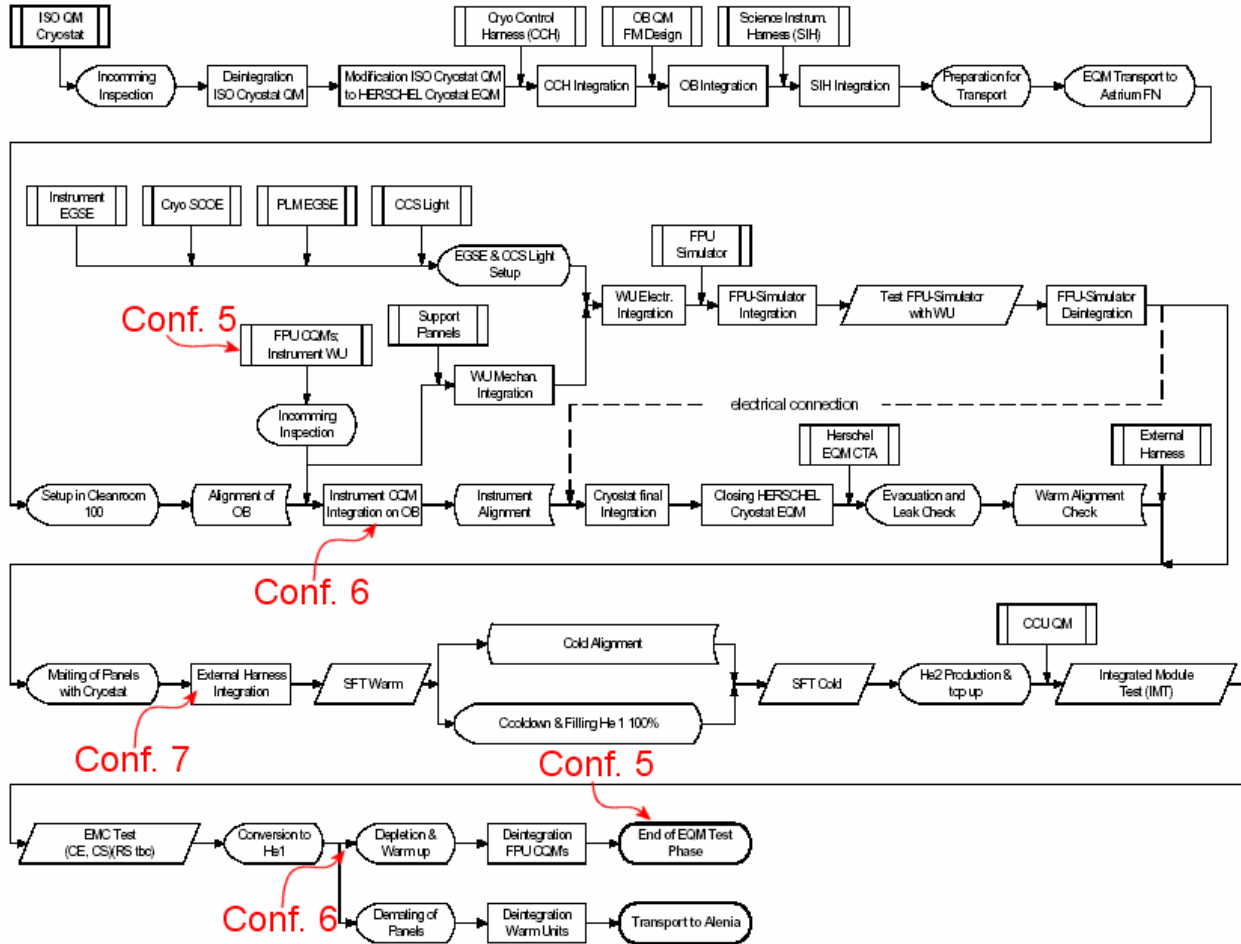

Figure 1 – Annotated EQM AIT Flow chart. Un-marked-up chart for reference only, from Astrium HP-2-ASED-PL-0021 Issue 2

## 2.2. Annotated PFM AIT Flow

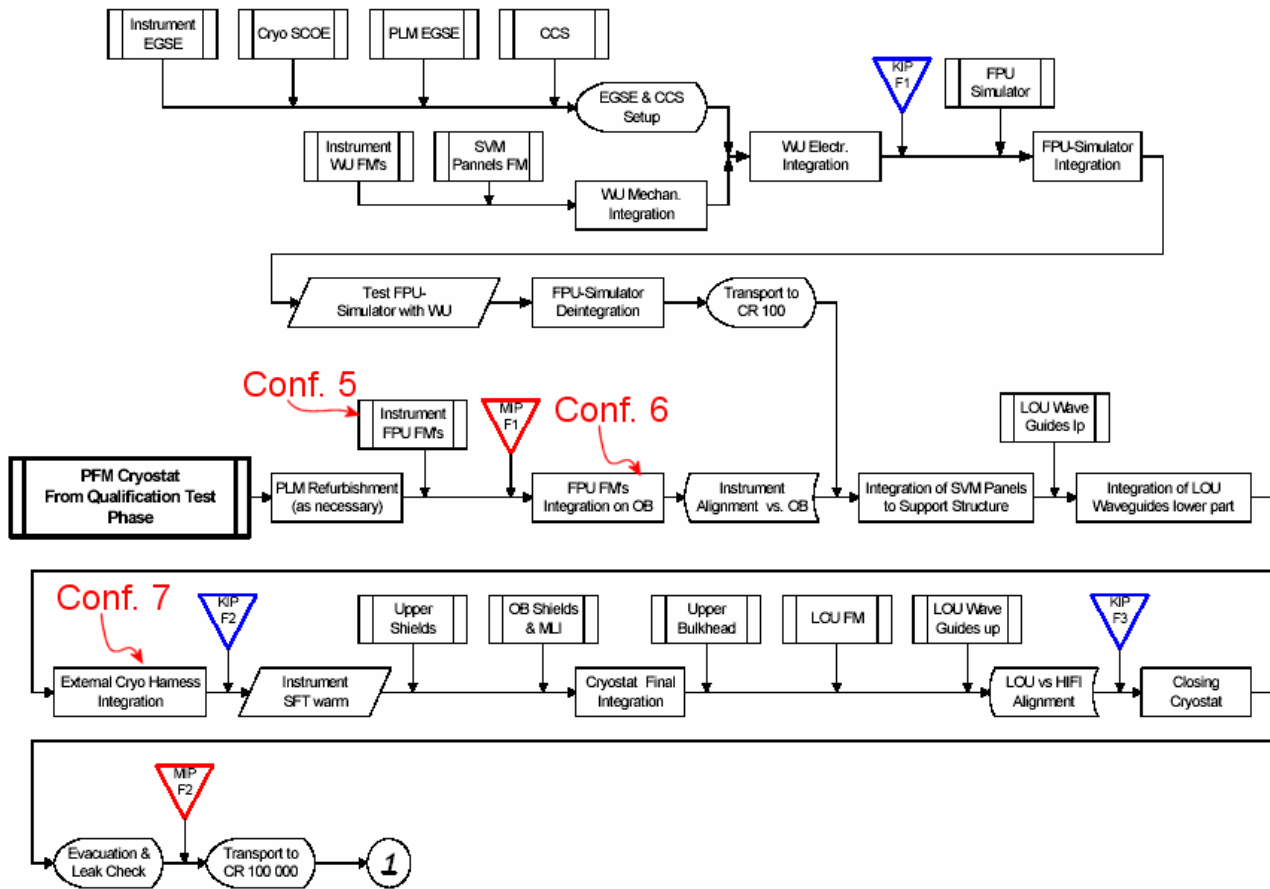

Figure 2 – Annotated PFM AIT Flow chart Un-marked-up chart for reference only, from Astrium HP-2-ASED-PL-0031 Issue 1

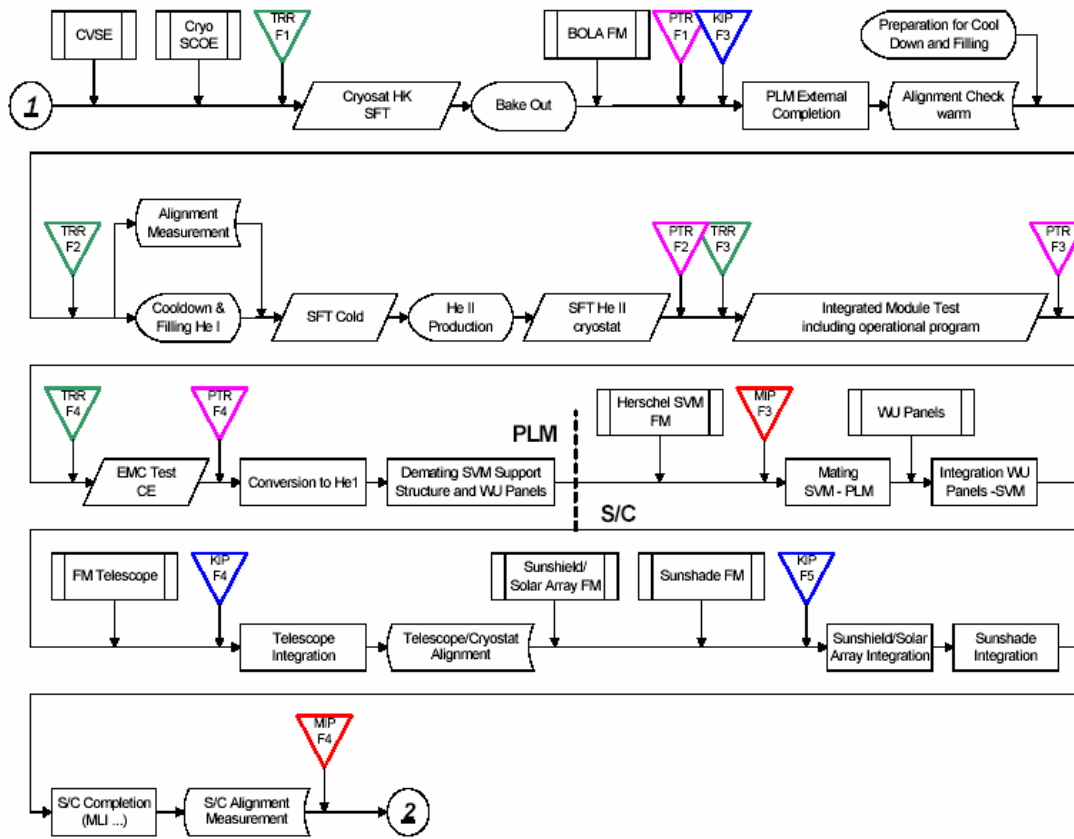
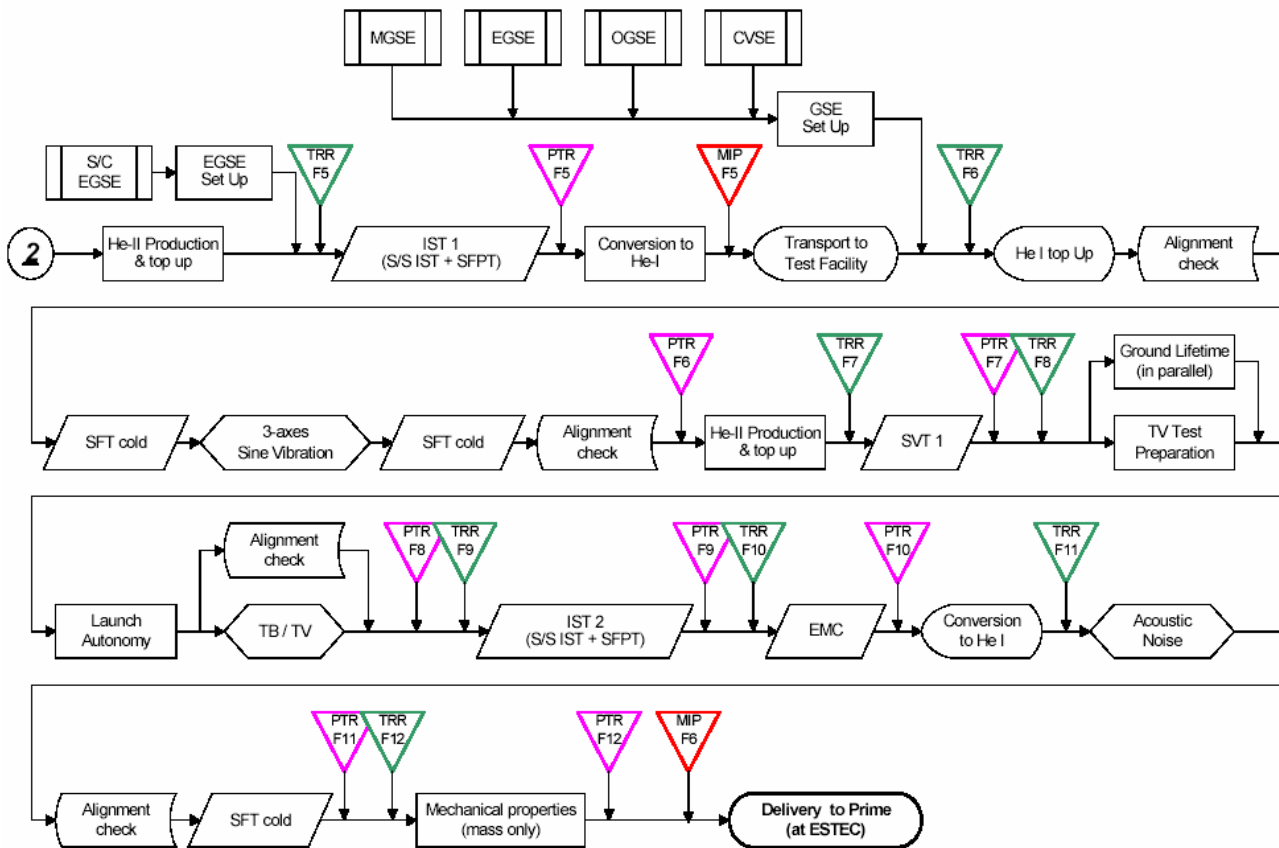
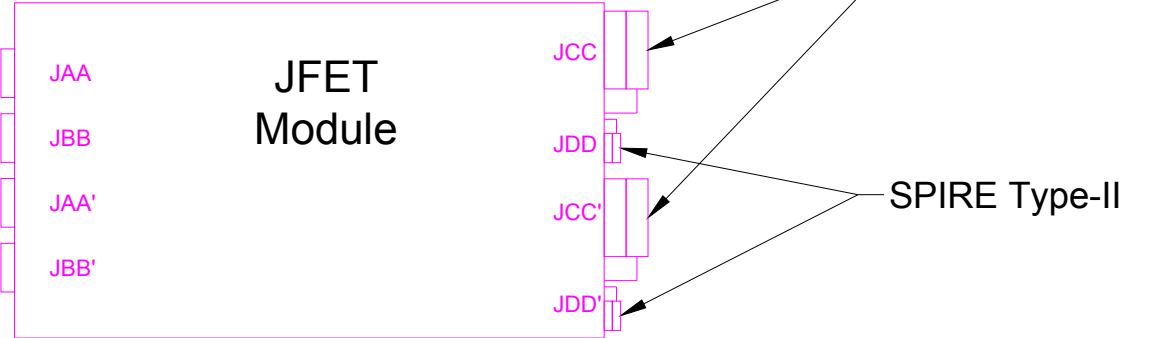
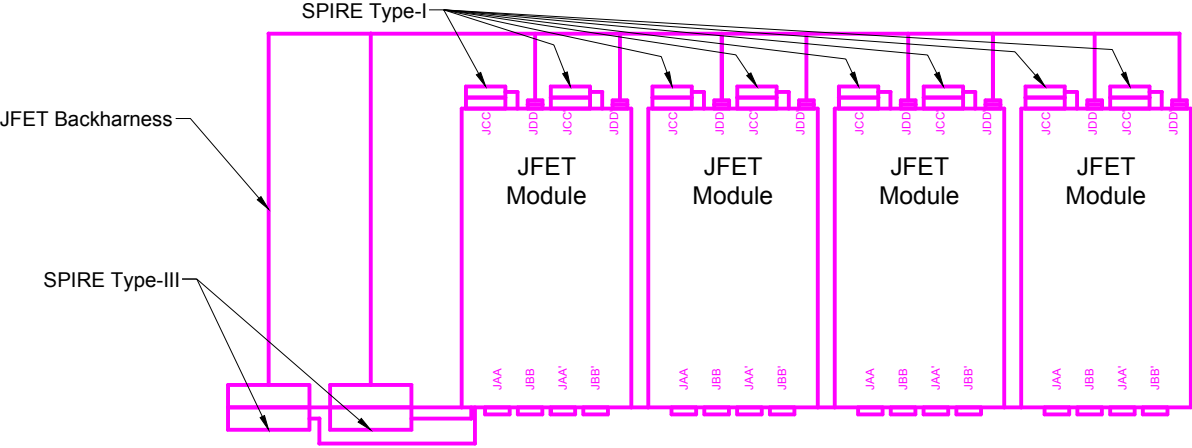

Figure 3 - PFM AIT Flow (for reference only, from Astrium HP-2-ASED-PL-0031 Issue 1)



### 3. ESD Protected Instrument Configurations

Instrument Configuration	Location/State of Instrument	ESD Protection Details
Config. 1	<ul style="list-style-type: none"> <li>JFET modules as delivered and not integrated into JFET racks</li> </ul>	 <ul style="list-style-type: none"> <li>SPIRE safeing plugs Type-I used to protect gates of JFETs</li> <li>SPIRE safeing plugs Type-II used to protect drain and sources of JFETs</li> </ul> <p><b>Comments</b></p> <ul style="list-style-type: none"> <li>The outputs of the JFETs are left open (JAA, JBB, JAA' and JBB'); a discharge to these could damage the devices</li> </ul>

Instrument Configuration	Location/State of Instrument	ESD Protection Details
Config. 2	<ul style="list-style-type: none"> <li>JFET Modules integrated into JFET racks</li> <li>JFET Backharnesses installed</li> <li>No external harness connected to JFETS</li> </ul>	 <p>The diagram shows four JFET Modules in a rack. Each module has four gates at the top, labeled JCC and JDE. SPIRE Type-I safeing plugs are connected to these gates. At the bottom of each module, there are four output pins labeled JAA, JBB, JAA', and JBB'. SPIRE Type-III safeing plugs are connected to these output pins. A JFET Backharness is shown on the left, and SPIRE Type-III safeing plugs are shown at the bottom left of the rack.</p> <ul style="list-style-type: none"> <li>SPIRE safeing plugs Type-I used to protect gates of JFETs</li> <li>SPIRE safeing plugs Type-III used to protect drain and sources of JFETs</li> </ul> <p><b>Comments</b></p> <ul style="list-style-type: none"> <li>The outputs of the JFETs are left open (JAA, JBB, JAA' and JBB'); a discharge to these could damage the devices</li> </ul>

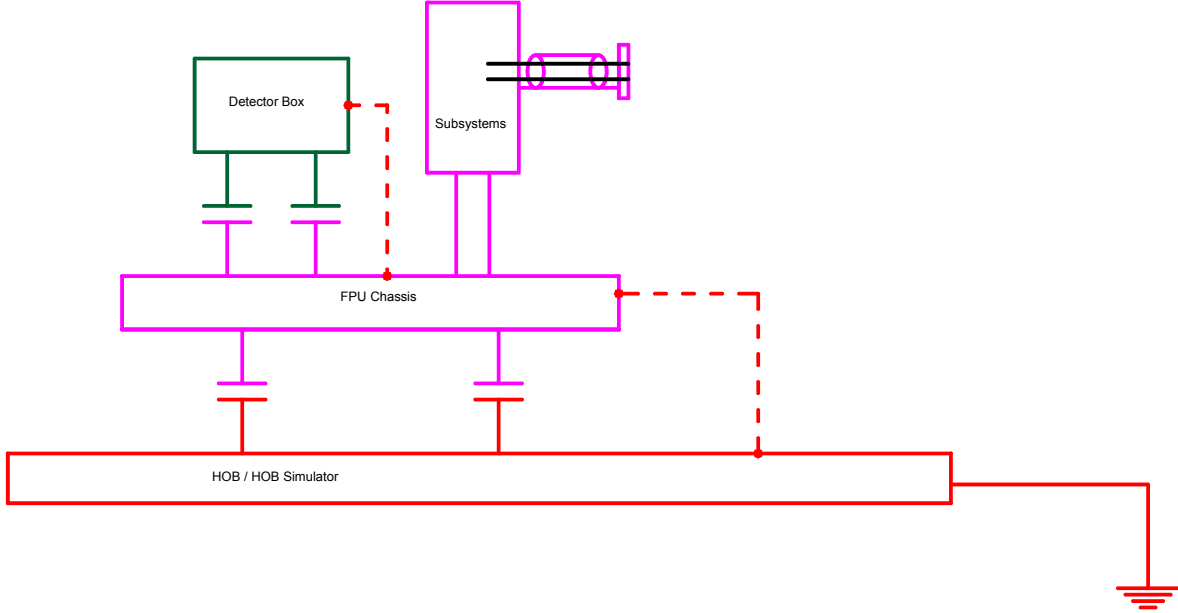
Instrument Configuration	Location/State of Instrument	ESD Protection Details
Config. 3	<ul style="list-style-type: none"> <li>• During integration</li> <li>• Covers off</li> <li>• JFETs not connected</li> <li>• BDA Harnesses not connected</li> </ul>	 <p>The diagram illustrates the ESD protection setup. It features four main components: a green 'Detector Box' at the top left, a purple 'Subsystems' box at the top right, a purple 'FPU Chassis' in the middle, and a red 'HOB / HOB Simulator' at the bottom. The Detector Box and Subsystems are connected to the FPU Chassis. The FPU Chassis is connected to the HOB / HOB Simulator. Red dashed lines indicate grounding straps: one connects the Detector Box to the FPU Chassis, another connects the Subsystems to the FPU Chassis, and a third connects the FPU Chassis to the HOB / HOB Simulator. The HOB / HOB Simulator is grounded to a common ground symbol on the right. Purple and red symbols represent capacitors or filters connected to the FPU Chassis.</p> <ul style="list-style-type: none"> <li>• Red Tag grounding strap connecting the Photometer Detector Box to FPU Chassis</li> <li>• Red Tag grounding strap connecting the Spectrometer Detector Box to FPU Chassis</li> <li>• Red Tag grounding strap connecting FPU Chassis to Optical Bench</li> <li>• Lumalloy film covering exposed BDA connectors.</li> <li>• No safeing plugs on the subsystem connectors</li> </ul> <p><b>Comments</b></p> <ul style="list-style-type: none"> <li>• A discharge to the BDA connector pins could damage the detectors and/or the bias resistors</li> <li>• The subsystem are left unprotected (except for the protection afforded by the Cristek filters)</li> </ul>

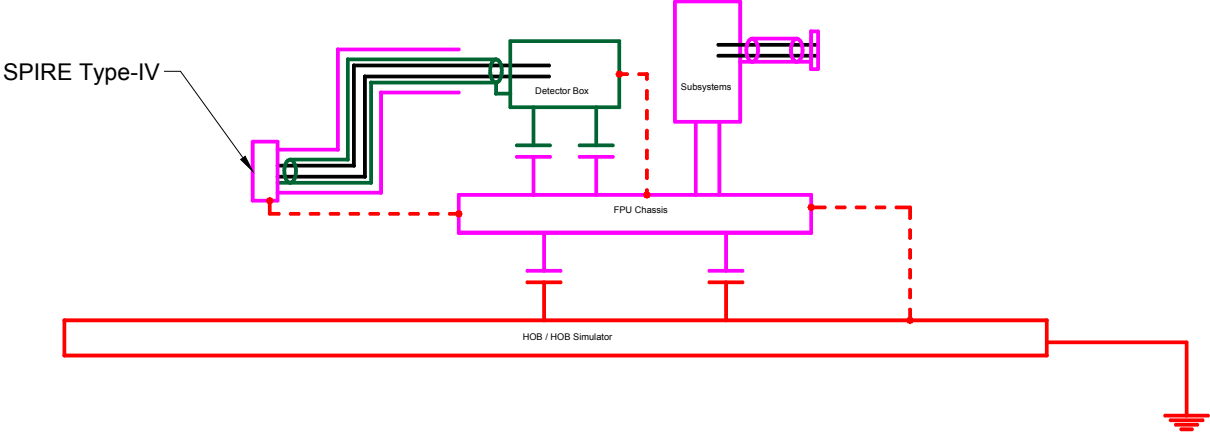
Instrument Configuration	Location/State of Instrument	ESD Protection Details
Config. 4	<ul style="list-style-type: none"> <li>• During integration</li> <li>• Covers off</li> <li>• JFETs not connected</li> <li>• BDA Harnesses connected</li> </ul>	 <ul style="list-style-type: none"> <li>• Red Tag grounding strap connecting the Photometer Detector Box to FPU Chassis</li> <li>• Red Tag grounding strap connecting the Spectrometer Detector Box to FPU Chassis</li> <li>• Red Tag grounding strap connecting FPU Chassis to Optical Bench</li> <li>• One MDM51P safeing plug SPIRE-Type IV protecting Photometer BDAs</li> <li>• One MDM51P safeing plug SPIRE-Type IV protecting Spectrometer BDAs</li> <li>• Exposed, un-terminated MDM51 connectors stowed inside Lumalloy bags</li> </ul>

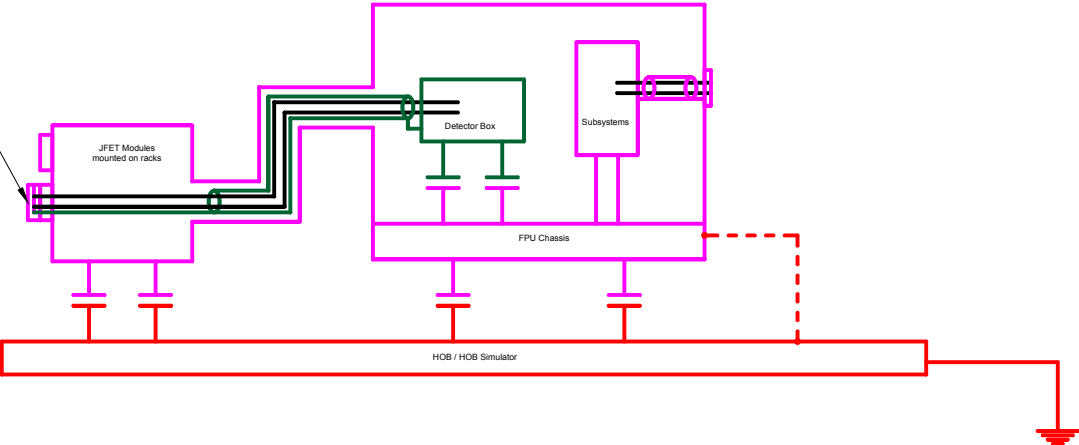

Instrument Configuration	Location/State of Instrument	ESD Protection Details
Config. 5	<ul style="list-style-type: none"> <li>Covers ON</li> <li>BDA - JFETs harnesses connected</li> <li>JFET backharnesses pre-installed on JFETs</li> </ul>	<div style="display: flex; align-items: flex-start;"> <div style="margin-right: 20px;"> <p>SPIRE Type-III</p>  </div> <div> <ul style="list-style-type: none"> <li>Red Tag grounding strap connecting FPU Chassis to Optical Bench</li> <li>Four MDM 37S safeing plugs (SPIRE Type-V) on Photometer Bias connectors (JFP J25, J26, J27 and J28)</li> <li>Two MDM 37S safeing plugs (SPIRE Type-V) on Spectrometer Bias connectors (JFS J09 and J10)</li> <li>Lumalloy bag covering exposed MDM25P connectors</li> </ul> <p><b>Comments</b></p> <ul style="list-style-type: none"> <li>This is the configuration used for transport of the cold plane units.</li> </ul> </div> </div>

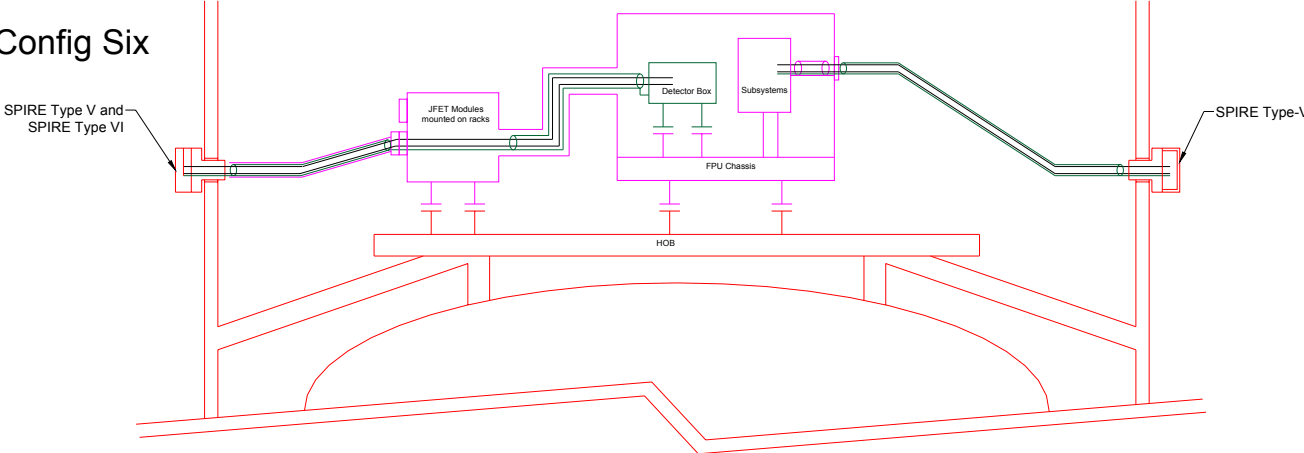
Instrument Configuration	Location/State of Instrument	ESD Protection Details
Config. 6	<ul style="list-style-type: none"> <li>• Covers ON</li> <li>• BDA - JFETs harnesses connected</li> <li>• JFET backharnesses pre-installed on JFETs</li> <li>• Internal SIH installed (i.e. Cryoharness)</li> <li>• Cryostat closed and therefore no further access to focal plane until possible!</li> <li>• SIH not connecting WE to cold plane units.</li> </ul>	<p><b>Config Six</b></p>  <p><b>Comments</b></p> <ul style="list-style-type: none"> <li>• Safeing plug (SPIRE Type-V) on Photometer bias</li> <li>• Safeing plug (SPIRE Type-VI) on Spectrometer bias</li> <li>• Safeing plug (SPIRE Type-VIII) on C11 and C13</li> <li>• EMC Backshell (SPIRE Type-VIII) on other active exposed harnesses</li> </ul> <p>See Appendix One for details of the applicability of safeing plugs in this configuration</p>

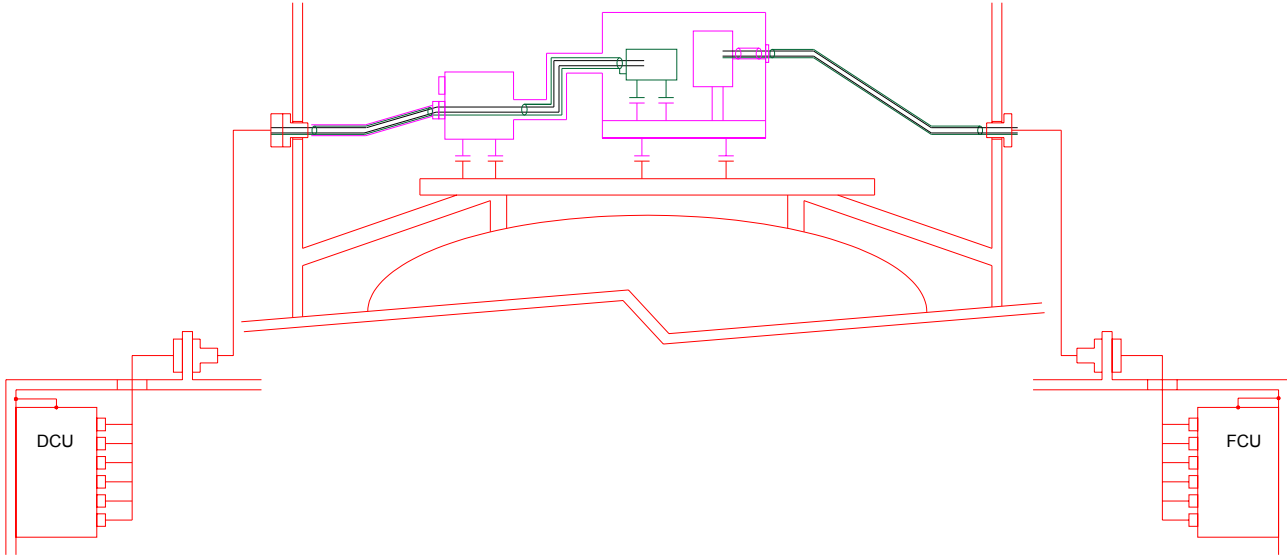
Instrument Configuration	Location/State of Instrument	ESD Protection Details
Config. 7	<ul style="list-style-type: none"><li>• FPU/JFETs integrated on optics bench</li><li>• Cryoharness fully integrated</li><li>• DRCU fully integrated</li></ul>	 <p><b>Comments</b></p> <p><b>A. For EQM:</b></p> <ul style="list-style-type: none"><li>• Only Phot Bias (C3), PLW Detector harness (C6) and prime S/S harnesses (C10/C11) connected.</li></ul> <p><b>B. For PFM:</b></p> <ul style="list-style-type: none"><li>• All detector and subsystem harnesses used</li></ul>

### 4. Specification of safeing connectors

Name	Details
SPIRE Types I and II	<p>The diagram illustrates the internal circuitry of a JFET Module. It features three main connectors: a 51-way connector on the left (SPIRE Type-I), a 15-way connector in the middle, and a 15-way connector on the right (SPIRE Type-II). The 51-way connector is labeled with pins 1 through 51. The 15-way connector in the middle is labeled with pins 1 through 15. The 15-way connector on the right is labeled with pins 1 through 15. The circuit includes two JFETs. The gates of the JFETs are connected to the 51-way connector. The drains of the JFETs are connected to the 15-way connector in the middle. A 25-way connector at the bottom provides signal inputs, labeled '- signal' and '+ signal'. Power and bias connections are labeled: V-, V+, Bias grd, Vdd 1, Vdd 2, Vss1, and Vss2. A 'Typical Circuit (30x)' is shown for the JFETs, and 'Gate jumper' labels indicate connection points.</p> <ul style="list-style-type: none"> <li>• Type-I used on JFET inputs JCC and JCC'</li> <li>• Type-II used on JFET bias input JDD and JDD'</li> <li>• SPIRE Provided</li> </ul>

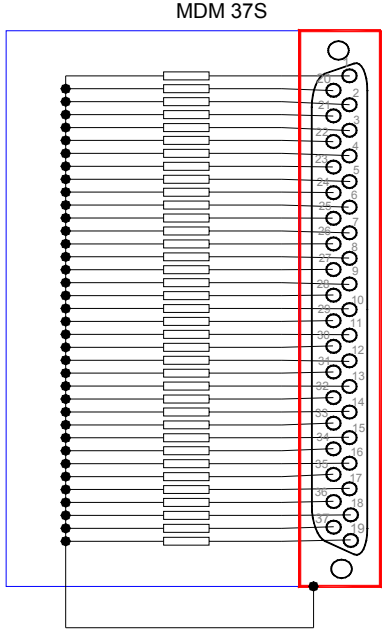
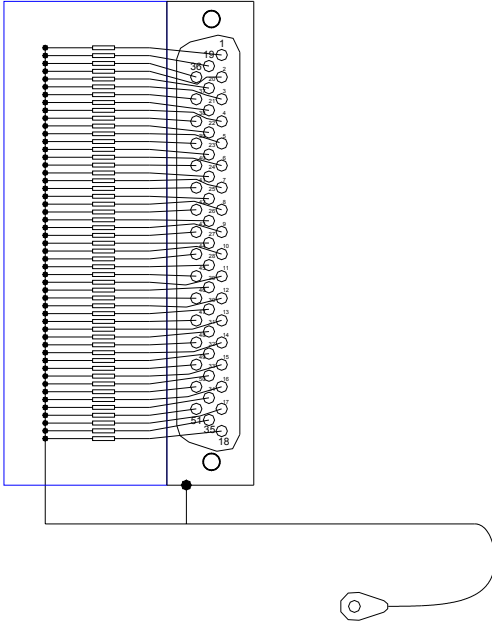
Name	Details
SPIRE Type-III	<div style="text-align: center;">  <p>MDM 37S</p> </div> <ul style="list-style-type: none"> <li>• 37 x 1Meg Ohm resistors to chassis of connector</li> <li>• Mates with Phot JFET Backharness JFP J25, J26, J27 and J28. Four required.</li> <li>• Mates with Spect. JFET Backharness JFS J09 and J10</li> <li>• SPIRE Provided</li> </ul>
SPIRE Type -IV	<div style="text-align: center;">  <p>MDM 51S</p> </div> <ul style="list-style-type: none"> <li>• 51 x 1Meg Ohm resistors to chassis of connector</li> <li>• Solder tab to connect backshell to chassis of FPU/Detector box approximately 400mm long</li> <li>• One required for photometer side of instrument.</li> <li>• One required for spectrometer side of instrument</li> <li>• SPIRE Provided</li> </ul>

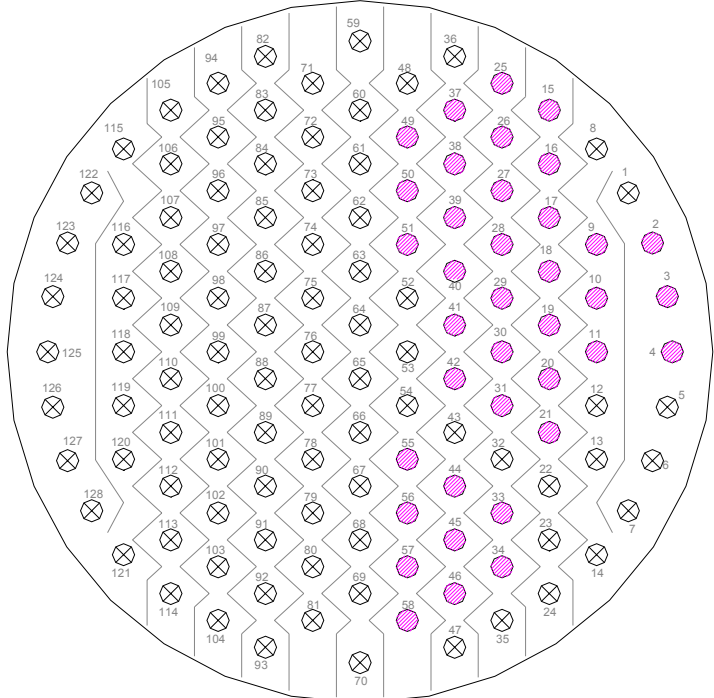

Name	Details
SPIRE Type-VI	
	<ul style="list-style-type: none"> <li>• 128-Way safting plug for Spectrometer JFETs and BDAs</li> <li>• 23 x 1Meg Ohm resistors to chassis of connector</li> <li>• ESA (Industry) provided</li> </ul>

Name	Details																																																																																																																																																																																																																																																																
SPIRE Type-VII	<ul style="list-style-type: none"> <li>• ESA (Industry) provided</li> <li>• EMC Backshell providing a 360° electrically conductive barrier over the exposed contacts</li> </ul>																																																																																																																																																																																																																																																																
SPIRE Type-VIII	<div style="display: flex; align-items: center;">  <div style="margin-left: 20px;"> <table border="0"> <tr><td>1</td><td>NC</td></tr> <tr><td>2</td><td>NC</td></tr> <tr><td>3</td><td>NC</td></tr> <tr><td>4</td><td>NC</td></tr> <tr><td>5</td><td>NC</td></tr> <tr><td>6</td><td>NC</td></tr> <tr><td>7</td><td>NC</td></tr> <tr><td>8</td><td>NC</td></tr> <tr><td>9</td><td>NC</td></tr> <tr><td>10</td><td>NC</td></tr> <tr><td>11</td><td>NC</td></tr> <tr><td>12</td><td>NC</td></tr> <tr><td>13</td><td>NC</td></tr> <tr><td>14</td><td>NC</td></tr> <tr><td>15</td><td>NC</td></tr> <tr><td>16</td><td>NC</td></tr> <tr><td>17</td><td>NC</td></tr> <tr><td>18</td><td>NC</td></tr> <tr><td>19</td><td>NC</td></tr> <tr><td>20</td><td>NC</td></tr> <tr><td>21</td><td>NC</td></tr> <tr><td>22</td><td>NC</td></tr> <tr><td>23</td><td>NC</td></tr> <tr><td>24</td><td>NC</td></tr> <tr><td>25</td><td>NC</td></tr> <tr><td>26</td><td>NC</td></tr> <tr><td>27</td><td>NC</td></tr> <tr><td>28</td><td>NC</td></tr> <tr><td>29</td><td>NC</td></tr> <tr><td>30</td><td>NC</td></tr> <tr><td>31</td><td>NC</td></tr> <tr><td>32</td><td>NC</td></tr> <tr><td>33</td><td>NC</td></tr> <tr><td>34</td><td>NC</td></tr> <tr><td>35</td><td>NC</td></tr> <tr><td>36</td><td>NC</td></tr> <tr><td>37</td><td>NC</td></tr> <tr><td>38</td><td>NC</td></tr> <tr><td>39</td><td>NC</td></tr> <tr><td>40</td><td>NC</td></tr> <tr><td>41</td><td>NC</td></tr> <tr><td>42</td><td>NC</td></tr> <tr><td>43</td><td>NC</td></tr> <tr><td>44</td><td>NC</td></tr> <tr><td>45</td><td>NC</td></tr> <tr><td>46</td><td>NC</td></tr> <tr><td>47</td><td>NC</td></tr> <tr><td>48</td><td>NC</td></tr> <tr><td>49</td><td>NC</td></tr> <tr><td>50</td><td>NC</td></tr> <tr><td>51</td><td>NC</td></tr> <tr><td>52</td><td>NC</td></tr> <tr><td>53</td><td>NC</td></tr> <tr><td>54</td><td>NC</td></tr> <tr><td>55</td><td>NC</td></tr> <tr><td>56</td><td>NC</td></tr> <tr><td>57</td><td>NC</td></tr> <tr><td>58</td><td>NC</td></tr> <tr><td>59</td><td>NC</td></tr> <tr><td>60</td><td>NC</td></tr> <tr><td>61</td><td>NC</td></tr> <tr><td>62</td><td>NC</td></tr> <tr><td>63</td><td>NC</td></tr> <tr><td>64</td><td>NC</td></tr> <tr><td>65</td><td>NC</td></tr> <tr><td>66</td><td>NC</td></tr> <tr><td>67</td><td>NC</td></tr> <tr><td>68</td><td>NC</td></tr> <tr><td>69</td><td>NC</td></tr> <tr><td>70</td><td>NC</td></tr> <tr><td>71</td><td>NC</td></tr> <tr><td>72</td><td>NC</td></tr> <tr><td>73</td><td>NC</td></tr> <tr><td>74</td><td>NC</td></tr> <tr><td>75</td><td>NC</td></tr> <tr><td>76</td><td>NC</td></tr> <tr><td>77</td><td>NC</td></tr> <tr><td>78</td><td>NC</td></tr> <tr><td>79</td><td>NC</td></tr> <tr><td>80</td><td>NC</td></tr> <tr><td>81</td><td>NC</td></tr> <tr><td>82</td><td>NC</td></tr> <tr><td>83</td><td>NC</td></tr> <tr><td>84</td><td>NC</td></tr> <tr><td>85</td><td>NC</td></tr> <tr><td>86</td><td>NC</td></tr> <tr><td>87</td><td>NC</td></tr> <tr><td>88</td><td>NC</td></tr> <tr><td>89</td><td>NC</td></tr> <tr><td>90</td><td>NC</td></tr> <tr><td>91</td><td>NC</td></tr> <tr><td>92</td><td>NC</td></tr> <tr><td>93</td><td>NC</td></tr> <tr><td>94</td><td>NC</td></tr> <tr><td>95</td><td>NC</td></tr> <tr><td>96</td><td>NC</td></tr> <tr><td>97</td><td>NC</td></tr> <tr><td>98</td><td>NC</td></tr> <tr><td>99</td><td>NC</td></tr> <tr><td>100</td><td>NC</td></tr> <tr><td>101</td><td>NC</td></tr> <tr><td>102</td><td>NC</td></tr> <tr><td>103</td><td>NC</td></tr> <tr><td>104</td><td>NC</td></tr> <tr><td>105</td><td>NC</td></tr> <tr><td>106</td><td>NC</td></tr> <tr><td>107</td><td>NC</td></tr> <tr><td>108</td><td>NC</td></tr> <tr><td>109</td><td>NC</td></tr> <tr><td>110</td><td>NC</td></tr> <tr><td>111</td><td>NC</td></tr> <tr><td>112</td><td>NC</td></tr> <tr><td>113</td><td>NC</td></tr> <tr><td>114</td><td>NC</td></tr> <tr><td>115</td><td>NC</td></tr> <tr><td>116</td><td>NC</td></tr> <tr><td>117</td><td>NC</td></tr> <tr><td>118</td><td>NC</td></tr> <tr><td>119</td><td>NC</td></tr> <tr><td>120</td><td>NC</td></tr> <tr><td>121</td><td>NC</td></tr> <tr><td>122</td><td>NC</td></tr> <tr><td>123</td><td>NC</td></tr> <tr><td>124</td><td>NC</td></tr> <tr><td>125</td><td>NC</td></tr> <tr><td>126</td><td>NC</td></tr> <tr><td>127</td><td>NC</td></tr> <tr><td>128</td><td>NC</td></tr> </table> </div> </div> <div style="margin-top: 20px;"> <ul style="list-style-type: none"> <li>• 128-Way safeing plug for SMEC and BSM cryogenic electronics</li> <li>• 38 x 1Meg Ohm resistors to chassis of connector</li> <li>• ESA (Industry) provided</li> </ul> </div>	1	NC	2	NC	3	NC	4	NC	5	NC	6	NC	7	NC	8	NC	9	NC	10	NC	11	NC	12	NC	13	NC	14	NC	15	NC	16	NC	17	NC	18	NC	19	NC	20	NC	21	NC	22	NC	23	NC	24	NC	25	NC	26	NC	27	NC	28	NC	29	NC	30	NC	31	NC	32	NC	33	NC	34	NC	35	NC	36	NC	37	NC	38	NC	39	NC	40	NC	41	NC	42	NC	43	NC	44	NC	45	NC	46	NC	47	NC	48	NC	49	NC	50	NC	51	NC	52	NC	53	NC	54	NC	55	NC	56	NC	57	NC	58	NC	59	NC	60	NC	61	NC	62	NC	63	NC	64	NC	65	NC	66	NC	67	NC	68	NC	69	NC	70	NC	71	NC	72	NC	73	NC	74	NC	75	NC	76	NC	77	NC	78	NC	79	NC	80	NC	81	NC	82	NC	83	NC	84	NC	85	NC	86	NC	87	NC	88	NC	89	NC	90	NC	91	NC	92	NC	93	NC	94	NC	95	NC	96	NC	97	NC	98	NC	99	NC	100	NC	101	NC	102	NC	103	NC	104	NC	105	NC	106	NC	107	NC	108	NC	109	NC	110	NC	111	NC	112	NC	113	NC	114	NC	115	NC	116	NC	117	NC	118	NC	119	NC	120	NC	121	NC	122	NC	123	NC	124	NC	125	NC	126	NC	127	NC	128	NC
1	NC																																																																																																																																																																																																																																																																
2	NC																																																																																																																																																																																																																																																																
3	NC																																																																																																																																																																																																																																																																
4	NC																																																																																																																																																																																																																																																																
5	NC																																																																																																																																																																																																																																																																
6	NC																																																																																																																																																																																																																																																																
7	NC																																																																																																																																																																																																																																																																
8	NC																																																																																																																																																																																																																																																																
9	NC																																																																																																																																																																																																																																																																
10	NC																																																																																																																																																																																																																																																																
11	NC																																																																																																																																																																																																																																																																
12	NC																																																																																																																																																																																																																																																																
13	NC																																																																																																																																																																																																																																																																
14	NC																																																																																																																																																																																																																																																																
15	NC																																																																																																																																																																																																																																																																
16	NC																																																																																																																																																																																																																																																																
17	NC																																																																																																																																																																																																																																																																
18	NC																																																																																																																																																																																																																																																																
19	NC																																																																																																																																																																																																																																																																
20	NC																																																																																																																																																																																																																																																																
21	NC																																																																																																																																																																																																																																																																
22	NC																																																																																																																																																																																																																																																																
23	NC																																																																																																																																																																																																																																																																
24	NC																																																																																																																																																																																																																																																																
25	NC																																																																																																																																																																																																																																																																
26	NC																																																																																																																																																																																																																																																																
27	NC																																																																																																																																																																																																																																																																
28	NC																																																																																																																																																																																																																																																																
29	NC																																																																																																																																																																																																																																																																
30	NC																																																																																																																																																																																																																																																																
31	NC																																																																																																																																																																																																																																																																
32	NC																																																																																																																																																																																																																																																																
33	NC																																																																																																																																																																																																																																																																
34	NC																																																																																																																																																																																																																																																																
35	NC																																																																																																																																																																																																																																																																
36	NC																																																																																																																																																																																																																																																																
37	NC																																																																																																																																																																																																																																																																
38	NC																																																																																																																																																																																																																																																																
39	NC																																																																																																																																																																																																																																																																
40	NC																																																																																																																																																																																																																																																																
41	NC																																																																																																																																																																																																																																																																
42	NC																																																																																																																																																																																																																																																																
43	NC																																																																																																																																																																																																																																																																
44	NC																																																																																																																																																																																																																																																																
45	NC																																																																																																																																																																																																																																																																
46	NC																																																																																																																																																																																																																																																																
47	NC																																																																																																																																																																																																																																																																
48	NC																																																																																																																																																																																																																																																																
49	NC																																																																																																																																																																																																																																																																
50	NC																																																																																																																																																																																																																																																																
51	NC																																																																																																																																																																																																																																																																
52	NC																																																																																																																																																																																																																																																																
53	NC																																																																																																																																																																																																																																																																
54	NC																																																																																																																																																																																																																																																																
55	NC																																																																																																																																																																																																																																																																
56	NC																																																																																																																																																																																																																																																																
57	NC																																																																																																																																																																																																																																																																
58	NC																																																																																																																																																																																																																																																																
59	NC																																																																																																																																																																																																																																																																
60	NC																																																																																																																																																																																																																																																																
61	NC																																																																																																																																																																																																																																																																
62	NC																																																																																																																																																																																																																																																																
63	NC																																																																																																																																																																																																																																																																
64	NC																																																																																																																																																																																																																																																																
65	NC																																																																																																																																																																																																																																																																
66	NC																																																																																																																																																																																																																																																																
67	NC																																																																																																																																																																																																																																																																
68	NC																																																																																																																																																																																																																																																																
69	NC																																																																																																																																																																																																																																																																
70	NC																																																																																																																																																																																																																																																																
71	NC																																																																																																																																																																																																																																																																
72	NC																																																																																																																																																																																																																																																																
73	NC																																																																																																																																																																																																																																																																
74	NC																																																																																																																																																																																																																																																																
75	NC																																																																																																																																																																																																																																																																
76	NC																																																																																																																																																																																																																																																																
77	NC																																																																																																																																																																																																																																																																
78	NC																																																																																																																																																																																																																																																																
79	NC																																																																																																																																																																																																																																																																
80	NC																																																																																																																																																																																																																																																																
81	NC																																																																																																																																																																																																																																																																
82	NC																																																																																																																																																																																																																																																																
83	NC																																																																																																																																																																																																																																																																
84	NC																																																																																																																																																																																																																																																																
85	NC																																																																																																																																																																																																																																																																
86	NC																																																																																																																																																																																																																																																																
87	NC																																																																																																																																																																																																																																																																
88	NC																																																																																																																																																																																																																																																																
89	NC																																																																																																																																																																																																																																																																
90	NC																																																																																																																																																																																																																																																																
91	NC																																																																																																																																																																																																																																																																
92	NC																																																																																																																																																																																																																																																																
93	NC																																																																																																																																																																																																																																																																
94	NC																																																																																																																																																																																																																																																																
95	NC																																																																																																																																																																																																																																																																
96	NC																																																																																																																																																																																																																																																																
97	NC																																																																																																																																																																																																																																																																
98	NC																																																																																																																																																																																																																																																																
99	NC																																																																																																																																																																																																																																																																
100	NC																																																																																																																																																																																																																																																																
101	NC																																																																																																																																																																																																																																																																
102	NC																																																																																																																																																																																																																																																																
103	NC																																																																																																																																																																																																																																																																
104	NC																																																																																																																																																																																																																																																																
105	NC																																																																																																																																																																																																																																																																
106	NC																																																																																																																																																																																																																																																																
107	NC																																																																																																																																																																																																																																																																
108	NC																																																																																																																																																																																																																																																																
109	NC																																																																																																																																																																																																																																																																
110	NC																																																																																																																																																																																																																																																																
111	NC																																																																																																																																																																																																																																																																
112	NC																																																																																																																																																																																																																																																																
113	NC																																																																																																																																																																																																																																																																
114	NC																																																																																																																																																																																																																																																																
115	NC																																																																																																																																																																																																																																																																
116	NC																																																																																																																																																																																																																																																																
117	NC																																																																																																																																																																																																																																																																
118	NC																																																																																																																																																																																																																																																																
119	NC																																																																																																																																																																																																																																																																
120	NC																																																																																																																																																																																																																																																																
121	NC																																																																																																																																																																																																																																																																
122	NC																																																																																																																																																																																																																																																																
123	NC																																																																																																																																																																																																																																																																
124	NC																																																																																																																																																																																																																																																																
125	NC																																																																																																																																																																																																																																																																
126	NC																																																																																																																																																																																																																																																																
127	NC																																																																																																																																																																																																																																																																
128	NC																																																																																																																																																																																																																																																																



## Appendix One – Location of Safeing Plugs in Config. 6

Instrument/Spacecraft Model	CVV-C/B to SVM-C/B SIH	SPIRE S/S	S/C Connector	SPIRE Safeing Plug
EQM	not present	Phot. Bias	CVV-CB P26	Type-V
		Spect. Bias	CVV-CB P32	Type-VI
		Active Detector Signals	CVV-CB P24	Type-VII
		Remaining Connectors	CVV-CB P31 CVV-CB P22 CVV-CB P23 CVV-CB P25 CVV-CB P27 CVV-CB P28 CVV-CB P34 CVV-CB P30 CVV-CB P33 CVV-CB P29	Nil
	present	Phot. Bias	SVM I/F-CB 312100 P04	Type-V
		Spect. Bias	SVM I/F-CB 312200 P06	Type-VI
		Detector Signals	SVM I/F-CB 312200 P03	Type-VII
		Remaining Connectors	SVM I/F-CB 312200 P05 SVM I/F-CB 312100 P03 SVM I/F-CB 312100 P02 SVM I/F-CB 312200 P04 SVM I/F-CB 312200 P01 SVM I/F-CB 312200 P02 SVM I/F-CB 312300 P06 SVM I/F-CB 312300 P05 SVM I/F-CB 312300 P03	Nil
		Phot. Bias	CVV-CB P26	Type-V
		Spect. Bias	CVV-CB P32	Type-VI
PFM	not present	Detector Signals	CVV-CB P31 CVV-CB P22 CVV-CB P23 CVV-CB P24 CVV-CB P25 CVV-CB P27 CVV-CB P28	Type-VII
		BSM / SMEC	CVV-CB P30 CVV-CB P29	Type-VIII
		Remaining Connectors	CVV-CB P34 CVV-CB P33	Type-VII
		Phot. Bias	SVM I/F-CB 312100 P04	Type-V
		Spect. Bias	SVM I/F-CB 312200 P06	Type-VI
		Detector Signals	SVM I/F-CB 312200 P05 SVM I/F-CB 312100 P03 SVM I/F-CB 312100 P02 SVM I/F-CB 312200 P03 SVM I/F-CB 312200 P04 SVM I/F-CB 312200 P01 SVM I/F-CB 312200 P02	Type-VII
	present	BSM / SMEC	SVM I/F-CB 312300 P04 SVM I/F-CB 312300 P03	Type-VIII
		Remaining Connectors	SVM I/F-CB 312300 P06 SVM I/F-CB 312300 P05	Type-VII