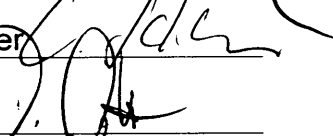
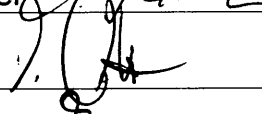
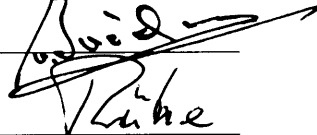
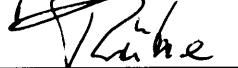

Title: Instrument Testing on PLM EQM Level

CI-No:

Prepared by:	S. Idler 	Date:	27.06.03
Checked by:	C. Schlosser 		27.06.03
Product Assurance:	R. Stritter 		27.06.03
Configuration Control:	A. v. Ivády 		27.06.03.
Project Management:	W. Rühle 		1.7.03

Distribution: See Distribution List (last page)

Copying of this document, and giving it to others and the use or communication of the contents thereof, are forbidden without express authority. Offenders are liable to the payment of damages. All rights are reserved in the event of the grant of a patent or the registration of a utility model or design.

Issue	Date	Sheet	Description of Change	Release
Draft	30.04.02	all	Draft for review and comments	
Issue 1	22.05.02	all	Initial issue	
Issue 2	06.06.03	all	Complete revision of issue 1, reflecting the development of the programme and taking into account related comments from the instrument contractors.	

List of Content

1	Scope	7
2	Documents	8
2.1	Applicable Documents	8
2.2	Reference Documents	8
3	Objective of EPLM EQM AIT Programme	9
3.1	EPLM EQM AIT Programme General Objectives	9
3.2	Instrument Specific Test Definitions and Objectives	9
4	EPLM EQM AIT Flow	11
4.1	Activities Overview	11
4.2	Instrument Specific Test Activities	12
4.2.1	Incoming Inspection	12
4.2.2	Instrument EGSE Validation	13
4.2.3	Electrical Integration Test	13
4.2.4	Alignment Check	14
4.2.5	Short Functional Test (SFT)	15
4.2.6	Specific Performance Test (SPT)	15
4.2.7	Integrated Module Test (IMT)	16
4.2.8	EMC Test	18
5	Instrument Configurations	22
5.1	Instrument Hardware Configuration	22
5.1.1	HIFI EQM Configuration	22
5.1.2	PACS EQM Configuration	23
5.1.3	SPIRE EQM Configuration	24
5.2	Instrument GSE Configuration	27
5.2.1	Instrument EGSE Configuration	27
5.2.2	Instrument MGSE Configuration	27
5.3	Instrument Documentation	28
5.3.1	EIDP	28
5.3.2	Test Sequences	28
6	Test Set-up	29

6.1	Principle EPLM Test Set-up	29
6.2	Test Facility	30
7	Instrument Specific Test Conditions and Constraints	32
7.1	Instrument Test Durations	32
7.2	FPU/LOU Operational Constraints	34
7.3	Spacecraft Orientation	35
7.4	Sensor Background	35
7.5	Thermal Environment	35
7.6	Cleanliness	36
7.7	Purging	36
7.8	ESD Procedures	36
7.9	Microvibration	36
7.10	Integration	37
8	Instrument Test Activity Descriptions	39
8.1	Incoming Inspection	40
8.1.1	HIFI Incoming Inspection	40
8.1.2	PACS Incoming Inspection	41
8.1.3	SPIRE Incoming Inspection	42
8.2	Instrument EGSE Validation	43
8.2.1	HIFI EGSE Check Out	43
8.2.2	PACS EGSE Check Out	44
8.2.3	SPIRE EGSE Check Out	45
8.3	Electrical Integration Test	46
8.3.1	HIFI Electrical Interface Test	46
8.3.2	PACS Electrical Interface Test	47
8.3.3	SPIRE Electrical Interface Test	48
8.4	Alignment Check	49
8.4.1	HIFI Alignment Test	49
8.5	Short Functional Test Warm	50
8.5.1	HIFI Short Functional Test Warm	50
8.5.2	PACS Short Functional Test Warm	51
8.5.3	SPIRE Short Functional Test Warm	52
8.6	Short Functional Test Cold He 1	53
8.6.1	HIFI Short Functional Test Cold He 1	53
8.6.2	PACS Short Functional Test Cold He 1	54

8.6.3	SPIRE Short Functional Test Cold He 1	55
8.7	Short Functional Test Cold He2	56
8.7.1	HIFI Short Functional Test Cold He2	56
8.7.2	PACS Short Functional Test Cold He2	57
8.7.3	SPIRE Short Functional Test Cold He2	58
8.8	Special Performance Tests	59
8.8.1	HIFI IF Properties	59
8.8.2	HIFI Radiometry	60
8.8.3	HIFI Reduced Standing Wave Test	61
8.8.4	PACS Full Functional Test	62
8.8.5	PACS Short Performance Test	63
8.8.6	PACS Astronomical Observation Template (AOT) Tests	64
8.8.7	PACS PACS/SPIRE Parallel Mode	65
8.8.8	SPIRE Cooler Recycle	66
8.8.9	SPIRE Photometer Chop Mode	67
8.8.10	SPIRE Ambient Background Verification	68
8.8.11	SPIRE Spectrometer Mode	69
8.8.12	SPIRE PACS/SPIRE Parallel Mode	70
8.9	Integrated Module Tests	71
8.9.1	HIFI Integrated Module Test	71
8.9.2	PACS Integrated Module Test	72
8.9.3	SPIRE Integrated Module Test	73
8.10	EMC Tests	74
8.10.1	HIFI EMC Test	74
8.10.2	PACS EMC Test	75
8.10.3	SPIRE EMC Test	76

List of Figures

Figure 4-1: EQM AIT Flow	11
Figure 4-2: IMT Activity Flow (proposal TBC by HIFI/PACS/SPIRE).....	17
Figure 4-3: EMC Test Activities Flow	19
Figure 6-1: Principle Test Set-up for EQM Tests.....	29
Figure 6-2: Data Exchange during EPLM EQM Test.....	30
Figure 6-3: Layout of Test Facility	31

List of Tables

Table 3-1: Instrument related Tests on EPLM EQM Level	10
Table 5-1: HIFI EQM Hardware Built Standards	23
Table 5-2: PACS EQM Hardware Built Standards	24
Table 5-3: SPIRE EQM Hardware Built Standards	26
Table 5-4: Instrument EGSE Items	27
Table 7-1: HIFI Test Duration	32
Table 7-2: PACS Test Duration	33
Table 7-3: SPIRE Test Duration	33
Table 7-4: Interface Temperatures provided by the EQM Cryostat (all values TBC).....	36

1 Scope

This plan defines the instrument tests to be performed on EPLM level during the Herschel EQM programme. This includes the instrument incoming inspections after delivery to ASED, the activities and interface tests planned for the instrument integration on the EPLM EQM and the instrument related tests to be performed during the various EPLM EQM test phases. All these activities and tests are described per instrument and per test activity in specific form sheets.

In addition, the document gives an overview on the EPLM EQM test programme, addresses the delivery and test configuration of the instruments and specifies any constraints to be respected for the instrument ground operations.

The main objective of this document is to allow an early, quick and co-ordinated EPLM EQM AIT relevant information exchange as regards the instrument related aspects. Therefore this document shall be used as reference document for the iteration cycles with the parties involved in the instrument related part of the EPLM EQM AIT programme. Furthermore this document serves as reference document for the higher level EPLM EQM AIT Plan (RD 1), in providing more details and more actual information with respect to instrument related subjects.

The document is based on the Instrument Interface Documents (AD 1, AD 2, AD 3 and AD 4) and the EPLM AIV and Satellite AIT Requirements Specification (AD 5) and takes into account the current status of the EPLM EQM AIT planning and the information provided by the instrument contractors. In case of changes of the planning this document will be updated accordingly ('living document').

It is intended to extend the scope of this document to serve as specification for the instrument related EPLM EQM test procedures

2 Documents

2.1 Applicable Documents

AD 1	SCI-PT-IIDA-04624	Herschel/Planck Instrument Interface Document, Part A	Issue 2/0, 31.07.2001
AD 2	SCI-PT-IIDB/SPIRE-02124	Herschel/Planck Instrument Interface Document, Part B, Instrument "SPIRE"	Issue 2/0, 31.07.2001
AD 3	SCI-PT-IIDB/HIFI-02125	Herschel/Planck Instrument Interface Document, Part B, Instrument "HIFI"	Issue 2/1, 03.01.2002
AD 4	SCI-PT-IIDB/PACS-02126	Herschel/Planck Instrument Interface Document, Part B, Instrument "PACS"	Issue 2/0, 31.07.2001
AD 5	HP-1-ASPI-SP-0008	Herschel EPLM AIV and Herschel Satellite AIT Requirements Specification	Issue 2, 23.07.2001
AD 6	HP-2-ASED-PL-0007	Herschel PA Plan	Issue 1, Rev. 3
AD 7	HP-2-ASED-PL-0023	Herschel Contamination Control Plan	Issue 1
AD 8	HP-1-ASPI-LI-0077	List of Acronyms	

2.2 Reference Documents

RD 1	HP-2-ASED-PL-0022	Herschel EPLM EQM AIT Plan	Issue 1, 12.03.2002
RD 2	HP-2-ASED-TN-0076	Optical Configuration and Straylight during Ground Testing	Issue 1
RD 3	H-P-1-ASPI-IS-0121	EGSE Interface Requirements Specification	Issue 3.1, 08.11.2002
RD 4	HP-2-ASED-TN-0041	HERSCHEL EQM Thermal Model and Analysis	Issue 2
RD 5	HP-2-ASED-TN-0002	Herschel Alignment Concept	Issue 2, 14.06.2002

3 Objective of EPLM EQM AIT Programme

3.1 EPLM EQM AIT Programme General Objectives

The main objective of the EQM test program on EPLM EQM level is to verify the mechanical, electrical, electromagnetic and thermal compatibility of the instruments with the EPLM in flight representative cryogenic conditions.

Another important objective is to validate the instrument integration, alignment and test procedures and the EPLM test set-up as far as possible and to gain experience in operating the EPLM and GSE for the PFM programme.

The EQM AIT programme uses the ISO QM cryostat which has especially been modified in some areas to represent as much as possible the Herschel cryostat.

There will be no satellite level EQM programme.

3.2 Instrument Specific Test Definitions and Objectives

The following table gives an overview of the instrument tests to be carried out on EPLM EQM level with their instrument related objectives.

Test	Test Objectives	Conditions	Remarks
Instrument Incoming Inspection	Visual inspection of the instrument for damage. Check of completeness of hardware items and documentation.	Ambient	
Instrument EGSE Validation	Check of Instrument EGSE function (self-test). Check of Instrument EGSE interfaces to CCS.	Ambient	Prior to start EPLM level instrument test programme.
Instrument Electrical Integration Check	Check of grounding, shielding and, if required, input/output circuits function and characteristics.	Ambient	Prior to connection of instrument to spacecraft. Prior to connection of FPU to warm units via the cryoharness.
Instrument Alignment Check	Check of instrument alignment and validation of alignment procedure (as far as possible).	All	In warm and cold conditions.

Test	Test Objectives	Conditions	Remarks
Instrument Short Functional Test (SFT)	Instrument switch on and functional verification of instrument interfaces. Evaluation should preferably be based on housekeeping data. Three different types of instrument SFT's: warm, cold He1 and cold He2.	SFT warm: Ambient SFT cold He1: Tank temperature 4.2 K SFT cold He2: Tank temperature 1.7 K	SFT warm: Before cool down of the cryostat. SFT cold He1: After cool down (He1). SFT cold He2: After He2 production..
Instrument Specific Performance Test (SPT)	Verification of dedicated aspects of the performance of the integrated instrument. Tests may require a specific spacecraft configuration.	Tank temperature: 1.7 K	Scheduling depending on test set-up requirements.
Integrated Module Test (IMT)	Verification of the functional performance of the integrated instrument in all possible modes. Check of the instrument performance as far as possible with EPLM configuration.	Tank temperature: 1.7 K	
EMC Test	Check of functional performance of the integrated instrument under electromagnetic worst case conditions (conducted and radiated susceptibility) and measurement of instrument electromagnetic emissions (conducted and radiated emission).	Tank temperature: 1.7 K	Instruments to be in the most sensitive mode(s) for susceptibility tests and most noisiest mode(s) for emission tests.

Table 3-1: Instrument related Tests on EPLM EQM Level

4 EPLM EQM AIT Flow

4.1 Activities Overview

Figure 4-1 gives an overview of the tasks which are planned to be performed during the EPLM EQM AIT programme (for details see RD 1).

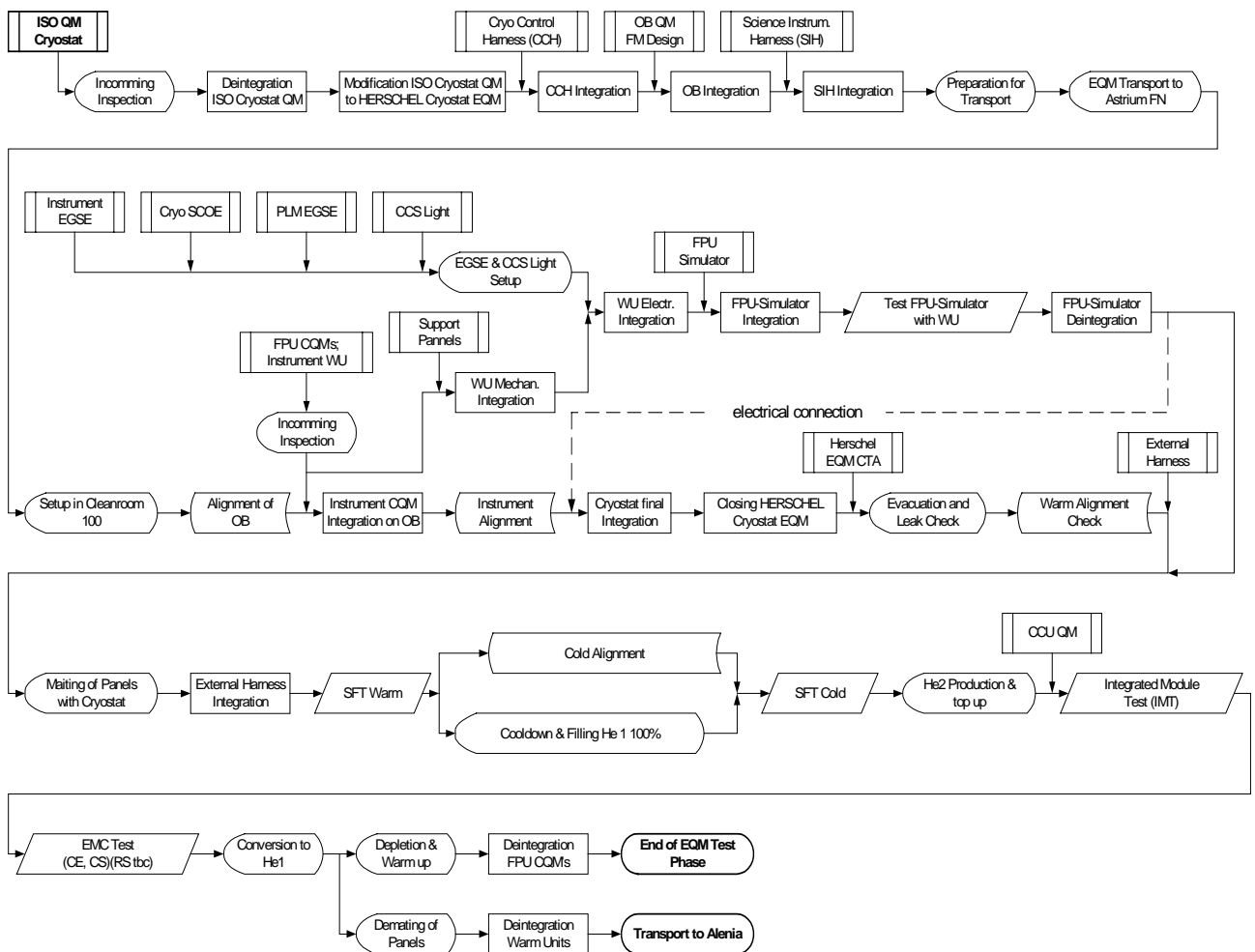

Figure 4-1: EQM AIT Flow

4.2 Instrument Specific Test Activities

4.2.1 Incoming Inspection

The incoming inspection will be performed on all instrument items to be integrated in the EPLM in order to assure their quality.

The incoming inspection covers the visual inspection of the hardware, the cleanliness control and the check of the documentation.

The following items will be verified:

Packing undamaged ?

- Seals and straps intact ?
- Correct labelling ?

Transportation container, inner packing

- Correct identification (see heading) ?
- Equipment correctly and safely packed ?
- Equipment hermetically sealed ?
- Packed with desiccants ?
- Packed with humidity-indicators ?
- Packed with shock-indicators ?
- Packed with temperature-indicators?
- Container reusable and stackable ?

Equipment

- Identification correct ?
- Screw sealing not broken ?
- Surface finish undamaged and clean ?
- Connector identification correct ?
- Connector with protective caps ?
- Connector pins clean and undamaged ?
- Mounting area clean and undamaged ?
- Accessories, bonding points, covers ?

Documentation

- Shipping documentation ?
- Log sheets / historical records ?

- Handling, packing, transport procedures ?
- End Item Data Package (ICD) ?
- Other Documentation

Other notable defects ?

4.2.2 Instrument EGSE Validation

The Instrument EGSE validation will comprise a stand-alone test of the Instrument EGSE (self-test).

Secondly, after connection to the CCS lite, an interface check will be performed (PIPE protocol).

Its objective is to check the proper electrical EGSE – CCS connections and the correct functioning of the EGSE – CCS interface drivers.

Note: This test does not substitute the principle verification of the Instrument EGSE – CCS interface which is part of the Instrument EGSE and CCS AIT programme.

For specific check-out equipment (e. g. HIFI test signal source) dedicated validation tests will be performed, as required.

4.2.3 Electrical Integration Test

The instrument electrical integration test comprises the check of

- The warm units internal interconnections.
- The connection of the warm units to the CDMU (FE).
- The connection between the FPU/LOU and the warm units.

The warm units internal interconnections and the connection of the warm units to the CDMU FE will be checked in their entity per instrument after their integration on the dummy SVM, using the instrument provided external FPU simulators (HIFI, SPIRE) or built-in (PACS) FPU simulators. The check consists of an instrument functional test TBD by HIFI/PACS/SPIRE. The FPU simulators will be connected to the warm units with the instrument provided test harness. Prior to connection with the warm units the CDMU FE lines will be electrically checked (voltages).

Note: The warm units internal interconnections will not be separately checked, since they have already been checked at instrument level with the same harness as used at EPLM level.

The check of the connection between the FPU/LOU and the warm units includes the following steps.

1. Connection of cryoharness to the warm units (HIFI and PACS) or to the FPU (SPIRE).
2. Measurement of grounding, shielding and isolation via the cryoharness versus the warm units (HIFI and PACS) or versus the FPU (SPIRE). The instrument is not powered.
3. Connection of cryoharness to the FPU simulator and verification of the instrument functional performance (HIFI only).

4. Instrument switch-off and removal of the FPU simulator (HIFI only).
5. Connection of cryoharness to the FPU/LOU (HIFI and PACS) or to the warm units (SPIRE).

For all electrical integration tests the instruments are controlled/monitored by the CCS (TBD).

The functional performance test to be performed in step 3 is TBD by HIFI.

Prior to the instrument electrical integration test the cryoharness will be separately checked in the following way:

1. Check of the cryoharness electrical design versus the instrument test harness.
This check will be performed by automatic pin-to-pin measurements of the instrument test harness and the cryoharness and an automatic comparison of the measurement results (consistency check). This will be accomplished by a computer supported data acquisition system (IDAS) using the cryoharness manufacturing database. The measurement of the test harness versus the database will be performed prior to the start of the cryoharness manufacturing (as far as possible) in order to detect potential database errors.
2. Continuity check of the integrated cryoharness.
Straight before connecting the cryoharness to instrument FPU/LOU and/or warm units a continuity check of integrated cryoharness will be done. The objective is to detect potential broken lines, short circuits or incorrect plug-and-socket connection (at SVM connector bracket, CVV feed through or instrument units),

Note: Measurements of electrical characteristics of FPU/LOU or warm units input/output lines are not planned.

4.2.4 Alignment Check

The main objectives of the alignment checks are:

- Validation of the instrument alignment procedure.
- Determination of the impact of the CVV pressure change and cool down on the instrument alignment.
- Alignment of HIFI LOU versus HIFI FPU.

The determination of the shift and rotation of the OB after cryostat evacuation and cool down will be performed in two steps. The first alignment check will be performed after the evacuation in order to quantify potential displacements due to evacuation. The second alignment check will be performed after the cool down, during the re-adjustment of the tank straps.

The shift and rotation will be determined by measurements of HIFI FPU alignment versus the HIFI LOU with a dedicated alignment camera system.

The alignment camera system consists of two alignment cameras which are mounted on the LOU, allowing to monitor simultaneously shift and rotation (two cameras are needed to determine the rotation about the y axis). A distance measurement in y direction is also possible, however, with reduced accuracy (TBC).

The correct alignment of the HIFI LOU versus HIFI FPU is required to allow reasonable instrument functional performance verification.

Note: To support these measurements the instruments FPU CQM must be equipped with alignment references equal to the FPU PFM.

4.2.5 Short Functional Test (SFT)

The principle objective of the SFT is the check of the electrical integrity and operability (command and control) of the EPLM. As regards the instruments the SFT covers the instrument switch-on and the functional verification of the electrical instrument interfaces.

The SFT does not require any specific EPLM configuration/condition (e. g. cryostat orientation) or specific instrument GSE. The test duration is in the range of 1 hour per instrument. The test evaluation is based on housekeeping data, i. e. no need of science data evaluation.

Three different types of SFT's exist, one per the major tank temperature conditions:

- SFT warm (tank without helium)
- SFT cold He1 (tank with normal boiling helium)
- SFT cold He2 (tank with supra fluid helium).

The related instrument SFT procedures are adapted to these specific thermal environmental conditions for the FPU's.

4.2.6 Specific Performance Test (SPT)

Objective of the SPT is to verify dedicated aspects of the instruments performance. This may require a specific spacecraft configuration.

I. e. SPT's are a tools to verify the instrument performance on EPLM level. The tests are strongly based on the instrument level tests in order to allow a quick and reliable performance assessment by comparing the EPLM level test results with the instrument level test results (no degradation with respect to instrument level test results, assuming that the environmental conditions are similar).

The SPT's will be conducted with in-orbit representative thermal conditions inside the cryostat and as regards the detector back ground. This will be achieved by specific cryogenic means (e. g. cryo cover as described in RD 2).

The following SPT's are defined per instrument (see also section 8.8 of this document):

HIFI

- IF Properties Test
- Radiometry Test
- Reduced Standing Wave Test ¹⁾

PACS

- Cooler Recycle / Hold Time
- Full Functional Test
- Short Performance Test ²⁾
- Astronomical Observation Template (AOT) Tests
- PACS/SPIRE Parallel Mode Test

SPIRE

- Cooler Recycle / Hold Time
- Ambient Background Verification Test
- Photometer Mode Thermal Balance Test
- PACS/SPIRE Parallel Mode Test

¹⁾ The test comprises the impact verification of the standing waves on the LO path between LOU and FPU.

²⁾ It would be preferred to break down the Short Performance Test into its different subsets (e. g. with the cooler recycle one of them) (break down TBD by PACS).

The SPT's of the PACS and SPIRE instrument include the verification of the hold time of the 300 mK cooler.

Test details TBD by HIFI/PACS/SPIRE.

Note: In the PLM EQM AIT programme the SFT's will be merged in the IMT.

4.2.7 Integrated Module Test (IMT)

The superior objective of the IMT is the verification of the correct operation of the fully integrated EPLM in a series of representative mission modes. This includes the verification of the functional performance of the integrated instruments and their measurement performance, as far as it is possible on that level.

On PLM EQM level only one IMT is planned. This IMT will comprise instrument SFT's and specific operational scenarios to determine the related temperature transients (TBD by HIFI/PACS/SPIRE).

Figure 4-2 shows the activities to be performed during the IMT.

IMT Flow (EQM)						
Step	HIFI	PACS	SPIRE	PLM Position	Duration	Remarks
1	Off	Off	Off	No requirement	-	
2	SFT Cold He2	Stand-By	Stand-By	No requirement	1 h	SFT
3	IF Properties Test	Stand-By	Stand-By	No requirement	1 h	
4	Radiometry Test				1 day	SPT
5	Reduced Standing Wave Test	Stand-By	Stand-By	No requirement	1 day	SPT
6	Stand-By	Stand-By	SFT Cold He2	No requirement	1 h	SFT
7	Stand-By	Stand-By	Instrument Cold Functional Test	No requirement	6 h	
8	Stand-By	Stand-By	Cooler Recycle	20° to +y	3 h	
9	Stand-By	Stand-By	Ambient Background Verification Test	No requirement	1 h	SPT
10	Stand-By	Stand-By	Photometer Mode Thermal Balance Test	No requirement	2 - 3 h	SPT
11	Stand-By	SFT Cold He2	Stand-By	No requirement	TBD	SFT
12	Stand-By	PACS Cooler Recycle	Stand-By	20° to +y	3 h	
13	Stand-By	PACS/SPIRE Parallel Mode	PACS/SPIRE Parallel Mode	No requirement	TBD	
14	Stand-By	Short Functional Test	Wait for Cooler Exhaustion	No requirement	TBD	SPT
15	Stand-By	AOT Tests	Wait for Cooler Exhaustion	No requirement	TBD	SPT
16	Stand-By	Wait for Cooler Exhaustion	Wait for Cooler Exhaustion	No requirement	TBD	SPT
17	Specific Operational Switch-On Scenarios			No requirement	TBD	TBD by HIFI/PACS/SPIRE
18	Off	Off	Off	No requirement	-	

Figure 4-2: IMT Activity Flow (proposal TBC by HIFI/PACS/SPIRE)

The IMT includes the verification of the hold time of the 300 mK cooler, i. e. in the IMT a full cooler recycle period is foreseen for PACS and SPIRE

During the IMT the constraints of the EPLM tilting angle during PACS and SPIRE cooler recycles will be considered.

An in-orbit representative thermal background will be achieved by specific cryogenic means which are described in RD 2.

Note: Test breakdowns/details TBD by HIFI/PACS/SPIRE.

4.2.8 EMC Test

The general objective of the instrument EPLM EQM level EMC test programme is to demonstrate that the instruments are compatible with the Herschel EPLM electro-magnetic environment.

The EMC tests comprise measurements of the conducted emission and susceptibility, both in common and differential mode, and a specific radiated susceptibility test.

During the conducted emission measurements the instruments are switched in a mode with maximum generation of electrical distortion on the electrical lines. During the conducted and radiated susceptibility test the instruments are switched in a mode with highest sensitivity to electromagnetic distortions.

The instruments will be tested individually, i. e. the EMC test configurations and sweeps will be repeated for each instrument.

Prior to the EMC tests a reference test will be made to determine the performance under nominal conditions.

An in-orbit representative thermal background will be achieved by specific cryogenic means which are described in RD 2.

The EQM EMC tests will be performed in a standard integration facility at Astrium (i. e. no anechoic chamber).

During the EMC test the constraints of the EPLM tilting angle during PACS and SPIRE cooler recycles will be considered.

Figure 4-3 describes the instrument tests and modes to be performed within the EMC test.

EMC Test Flow (EQM)						
Step	Test Type	HIFI	PACS	SPIRE	PLM Position	Duration
1	-	Off	Off	Off	No requirement	-
2	Reference test	Measurement Mode (Band 3 H)	Stand-By	Stand-By	No requirement	2 days (TBC)
3	Reference test	Measurement Mode (Band 3 V)	Stand-By	Stand-By	No requirement	
4	CE	Measurement Mode (most noisiest)	Stand-By	Stand-By	No requirement	
5	CS	Measurement Mode (Band 3 H)	Stand-By	Stand-By	No requirement	
6	CS	Measurement Mode (Band 3 V)	Stand-By	Stand-By	No requirement	
7	RS	Measurement Mode (Band 3 H)	Stand-By	Stand-By	No requirement	
8	RS	Measurement Mode (Band 3 V)	Stand-By	Stand-By	No requirement	
9	-	Stand-By	Cooler Recycle	Stand-By	20° to +y	
10	Reference test	Stand-By	TBD (most sensitive mode)	Stand-By	No requirement	
11	CE	Stand-By	TBD (most noisiest mode)	Stand-By	No requirement	
12	CS	Stand-By	TBD (most sensitive mode)	Stand-By	No requirement	
13	RS	Stand-By	TBD (most sensitive mode)	Stand-By	No requirement	
14	-	Stand-By	Stand-By	Cooler Recycle	20° to +y	2 days (TBC)
15	Reference test	Stand-By	Stand-By	TBD (most sensitive mode)	No requirement	
16	CE	Stand-By	Stand-By	TBD (most noisiest mode)	No requirement	
17	CS	Stand-By	Stand-By	TBD (most sensitive mode)	No requirement	
18	RS	Stand-By	Stand-By	TBD (most sensitive mode)	No requirement	
19	-	Off	Off	Off	No requirement	-

Note: Most sensitive/noisiest modes during EMC tests TBD by HIFI/PACS/SPIRE.

Figure 4-3: EMC Test Activities Flow

In the following the test flow is depicted in more detail:

Principle emission test sequence

- Powering of instrument
- Commanding of instrument into most noisiest mode
- HK data monitoring

Principle susceptibility test sequence

- Powering of instrument
- Commanding of instrument into most sensitive mode
- Application of instrument stimuli if necessary (TBD by HIFI/PACS/SPIRE)
- HK data monitoring

- Analysis of the scientific data (quick look).

The following primary and secondary power lines will be considered during conducted emission and susceptibility tests (tests on primary power lines might not be useful, since not flight representative on PLM level):

HIFI:

- TBD by HIFI

PACS

- TBD by PACS

SPIRE

- TBD by SPIRE

The following parameters are monitored during the susceptibility tests:

HIFI:

- TBD by HIFI

PACS

- TBD by PACS

SPIRE

- TBD by SPIRE

Note:

The satellite housekeeping data is sampled on-board every 1 second but transmitted only every 4 seconds. Therefore, instead of continuous sweeping a step-wise frequency adjustment will be applied for susceptibility testing. A minimum exposure time of 8 seconds is recommended for each frequency step. The data transmission sampling rate could be increased to 1 Hz for single parameters, on the expense of the number of parameters which can be monitored. Therefore, an increase of the sampling rate will be considered only for those parameters, which already showed susceptibility during unit level

test. Such specific parameters together with the frequency bands where susceptibility exists are TBD by HIFI,/PACS/SPIRE.

Warning:

The instrument interconnection harness shall not have any open lines, i. e. lines which are specified in the IID-B but which not used for the instrument EQM (e. g. due to missing redundancies, etc.) shall be properly terminated inside the affected units.

5 Instrument Configurations

5.1 Instrument Hardware Configuration

5.1.1 HIFI EQM Configuration

The delivered HIFI instrument hardware for the EPLM EQM programme is configured as per Table 5-1. In addition this table indicates the unit test histories prior to shipment to ESA.

Unit	Built Standard	Unit ID	Form	Fit	Function	EMC	TC/TV	Vibration
FPU	QM	FH-FPU-QM	FM	FM	Only band 3 active ²⁾	Yes	Yes	Yes
FCU	DM	FH-FCU-DM-2	FM	FM	No redundancy	Yes	No	No
LOU	QM	FH-LOU-QM	¹⁾	FM	Only band 3	Yes	Yes	Yes
LCU	DM	FH-LCU-DM	FM	FM	No redundancy	Yes	No	No
LSU	DM	FH-LSU-DM	FM	FM	No redundancy	Yes	No	No
WEH	QM	FH-WEH-QM	FM	FM	FM	Yes	Yes	Yes
WEV	Not delivered							
WOH	QM	FH-WHO-QM	FM	FM	FM	Yes	Yes	Yes
WOV	Not delivered							
HRH	QM	FH-HRH-QM	FM	FM	FM	Yes	Yes	Yes
HRV	Not delivered							
ICU	QM	FH-ICU-QM	FM	FM	No redundancy	Yes	Yes	Yes

¹⁾ LOU consists of 1 LOA (band 3a/3b) plus connectors of the 6 other LOA's on appropriate brackets plus penta prisms, all mounted on a dummy base plate with flight representative interface to the CVV side support plate.

²⁾ The FPU QM contains heaters to simulate the FPU thermal load.

Table 5-1: HIFI EQM Hardware Built Standards

5.1.2 PACS EQM Configuration

The delivered PACS instrument hardware for the EPLM EQM programme is configured as per Table 5-2.

Unit	Form	Fit	Function	Redundance	Remark
DPU	FM	FM	FM	No redundancy foreseen for AVM	PFM fully redundant
SPU	Delivered as rack, mountable on SVM TBC	FM	FM	No redundancy foreseen for AVM	PFM fully redundant
DECMEC	Delivered as rack, mountable on SVM TBC	FM	FM	No redundancy foreseen for AVM	PFM partially redundant
BOLC	Delivered as rack, mountable on SVM TBC	FM	Delivered without power supply	No redundancy foreseen for AVM	PFM partially redundant
WIH	FM	FM	FM	N.A.	Identical with PFM harness; back shells to be discussed
FPU	FM	FM	Full optics. All mechanisms complete. Both photo-conductor arrays working, but only 2x12 modules integrated instead of 2x25.	Same redundancy as PFM	PFM subunits partially redundant

Unit	Form	Fit	Function	Redundance	Remark
			Both bolometer arrays completely equipped, but only 50% in each array with full IR performance.		

Table 5-2: PACS EQM Hardware Built Standards

5.1.3 SPIRE EQM Configuration

The delivered SPIRE instrument hardware for the EPLM EQM programme is configured as per Table 5-3.

Unit: HSFPU

Subsystem/Component	Delivered CQM Form/Capability
Structure/baffles/wiring standoffs etc	Flight representative
Mirrors	Flight representative
Filters	Flight representative
Beam steering mirror	Form and fit compliant Functionally representative in at least one axis No redundancy Electrical interfaces compliant Thermal conduction flight representative Thermal dissipation may not be flight representative
³ He fridge/thermal straps	Form and fit compliant Functionally fully flight representative All parts flight build standard except thermometers and heaters will be commercial/industrial grade
300 mK Thermal control system	None
Photometer LW array	Flight representative
Photometer MW array	Form and fit compliant Resistors used to represent detectors. Temperature monitors functionally representative (TBC)
Photometer SW array	Ditto
SMEC	Form and fit compliant Functionally representative – mirror travel TBD Electrical interfaces must be compliant Thermal conduction flight representative

Subsystem/Component	Delivered CQM Form/Capability
	Thermal dissipation may not be flight representative
Spectrometer SW array	As P/MW and P/SW arrays
Photometer LW array	Flight representative
Photometer calibrator	Form and fit compliant Functionally representative Electrical interfaces compliant Thermal interfaces compliant No redundancy (TBC)
Spectrometer calibrator	Form and fit compliant Functionally representative Electrical interfaces compliant Thermal interfaces compliant No redundancy (TBC)
Shutter	Form and fit compliant Functionally representative Electrical interfaces compliant
JFET Enclosures	Flight representative
JFET modules and JFET box RF filter modules	Form and fit compliant Functionally representative Electrical interfaces compliant Thermal interfaces compliant Only JFETs for "live" detector channels will be provided Resistors for thermal dissipation in other channels will be provided (TBC)
FPU RF filters	Flight representative
Thermometry	Flight representative
FPU internal harnesses	Flight representative
Harnesses between FPU-JFET (photometer) and FPU-JFET (spectrometer)	TBC

Unit: HSDCU

Subsystem/Component	Delivered CQM Form/Capability
External structure/mechanical interfaces	Flight representative
Electrical interfaces	Prime interfaces flight representative No redundant interfaces implemented
Functionality	Near flight performance on prime side No redundant side implemented
Electrical component level	Commercial/industrial level parts with near flight performance

Unit: HSFCU

Subsystem/Component	Delivered CQM Form/Capability
External structure/mechanical interfaces	Form and fit compliant but additional bench power supply that will be separate from this unit.
Electrical interfaces	Prime interfaces flight representative No redundant interfaces implemented
Functionality	Near flight performance on prime side No redundant side implemented
Electrical component level	Commercial/industrial level parts with near flight performance

Unit: HSDPU (this unit will also be used for the AVM)

Subsystem/Component	Delivered CQM Form/Capability
External structure/mechanical interfaces	Flight representative
Electrical Interfaces	Prime interfaces flight representative No redundant interfaces implemented
Functionality	Near flight performance on prime side No redundant side implemented
Electrical component level	Commercial/industrial level parts with near flight performance

Unit: HSWIH (warm interconnect harness)

Subsystem/Component	Delivered CQM Form/Capability
External structure/mechanical interfaces	Flight representative
Electrical Interfaces	Flight representative
Functionality	Near flight performance
Electrical component level	Commercial/industrial level parts with near flight performance

Table 5-3: SPIRE EQM Hardware Built Standards

5.2 Instrument GSE Configuration

5.2.1 Instrument EGSE Configuration

The delivered Instrument EGSE for the EPLM EQM programme is as per Table 5-4.

Instrument	GSE	Remarks
HIFI/PACS/SPIRE	2 Instrument EGSE Stations for all 3 instruments	One operated in real time, the other as backup or for post processing tasks
HIFI	FPU simulator	For electrical integration test
HIFI	CW test signal source with LO beam splitter	For EMC test Equipment will be located between LOU and CVV windows (LOU chain 3 beam)

Table 5-4: Instrument EGSE Items

The Instrument EGSE Station is composed by the following items:

- SCOS workstation – used primarily to run the SCOS-2000 software. This will be a PC running Linux with a dual display card driving two displays.
- Analysis workstation – used to run the instrument analysis software (QLA/IA/PCSS). This will be a PC running Linux with a dual display card driving two displays.
- Data Server – used primarily to run the HCSS software. This will be a PC running Linux with a single display and large disk drives with backup facility (to tape/CD TBD).
- Colour laser printer.
- LAN switch - protects the Operational System from the Analysis System allowing access to the external internet from the Analysis System.
- Laptops – used to run instrument specific analysis tools. These are not provided as part of the EGSE but may be used by instrument experts as necessary during testing.

5.2.2 Instrument MGSE Configuration

All instrument hardware will be delivered in appropriate containers including shock indicators, temperature monitoring as well as cleanliness provisions. For each FPU and the HIFI LOU appropriate lifting devices will be delivered with the units. Details TBD by HIFI, PACS and SPIRE.

5.3 Instrument Documentation

5.3.1 EIDP

For each instrument an EIDP will be provided.

5.3.2 Test Sequences

The instrument test procedures to be applied on EPLM level is a subset of the instrument level test procedures. They will be delivered by the instruments in CCS TOPE compatible format and include all telecommands to control and monitor the instruments during testing.

For EPLM level purposes these procedures will be appropriately embedded in the EPLM test procedures. A specific validation of the instrument provided test procedures is not planned.

The following test procedures will be delivered:

HIFI:

- TBD by HIFI

PACS

- TBD by PACS

SPIRE

- TBD by SPIRE

6 Test Set-up

6.1 Principle EPLM Test Set-up

The principle EPLM EQM test set-up is shown in Figure 6-1. It consists of the EPLM EQM equipped with the 3 instrument FPU CQM's and a SVM dummy structure with the integrated instrument warm units AVM's and the EGSE. The EGSE of the CCS "light" which serves as core, the PLM EGSE with data- and power front ends which provide flight representative interfaces to the instruments, the Cryo SCOE to control the cryostat and the Instrument EGSE. The Instrument EGSE consists of 1 nominal EGSE and 1 back-up EGSE. The Instrument EGSE is common for all instruments.

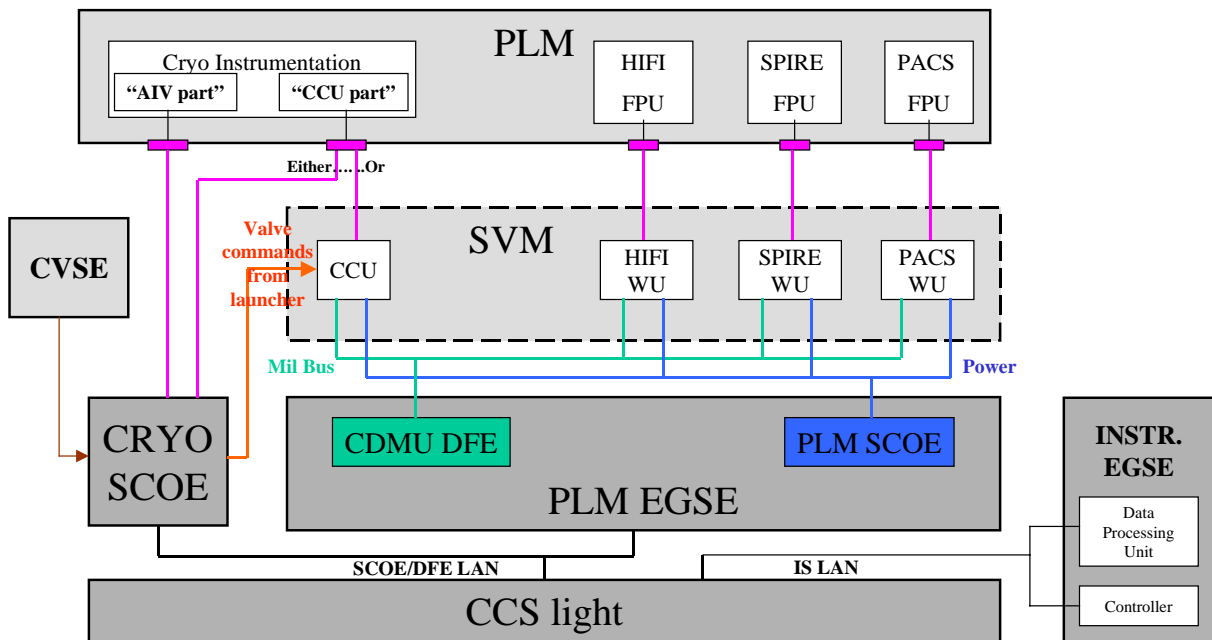

Figure 6-1: Principle Test Set-up for EQM Tests

Figure 6-2 shows the Instrument EGSE block diagram and provides an overview of the interface to the CCS.

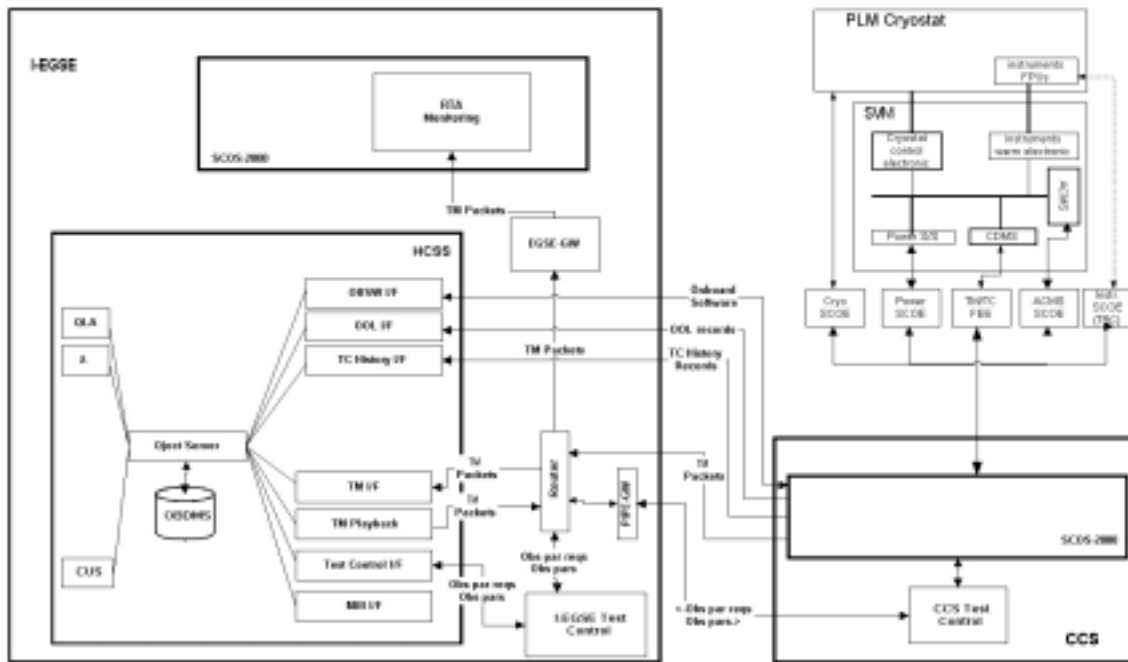

Figure 6-2: Data Exchange during EPLM EQM Test

All EPLM level instrument tests will be executed from the CCS light re-using a subset of instrument level test procedures.

The CCS interfaces to the Instrument EGSE using the PIPE protocol (for details see RD 3). The database is physically located in the IEGSE (HCSS).

Access to the Instrument EGSE via internet is only foreseen for monitoring (no commanding) and will be provided by the Instrument EGSE itself. Online transfer of recorded data is possible e. g. by FTP.

FPU simulators and other instrument specific test equipment (e.g. HIFI stimuli equipment) have no interface to the CCS. I. e. such equipment will be controlled off-line.

Control of HIFI FPU simulator and CW test signal source TBD by HIFI.

6.2 Test Facility

The tests (incl. EMC test) will take place in a cleanroom class 100 000 in a test facility at Astrium (Ottobrunn). The layout of the test facilities is shown in Figure 6-3. For details see AD 06.

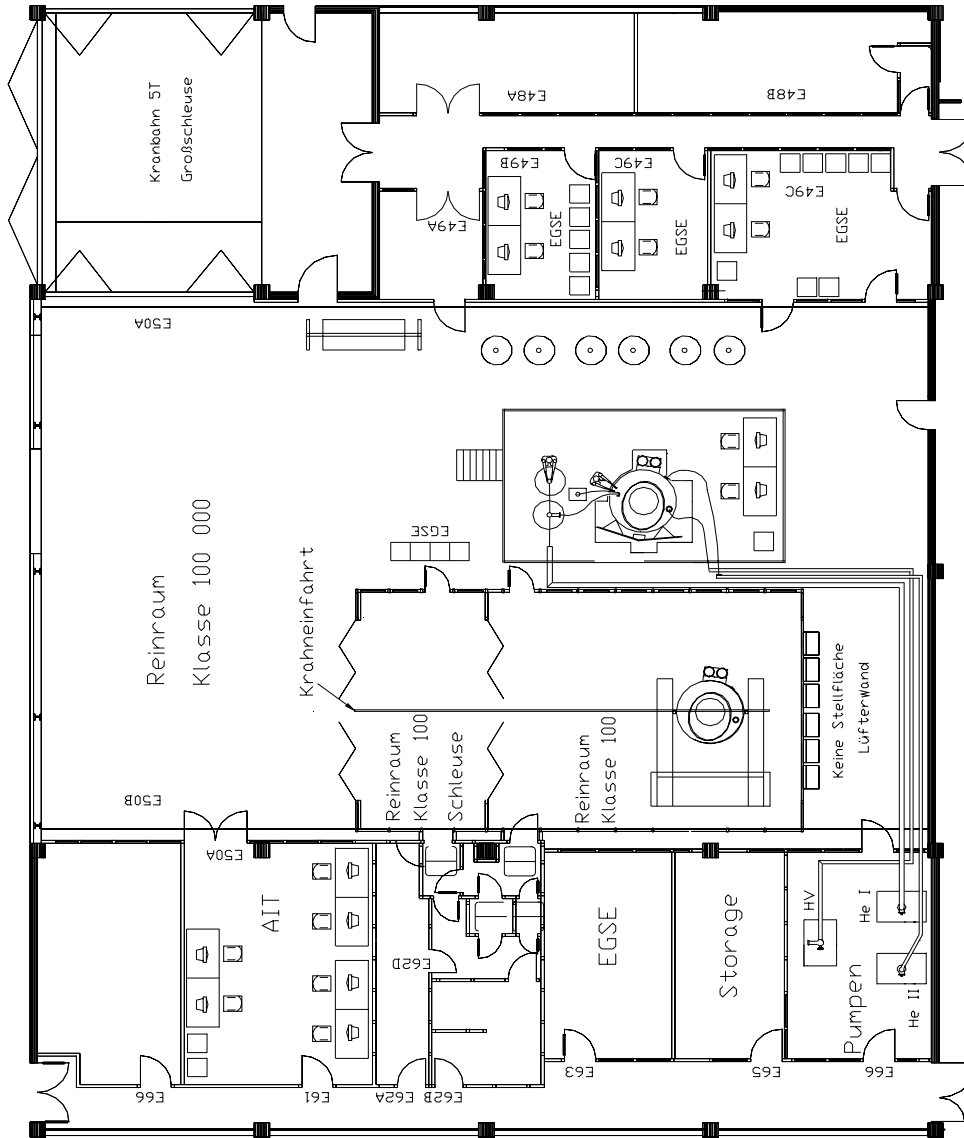

Figure 6-3: Layout of Test Facility

7 Instrument Specific Test Conditions and Constraints

7.1 Instrument Test Durations

In the following tables the nominal duration of the instrument test sequences are listed.

HIFI

Test	Duration	Remark
HIFI Incoming inspection	1 day	
HIFI EGSE Check out	1 h	
HIFI Electrical Interface Test	2 days	
HIFI Alignment Test	2 days	
HIFI SFT Warm	1 h	
HIFI SFT Cold He1	1 h	
HIFI SFT Cold He2	1 h	
HIFI IF properties	1 h	
HIFI Radiometry	1 day	
HIFI Recuded Standing Wave Test	1 day	
HIFI Integrated Module Test	3 days (TBC)	
HIFI EMC Test	2 day (TBC)	

Note: In all cases the related test sequences have not been produced and tested.

Table 7-1: HIFI Test Duration

PACS

TBD by PACS

Table 7-2: PACS Test Duration

SPIRE

Test	Duration	Remark
SPIRE Incoming inspection	1 day	
SPIRE EGSE Check out	-	Common EGSE
SPIRE Electrical Interface Test	TBD	
SPIRE SFT Warm	1 h	
SPIRE Short Functional Test Cold He1	1 h	
SPIRE Short Functional Test Cold He2	1 h	Test identical to SFT Cold He1
SPIRE Cold Functional Test	6 h	
SPIRE Cooler Recycle Stand Alone Test	3 day	
SPIRE Ambient Background Verification Test	1 h	
Photometer Mode Thermal Balance Test	2 – 3 h	
SPIRE Integrated Module Test	2 days (TBC)	Full cooler cycle
SPIRE EMC Test	2 days (TBC)	

Table 7-3: SPIRE Test Duration

7.2 FPU/LOU Operational Constraints

This chapter defines the operational restrictions, constraints and limitations as regards the FPU /LOU operation which have to be respected during their integration and tests at EPLM EQM level.

HIFI

The FPU QM contains heaters to simulate the FPU thermal load. These heaters will be powered from a separate power supply (not part of the FCU) via the cryoharness using a break-out box. The break-out box and the power-supply will be delivered by HIFI. Details (location of break-out, operational aspects, EMC aspects, etc.) are TBD by HIFI and to be agreed with ASED.

For the SFT's the FPU might be in ambient conditions. During the IMT and the EMC test the following temperature requirements apply: L0 < 2 K, L1 < 6 K, L2 < 20 K.

Other operational constraints, if any, TBD by HIFI.

PACS

The following FPU temperature constraints exist:

IID-B specified operating temperatures are required for the following tests

- Achieve data as regards EMC sensitivity.
- Performance evaluation of bolometers and photometers.
- Calibration purposes using the built in calibration sources.
- Cooler recycling.

For small exceedings (< 1 K) the following tests are possible

- Operation of blue detectors (photometers).
- Verification of mechanisms.

Impacts: reduction of He3-cooler hold-time.

For considerable exceedings (2K-5K) the possible tests are limited to

- Verification of mechanisms.
- Verification of read out electronic.

Impacts: Detector signals are in overload.

For exceedings > 5K only continuity checks are possible.

For the recording of one set of bolometer parameters the minimum required hold time of the sorption cooler is 6 h.

SPIRE

TBD by SPIRE.

7.3 Spacecraft Orientation

The following spacecraft orientations will exist:

- 0 deg for all tests excluding PACS and SPIRE cooler recycling.
- 20 deg +/- TBD deg in +y-direction during (duration about 2 h) PACS and SPIRE cooler recycling.
- All orientations between +/- 90 deg during integration activities and SFT warm (TBC).

7.4 Sensor Background

The EPLM EQM cryostat will provide far infrared background radiation levels for PACS and SPIRE comparable to those induced by the telescope. For HIFI no specific measures for that aspect have been implemented.

This will be accomplished by a specific design of cold plates (mirrors) which perform self-imaging of the PACS and SPIRE FPU entrance holes. Other contributions of thermal radiation are highly suppressed. The mirror temperature is 80 K (adjustable to in-orbit telescope temperature by control of LN2/LHe flow). The mirror emissivity is 0.04 (corresponding to the total telescope emissivity). For details see RD 2.

7.5 Thermal Environment

The L0, L1 and L2 temperature levels provided by the EQM cryostat (ISO) at the FPU thermal links are listed in Table 7-4. They are practically flight representative. The given ranges are valid for the corresponding instrument in operation. For details see RD 4.

	HIFI		PACS		SPIRE	
	min [K]	max [K]	min [K]	max	min [K]	max
At He1 conditions	L0: 4.2 L1: L2:	L0: L1: L2:	L0: 4.2 L1: 4.2 L2:	L0: L1: L2:	L0: 4.2 L1: L2:	L0: L1: L2:
At He2 conditions	L0: 1.7 L1: 1.7 L2: 9.0	L0: 3.0 L1: 10.0 L2: 15.0	L0: 1.7 L1: 1.7 L2: 9.0	L0: 3.0 L1: 6.0 L2: 15.0	L0: 1.7 L1: 1.7 L2: 9.0	L0: 3.0 L1: 8.0 L2: 15.0

Table 7-4: Interface Temperatures provided by the EQM Cryostat (all values TBC)

7.6 Cleanliness

The following specific cleanliness provisions will be applied:

HIFI LOU

The LOU windows will be protected against particles > 20 µm conductive material by covering the openings with TBD tape during the entire EPLM EQM AIT programme with the exception for the following HIFI tests: TBD by HIFI (TBC).

7.7 Purging

During the EPLM EQM AIT no purging will be provided.

7.8 ESD Procedures

Instruments will be electrically integrated following the relevant ESA standards.

Specific constraints TBD by HIFI/PACS/SPIRE.

7.9 Microvibration

This chapter defines restrictions as regards microvibrations during instrument performance tests at EPLM EQM level.

Specific constraints TBD by HIFI/PACS/SPIRE.

7.10 Integration

This chapter defines specific procedures or precautions which will be considered during the instrument integration.

HIFI

For HIFI the specific following integration flow applies:

1. Delivery of FPU with FPU simulator and the FCU plus the required SCOE.
2. Electrical integration check and "reduced" SFT warm.
During the electrical integration check and the "reduced" SFT warm the FCU which will be controlled by the SCOE (off-line).
3. Delivery of LOU with LOU simulator (TBC by HIFI) and the LCU/LSU plus the required SCOE (TBC by HIFI).
The electrical integration check will be performed with the LOU simulator (TBC by HIFI). The LCU/LSU will be controlled by the SCOE (off-line).
4. Delivery of remaining warm units.

The procedures for the off-line control of the SCOE's TBD by HIFI.

The EQM specific "reduced" alignment between FPU, optical windows and LOU and between FPU and cryostat is described in RD 5.

Other specific procedures or precautions TBD by HIFI.

PACS

Specific procedures or precautions TBD by PACS.

SPIRE

The following points will be considered when fitting or removing the SPIRE FPU to the optical bench:

Probably before reconsidering the SPIRE FPU integration the SPIRE team should first decide if the FPU must be fitted/removed with the JFETS in place, as that will certainly affect the lifting gear design.

We understand that because access to the front (conical) fixed mounting of the FPU is difficult with the FPU in position, the fixed mount will be attached to the HOB before the FPU. This means that when lowering the FPU into position, great care must be taken to ensure that the FPU base is parallel to the

HOB so that the dowel spigot on the top of the fixed mount is accurately aligned with the mating hole at the front of the FPU Optical Bench as they engage. This need for alignment is more of a worry if the FPU is removed from the HOB, as if the FPU is not lifted parallel to the HOB the fixed mounting dowel spigot will certainly seize in the FPU Optical Bench and damage both parts.

It is for the above reason that the current MSSSL SPIRE handling gear has jacking screws to carefully level, raise and lower the FPU over the fixed mount. We accept that it will not be possible to use the existing gear when integrating the FPU to the HOB due to clashes with the vent lines etc. but I feel there must be some means of carefully controlling the FPU alignment during this process. Maybe an alternative jacking or levelling system can be devised between us to do this.

The rear FPU "A" frame mounts will be fitted to the FPU before it is lowered onto the HOB. Given the fragility of these mounts when subjected to any out of plane loads, together with the suspended mass of the FPU and lifting gear, any slight swing which leads to the "A" frames contacting something while suspended is almost certain to damage the "A" frames. Great care must therefore be exercised to prevent the "A" frames making contact with anything while the FPU is suspended, and a gentle touch down on the HOB is vital.

In principle I have nothing against the fish plate lifting scheme proposed by ASSED, so long as the above requirements are met and the FPU hangs level.

The FPU end of the Level"0" straps (i. e. where they enter the FPU) must be fitted before the FPU is integrated to the HOB. This is because it is a difficult procedure and they mate to fragile parts on Kevlar suspensions. The rigid parts of the level "0" straps could be fitted after FPU installation to the HOB if required, so long as access to each of the three bolt joints shown on the ICD is possible.

The MSSSL preference, however, would be to install the straps as shown on the SPIRE FPU interface drawing, probably with temporary lower supports to prevent them swinging around. Once the FPU is in position on the HOB the temporary lower supports would be removed.

TBC.

8 Instrument Test Activity Descriptions

This sections describes the individual test activities per instrument which will be performed on EPLM EQM level. Each test activity is self-contained.

The objectives of the tests are as per section 3.2.

For each single test activity a dedicated test procedure will be established per unit and/or subsystem to be tested, as far as applicable.

For the EPLM EQM level tests the test procedures developed for and validated at the instrument level tests will be re-used with no or minimal modifications.

Test activity descriptions to be made compliant to the SFT, SPT, IMT and EMC test definitions given before and to be updated according to the agreements made at the AIT meetings by HIFI/PACS/SPIRE.

8.1 Incoming Inspection

8.1.1 HIFI Incoming Inspection

Title:
Incoming Inspection

Experiment:
HIFI

Objectives:
Visual inspection of the delivered instrument for damage. Check of completeness of hardware items and documentation.

Test Description:
Check each unit on shipment notification, complete and correct documentation, visual inspection of damage of transport container (prior to unpacking) and damage and cleanliness of unit,

Instrument Configuration:
The delivered units are as per Table 5-1.
Probably three separate shipments: 1) FPU, 2) LOU and 3) warm units plus IEGSE.

Specific Requirements on EPLM:
N/A

Particular Environmental Constraints:
Clean room, class 100 for FPU, class 100.000 or better for other units. ESD certified area. Relative humidity > 40 % and < 55 %.

Success Criteria:
Documents complete and correct, no damage on delivered hardware.

Duration:
1 day

Applicable:
EPLM EQM

8.1.2 PACS Incoming Inspection

Title:

Incoming Inspection

Experiment:

PACS

Objectives:

Visual inspection of the delivered instrument for damage. Check of completeness of hardware items and documentation.

Test Description:

Check each unit on shipment notification, complete and correct documentation, visual inspection of damage of transport container (prior to unpacking) and damage and cleanliness of unit,

Instrument Configuration:

The delivered units are as per Table 5-2, packed in separate transport boxes (TBC).

Specific Requirements on EPLM:

N/A

Particular Environmental Constraints:

Clean room, class 100 for FPU, class 100.000 or better for other units. ESD certified area. Relative humidity > 40% and < 55 %.

Success Criteria:

Documents complete and correct, no damage on delivered hardware.

Duration:

3 h

Applicable:

EPLM EQM

8.1.3 SPIRE Incoming Inspection

Title:

Incoming Inspection

Experiment:

SPIRE

Objectives:

Visual inspection of the delivered instrument for damage. Check of completeness of hardware items and documentation.

Test Description:

Check each unit on shipment notification, complete and correct documentation, visual inspection of damage of transport container (prior to unpacking) and damage and cleanliness of unit,

Instrument Configuration:

The delivered units are as per Table 5-3, packed in separate transport boxes (TBC).

Specific Requirements on EPLM:

N/A

Particular Environmental Constraints:

Clean room, class 100 for FPU, class 100.000 or better for other units. ESD certified area. Relative humidity > 40% and < 55 %.

Success Criteria:

Documents complete and correct, no damage on delivered hardware.

Duration:

3 h

Applicable:

EPLM EQM

8.2 Instrument EGSE Validation

8.2.1 HIFI EGSE Check Out

Title:

EGSE Check Out

Experiment:

HIFI

Objectives:

Check of Instrument EGSE function (self-test). Check of Instrument EGSE interfaces to CCS.

Test Description:

Perform self-test on instrument workstation.
Connect instrument work station to CCS via LAN.
Check connect/disconnect commands to instrument workstation.
Send TM and TC history packets to instrument workstation.
Export instrument command sequences and data base to CCS.
Load/dump OBSW files.

Instrument Configuration:

As per
Table 5-4.

Specific Requirements on EPLM:

None.

Particular Environmental Constraints:

None.

Success Criteria:

TBD

Duration:

1 day

Applicable:

EPLM EQM

8.2.2 PACS EGSE Check Out

Title:

EGSE Check Out

Experiment:

PACS

Objectives:

Check of Instrument EGSE function (self-test). Check of Instrument EGSE interfaces to CCS.

Test Description:

Perform self-test on instrument workstation.

Connect instrument work station to CCS via LAN.

Check connect/disconnect commands to instrument workstation.

Send TM and TC history packets to instrument workstation.

Export instrument command sequences and data base to CCS.

Load/dump OBSW files.

Instrument Configuration:

As per
Table 5-4.

Specific Requirements on EPLM:

None.

Particular Environmental Constraints:

None.

Success Criteria:

TBD

Duration:

1 h

Applicable:

EPLM EQM

8.2.3 SPIRE EGSE Check Out

Title:

EGSE Check Out

Experiment:

SPIRE

Objectives:

Check of Instrument EGSE function (self-test). Check of Instrument EGSE interfaces to CCS.

Test Description:

Perform self-test on instrument workstation.

Connect instrument work station to CCS via LAN.

Check connect/disconnect commands to instrument workstation.

Send TM and TC history packets to instrument workstation.

Export instrument command sequences and data base to CCS.

Load/dump OBSW files.

Instrument Configuration:

As per
Table 5-4.

Specific Requirements on EPLM:

None.

Particular Environmental Constraints:

None.

Success Criteria:

TBD

Duration:

1 h

Applicable:

EPLM EQM

8.3 Electrical Integration Test

8.3.1 HIFI Electrical Interface Test

Title:
Electrical Interface Test

Experiment:
HIFI

Objectives:
Check of grounding and shielding and input/output circuits function and characteristics.

Test Description:
Check of FCU interfaces via cryo harness with IDAS and FPU simulator.
Check of LCU interfaces via cryo harness with IDAS.

Instrument Configuration:
The units to be tested are as per Table 5-1.

Specific Requirements on EPLM:
None

Particular Environmental Constraints:
Clean room, class 100 for FPU, class 100.000 or better for other units. ESD certified area. Relative humidity > 40% and < 55 %.

Success Criteria:
Bonding, isolation and input/output circuit characteristics, resistances as per spec.

Duration:
2 days

Applicable:
EPLM EQM

8.3.2 PACS Electrical Interface Test

Title:

Electrical Interface Test

Experiment:

PACS

Objectives:

Check of grounding and shielding and input/output circuits function and characteristics.

Test Description:

Check of warm unit interfaces to FPU via cryo harness with IDAS.

Instrument Configuration:

The units to be tested are as per Table 5-2.

Specific Requirements on EPLM:

None

Particular Environmental Constraints:

Clean room, class 100 for FPU, class 100.000 or better for other units. ESD certified area. Relative humidity > 40% and < 55 %.

Success Criteria:

Bonding, isolation and input/output circuit characteristics, resistances as per spec.

Duration:

2 days

Applicable:

EPLM EQM

8.3.3 SPIRE Electrical Interface Test

Title:

Electrical Interface Test

Experiment:

SPIRE

Objectives:

Check of grounding and shielding and input/output circuits function and characteristics.

Test Description:

Check of warm unit interfaces to FPU via cryo harness with IDAS and FPU simulator.

Instrument Configuration:

The units to be tested are as per Table 5-3.

Specific Requirements on EPLM:

None

Particular Environmental Constraints:

Clean room, class 100 for FPU, class 100.000 or better for other units. ESD certified area. Relative humidity > 40% and < 55 %.

Success Criteria:

Bonding, isolation and input/output circuit characteristics, resistances as per spec.

Duration:

2 days

Applicable:

EPLM EQM

8.4 Alignment Check

8.4.1 HIFI Alignment Test

Title:

Alignment Test

Experiment:

HIFI

Objectives:

Check change in alignment of FPU and LOU after evacuation and cool down. With this check also the alignment of the optical bench with respect to the CVV is covered. Another objective is the validation of the alignment procedure (as far as possible).

Test Description:

During this test the relative alignment between the LOU and FPU will be monitored. The alignment devices located on the FPU and alignment devices installed on the LOU will be used. The alignment will be checked by an alignment camera. The alignment will be recorded prior to evacuation, after evacuation / prior to cool down and after cool down.

Instrument Configuration:

As per Table 5-1 plus dedicated (non-flight) alignment devices on LOU plus alignment camera.

Specific Requirements on EPLM:

None.

Particular Environmental Constraints:

Clean room, class 100 for FPU, class 100.000 or better for other units. ESD certified area. Relative humidity > 40% and < 55 %.

Success Criteria:

Alignment stays within the predicted error budget.

Duration:

2 days per alignment check

Applicable:

EPLM EQM

8.5 Short Functional Test Warm

8.5.1 HIFI Short Functional Test Warm

Title:

Short Functional Test Warm

Experiment:

HIFI

Objectives:

Confidence test to check electrical integrity and operability of instrument under ambient conditions for both, the FPU and the warm units prior to the evacuation of the CVV. The operability of the FPU under ambient conditions is limited, therefore the test cannot fully verify the instrument function. Evaluation will be based on housekeeping data, evaluation of science data is not foreseen.

Test Description:

Send the following commands: Power On (EPLM command), Stand-By, TBD, TBD,.... Monitor in parallel instrument power consumption (EPLM HK parameters) and instrument HK parameters.

Instrument Configuration:

As per Table 5-1 and Table 5-4.

Specific Requirements on EPLM:

None.

Particular Environmental Constraints:

Clean room, class 100 for FPU, class 100.000 or better for other units. ESD certified area. Relative humidity > 40% and < 55 %.

Success Criteria:

Housekeeping values within pre-defined limits. Correct execution of commands.

Duration:

1 h

Applicable:

EPLM EQM

8.5.2 PACS Short Functional Test Warm

Title:**Short Functional Test Warm****Experiment:****PACS****Objectives:**

Confidence test to check electrical integrity and operability of instrument under ambient conditions for both, the FPU and the warm units prior to the evacuation of the CVV. The operability of the FPU under ambient conditions is limited, therefore the test cannot fully verify the instrument function. Evaluation will be based on housekeeping data, evaluation of science data is not foreseen.

Test Description:

Send the following commands: Power On (EPLM command), Stand-By, TBD, TBD,.... Monitor in parallel instrument power consumption (EPLM HK parameters) and instrument HK parameters.

Instrument Configuration:

As per Table 5-2 and Table 5-4.

Specific Requirements on EPLM:

None.

Particular Environmental Constraints:

Clean room, class 100 for FPU, class 100.000 or better for other units. ESD certified area. Relative humidity > 40% and < 55 %.

Success Criteria:

Housekeeping values within pre-defined limits. Correct execution of commands.

Duration:

TBD h

Applicable:

EPLM EQM

8.5.3 SPIRE Short Functional Test Warm

Title:**Short Functional Test Warm****Experiment:****SPIRE****Objectives:**

Confidence test to check electrical integrity and operability of instrument under ambient conditions for both, the FPU and the warm units prior to the evacuation of the CVV. The operability of the FPU under ambient conditions is limited, therefore the test cannot fully verify the instrument function. Evaluation will be based on housekeeping data, evaluation of science data is not foreseen.

Test Description:

The S/C-instrument interfaces are checked by switch on procedure (TBD).
The instrument is placed into a state ready to receive and execute commands (READY – TBC).
Each sub-system is commanded as appropriate to verify its function (TBD).
The instrument is switched back to READY.
The instrument may be switched OFF or to another mode if further tests are planned.

Instrument Configuration:

As per Table 5-3 and
Table 5-4.

Specific Requirements on EPLM:

None.

Particular Environmental Constraints:

Clean room, class 100 for FPU, class 100.000 or better for other units. ESD certified area. Relative humidity > 40% and < 55 %.

Success Criteria:

Housekeeping values monitored via CCS and QLA within pre-defined limits derived from instrument level test results. Correct execution of commands.

Duration:

about 6 h

Applicable:

EPLM EQM

8.6 Short Functional Test Cold He 1

8.6.1 HIFI Short Functional Test Cold He 1

Title:

Short Functional Test Cold He 1

Experiment:

HIFI

Objectives:

Confidence test to check electrical integrity and operability of instrument. Evaluation will be based on housekeeping data, evaluation of science data is not foreseen.

Test Description:

Send the following commands: Power On (EPLM command), Stand-By, TBD, TBD,.... Monitor in parallel instrument power consumption (EPLM HK parameters) and instrument HK parameters. Measure power of mixer for minimum and maximum LO power settings.

Instrument Configuration:

As per Table 5-1 and Table 5-4.

Specific Requirements on EPLM:

None.

Particular Environmental Constraints:

CVV evacuated.

L0: TBD, L1: TBD and L2: TBD.

Success Criteria:

Housekeeping values within pre-defined limits. Correct execution of commands.

Duration:

1 h

Applicable:

EPLM EQM

8.6.2 PACS Short Functional Test Cold He 1

Title:

Short Functional Test Cold He 1

Experiment:

PACS

Objectives:

Confidence test to check electrical integrity and operability of instrument. Evaluation will be based on housekeeping data, evaluation of science data is not foreseen.

Test Description:

Send the following commands: Power On (EPLM command), Stand-By, TBD, TBD,.... Monitor in parallel instrument power consumption (EPLM HK parameters) and instrument HK parameters.

Instrument Configuration:

As per Table 5-2 and Table 5-4.

Specific Requirements on EPLM:

None.

Particular Environmental Constraints:

CVV evacuated.

L0: TBD, L1: TBD and L2: TBD.

Success Criteria:

Housekeeping values within pre-defined limits. Correct execution of commands.

Duration:

TBD h

Applicable:

EPLM EQM

8.6.3 SPIRE Short Functional Test Cold He 1

Title:**Short Functional Test Cold He 1****Experiment:****SPIRE****Objectives:**

Confidence test to check electrical integrity and operability of instrument. Evaluation will be based on housekeeping data, evaluation of science data is not foreseen.

Test Description:

The S/C-instrument interfaces are checked by switch on procedure (TBD).
The instrument is placed into a state ready to receive and execute commands (READY – TBC).
Each sub-system is commanded as appropriate to verify its function (TBD).
The instrument is switched back to READY.
The instrument may be switched OFF or to another mode if further tests are planned.

Instrument Configuration:

As per Table 5-3 and
Table 5-4.

Specific Requirements on EPLM:

None.

Particular Environmental Constraints:

CVV evacuated.
L0: TBD, L1: TBD and L2: TBD.

Success Criteria:

Housekeeping values monitored via CCS and QLA within pre-defined limits derived from instrument level test results. Correct execution of commands.

Duration:

about 6 h

Applicable:

EPLM EQM

8.7 Short Functional Test Cold He2

8.7.1 HIFI Short Functional Test Cold He2

Title:

Short Functional Test Cold He2

Experiment:

HIFI

Objectives:

Confidence test to check electrical integrity and operability of instrument. Evaluation will be based on housekeeping data, evaluation of science data is not foreseen.

Test Description:

Send the following commands: Power On (EPLM command), Stand-By, TBD, TBD,.... Monitor in parallel instrument power consumption (EPLM HK parameters) and instrument HK parameters. Measure power of mixer for minimum and maximum LO power settings.

Instrument Configuration:

As per Table 5-1 and
Table 5-4.

Specific Requirements on EPLM:

None.

Particular Environmental Constraints:

CVV evacuated.

L0: TBD, L1: TBD and L2: TBD.

Success Criteria:

Housekeeping values within pre-defined limits. Correct execution of commands.

Duration:

1 h

Applicable:

EPLM EQM

8.7.2 PACS Short Functional Test Cold He2

Title:

Short Functional Test Cold He2

Experiment:

PACS

Objectives:

Confidence test to check electrical integrity and operability of instrument. Evaluation will be based on housekeeping data, evaluation of science data is not foreseen.

Test Description:

Send the following commands: Power On (EPLM command), Stand-By, TBD, TBD,.... Monitor in parallel instrument power consumption (EPLM HK parameters) and instrument HK parameters.

Instrument Configuration:

As per Table 5-2 and Table 5-4.

Specific Requirements on EPLM:

None.

Particular Environmental Constraints:

CVV evacuated.

L0: TBD, L1: TBD and L2: TBD.

Success Criteria:

Housekeeping values within pre-defined limits. Correct execution of commands.

Duration:

TBD h

Applicable:

EPLM EQM

8.7.3 SPIRE Short Functional Test Cold He2

Title:

Short Functional Test Cold He2

Experiment:

SPIRE

Objectives:

Confidence test to check electrical integrity and operability of instrument. Evaluation will be based on housekeeping data, evaluation of science data is not foreseen.

Test Description:

The S/C-instrument interfaces are checked by switch on procedure (TBD).
The instrument is placed into a state ready to receive and execute commands (READY – TBC).
Each sub-system is commanded as appropriate to verify its function (TBD).
The instrument is switched back to READY.
The instrument may be switched OFF or to another mode if further tests are planned.

Instrument Configuration:

As per Table 5-3 and
Table 5-4.

Specific Requirements on EPLM:

None.

Particular Environmental Constraints:

CVV evacuated.
L0: TBD, L1: TBD and L2: TBD.

Success Criteria:

Housekeeping values monitored via CCS and QLA within pre-defined limits derived from instrument level test results. Correct execution of commands.

Duration:

about 6 h

Applicable:

EPLM EQM

8.8 Special Performance Tests

8.8.1 HIFI IF Properties

Title:
IF Properties

Experiment:
HIFI

Objectives:

Check IF standing waves due to representative coax cables between IF box and spectrometers as well as spectral features due to leakage / finite shielding / isolation.

Test Description:

In this test the IF chain of HIFI will be checked in a representative environment. Important changes with respect to HIFI DM tests are the change in harness (coax cables) and the environment (different locations / geometry / configuration and other systems involved). It is therefore needed to check the IF properties of the HIFI IF chain in terms of gain, noise, spectral ripple and spectral artefacts (spurs). The measurements will be performed with 3 bias settings per mixer.

Instrument Configuration:

As per Table 5-1 and Table 5-4.

Specific Requirements on EPLM:

None

Particular Environmental Constraints:

Mass flow rate: 2.2 mg/s.
L0: TBD, L1: TBD and L2: TBD.
Sensor background TBD.

Success Criteria:

IF gain / noise, ripple and spectrum within values applicable to IF chain.

Duration:

1 h

Applicable:

EPLM EQM

8.8.2 HIFI Radiometry

Title:
Radiometry

Experiment:
HIFI

Objectives:
Determination of (conversion) gain and noise temperature over the RF band.

Test Description:
The noise temperature and gain will be determined at a limited number of points within the mixer bands that are present. This test is needed to verify proper heterodyne functioning before entering the detailed performance assessment during EMC test. In addition an LO power scan will be performed at each frequency setting as input for the calibration table for the receiver tuning.

Instrument Configuration:
As per Table 5-1 and
Table 5-4.

Specific Requirements on EPLM:
None

Particular Environmental Constraints:
Mass flow rate: 2.2 mg/s.
L0: TBD, L1: TBD and L2: TBD.
Sensor background TBD.

Success Criteria:
Deviations determined by comparing to measurement results obtained during HIFI instrument level test are within TBD % or understood.

Duration:
1 day (TBC)

Applicable:
EPLM EQM

8.8.3 HIFI Reduced Standing Wave Test

Title:

Reduced Standing Wave Test

Experiment:

HIFI

Objectives:

Assessment of the level of reflections in the LO path (LOU to FPU).

Test Description:

During this test the level of reflections in the local optical paths (LOU to FPU) will be measured. Such reflections will cause artefacts in the instrument scientific data and it is important to verify that they are effectively suppressed. For reflections in the LO path, the LOU to FPU mixer coupling as a function of LO frequency will be measured.

Instrument Configuration:

As per Table 5-1 and Table 5-4.

Specific Requirements on EPLM:

Flight representative spacecraft configuration. For the LO path the test configuration will include representative baffles, shields and LO windows along the LO beam path.

Particular Environmental Constraints:

Mass flow rate: 2.2 mg/s.
L0: TBD, L1: TBD and L2: TBD.
Sensor background TBD.

Success Criteria:

Verification that the variation in LO path coupling due to standing waves is less than 20% peak-to-peak as a function of frequency. Comparison with measurement results obtained during HIFI DM ILT shall confirm LO path losses are within 20 % or understood.

Duration:

1 days

Applicable:

EPLM EQM

8.8.4 PACS Full Functional Test*Title:***Full Functional Test***Experiment:***PACS***Objectives:*

Validation of PACS switch-on procedure, including validation of connection between EGSE and instrument, memory load and dump. Validate function of DPU, function of SPU and data reduction/compression SW, validate function of DEC/MEC, validate function of BOLC/A, verify function of detectors, detector readouts, detector heaters and temperature sensors, verify function of mechanisms (grating, chopper and filter wheels), verify function of calibration sources, validate function of redundancy chains: not available at EQM Test, verify PACS autonomy functions (limit checks), verify PACS telemetry rates, verify time synchronisation procedure between CDMU and PACS, validate PACS deactivation (shut-down) procedure.

Test Description:

All available detector channels will be exercised by stimulation of internal sources and use of an external source (simulation of expected telescope background).

Instrument Configuration:

As per Table 5-2 and Table 5-4.

Specific Requirements on EPLM:

EPLM tilted about 20° to +y during cooler recycle.

Particular Environmental Constraints:

Mass flow rate: 2.2 mg/s.
L0: TBD, L1: TBD and L2: TBD.
Sensor background TBD.

Success Criteria:

Deviations determined by comparing to measurement results obtained during PACS DM ILT are within TBD % or understood.

Duration:

3 days (TBC)

Applicable:

EPLM EQM

8.8.5 PACS Short Performance Test

Title:**Short Performance Test****Experiment:****PACS****Objectives:**

Validation of PACS activation sequence, test PACS FPU thermal behaviour, performance test of PACS mechanisms, synchronous operation and grating offset accuracy, cooler recycling, detector electronics signal quality photoconductor part, detector electronics signal quality bolometer part, detector signal quality photoconductor part, detector signal quality bolometer part, performance of internal blackbody sources, check of spectrometer, cryostat background measurements (representative telescope flux simulation).

Test Description:

All available detector channels will be exercised by stimulation of internal sources and use of an external source (simulation of expected telescope background).

Instrument Configuration:

As per Table 5-2 and Table 5-4.

Specific Requirements on EPLM:

EPLM tilted about 20° to +y during cooler recycle.

Particular Environmental Constraints:

Mass flow rate: 2.2 mg/s.
L0: TBD, L1: TBD and L2: TBD.
Sensor background TBD.

Success Criteria:

Deviations determined by comparing to measurement results obtained during PACS DM ILT are within TBD % or understood.

Duration:

3 days (TBC)

Applicable:

EPLM EQM

8.8.6 PACS Astronomical Observation Template (AOT) Tests

Title:

Astronomical Observation Template (AOT) Tests

Experiment:

PACS

Objectives:

To verify in a short and representative way that the planned observation strategies (command sequences and data acquisition) are compatible with the system, pointing issues cannot be proven.

Test Description:

Test of PACS Single Band Photometry Mode,
 Test of PACS Dual Band Photometry Mode,
 Test of PACS Line Spectroscopy Mode,
 Test of PACS Range Spectroscopy Mode
 Test of PACS Calibration Measurement using FPU internal blackbodies.

Instrument Configuration:

As per Table 5-2 and
 Table 5-4.

Specific Requirements on EPLM:

EPLM tilted about 20° to +y during cooler recycle.

Particular Environmental Constraints:

Mass flow rate: 2.2 mg/s.
 L0: TBD, L1: TBD and L2: TBD.
 Sensor background TBD.

Success Criteria:

TBD.

Duration:

TBD day

Applicable:

PLM EQM

8.8.7 PACS PACS/SPIRE Parallel Mode*Title:***PACS/SPIRE Parallel Mode***Experiment:***PACS***Objectives:*

Verification of operability of PACS/SPIRE in parallel. Monitoring of PACS thermal behaviour with SPIRE being switched on.

Test Description:

PACS activation including cooler recycling,
PACS thermal behaviour, with SPIRE being switched on,
Test of PACS/SPIRE parallel mode AOT with PACS in single band Photometry mode,
Test of PACS/SPIRE parallel mode AOT with PACS in dual band Photometry mode,
PACS deactivation.

Instrument Configuration:

As per Table 5-2 and
Table 5-4.

Specific Requirements on EPLM:

EPLM tilted about 20° to +y during cooler recycle.

Particular Environmental Constraints:

Mass flow rate: 2.2 mg/s.
L0: TBD, L1: TBD and L2: TBD.
Sensor background TBD.

Success Criteria:

Deviations determined by comparing to measurement results obtained during PACS DM ILT are within TBD % or understood.

Duration:

1 day

Applicable:

EPLM EQM

8.8.8 SPIRE Cooler Recycle

Title:**Cooler Recycle****Experiment:****SPIRE****Objectives:**

To verify the temperature stability and balance of the SPIRE instrument during and after cooler recycle mode operations.

To prepare the instrument for operation with the photometer or spectrometer detectors.

Test Description:

The cryostat will be placed in a condition that as nearly as possible replicates the expected flight conditions i.e. the mass flow rate and shield temperatures must be those expected in flight. The SPIRE cooler recycle sequence will be carried out and the temperatures of the various stages monitored. The results will be compared to those from the SPIRE Instrument Thermal Model (ITMM)

Instrument Configuration:

As per Table 5-3 and Table 5-4.

Specific Requirements on EPLM:

EPLM tilted at least 17° around z-axis to +y. This operation can be carried out with the EPLM rotated to 90° in the same direction.

Particular Environmental Constraints:

Mass flow rate: 2.2 mg/s.

L0: TBD, L1: TBD and L2: TBD.

Sensor background TBD.

Success Criteria:

Cooler is successfully recycled and temperatures settle to within operational limits as predicted by the SPIRE ITMM.

Duration:

about 3 h

Applicable:

EPLM EQM

8.8.9 SPIRE Photometer Chop Mode

Title:**Photometer Chop Mode****Experiment:****SPIRE****Objectives:**

To verify the temperature stability and balance of the SPIRE instrument during photometer chopped mode operations.

Test Description:

The cryostat will be placed in a condition that as nearly as possible replicates the expected flight conditions i.e. the mass flow rate and shield temperatures must be those expected in flight.

The ambient background in the instrument is such as to allow meaningful signals from the detectors to be seen. This will be verified by a dedicated measurement.

The SPIRE cooler has been recycled and the instrument is at nominal temperature.

The photometer JFETs are switched on and the instrument temperatures allowed to settle.

A simulated photometer chop observation is carried out – this will include operation of the photometer calibrator and beam steering mirror.

The results will be compared to the ILT and the SPIRE ITMM.

Instrument Configuration:

As per Table 5-3 and Table 5-4.

Specific Requirements on EPLM:

None

Particular Environmental Constraints:

Mass flow rate: 2.2 mg/s.

L0: TBD, L1: TBD and L2: TBD.

Photon background on the detector in the 420-580 μm band within x5 (TBC) of that expected in flight – this equivalent to a blackbody of $< \sim 20$ K in the beam of SPIRE.

This may be achieved using the SPIRE shutter (TBD).

Success Criteria:

The instrument temperatures stay within pre-defined limits as predicted by the SPIRE ITMM.

No excess background is seen on the detectors during operations.

Duration:

about 1 h

Applicable:

EPLM EQM

8.8.10 SPIRE Ambient Background Verification*Title:*

Ambient Background Verification

Experiment:

SPIRE

Objectives:

To check the photon background on the photometer detectors after cooler recycle and before all other tests.

Test Description:

The EQM cryostat will be placed in a condition that as nearly as possible replicates the expected flight conditions, i.e. the mass flow rate and shield temperatures must be those expected in flight. The SPIRE cooler has been recycled and the instrument is at nominal temperature. The photometer JFETs are switched on and the instrument temperatures allowed to settle. The SPIRE shutter may be closed (TBD). Load curves are taken on the photometer detectors by varying the bias voltage.

Instrument Configuration:

As per Table 5-3 and Table 5-4.

Specific Requirements on EPLM:

None

Particular Environmental Constraints:

Mass flow rate: 2.2 mg/s.
L0: TBD, L1: TBD and L2: TBD.
Sensor background TBD.

Success Criteria:

Data analysed in real time to calculate the background flux on the detectors. Background should be within limits defined for the follow on test.

Duration:

about 1 h

Applicable:

EPLM EQM

8.8.11 SPIRE Spectrometer Mode*Title:***Spectrometer Mode***Experiment:***SPIRE***Objectives:*

To verify the temperature stability and balance of the SPIRE instrument during spectrometer mode operations.

Test Description:

The cryostat will be placed in a condition that as nearly as possible replicates the expected flight conditions i.e. the mass flow rate and shield temperatures must be those expected in flight.

The ambient background in the instrument is such as to allow meaningful signals from the detectors to be seen. This will be verified by a dedicated test.

The SPIRE cooler has been recycled and the instrument is at nominal temperature.

The spectrometer JFETs are switched on and the instrument temperatures allowed to settle.

The spectrometer calibrator is switched on.

A simulated spectrometer chop observation is carried out – this will include operation of the photometer calibrator and beam steering mirror.

The results will be compared to the ILT and the SPIRE ITMM.

Instrument Configuration:

As per Table 5-3 and Table 5-4.

Specific Requirements on EPLM:

EPLM tilted at least 85° around z-axis to either +y or -y direction.

Particular Environmental Constraints:

Mass flow rate: 2.2 mg/s.

L0: TBD, L1: TBD and L2: TBD.

Photon background on the detector in the 420-580 μm band within x5 (TBC) of that expected in flight – this equivalent to a blackbody of <~ 20 K in the beam of SPIRE.

This may be achieved using the SPIRE shutter (TBD).

Success Criteria:

The instrument temperatures stay within pre-defined limits as predicted by the SPIRE ITMM.

No excess background is seen on the detectors during operations.

Duration:

about 1 h

Applicable:

EPLM EQM

8.8.12 SPIRE PACS/SPIRE Parallel Mode

Title:

Experiment:

SPIRE

Objectives:

TBD

Test Description:

TBD.

Instrument Configuration:

As per Table 5-3 and
Table 5-4.

Specific Requirements on EPLM:

EPLM tilted about 20° to +y during PACS cooler recycling. EPLM tilted at least 17° around z-axis to +y during SPIRE cooler recycle.

Particular Environmental Constraints:

Mass flow rate: 2.2 mg/s.
L0: TBD, L1: TBD and L2: TBD.
Sensor background TBD.

Success Criteria:

TBD

Duration:

TBD day

Applicable:

EPLM EQM

8.9 Integrated Module Tests

8.9.1 HIFI Integrated Module Test

Title:

Integrated Module Test

Experiment:

HIFI

Objectives:

Verification of the functional performance of the integrated instrument in all modes. Check of the instrument performance as far as possible with EPLM configuration.

Test Description:

The Integrated Module Test is composed by the following test steps: 1) Short Functional Test, 2) IF Properties, 3) Radiometry (for TBD receiver settings), 4) Reduced Standing Wave Test, 5) Stability Test (TBC). For details to the single test steps see the related Test Activity Descriptions. The Stability Test is TBD.

Instrument Configuration:

As per Table 5-1 and Table 5-4.

Specific Requirements on EPLM:

None.

Particular Environmental Constraints:

Mass flow rate: 2.2 mg/s.
L0: TBD, L1: TBD and L2: TBD.
Sensor background TBD.

Success Criteria:

Housekeeping values within pre-defined limits. Correct execution of commands. No performance degradation with respect to instrument level test results.

Duration:

3 days (TBC)

Applicable:

EPLM EQM

8.9.2 PACS Integrated Module Test

Title:

Integrated Module Test

Experiment:

PACS

Objectives:

Verification of the functional performance of the integrated instrument in all modes. Check of the instrument performance as far as possible with EPLM configuration.

Test Description:

The Integrated Module Test is composed by the following test steps: TBD. For details to the single test steps see the related Test Activity Descriptions.

Instrument Configuration:

As per Table 5-2 and Table 5-4.

Specific Requirements on EPLM:

EPLM tilted about 20° to +y during cooler recycle.

Particular Environmental Constraints:

Mass flow rate: 2.2 mg/s.
L0: TBD, L1: TBD and L2: TBD.
Sensor background TBD.

Success Criteria:

Housekeeping values within pre-defined limits. Correct execution of commands. No performance degradation with respect to instrument level test results.

Duration:

TBD

Applicable:

EPLM EQM

8.9.3 SPIRE Integrated Module Test*Title:***Integrated Module Test***Experiment:***SPIRE***Objectives:*

Verification of the functional performance of the integrated instrument in all modes. Check of the instrument performance as far as possible with EPLM configuration.

Test Description:

The Integrated Module Test is composed by the following test steps: (TBD). For details to the single test steps see the related Test Activity Descriptions.

Instrument Configuration:

As per Table 5-3 and Table 5-4.

Specific Requirements on EPLM:

EPLM tilted at least 17° around z-axis to +y during cooler recycle.

Particular Environmental Constraints:

Mass flow rate: 2.2 mg/s.

L0: TBD, L1: TBD and L2: TBD.

Photon background on the detector in the 420-580 μm band within x5 (TBC) of that expected in flight – this equivalent to a blackbody of <~ 20 K in the beam of SPIRE.

This may be achieved using the SPIRE shutter (TBD).

Success Criteria:

Housekeeping values within pre-defined limits. Correct execution of commands. No performance degradation with respect to instrument level test results.

Duration:

TBD

Applicable:

EPLM EQM

8.10 EMC Tests

8.10.1 HIFI EMC Test

Title:

EMC Test

Experiment:

HIFI

Objectives:

Check of instrument functional performance in its most sensitive mode under electromagnetic worst case conditions (conducted and radiated EMC).

Test Description:

During this test the EMC susceptibility of HIFI in a representative environment will be assessed. Susceptibility will be measured in terms of changes in performance parameters like noise temperature, but also in terms of spectral information (spurious responses). The RF bands will be fully tested on performance for a TBD number of receiver settings. The internal calibration source will be used as the stimuli for the performance test and to search for EMI of the IF chain. For verification of the absence of EMI of the LO an external line test source, comprising a harmonic generator driven by a microwave synthesiser, will be required. This test signal will be injected with a beamsplitter between the LOU and the CVV window. IF properties might be separately tested under simulated EMC environment again as part of this EMC test.

Instrument Configuration:

As per Table 5-1 and Table 5-4 including a harmonic generator with beam splitter mounted between the LOU and CVV window.

Specific Requirements on EPLM:

Representative spacecraft configuration, representative configuration of LO windows and beam path, representative cryoharness, representative ground impedance between SVM and EPLM.

Particular Environmental Constraints:

Mass flow rate: 2.2 mg/s.
L0: TBD, L1: TBD and L2: TBD.
Sensor background TBD.

Success Criteria:

Deviations from measurement results obtained during HIFI DM ILT are within TBD % or understood.

Duration:

2 days

Applicable:

EPLM EQM

8.10.2 PACS EMC Test

Title:
EMC Test

Experiment:
PACS

Objectives:

Check of instrument functional performance in its most sensitive mode under electromagnetic worst case conditions (conducted and radiated EMC).

Test Description:

During ILT, two specific EMC test sequences will be developed. During EQM, performance of these sequences will allow verification of certain EMC requirements in addition to the results from specified test set-ups. Note: EQM EMC testing might very likely require conducted and radiated emission and conducted and radiated susceptibility measurements (details still TBD).

PACS activation including cooler recycling,

PACS in "most noisy" mode(s) (all actuators ON, etc.),

PACS in "most sensitive" mode(s) (all mechanisms quiet except chopper, all detector read-outs in most sensitive status, etc.),

PACS deactivation.

Instrument Configuration:

As per Table 5-2 and
Table 5-4.

Specific Requirements on EPLM:

EPLM tilted about 20° to +y during cooler recycle.

Particular Environmental Constraints:

Mass flow rate: 2.2 mg/s.

L0: TBD, L1: TBD and L2: TBD.

Sensor background TBD.

Success Criteria:

Deviations from measurement results obtained during HIFI DM ILT are within TBD % or understood.

Duration:
2 days

Applicable:
EPLM EQM

8.10.3 SPIRE EMC Test

Title:
EMC Test

Experiment:
SPIRE

Objectives:

Check of instrument functional performance in its most sensitive mode (Photometer Standby) under electromagnetic worst case conditions (conducted and radiated EMC).

Test Description:

The EQM cryostat will be placed in a condition that as nearly as possible replicates the expected flight conditions i.e. the mass flow rate and shield temperatures must be those expected in flight. The ambient photon background in the instrument is low enough such that meaningful noise measurements can be made on the detectors. The background will be verified by a dedicated test. The SPIRE cooler has been recycled and the instrument is at nominal temperature. The photometer JFETs are switched on and the instrument temperatures allowed to settle. Noise traces are taken from the detectors at the highest data sampling frequency allowed by the electronics before and during conducted and radiated EM testing. The results will be compared to the ILT and the SPIRE EMC model.

Instrument Configuration:

As per Table 5-3 and Table 5-4.

*Specific Requirements on EPLM:**Particular Environmental Constraints:*

Mass flow rate: 2.2 mg/s.

L0: TBD, L1: TBD and L2: TBD.

Photon background on the detector in the 420-580 μm band within x5 (TBC) of that expected in flight – this equivalent to a blackbody of $<\sim 20$ K in the beam of SPIRE.

This may be achieved using the SPIRE shutter (TBD).

Success Criteria:

No excess noise on the detectors. Deviations from measurement results obtained during HIFI DM ILT are within TBD % or understood.

Duration:
TBD

Applicable:
EPLM EQM

	Name	Dep./Comp.		Name	Dep./Comp.
	Alberti von Mathias Dr.	SM 34		Schmidt Rudolf	ACE 32
	Alo Hakan	OTN/LP 45		Schweickert Gunn	SM 34
	Barlage Bernhard	ED 11		Stauss Oliver	SM 33
x	Bayer Thomas	ED 541		Steininger Eric	ED 422
x	Faas Horst	EA 65	x	Stritter Rene	ED 11
	Fehringer Alexander	SM 33		Suttner Klaus	SM 32
	Frey Albrecht	ED 422		Tenhaeff Dieter	SM 34
	Gerner Willi	ED 11		Thörmer Klaus-Horst Dr.	OTN/ED 65
	Grasl Andreas	OTN/EN 64		Wagner Adalbert	OTN/LP 45
	Grasshoff Brigitte	ED 521		Wagner Klaus	SM 31
	Hartmann Hans Dr.	ED 422		Wietbrock, Walter	ED 521
x	Hauser Armin	SM 31		Wöhler Hans	SM 34
	Hinger Jürgen	SM 31		Zipf Ludwig	ACE 32
x	Hohn Rüdiger	ED 541			
x	Hölzle Edgar	ED 421			
	Huber Johann	ED 543		Alcatel	ASP
	Hund Walter	SE 76	x	ESA/ESTEC	ESA
x	Idler Siegmund	ED 432			
x	Ivány von András	ACE 32		Instruments:	
	Jahn Gerd Dr.	SM 31	x	MPE (PACS)	MPE
x	Kalde Clemens	ED 532	x	RAL (SPIRE)	RAL
	Kameter Rudolf	OTN/EN 64	x	SRON (HIFI)	SRON
x	Kersting Stefan	OTN/EN 63		Subcontractors:	
	Kettner Bernhard	SM 34		Air Liquide, Space Department	AIR
	Knoblauch August	ED 531		Air Liquide, Space Department	AIRS
x	Koelle Markus	ED 523		Air Liquide, Orbital System	AIRT
	Kroeker Jürgen	ED 542		Alcatel Bell Space	ABSP
	Kunz Oliver	SM 31		Astrium Sub-Subsyst. & Equipment	ASSE
	Lamprecht Ernst	OTN/SM 222		Austrian Aerospace	AAE
	Lang Jürgen	SE 76		Austrian Aerospace	AAEM
	Langfermann Michael	ED 541		APCO Technologies S. A.	APCO
x	Mack Paul	OTN/EN 64		Astrium GmbH Space Infrastr.	ASIP
	Moritz Konrad Dr.	ED 65		Bieri Engineering B. V.	BIER
	Muhl Eckhard	OTN/EN 64		BOC Edwards	BOCE
x	Pastorino Michel	ASPI Resid.		Dutch Space Solar Arrays	DSSA
	Peitzker Helmut	ED 65		EADS CASA Espacio	CASA
	Peltz Heinz-Willi	SM 33		EADS CASA Espacio	ECAS
	Peters, Gerhard	ED 531		Eurocopter	ECD
	Pietroboni Karin	ED 65		HTS AG Zürich	HTSZ
	Puttlitz Joachim	OTN/EN 64		Linde	LIND
	Rebholz Reinhold	ED 541		Patria New Technologies Oy	PANT
	Reuß Friedhelm	ED 62		Phoenix, Volkmarsen	PHOE
x	Rühe Wolfgang	ED 6		Prototech AS	PROT
x	Runge Axel	OTN/EN 64		Rembe, Brilon	REMB
	Sachsse Bernt	ED 21		SENER Ingenieria SA	SEN
	Schäffler Johannes	OTN/EN 64		Stöhr, Königsbrunn	STOE
x	Schink Dietmar	ED 422		Rosemount Aerospace GmbH	ROSE
x	Schlosser Christian	OTN/EN 64		RYMSA, Radiación y Microondas S.A.	RYM