

SPIRE-ALC-DOC-001183



**Environment and Tests Requirements (EvTR)**

**H-P-1-ASPI-SP-0030**

**Product Code : 000 000**

<b>Rédigé par/ Written by</b>	<b>Responsabilité-Service-Société Responsibility-Office -Company</b>	<b>Date</b>	<b>Signature</b>
B.Chidaine	System Engineer	25/10/04	
<b>Vérfié par/ Verified by</b>			
P.Rideau	System Engineering Manager	21/11/04	
D.Montet	AIV Manager	3.11.04	
<b>Approbation/ Approved</b>			
Ch.Masse	P.A. Manager	05.11.04	
J.-J. Juillet	Project Manager	04.11.04	

Data management : Christiane GIACOMETTI

Entité Emettrice : Alcatel Space - Cannes  
(détentrice de l'original) :

# ENVIRONMENT AND TESTS REQUIREMENTS (EVTR)

REFERENCE : H-P-1-ASPI-SP-0030

DATE : 07-Oct-2004

ISSUE : 5.0

PAGE : 2/89

## DISTRIBUTION / *DISTRIBUTION RECORD*

EXTERNAL DISTRIBUTION	For Information For Application For Approbation For Action For Acceptation	INTERNAL DISTRIBUTION	
<b>ESA</b>	For Information	<b>HP team</b>	X
<b>ASTRIUM</b>	For Application	P.Rideau	X
<b>ALENIA</b>	For Application	Y.Roche	X
	For Application	B.Chidaine	X
	For Application	K.Hibberd	X
	For Application	A.Luc	X
	For Application	P.Couzin	X
	For Application	B.Collaudin	X
	For Application	Ph.Clavel	X
	For Application	B.Marchand	X
	For Application	B.Demolder	X
	For Application	L.Houchet	X
	For Application upon decision of B.Marchand	S.Wolf	X
	For Application upon decision of P.Armand	D.Montet	X
	For Application upon decision of P.Armand	Y.Pocchiola	X
	For Application upon decision of Y.Pocchiola	P.Armand	X
	For Application upon decision of Y.Pocchiola	J.B.Riti	X
	For Application upon decision of Y.Pocchiola	Ch.Bainier	X
	For Application upon decision of Y.Pocchiola	M.Pastorino	X
	For Application upon decision of Y.Pocchiola	O.Fratacci	X
	For Application upon decision of Ph.Schlosser	J.M.Reix	X
	For Application upon decision of Ph.Schlosser	Ph.Schlosser	X
	For Application upon decision of Ph.Schlosser	<b>Clf Documentation</b>	Orig.

# ENVIRONMENT AND TESTS REQUIREMENTS (EVTR)

REFERENCE : H-P-1-ASPI-SP-0030

DATE : 07-Oct-2004

ISSUE : 5.0

PAGE : 3/89

## ENREGISTREMENT DES EVOLUTIONS / *CHANGE RECORD*

Herschel / Planck			CHANGE RECORD	
ISSUE	REV.	DATE	MODIFICATIONS	APPROVAL
01	01	03/05/00 13/09/00	Initial issue Update Planck axes in accordance with SRS definition (page 6 and 18) Update of ARIANE 5 requirements taking into account Issue 3 of User's Manual (page 8, 9,10)	
02	01	31/10/00 15/06/01	All pages updated Updated taking into account ESA and ALENIA comments	
03		27/07/01	Commentary added in ENVM-030 Updated paragraph 3.4.4.2. Updated random levels. Updated taking into account the changes in issue 2 of the SRS. (see change bars)	

# ENVIRONMENT AND TESTS REQUIREMENTS (EVTR)

REFERENCE : H-P-1-ASPI-SP-0030

DATE : 07-Oct-2004

ISSUE : 5.0

PAGE : 4/89

ISSUE	REV.	DATE	MODIFICATIONS	APPROVAL
	01	12/11/01	<p>§ 1: reference to Modules Interface Specifications for definition of detailed module environment</p> <p>§ 2.1: addition of H-PLM, P-PLM and SVM Interface Specifications as applicable documents</p> <p>§ 2.2,1 Issue of A5UM added</p> <p>§2.2.2 "Other reference documents" added with Design &amp; Development Plan as new reference document</p> <p>§ 3.3.2.2: frequency range for low frequency sinusoidal vibrations updated to 5-25.</p> <p>§ 3.3.3.2: correction of typo</p> <p>§ 3.3.3.3 unit for wavelength in solar spectrum definition changed to microns (RID PLM-015)</p> <p>Table 4.1-1: Test tolerances for Acoustic Vibration updated in accordance with RID AIV-34</p> <p>New section 4.2 (RID AIV-032)</p> <p>§ 4.3.2.5.1: addition of empty fixture vibration test</p> <p>§ 4.3.2.5.2: modified paragraph on notching, definition of sweep rate which was missing. Updated values for Fuel tanks sinusoidal vibration levels.</p> <p>§ 4.3.2.5.3: new paragraph on notching</p> <p>Table 4.3-1: Updated sinus vibration levels for electronic boxes in accordance with Minutes of Meeting H-P-ASPI-MN-544, dated 07/11/01</p> <p>Table 4.3-1: updated values for RCS elements qualification temperatures in line with RCS specification.</p>	
3	2	19-Feb-2002	<ul style="list-style-type: none"> <li>• RD-7: added in answer to AI#3 of MoM H-P-1-ASPI-909.</li> <li>• RD-8 : added as an ESA input from SAWG.</li> <li>• ENVM-060 : updated according to the "MGSE General Specification" H-P-1-ASPI-SP-0044.</li> <li>• §3.3.3.2 Launch phase / saa : updated according to fax H-P-ASPI-LT-819.</li> <li>• §3.3.3.3 : Solar spectrum section updated with RD-8.</li> <li>• Table 3.4-1 : updated.</li> <li>• Table 3.4-2 : updated.</li> <li>• §3.4.3 Thermal environment / saa / HERSCHEL : updated according to fax H-P-ASPI-LT-819.</li> <li>• §3.4.4.3 : updated in answer to AI#3 of MoM H-P-1-ASPI-909. ENVM-080 deleted.</li> <li>• §4.3.2.5.2 : typing error corrected.</li> <li>• §4.3.2.5.3 : First sentence added according to MoM H-P-1-ASPI-909.</li> <li>• Table 4.3-2 : "diplexer" replaced by "RFDN" according to MoM H-P-1-ASPI-909.</li> <li>• Table 4.3-3 : "diplexer" replaced by "RFDN" according to MoM H-P-1-ASPI-909.</li> <li>• Table 4.3-6 : "diplexer" replaced by "RFDN" and minimum temperature of "Thrusters (valves)" updated according to MoM H-P-1-ASPI-909.</li> </ul>	I.Bénilan

# ENVIRONMENT AND TESTS REQUIREMENTS (EVTR)

REFERENCE : H-P-1-ASPI-SP-0030

DATE : 07-Oct-2004

ISSUE : 5.0

PAGE : 5/89

Issue. Revision	DATE	§ : DESCRIPTION DES EVOLUTIONS § : CHANGE RECORD	REDACTEUR AUTHOR
4.0	25-Jun-2002	<p><b>GENERAL</b> Issue for the PDR Data Package Requirements are identified and numbered. "Cryo elec" replaced by "CCU". "equipment" replaced by "unit" (except for "test equipment").</p> <p><b>Ch.1</b> : Scope updated.</p> <p><b>Ch.2</b> AD-3 : reference corrected. AD-4 to AD-9 : deleted (not mentioned in this document). AD-10 : created and RD-7 deleted according to SRS update for PDR (fax SCI-PT/12693 dated 02-May-2002). Change Requests H-P-ASPI-CR-0120 (ASED), H-P-ASPI-CR-0121 (ALS), H-P-ASPI-CR-0122 (CSAG) have been sent. RD-2 to RD-5 : deleted (not mentioned in this document). RD-7 : deleted (replaced by AD-10). RD-9 to -17 : added. §2.3 Acronyms : created.</p> <p><b>Ch.3</b> §3.2.3, Table 3.2-1 : limit load factors "on dollies and trolleys" have been updated with the values given in the "MGSE Specification" (ref. H-P-1-ASPI-SP-044). §3.2.4.1, ENVM-040 : humidity during transport and storage put in line with humidity during ground operations. §3.2.4.1, ENVM-050 : updated according to ENVM-040. §3.3.2.4 (acoustic) : modulation by filling ratio updated §3.3.2.5 Shock : Figure 3-5 updated with shock_spec_05_12_2001.pdf. Creation of Table 3.3-5. §3.3.3.2 (aerothermal fluxes) : updated. §3.3.3.2 (saa) : reworded according to fax H-P-ASPI-LT-1516 dated 27-May-2002. §3.3.3.2 (Eclipse) : updated according to SRS update for PDR (fax SCI-PT/12693 dated 02-May-2002). §3.3.4.1 Pressure : Figure 3-10 updated. Table 3.4-2 (Planck constant accelerations) updated according to fax HP-ASPI-LT-1387 dated 24-Apr-2002. §3.4.3 (saa) reworded according to fax H-P-ASPI-LT-1516 dated 27-May-2002. §3.4.3, Figure 3-14 Planck attitude constraints : 10° must be understood as the half cone angle. §3.4.3 Angle between spin axis and Earth renamed : also named "Earth aspect angle" and max value updated as a consequence of the Planck orbit size increase from 10° to 15°. §3.4.3 (Eclipse) : updated according to SRS update for PDR (fax SCI-PT/12693 dated 02-May-2002). § 3.4.4.2.1: Duration requirement to survive the space radiation environment deleted. Covered by following data in section 3.4.4.2.1 and by GDIR requirements ENVR-005 and ENVR-030.</p>	I.Bénilan

# ENVIRONMENT AND TESTS REQUIREMENTS (EVTR)

REFERENCE : H-P-1-ASPI-SP-0030

DATE : 07-Oct-2004

ISSUE : 5.0

PAGE : 6/89

Issue. Revision	DATE	§ : DESCRIPTION DES EVOLUTIONS § : CHANGE RECORD	REDACTEUR AUTHOR
		<p>§3.4.4.3 (Micrometeorites) : updated according to SRS update for PDR (fax SCI-PT/12693 dated 02-May-2002). Change Requests H-P-ASPI-CR-0120 (ASED), H-P-ASPI-CR-0121 (ALS), H-P-ASPI-CR-0122 (CSAG) have already been sent.</p> <p><b>Ch.4</b></p> <p>§4.2.1 Environmental test summary :Table 4.2-1 updated.</p> <p>§4.2.2.2 sine : Table 4.2-2 completed with A5UM data (RD-1).</p> <p>§4.2.3.5.1 (resonance search test) : test parameters are TBC .</p> <p>§4.2.2.4, ENV-180 : shock test baseline precised.</p> <p>§4.3.2.5.3, Table 4.3-2, -3 : random levels updated</p> <p>§4.3.2.5.3 : "General case by default" updated according to MoM H-P-ASPI-MN-1439 dated 13-May-2002.</p> <p>§4.3.2.5.4, Table 4.3-5 : shock levels updated</p> <p>§4.3.2.5.4 : Table 4.3-6 unit qualification test temperature updated with TSU-MAX, SREM, VMC.</p> <p>§4.3.2.5.4, Figure 4-1 "temperature cycling" : typing error corrected (second TO-MAX replaced by TO-MIN).</p> <p>§4.4 : MRB replaced by NRB to be in line with AD-3.</p>	
4.1	15-May-2003	<p>Update generated with DOORS 5.2 / TREK 3.</p> <p>AD-10 : name and reference modified, but content unchanged ("Solid Particle Environment for NGST" replaced by the one defined for H/P in SENV-215 H/P of SRS 3.0).</p> <p>§3.3.1 : updated (switch to A5 ECA)</p> <p>§3.3.3.2 : updated (SYLDA 5 replaced by SPELTRA)</p> <p>Figure 3-7 : updated (preliminary aerothermal flux on A5 ECA)</p> <p>SAA : updated according to H-P-2-ASPI-SP-0250_2_0 (which supersedes EvTR for the H-EPLM Contractor).</p> <p>§3.4.4.3 : "micrometeorite" is replaced by "solid particle" (SENV-215 H/P of SRS 3.0).</p> <p>§4.2 : renamed.</p> <p>§4.2.2.4 : first bullet in the notes deleted.</p> <p>Appendix 1 : created.</p> <p><u>Requirements modified in, deleted in or new in issue 4.1 :</u> see the changes history below.</p>	I.Bénilan

## Change History (list of requirements modified, deleted or new in issue 4.1)

§ nb	Req. identifier	Change Status	Doc. issue	Reason of Change	Change Ref.
§3.2.3	[ENVM-030 a]	Modified in	4.1	ASP clarification in answer to ASED comments on EvTR 4.0 (Fax H-P-ASPI-LT-1973 dated 08-Oct-2002)	H-P-ASP-CR-0474 (ALS)

# ENVIRONMENT AND TESTS REQUIREMENTS (EVTR)

REFERENCE : H-P-1-ASPI-SP-0030

DATE : 07-Oct-2004

ISSUE : 5.0

PAGE : 7/89

§ nb	Req. identifier	Change Status	Doc. issue	Reason of Change	Change Ref.
§3.2.4.2	[ENVM-060 a]	Modified in	4.1	ASP clarification in answer to ASED comments on EvTR 4.0 (Fax H-P-ASPI-LT-1973 dated 08-Oct-2002)	H-P-ASP-CR-0474 (ALS)
§3.3.3.1	[ENVM-140 a]	Modified in	4.1	SYLDA-5 replaced by SPELTRA.	H-P-ASP-CR-0474 (ALS)
§3.3.3.2	[ENVM-165 a]	Modified in	4.1	SYLDA-5 replaced by SPELTRA.	H-P-ASP-CR-0474 (ALS)
§3.3.3.2	[ENVM-170 a]	Modified in	4.1	Update of HERS-0050 in the release of H-P-2-ASPI-SP-0250_2_0 (which supersedes EvTR for the H-EPLM Contractor).	H-P-ASP-CR-0474 (ALS)
§4.1.3	[ENVT-030 a]	Modified in	4.1	Table 4.1-1 renamed and moved from ENVT-050 to ENVT-030.	
§4.1.5	[ENVT-050 a]	Modified in	4.1	Table 4.1-1 renamed and moved from ENVT-050 to ENVT-030.	H-P-ASP-CR-0474 (ALS)
§4.2.1	[ENVT-110 a]	Modified in	4.1	ASP clarification in answer to ASED comments on EvTR 4.0 (Fax H-P-ASPI-LT-1973 dated 08-Oct-2002)	
§4.2.1	[ENVT-113 ]	New in	4.1	ASP clarification in answer to ASED comments on EvTR 4.0 (Fax H-P-ASPI-LT-1973 dated 08-Oct-2002)	H-P-ASP-CR-0474 (ALS)
§4.2.1	[ENVT-116 ]	New in	4.1	ASP clarification in answer to ASED comments on EvTR 4.0 (Fax H-P-ASPI-LT-1973 dated 08-Oct-2002)	
§4.3.2.5.4	[ENVT-370 a]	Modified in	4.1	ASP clarification in answer to ASED comments on EvTR 4.0 (Fax H-P-ASPI-LT-1973 dated 08-Oct-2002)	H-P-ASP-CR-0474 (ALS)
§4.3.2.5.4	[ENVT-373 ]	New in	4.1	ASP clarification in answer to ASED comments on EvTR 4.0 (Fax H-P-ASPI-LT-1973 dated 08-Oct-2002)	
§4.3.2.5.4	[ENVT-376 ]	New in	4.1	ASP clarification in answer to ASED comments on EvTR 4.0 (Fax H-P-ASPI-LT-1973 dated 08-Oct-2002)	

Issue. Revision	DATE	§ : CHANGE RECORD	AUTHOR
4.2 Draft	Sep-2003	Draft update generated with DOORS 5.2 / TREK 3 for review with SVM Contractor. <b>Change bars</b> are indicated in the margin for modifications introduced since <b>issue 4.0</b> .	I.Bénilan
4.2	25-Nov-2003	Update generated with DOORS 5.2 / TREK 3 following: - SVM AD Convergence Meeting - System EvTR - Mechanical splinter, ref. H-P-ASP-MN-3607 dated 09 & 10-Sep-2003. - SVM AD Convergence Meeting - System EvTR - Thermal splinter, ref. H-P-ASP-MN-3608 dated 11-Sep-2003.  In this issue, the <b>change bars</b> show the paragraphs new or	I.Bénilan

# ENVIRONMENT AND TESTS REQUIREMENTS (EVTR)

REFERENCE : H-P-1-ASPI-SP-0030

DATE : 07-Oct-2004

ISSUE : 5.0

PAGE : 8/89

Issue. Revision	DATE	§ : CHANGE RECORD	AUTHOR
		<p>modified <b>since issue 4.1</b>. Requirements deleted in issue 4.1 or before are not displayed.</p> <p>§1: Note deleted.</p> <p>RD-17: updated according to H-P-ASP-MN-3607. RD-18: new as agreed in H-P-ASP-MN-3608. RD-19: new (in complement of RD-18).</p> <p>§2.3 Acronyms: updated</p> <p>§3.3.1 Mission phase definition: SPELTRA replaced by SYLDA 5.</p> <p>§3.3.3.2 Launch phase, Aerothermal flux: SPELTRA replaced by SYLDA 5.</p> <p>§3.3.3.3 Solar constant variation with distance: updated with reference to RD-18.</p> <p>§3.4.1: introduction of the acronyms IOP, COP, PVP, ROP, DIP. "Routine observation phase" is replaced by "Routine Operations Phase". "Telecommunication Phase" and "Observation Phase" replaced by "Telecommunication Period" and "Observation Period".</p> <p>§3.4.3: note about possible Moon transit added after ENVM-330.</p> <p><u>Requirements modified, deleted or new in issue 4.2</u> : see list below.</p>	

## List of requirements modified, deleted or new in issue 4.2

§ nb	Req. identifier	Change Status	Doc. issue	Reason of Change	Change Ref.
§3.2.4.1	<b>[ENVM-040 a]</b>	Modified in	4.2	H-P-ASP-MN-3607: Temperature range during transportation reduced from [-10, 50] to [+10, +30].	H-P-ASP-CR-0474 (ALS)
§3.3.3.1	<b>[ENVM-140 b]</b>	Modified in	4.2	SPELTRA replaced by SYLDA 5.	H-P-ASP-CR-0474 (ALS)
§3.3.3.2	<b>[ENVM-165 b]</b>	Modified in	4.2	SPELTRA replaced by SYLDA 5.	H-P-ASP-CR-0474 (ALS)
§3.3.3.2	<b>[ENVM-175 ]</b>	New in	4.2	Confirmation by Arianespace of the launcher roll excursions at FJ and EPC/ECA separation (closure of AI#3 of Herschel Telescope Thermal IF meeting, ESTEC 27-May-2003).	H-P-ASP-CR-0474 (ALS)
§3.3.3.2	<b>[ENVM-175 a]</b>	Modified in	4.2	Update of saa in pitch.	H-P-ASP-CR-0474 (ALS)
§3.3.3.2	<b>[ENVM-190 a]</b>	Modified in	4.2	H-P-ASP-MN-3608.	H-P-ASP-CR-0474 (ALS)



# ENVIRONMENT AND TESTS REQUIREMENTS (EVTR)

REFERENCE : H-P-1-ASPI-SP-0030

DATE : 07-Oct-2004

ISSUE : 5.0

PAGE : 9/89

§ nb	Req. identifier	Change Status	Doc. issue	Reason of Change	Change Ref.
§3.4.3	<b>[ENVM-280 a]</b>	Modified in	4.2	H-P-ASP-MN-3608.	H-P-ASP-CR-0474 (ALS)
§4.1.3	<b>[ENVT-030 b]</b>	Modified in	4.2	Teleconference with ASED held 27-Jun-2003. Random test tolerance: Fax H-P-ASPI-LT-1985 dated 16-Oct-2002 and the answer of ASED in fax HP-ASED-FX-0802-02 dated ..-Nov-2002.	H-P-ASP-CR-0459 (ASED) H-P-ASP-CR-0474 (ALS)
§4.2.1	<b>[ENVT-110 b]</b>	Modified in	4.2	Teleconference with ASED held 27-Jun-2003.	H-P-ASP-CR-0459 (ASED) H-P-ASP-CR-0474 (ALS)
§4.2.1	<b>[ENVT-113 a]</b>	Modified in	4.2	H-P-ASP-MN-3607.	H-P-ASP-CR-0474 (ALS)
§4.2.1	<b>[ENVT-116 a]</b>	Modified in	4.2	Teleconference with ASED held 27-Jun-2003: - Low sine test for HEPLM PFM has been cancelled (see HEPLM Schedule Meeting H-P-ASPI-MN-2560 dated 17-Jan-2003). - IMT performed for HEPLM EQM (not IST).	H-P-ASP-CR-0459 (ASED)
§4.3.2.5.2	<b>[ENVT-340 a]</b>	Modified in	4.2	H-P-ASP-MN-3607.	H-P-ASP-CR-0474 (ALS)
§4.3.2.5.3	<b>[ENVT-350 a]</b>	Modified in	4.2 draft		
§4.3.2.5.3	<b>[ENVT-350 b]</b>	Modified in	4.2	Closure of AI#1 of H-P-ASP-MN-3607.	H-P-ASP-CR-0474 (ALS)
§4.3.2.5.3	<b>[ENVT-360 a]</b>	Deleted in	4.2	Superseded by RD-17.	H-P-ASP-CR-0474 (ALS)
§4.3.2.5.4	<b>[ENVT-370 b]</b>	Modified in	4.2	Closure of AI#2 of H-P-ASP-MN-3607.	H-P-ASP-CR-0474 (ALS)
§4.3.2.6.1	<b>[ENVT-390 a]</b>	Modified in	4.2 draft		
§4.3.2.6.1	<b>[ENVT-390 b]</b>	Modified in	4.2	Qualification temperature ranges for units housed in the SVM and seen as CFE by the SVM Contractor: - defined for CCU, according to HP-2-ASED-PS-0022_1_1; - TBD for FOG according to HP-EST-RS-12555_1_0; - updated for VMC according to H-P-1-ASP-SP-0425_1_1.  The responsibility to define the qualification temperature ranges for the SVM units managed by the SVM	H-P-ASP-CR-0474 (ALS)

# ENVIRONMENT AND TESTS REQUIREMENTS (EVTR)

REFERENCE : H-P-1-ASPI-SP-0030

DATE : 07-Oct-2004

ISSUE : 5.0

PAGE : 10/89

§ nb	Req. identifier	Change Status	Doc. issue	Reason of Change	Change Ref.
				Contractor is transferred to the SVM Contractor.	

Issue.	DATE	§ : CHANGE RECORD	AUTHOR
5.0		<p>Update generated with DOORS 5.2 / TREK 3 following:</p> <p>Changes incorporated in this issue have been introduced with the Change Requests:</p> <ul style="list-style-type: none"> <li>- H-P-ASP-CR-0693 (to ASED) and H-P-ASP-CR-0694 (to ALS) dated 7-Oct-2004:</li> </ul> <p>Evolution of H-P-2-ASPI-SP-0030 from issue 4.2 to 5.0.</p> <p>In this issue, the <b>change bars</b> show the paragraphs new or modified <b>since issue 4.2</b>. Requirements deleted in issue 4.2 or before are not displayed.</p> <p><u>Requirements modified in issue 5.0</u> : see list below.</p>	B.Chidaine

## List of requirements modified, deleted or new in issue 5.0

§ nb	Req. identifier	Change Status	Doc. issue	Reason of Change	Change Ref.
§4.2.1	[ENVT-110 c]	Modified in	5.0	Closure of System CDR RID N° MTP-051: deletion of Planck STM.	H-P-ASP-CR-0693 (ASED) H-P-ASP-CR-0694 (ALS)
§4.2.1	[ENVT-113 b]	Modified in	5.0	Closure of System CDR RID N° MTP-051: deletion of Planck STM.	H-P-ASP-CR-0693 (ASED) H-P-ASP-CR-0694 (ALS)
§4.2.2.4	[ENVT-180 a]	Modified in	5.0	Closure of System CDR RID N° DAIV-0313-2.(Shocks).	H-P-ASP-CR-0693 (ASED) H-P-ASP-CR-0694 (ALS)

# ENVIRONMENT AND TESTS REQUIREMENTS (EVTR)

REFERENCE : H-P-1-ASPI-SP-0030

DATE : 07-Oct-2004

ISSUE : 5.0

PAGE : 11/89

## TABLE OF CONTENTS

<b>DISTRIBUTION / DISTRIBUTION RECORD.....</b>	<b>2</b>
<b>ENREGISTREMENT DES EVOLUTIONS / CHANGE RECORD.....</b>	<b>3</b>
<b>TABLE OF CONTENTS.....</b>	<b>11</b>
<b>LIST OF FIGURES AND TABLES .....</b>	<b>13</b>
<b>1. SCOPE.....</b>	<b>15</b>
<b>2. DOCUMENTS .....</b>	<b>16</b>
2.1 APPLICABLE DOCUMENTS .....	16
2.2 REFERENCE DOCUMENTS.....	16
2.2.1 ESA and ARIANESPACE Reference Documents .....	16
2.2.2 Other Reference Documents.....	16
2.3 ACRONYMS.....	17
<b>3. ENVIRONMENTAL DESIGN REQUIREMENTS .....</b>	<b>19</b>
3.1 SPACECRAFT AXES.....	19
3.1.1 Herschel.....	19
3.1.2 PLANCK.....	19
3.2 GROUND OPERATION PHASE .....	20
3.2.1 Mission phase definition .....	20
3.2.2 General requirements .....	20
3.2.3 Mechanical environment.....	21
3.2.4 Thermal and climatic environment.....	22
3.2.4.1 Spacecraft hardware .....	22
3.2.4.2 Transportation .....	22
3.2.4.3 Spacecraft preparation at the launch site.....	23
3.2.5 Other environments.....	23
3.2.5.1 Pressure .....	23
3.2.5.2 Radiation.....	23
3.2.5.3 Micrometeorites .....	23
3.2.5.4 EMC.....	23
3.3 LAUNCH .....	23
3.3.1 Mission phase definition .....	23
3.3.2 Mechanical environment.....	24
3.3.2.1 Quasi-static loads .....	24
3.3.2.2 Low frequency sinusoidal vibrations .....	25
3.3.2.3 Random vibrations .....	25
3.3.2.4 Acoustic noise.....	25
3.3.2.5 Shock.....	26
3.3.3 Thermal environment.....	27
3.3.3.1 Pre-launch phase.....	27
3.3.3.2 Launch phase .....	28
3.3.3.3 Definition of solar, albedo and Earth fluxes .....	31
3.3.4 Other environments.....	34

# ENVIRONMENT AND TESTS REQUIREMENTS (EVTR)

REFERENCE : H-P-1-ASPI-SP-0030

DATE : 07-Oct-2004

ISSUE : 5.0

PAGE : 12/89

3.3.4.1	Pressure .....	34
3.3.4.2	Radiation .....	35
3.3.4.3	Micrometeorites .....	35
3.3.4.4	EMC.....	35
3.4	ON ORBIT PHASE .....	35
3.4.1	Mission phase definition .....	35
3.4.1.1	Initial Orbit Phase (IOP).....	35
3.4.1.2	Commissioning Phase (COP).....	35
3.4.1.3	Performance Verification Phase (PVP) .....	35
3.4.1.4	Routine Operations Phase (ROP).....	36
3.4.2	Mechanical environment.....	36
3.4.3	Thermal environment .....	37
3.4.4	Other environments .....	40
3.4.4.1	Pressure .....	40
3.4.4.2	Radiation .....	40
3.4.4.3	Solid particle environment .....	63
3.4.4.4	EMC.....	64
<b>4.</b>	<b>ENVIRONMENTAL TEST REQUIREMENTS.....</b>	<b>65</b>
4.1	GENERAL.....	65
4.1.1	Ambient conditions .....	65
4.1.2	Accuracy of test apparatus.....	65
4.1.3	Test tolerances .....	65
4.1.4	Cleanliness of test equipment.....	66
4.1.5	Temperature stabilisation.....	67
4.2	SYSTEM AND MODULE LEVEL TESTS .....	68
4.2.1	Environmental test summary.....	68
4.2.2	Mechanical environmental tests .....	71
4.2.2.1	Static test .....	71
4.2.2.2	Sine vibration test levels.....	71
4.2.2.3	Acoustic noise test levels.....	72
4.2.2.4	Shock tests.....	73
4.2.3	Thermal environment tests .....	73
4.2.4	Electromagnetic compatibility tests .....	74
4.3	SUBSYSTEM AND UNIT LEVEL TESTS .....	75
4.3.1	Verification/Test Sequence .....	75
4.3.2	Tests methods.....	76
4.3.2.1	Initial tests .....	76
4.3.2.2	Inspections and examinations .....	76
4.3.2.3	Physical properties .....	77
4.3.2.4	Performance tests.....	78
4.3.2.5	Mechanical environment tests .....	78
4.3.2.6	Thermal environment tests.....	83
4.3.2.7	Operating time .....	86
4.3.3	EMC-tests.....	87
4.4	TEST DOCUMENTATION .....	87
4.4.1	Test Procedures .....	87
4.4.2	Test Reports .....	87
4.4.3	Test Failure.....	87
4.4.4	Failure Definition .....	87
4.4.5	Test Failure Procedures .....	88
	<b>APPENDIX 1 : AEROTHERMAL FLUX NUMERICAL VALUES .....</b>	<b>89</b>

## LIST OF FIGURES AND TABLES

Figure 3-1: Herschel Spacecraft Axes.....	19
Figure 3-3: PLANCK Spacecraft Axis.....	20
Table 3.2-1: Limit Load Factors for Handling and Transportation.....	21
Table 3.2-2: Ambient environment.....	22
Table 3.3-1: Quasi Static Loads (Flight Limit Loads) .....	24
Table 3.3-2: Low Frequency Sinusoidal Vibrations.....	25
Table 3.3-3: Acoustic Environment (Flight Levels) .....	25
Table 3.3-5: Shock Spectrum at launcher interface.....	26
Figure 3-5: Shock Spectrum at launcher interface.....	27
Figure 3-7: Preliminary aerothermal fluxes on ARIANE 5 ECA.....	29
Figure 3-8: Herschel attitude constraints from FJ to launcher separation.....	30
Figure 3-9 :Solar spectral irradiance .....	32
Table 3.3-4: Solar Spectral Irradiance .....	33
Figure 3-10: Variation of static pressure inside fairing .....	34
Table 3.4-1: HERSCHEL constant acceleration .....	36
Table 3.4-2: PLANCK constant acceleration.....	37
Figure 3-12: Herschel attitude constraints in on-orbit phase.....	38
Figure 3-14: Planck attitude constraints .....	39
Figure 3-16: GTO Trapped Electrons Flux.....	44
Table 3.4-3: GTO Trapped Electrons Flux.....	45
Figure 3-18: GTO Trapped Protons Flux.....	45
Table 3.4-4: GTO Trapped Protons Flux.....	45
Figure 3-20: Solar Protons Fluence for the 4 years mission BOM 2007 .....	46
Table 3.4-5: Solar Protons Fluence for the 4 years mission BOM 2007 .....	46
Figure 3-22: Solar Protons Peak Fluxes.....	47
Table 3.4-6: Solar Protons Peak Fluxes.....	47
Figure 3-24: Galactic Cosmic Rays LET spectrum .....	48
Table 3.4-7: Galactic Cosmic Rays LET spectrum .....	49
Figure 3-26: Mission Dose Depth Curve .....	50
Table 3.4-8: Mission Dose Depth Curve .....	51
Figure 3-28: Heavy Ions Induced SEU rate.....	52
Table 3.4-9: Heavy Ions Induced SEU rates .....	53
Figure 3-30: Protons Induced SEU rates.....	54

# ENVIRONMENT AND TESTS REQUIREMENTS (EVTR)

REFERENCE : H-P-1-ASPI-SP-0030

DATE : 07-Oct-2004

ISSUE : 5.0

PAGE : 14/89

Table 3.4-10: Protons Induced SEU rates.....	55
Figure 3-32: Mission DDEF Depth Curves for Si and GaAs detectors.....	56
Table 3.4-11: Mission DDEF Depth Curves for Si and GaAs detectors.....	57
Figure 3-34: Mission 1 MeV electron Equivalent Fluence for PMAX-VOC in Si.....	58
Table 3.4-12: Mission 1 MeV electron Equivalent Fluence for PMAX-VOC in Si.....	58
Figure 3-36: Mission 1 MeV electron Equivalent Fluence for ISC in Si.....	59
Table 3.4-13: Mission 1 MeV electron Equivalent Fluence for ISC in Si.....	59
Figure 3-38: Mission 1 MeV electron Equivalent Fluence for VOC in GaAs.....	60
Table 3.4-14: Mission 1 MeV electron Equivalent Fluence for VOC in GaAs.....	60
Figure 3-40: Mission 1 MeV electron Equivalent Fluence for PMAX in GaAs.....	61
Table 3.4-15: Mission 1 MeV electron Equivalent Fluence for PMAX in GaAs.....	62
Figure 3-42: Mission 1 MeV electron Equivalent Fluence for ISC in GaAs.....	62
Table 3.4-16: Mission 1 MeV electron Equivalent Fluence for ISC in GaAs.....	63
Table 3.4-17: Deleted.....	63
Figure 3-44: Deleted.....	63
Table 4.1-1: Maximum Allowable Test Tolerances.....	66
Table 4.2-1: System environmental test summary.....	69
Table 4.2-4: SVM test plan.....	69
Table 4.2-5: PLM test plan.....	70
Table 4.2-2: Sine vibration levels and duration.....	72
Table 4.2-3: Acoustic test levels and duration.....	73
Table 4.3-1: Sinusoidal Vibration Levels for equipments in Herschel and Planck SVM.....	79
Table 4.3-2: Random levels for the CFE housed in the Herschel SVM.....	80
Figure 4.3-2a: VMC accommodation on Herschel SVM.....	80
Table 4.3-3: Random levels for the CFE housed in the Planck SVM.....	81
Figure 4.3-2b: VMC accommodation on Planck SVM.....	81
Table 4.3-5: Shock qualification levels for the CFE housed in the SVM.....	82
Table 4.3-7: Shock qualification levels at the H-EPLM interface.....	82
Table 4.3-8: Shock qualification levels at the PPLM interface.....	83
Table 4.3-6: Qualification temperatures for the CFE housed in the SVM.....	84
Figure 4-1: Temperature cycling during thermal test.....	85

# ENVIRONMENT AND TESTS REQUIREMENTS (EVTR)

**REFERENCE :** H-P-1-ASPI-SP-0030

**DATE :** 07-Oct-2004

**ISSUE :** 5.0

**PAGE :** 15/89

---

## 1. SCOPE

This specification defines:

- The overall environment to which the satellites, the modules and the units will be subjected from integration until the end of the operational life.
- The test environments to which the satellites, the modules and the units will be submitted to demonstrate their ability to withstand environmental conditions without damage.
- Detailed environment conditions needed for the design of the modules (Herschel and Planck PLM's and Service Module) are given RD-9, RD-10, RD-11 and RD-15.
- Detailed environment conditions for the Instruments are given in the IIDA (see RD-16).

The environmental conditions cover:

- mechanical environment,
- thermal environment,
- other orbit environments (pressure, radiations, micrometeorites ...),
- climatic environment,
- EMC environment,
- cleanliness environment.

## 2. DOCUMENTS

### 2.1 Applicable documents

- AD- 1 HERSCHEL/PLANCK EMC specification.  
H-P-1-ASPI-SP-0037
- AD- 2 HERSCHEL/PLANCK General Design and Interface Requirements  
H-P-1-ASPI-SP-0027
- AD- 3 PA REQUIREMENTS for Subcontractors  
Doc. H-P-1-ASPI-SP-0018
- AD- 4 Deleted
- AD- 5 Deleted
- AD- 6 Deleted
- AD- 7 Deleted
- AD- 8 Deleted
- AD- 9 Deleted
- AD- 10 Solid Particle Environment for Herschel and Planck  
Ref. EMA/02-027/GD/PLCK, 08-Mar-2002, G.Drolshagen, ESA/TOS-EMA

### 2.2 Reference documents

#### 2.2.1 ESA and ARIANESPACE Reference Documents

- RD- 1: ARIANE 5 User's Manual  
Issue 3/Rev 0 Mar 2000
- RD- 2 Deleted
- RD- 3 Deleted
- RD- 4 Deleted
- RD- 5 Deleted
- RD- 12 FIRST L-2 Radiation Environment  
Ref. esa/estec/wma/he/FIRST/3, 04-Mar-1997, H.Evans
- RD- 18 CReMA  
Herschel/Planck Consolidated Report on Mission Analysis  
PT-MA-RP-0010-TOS-GMA

#### 2.2.2 Other Reference Documents

- RD- 6 Design & Development Plan  
H-P-1-ASPI-PL-0009
- RD- 7 Deleted.



# ENVIRONMENT AND TESTS REQUIREMENTS (EVTR)

REFERENCE : H-P-1-ASPI-SP-0030

DATE : 07-Oct-2004

ISSUE : 5.0

PAGE : 17/89

- RD- 8 WMO Spectrum.  
Compilation of the extraterrestrial solar spectrum performed by Christoph Wehrli  
World Radiation Center Davos Dorf, July 1985
- RD- 9 Herschel EPLM Requirements Specification  
H-P-2-ASPI-SP-0250
- RD- 10 Planck PLM Interface and Applicability Specification  
H-P-3-ASPI-IS-0070
- RD- 11 Service Module Interface Specification  
H-P-4-ASPI-IS-0042
- RD- 13 "SHIELDSE : a computer code for space shielding radiation dose calculations"  
S.M. Seltzer, TN-1116 (NBS), 1980.
- RD- 14 NOVICE : A Radiation Transport & Shielding Code, Users Guide  
1990, Thomas. M. Jordan, Experimental & Mathematical Physics Consultant (EMPC).
- RD- 15 Service Module Requirements Specification  
H-P-4-ASPI-SP-0019
- RD- 16 Instrument Interface Document IID Part A  
SCI-PT-IIDA-04624
- RD- 17 SVM Mechanical & Environment Test Specification  
H-P-SP-AI-0033

## 2.3 Acronyms

ACU	Adaptateur Charge Utile (payload adaptor)
CFE	Customer Furnished Equipment
COP	Commissioning Phase
DIP	Disposal Phase
DTCP	Daily Telecommunication Period
EvTR	Environment and Tests Requirements
IOP	Initial Orbit Phase
NCR	Non-Conformance Report
NRB	Non-Conformance Review Board
oop	out of plane
OP	Observation Period
PSD	Power Spectral Density
PVP	Performance Verification Phase
RFD	Request for Deviation
RFW	Request for Waiver
ROP	Routine Operations Phase
SRB	Solid Rocket Booster
SPELTRA	Structure Porteuse Externe Lancement Triple ARIANE (Ariane external carrying structure for triple launch)

# ENVIRONMENT AND TESTS REQUIREMENTS (EVTR)

**REFERENCE :** H-P-1-ASPI-SP-0030

**DATE :** 07-Oct-2004

**ISSUE :** 5.0

**PAGE :** 18/89

---

SYLDA 5	Dual Launch System for Ariane 5 (SYstème de Lancement Double Ariane 5)
TRP	Temperature Reference Point
TRR	Test Readiness Review
USF	Under Short Fairing

## 3. ENVIRONMENTAL DESIGN REQUIREMENTS

### 3.1 SPACECRAFT AXES

#### 3.1.1 *Herschel*

The Herschel satellite reference frame ( $O, X_s, Y_s, Z_s$ ) is defined such that :

- $O$  is located at the centre of the launch vehicle interface ring, on the separation plane.
- $X_s$  coincides with the nominal optical axis of the Herschel telescope. Positive  $X_s$  axis is oriented towards the target source. The  $X_s$  axis coincides with the launcher longitudinal axis.
- $Z_s$  is in the plane orthogonal to the  $X_s$  axis, such that nominally the Sun will lie in the  $(X_s, Z_s)$  plane (zero roll angle with respect to Sun). Positive  $Z_s$  axis is oriented towards the Sun.
- $Y_s$  completes the right handed orthogonal reference frame.

See Figure 3-1.

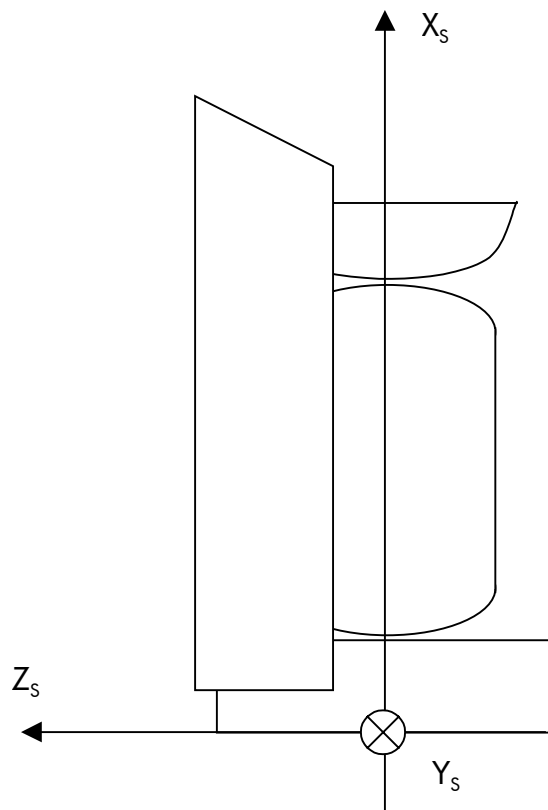

**Figure 3-1: Herschel Spacecraft Axes**

#### 3.1.2 *PLANCK*

The PLANCK satellite reference frame ( $O, X_x, Y_x, Z_x$ ) is defined such that :

- $O$  is located at the center of the launch vehicle interface ring, on the separation plane.

- $X_s$  coincides with the nominal spin axis of PLANCK. Positive  $X_s$  axis is oriented opposite to the Sun in nominal operation. The  $X_s$  axis coincides with the launcher longitudinal axis.
- $Z_s$  is perpendicular to  $X_s$  and contained in the symmetry plane of the telescope, with the positive direction on the concave side of the primary mirror of the telescope.
- $Y_s$  completes the right handed orthogonal reference frame.

See Figure 3-3.

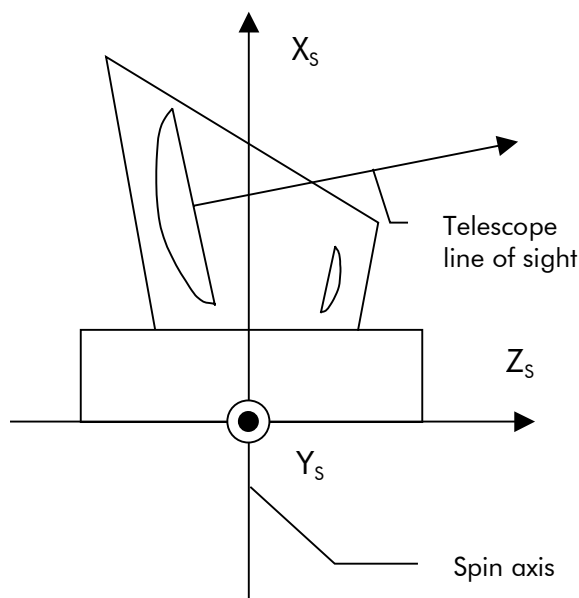

Figure 3-3: PLANCK Spacecraft Axis

## 3.2 GROUND OPERATION PHASE

### 3.2.1 Mission phase definition

This phase includes all ground activities conducted during fabrication, handling, transportation and storage phases.

### 3.2.2 General requirements

# Reference **ENVM-005**

[P:SCI-PT-RS-05991 - Ch.5#5.5.2-SENV-060 H/P  
[P:SCI-PT-RS-05991 - Ch.5#5.5-SENV-005 H/P

On ground, during integration, handling and transportation, the environment, with the exception of bake-out, shall be such as to be significantly less severe than launch and orbit conditions with the exception of the thermal environment of the Cryostat for Herschel and the Planck sorption cooler radiator. (SENV-005)

# \*

# ENVIRONMENT AND TESTS REQUIREMENTS (EVTR)

REFERENCE : H-P-1-ASPI-SP-0030

DATE : 07-Oct-2004

ISSUE : 5.0

PAGE : 21/89

## 3.2.3 Mechanical environment

This section describes the mechanical environment to which the spacecraft hardware is subjected during normal ground operations. These environments shall be controlled so as to be significantly less severe than launch and mission conditions.

# Reference **ENVM-010**

[P:SCI-PT-RS-05991 - Ch.5#5.5.1-SENV-020 H/P

[P:SCI-PT-RS-05991 - Ch.6#6.3.6-SPLM-180 H

Manufacturing, handling and transportation loads (except for the MGSE interface points themselves) as well as test loads shall not be design drivers. (SENV-020)

# \*

The accelerations defined in this paragraph are criteria for shipping container design and equipment used to handle and transport flight hardware.

# Reference **ENVM-020**

The maximum handling and ground transportation load factors on each point of the satellite when the MGSE is subjected to the external environment shall be as given in Table 3.2-1.

# \*

# Reference **ENVM-030 a**

Horizontal and vertical loads shall be considered acting simultaneously for same conditions.

CASES		Applied accelerations (g)
Hoisting	Vertical	-1.3
	Horizontal	±0.2
On integration test fixture with short and slow running	Vertical	-1.1
	Horizontal	±0.2
On dollies and trolleys	Vertical	-1.1
	Horizontal	±0.2
Container Transportation (*)(**)	Vertical	-1 +/- 2
	Horizontal in main moving directions	± 1.5
	Horizontal perpendicular to main moving directions	±1.0

**Table 3.2-1: Limit Load Factors for Handling and Transportation**

(\*) Thermal environments encountered during Hot/Cold transportation (see 3.2.4.2) shall be combined to mechanical loads

(\*\*) First modes of the container fixture are < 10 Hz for any axis.

# ENVIRONMENT AND TESTS REQUIREMENTS (EVTR)

REFERENCE : H-P-1-ASPI-SP-0030

DATE : 07-Oct-2004

ISSUE : 5.0

PAGE : 22/89

Note: negative means downward.

# \*

## 3.2.4 Thermal and climatic environment

### 3.2.4.1 Spacecraft hardware

# Reference **ENVM-035**

[P:SCI-PT-RS-05991 - Ch.5#5.5.2-SENV-060 H/P

The environments under integration, transportation and testing shall not be design drivers. (SENV-060)

# \*

# Reference **ENVM-040 a**

[P:SCI-PT-RS-05991 - Ch.5#5.5.2-SENV-050 H/P

Unless otherwise specified herein, all system and unit manufacturing, handling and test shall be made at ambient conditions as specified in Table 3.2-2.

	Ground operation	Transportation	Storage
Pressure (mbar)	970 to 1050	200 to 1050	970 to 1050
Humidity (%)	40 to 60	40 to 60	40 to 60
Temperature (°C)	22 ± 3	20 ± 10	20 ± 10
Cleanliness	Class 100 000 or better	Class 100 000 or better	Class 100 000 or better

**Table 3.2-2: Ambient environment**

# \*

# Reference **ENVM-050**

[P:SCI-PT-RS-05991 - Ch.5#5.5.3-SENV-065 H/P

The spacecraft shall be designed to withstand a relative humidity (RH) without performance degradation of 40% RH to 65 % RH, non-condensing and for two weeks a relative humidity of 95%, non-condensing. (SENV-065).

# \*

### 3.2.4.2 Transportation

# Reference **ENVM-060 a**

[P:SCI-PT-RS-05991 - Ch.5#5.5.2-SENV-050 H/P

# ENVIRONMENT AND TESTS REQUIREMENTS (EVTR)

REFERENCE : H-P-1-ASPI-SP-0030

DATE : 07-Oct-2004

ISSUE : 5.0

PAGE : 23/89

The transport devices shall be capable of maintaining the spacecraft hardware within the ambient environment defined in section 3.2.4.1 when subjected to the following uncontrolled atmospheric conditions as defined below:

- Temperature: transportation and storage ambient temperature extremes to which containers will be exposed, while providing protection for specimen, shall be within  $-25^{\circ}\text{C}$  and  $+60^{\circ}\text{C}$ .
- Humidity :  $1\% < \text{RH} < 100\%$
- Pressure : pressure changes during air transportation, from 1050 hPa (sea level) to 15000 m altitude.

# \*

## 3.2.4.3 Spacecraft preparation at the launch site

# Reference **ENVM-70**

[P:SCI-PT-RS-05991 - Ch.5#5.5.2-SENV-040 H/P

The constraints applicable to the spacecraft preparation at the launch site shall be derived from RD- 1. (SENV-040)

# \*

## 3.2.5 Other environments

### 3.2.5.1 Pressure

See section 3.2.4.

### 3.2.5.2 Radiation

No specific radiation environment for this phase

### 3.2.5.3 Micrometeorites

No specific micrometeorites environment for this phase

### 3.2.5.4 EMC

The satellites shall be designed to meet the requirements specified in AD- 1.

## 3.3 LAUNCH

### 3.3.1 Mission phase definition

The launch phase starts at the umbilical removal and lasts up to the separation of the satellite.

The launcher is an ARIANE 5 - ECA with long fairing and SYLDA 5. It will follow a sub-optimum ascent to shift the line of apsides by between  $7.5^{\circ}$  and  $15^{\circ}$  (perigee Eastward shift).

The Planck satellite will be in lower position :

# ENVIRONMENT AND TESTS REQUIREMENTS (EVTR)

REFERENCE : H-P-1-ASPI-SP-0030

DATE : 07-Oct-2004

ISSUE : 5.0

PAGE : 24/89

- on top of ACU 2624
- without USF

The Herschel satellite will be in upper position :

- on top of the SYLDA 5
- on top of ACU 2624

Once injection to L<sub>2</sub> is performed, HERSCHEL is separated in 3 axis mode with its Z<sub>s</sub> axis oriented towards Sun. Then the ARIANE upper stage re-orient itself and spins up in order to separate PLANCK in spinned mode (1 rpm, TBC) with its X<sub>s</sub> axis opposite to Sun.

## 3.3.2 Mechanical environment

During flight, the Satellites are subjected to static and dynamic loads induced by the launch vehicle.

Such excitation may be of aerodynamic origin (wind gust, buffeting at transonic velocity) or due to the propulsion systems (longitudinal acceleration, thrust build-up of tail off transient, structure-propulsion coupling, attitude control limit cycling, etc...).

### 3.3.2.1 Quasi-static loads

# Reference **ENVM-085**

[P:SCI-PT-RS-05991 - Ch.5#5.5.1-SENV-030 H/P

The steady state and low frequency dynamic loads are quantified by the combined loads (also called Quasi-Static Loads: QSL). The most critical flight events are the resulting Flight Limit Loads are given in Table 3.3-1 as far as the Satellites complies with the frequency requirements :

- First lateral frequency > 9 Hz
- First longitudinal frequency > 31 Hz

Flight Event	Acceleration (g)		
	Longitudinal		Lateral
	Herschel	Planck	
Lift-off	-1.7 g ± 1.5 g	-1.7 g ± 1.5 g	± 2.0 g
Maximum dynamic pressure	-2.7 g ± 0.5 g	-2.7 g ± 0.5 g	± 2.0 g
SRB end of flight	-4.55 g ± 1.45 g	-4.55 g ± 1.45 g	± 1.0 g
Main Core Thrust Tail-off	-0.2 g ± 1.4 g	-0.2 g ± 1.4 g	± 0.25 g
Max tension case: SRB jettisoning	+2.5 g	+2.5 g	± 0.9 g

**Table 3.3-1: Quasi Static Loads (Flight Limit Loads)**

# \*

Notes :

- The minus sign with longitudinal axis values indicates compression.



# ENVIRONMENT AND TESTS REQUIREMENTS (EVTR)

REFERENCE : H-P-1-ASPI-SP-0030

DATE : 07-Oct-2004

ISSUE : 5.0

PAGE : 25/89

- The lateral loads may act in any direction simultaneously with longitudinal loads.
- The Quasi-Static-Loads apply on centre of gravity of the satellite.
- The over line loads flux induced by the launcher and which the SVM Primary Structure shall be designed to withstand are specified in IML-060-H for Herschel and IML-070-P for Planck (see RD-11).

## 3.3.2.2 Low frequency sinusoidal vibrations

The sinusoidal vibration acceptance level at the base of the Satellites is given in Table 3.3-2. These spectra take into account any sinusoidal or transient vibrations inside the given bandwidth.

Axis	Frequency range [Hz]	Acceptance level (0-peak)
Longitudinal	5 - 100	1.0 g
Lateral	5 - 25	0.8 g
	25 - 100	0.6 g

**Table 3.3-2: Low Frequency Sinusoidal Vibrations**

## 3.3.2.3 Random vibrations

Random vibrations are transmitted by the launcher to the satellite via the launch vehicle/satellite structure interface. They are generated in the launcher by motion of some mechanical parts, combustion phenomena or structural elements excited by the acoustic environment (see below)

## 3.3.2.4 Acoustic noise

The highest acoustic environment occurs at lift-off and during transonic flight. Outside these periods it is substantially lower. The flight level of acoustic environment are given in Table 3.3-3.

Octave Band Central Frequency [Hz]	Flight Level [dB]
31.5	128
63	130
125	135
250	139
500	134
1000	128
2000	124

**Table 3.3-3: Acoustic Environment (Flight Levels)**

# ENVIRONMENT AND TESTS REQUIREMENTS (EVTR)

REFERENCE : H-P-1-ASPI-SP-0030

DATE : 07-Oct-2004

ISSUE : 5.0

PAGE : 26/89

Acoustic environment will not be modulated taking into account filling ratio (see §4.6.1.3 of the A5-UM [RD-1]) since level uncertainty is covered by test tolerance.

## 3.3.2.5 Shock

# Reference **ENVM-130**

[P:SCI-PT-RS-05991 - Ch.5#5.5.1-SENV-030 H/P

The Satellites are subjected to shocks during interstage separation, fairing and carrying structures jettisoning and on actual spacecraft separation. On ARIANE 5, the fairing and the cryogenic stage/upper stage separation shocks are noticeable at the spacecraft interface. The envelope of actual spacecraft separation environment and shocks generated during the flight has to be considered (see Table 3.3-5 and its graphical representation on the H&P curve of Figure 3-5).

Frequency [Hz]	Shock at launcher interface [g]
100	20
340	430
1 100	2 900
10 000	2 900

**Table 3.3-5: Shock Spectrum at launcher interface**

### shock specification for Herschel-Planck

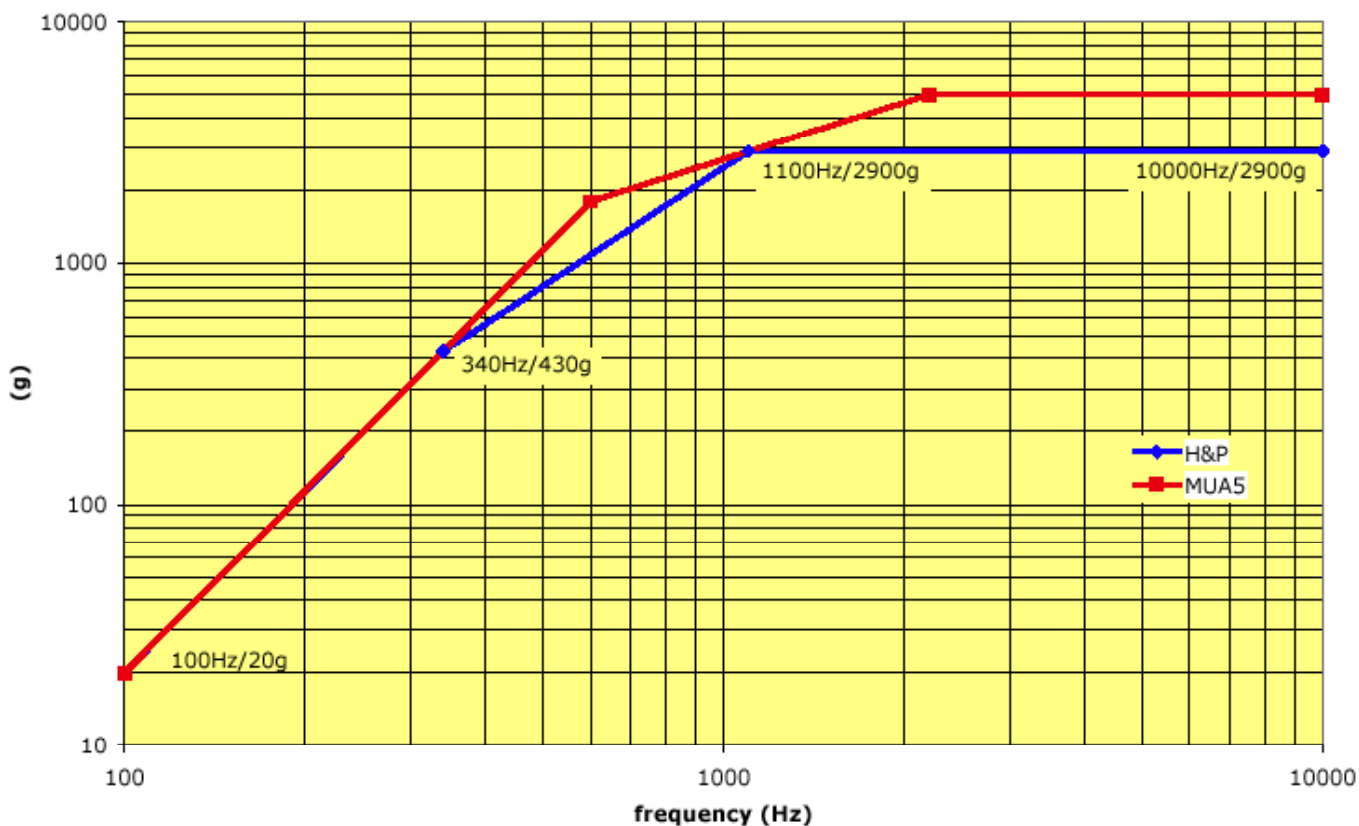

Figure 3-5: Shock Spectrum at launcher interface

# \*

### 3.3.3 Thermal environment

#### 3.3.3.1 Pre-launch phase

# Reference **ENVM-140 b**

[P:SCI-PT-RS-05991 - Ch.5#5.5.2-SENV-045 H/P

The temperature of the air injected inside the fairing on the launch pad is adjustable between 10°C and 25°C. The other characteristics of this class 100 00 cleanliness environment are :

- Relative humidity :  $\leq 55\%$
- Filtration : 0.3  $\mu\text{m}$
- Main air velocity :  $\leq 2 \text{ m/s}$
- Noise :  $\leq 94 \text{ dB}$  (also inside SYLDA 5)

(RD-1).

# \*

# ENVIRONMENT AND TESTS REQUIREMENTS (EVTR)

REFERENCE : H-P-1-ASPI-SP-0030

DATE : 07-Oct-2004

ISSUE : 5.0

PAGE : 28/89

## 3.3.3.2 Launch phase

### Aerothermal flux

# Reference **ENVM-150**

From launch time to fairing jettison, the Herschel satellite and its modules shall be able to support a net flux density radiated by the fairing  $\leq 1000$  W/m<sup>2</sup> at any point [RD-1].

# \*

# Reference **ENVM-160**

From fairing jettison to the separation of Herschel from the launcher, the Herschel satellite and its modules shall be able to support an aerothermal flux  $\leq 1135$  W/m<sup>2</sup> at any point [RD-1].

# \*

# Reference **ENVM-165 b**

[P:SCI-PT-RS-05991 - Ch.5#5.5.2-SENV-045 H/P

From launch time to the separation of Planck from the launcher, the Planck satellite and its modules shall be able to support a net flux density radiated by SYLDA 5  $\leq 1000$  W/m<sup>2</sup> at any point [RD-1].

# \*

### Notes :

- The maximum aerothermal flux of 1135 W/m<sup>2</sup> applies to Herschel only and on a plane normal to the trajectory. As shown on Figure 3-7, it occurs at fairing jettison.
- Figure 3-7 shows also that a second flux peak below 600 W/m<sup>2</sup> will occur after fairing jettisoning at between 600 s and 700 s. The launch scenario to be considered corresponds to the worst case between curves "w\_opt - 7.5°" and "w\_opt - 15°" depending on the thermal constants of the considered elements (mainly MLI).
- Figure 3-7 is based on the numerical values provided in Appendix 1.
- After fairing jettisoning, Herschel is subjected to solar, albedo and earth fluxes, defined in section 3.3.3.3, whereas Planck remains protected by SYLDA 5.

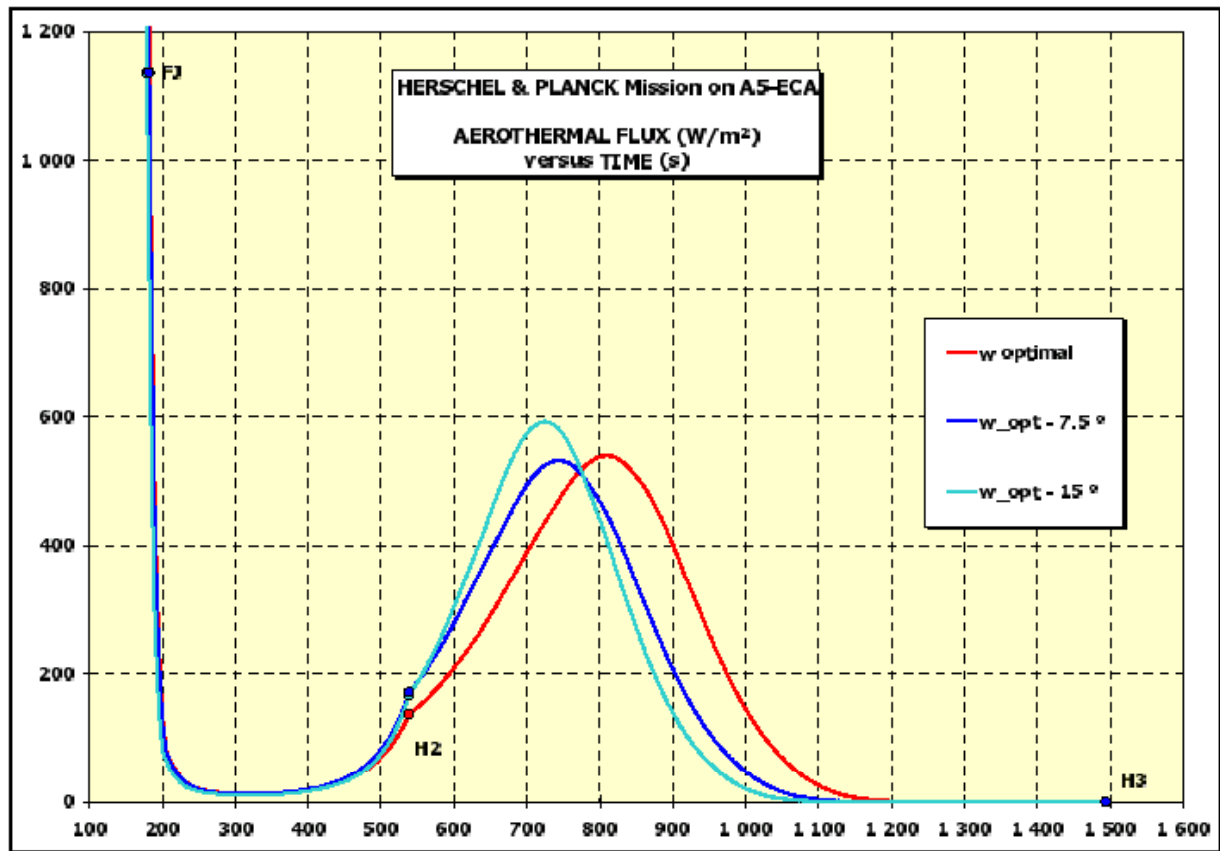

**Figure 3-7: Preliminary aerothermal fluxes on ARIANE 5 ECA**

Sun Aspect Angle :

# Reference **ENVM-170 a**

[P:SCI-PT-RS-05991 - Ch.4#4.2.3.1-MISS-040 H/P  
[P:H-P-2-ASPI-SP-0250#3.1.2.1-HERS-0050 b

From fairing jettison to launcher separation, the Herschel satellite and its modules shall be compatible with a Sun centre direction :

- between  $-26^\circ$  and  $+26^\circ$  from the (Xs, Zs) plane and
- between  $+50^\circ$  and  $+140^\circ$  from the +Xs axis.

# \*

Notes :

- These allowed Sun directions define a solid angle in the satellite reference frame (see Figure 3-8).
- This solid angle can be scanned by the image of Xs after a combination of 2 rotations :
  - rotation around +Xs with an angle between  $-26^\circ$  and  $+26^\circ$  ("roll"). +Ys becomes +Ys'.
  - then rotation around +Ys' with an angle between  $+50^\circ$  and  $+140^\circ$  ("pitch").

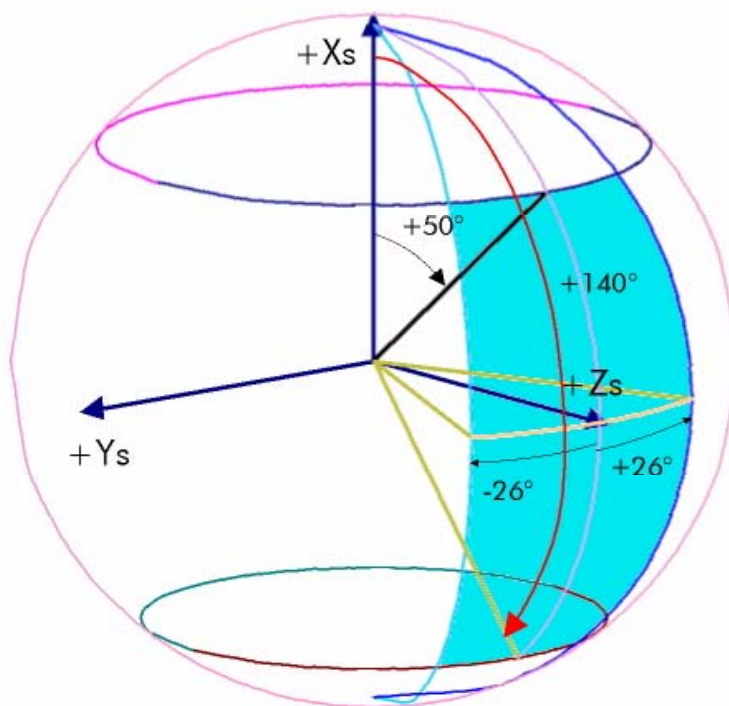

**Figure 3-8: Herschel attitude constraints from FJ to launcher separation**

# Reference **ENVM-175 a**

[P:SCI-PT-RS-05991 - Ch.4#4.2.3.1-MISS-040 H/P

[P:H-P-2-ASPI-SP-0250#3.1.2.1-HERS-0052 b

From fairing jettison to launcher separation, the H-SVM shall be compatible with one 360° rotation of the launcher around its X axis in the following conditions:

- Altitude: 100 km
- Albedo: 0.53
- Launcher spin rate: 0.5 °/s
- saa in pitch: 50° to 120° (/X<sub>HSC</sub> axis)
- X<sub>HSC</sub> axis perpendicular to the (Earth centre, S/C origin) direction

# \*

# Reference **ENVM-180**

[P:H-P-2-ASPI-SP-0250#3.1.2.1-HERS-0055 a

[P:SCI-PT-RS-05991 - Ch.4#4.2.3.1-MISS-040 H/P

At launcher separation, Herschel spacecraft will be nominally Sun pointed with Zs axis towards Sun. Due to tip-off rates at separation, Herschel shall be compatible with a transient rotation of maximum 2 minutes :

- maximum amplitude of 15° around Xs ; Ys and Zs become Ys' and Zs'.
- then maximum amplitude of 25° around Ys' ; Zs' become Zs''.
- and finally maximum amplitude of 25° around Zs''.

# ENVIRONMENT AND TESTS REQUIREMENTS (EVTR)

REFERENCE : H-P-1-ASPI-SP-0030

DATE : 07-Oct-2004

ISSUE : 5.0

PAGE : 31/89

# \*

## Eclipses :

# Reference **ENVM-190 a**

[P:SCI-PT-RS-05991 - Ch.4#4.2.3.1-MISS-035 H/P

The transfer trajectory will be defined such that no eclipse (Sun total or partial eclipse by Earth) will occur from separation to the nominal orbit (MISS-035 H/P).

# \*

## 3.3.3.3 Definition of solar, albedo and Earth fluxes

### Solar constant :

# Reference **ENVM-200**

The value of the solar constant (radiation that falls on a unit area of surface normal to the line from the Sun, per unit time, outside the atmosphere) at 1 AU (1,49598 10<sup>8</sup> km) is 1371 W/m<sup>2</sup>. The solar constant has an uncertainty of about  $\pm 10$  W/m<sup>2</sup>.

# \*

### Variation with distance :

# Reference **ENVM-210**

At heliocentric distances different from 1 AU, the solar irradiance  $q$  is such that

$$q = \frac{1371}{d^2} \text{ W / m}^2$$

where  $d$  is the heliocentric distance in AU.

# \*

The evolution of the distance Earth - Spacecraft with time is described in §3.2 of RD-18.

Solar spectrum (source : RD-8) :

# Reference **ENVM-220**

The solar spectral irradiance is defined in Figure 3-9.

A part of the numerical values used to plot this figure is given in Table 3.3-4.

$\lambda$  : wavelength [ $\mu\text{m}$ ]

$E_\lambda$  : solar spectral irradiance averaged over small bandwidth centered at  $\lambda$  [ $\text{W m}^{-2} \mu\text{m}^{-1}$ ]

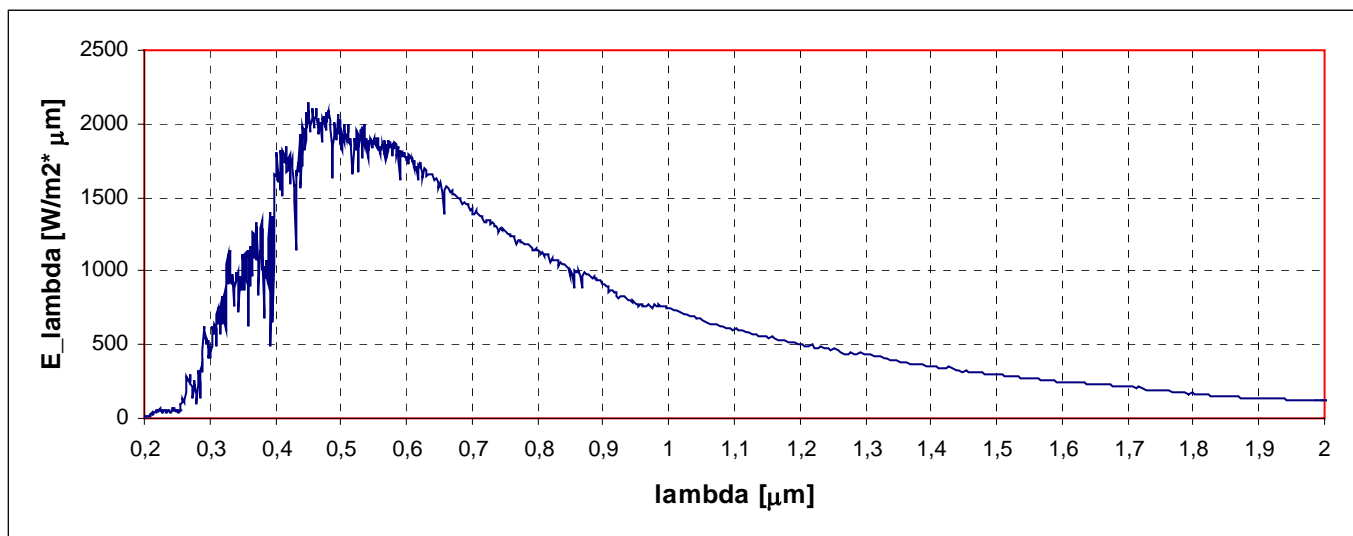

**Figure 3-9 :Solar spectral irradiance**



# ENVIRONMENT AND TESTS REQUIREMENTS (EVTR)

REFERENCE : H-P-1-ASPI-SP-0030

DATE : 07-Oct-2004

ISSUE : 5.0

PAGE : 33/89

$\lambda$ [ $\mu\text{m}$ ]	$E_\lambda$ [W.m-2. $\mu\text{m}^{-1}$ ]	$\lambda$ [ $\mu\text{m}$ ]	$E_\lambda$ [W.m-2. $\mu\text{m}^{-1}$ ]	$\lambda$ [ $\mu\text{m}$ ]	$E_\lambda$ [W.m-2. $\mu\text{m}^{-1}$ ]	$\lambda$ [ $\mu\text{m}$ ]	$E_\lambda$ [W.m-2. $\mu\text{m}^{-1}$ ]	$\lambda$ [ $\mu\text{m}$ ]	$E_\lambda$ [W.m-2. $\mu\text{m}^{-1}$ ]
0,20	7	0,71	1 387	1,22	481	1,73	190	2,36	65
0,21	28	0,72	1 332	1,23	484	1,74	191	2,38	55
0,22	48	0,73	1 327	1,24	477	1,75	187	2,40	54
0,23	56	0,74	1 259	1,25	474	1,76	184	2,42	57
0,24	43	0,75	1 263	1,26	444	1,77	177	2,44	51
0,25	59	0,76	1 238	1,27	439	1,78	171	2,47	53
0,26	102	0,77	1 205	1,28	435	1,79	169	2,49	54
0,27	293	0,78	1 188	1,29	442	1,80	169	2,52	47
0,28	112	0,79	1 159	1,30	438	1,81	160	2,54	46
0,29	623	0,80	1 143	1,31	419	1,82	159	2,57	44
0,30	403	0,81	1 115	1,32	416	1,83	156	2,59	42
0,31	495	0,82	1 081	1,33	405	1,84	153	2,62	41
0,32	712	0,83	1 069	1,34	398	1,85	148	2,64	39
0,33	1 144	0,84	1 045	1,35	387	1,86	143	2,67	38
0,34	992	0,85	1 003	1,36	378	1,87	135	2,70	36
0,35	1 119	0,86	997	1,37	369	1,88	140	2,73	35
0,36	979	0,87	986	1,38	364	1,89	137	2,76	34
0,37	1 075	0,88	960	1,39	358	1,90	133	2,80	32
0,38	1 289	0,89	944	1,40	353	1,91	138	2,83	31
0,39	1 223	0,90	905	1,41	346	1,92	134	2,87	29
0,40	1 649	0,91	870	1,42	343	1,93	132	2,91	28
0,41	1 502	0,92	830	1,43	337	1,94	129	2,95	26
0,42	1 760	0,93	826	1,44	327	1,95	126	2,99	25
0,43	1 136	0,94	800	1,45	323	1,96	126	3,03	24
0,44	1 715	0,95	778	1,46	317	1,97	125	3,08	23
0,45	2 146	0,96	767	1,47	311	1,98	125	3,13	21
0,46	2 042	0,97	763	1,48	303	1,99	121	3,18	20
0,47	1 879	0,98	762	1,49	303	2,00	116	3,24	19
0,48	2 037	0,99	764	1,50	296	2,01	114	3,30	18
0,49	2 009	1,00	745	1,51	290	2,02	113	3,36	16
0,50	1 859	1,01	734	1,52	286	2,03	110	3,43	15
0,51	1 949	1,02	704	1,53	282	2,04	107	3,50	14
0,52	1 833	1,03	688	1,54	275	2,05	104	3,58	13
0,53	1 954	1,04	681	1,55	273	2,06	100	3,67	12
0,54	1 772	1,05	661	1,56	269	2,08	101	3,76	11
0,55	1 864	1,06	642	1,57	260	2,09	98	3,86	10
0,56	1 845	1,07	638	1,58	255	2,11	93	3,97	9
0,57	1 772	1,08	620	1,59	246	2,12	87	4,09	8
0,58	1 840	1,09	612	1,60	247	2,14	85	4,23	7
0,59	1 815	1,10	608	1,61	244	2,15	81	4,39	6
0,60	1 748	1,11	603	1,62	240	2,17	80	4,58	5
0,61	1 705	1,12	579	1,63	241	2,18	75	4,81	4
0,62	1 736	1,13	566	1,64	234	2,20	73	5,09	3
0,63	1 641	1,14	557	1,65	234	2,21	75	5,45	2
0,64	1 616	1,15	545	1,66	233	2,23	75	5,93	2
0,65	1 608	1,16	540	1,67	228	2,25	72	6,62	1
0,66	1 573	1,17	533	1,68	221	2,26	71	7,79	1
0,67	1 518	1,18	514	1,69	219	2,28	69	10,08	0
0,68	1 494	1,19	511	1,70	217	2,30	66		
0,69	1 450	1,20	496	1,71	203	2,32	53		
0,70	1 388	1,21	489	1,72	205	2,34	58		

Table 3.3-4: Solar Spectral Irradiance

# \*

Earth Albedo :

# ENVIRONMENT AND TESTS REQUIREMENTS (EVTR)

REFERENCE : H-P-1-ASPI-SP-0030

DATE : 07-Oct-2004

ISSUE : 5.0

PAGE : 34/89

# Reference **ENVM-230**

Albedo is the fraction of incident sunlight which is reflected back into space. The amount of reflected sunlight varies with many factors such as cloud cover, type of terrain, vegetation, presence of water and season. So, it is practical to use an average value for the albedo. A value of  $0.3 \pm 0.05$  shall be used.

# \*

## Earth Infrared Thermal radiation

# Reference **ENVM-240**

The Earth Infrared radiation shall be assumed to be that of a black body with a characteristic temperature of 288 K. The average infrared radiation emitted by Earth is  $230 \text{ W/m}^2$ , with variations between  $150 \text{ W/m}^2$  and  $350 \text{ W/m}^2$ .

# \*

## **3.3.4 Other environments**

### 3.3.4.1 Pressure

# Reference **ENVM-250**

[P:SCI-PT-RS-05991 - Ch.5#5.5.4-SENV-075 H/P

The spacecraft and their modules shall be designed to withstand the depressurisation profile defined in Figure 3-10. The slope of pressure variation is 20 mbar/s during the launch vehicle ascent phase with locally 45 mbar/s during the transonic phase. (SENV-075)

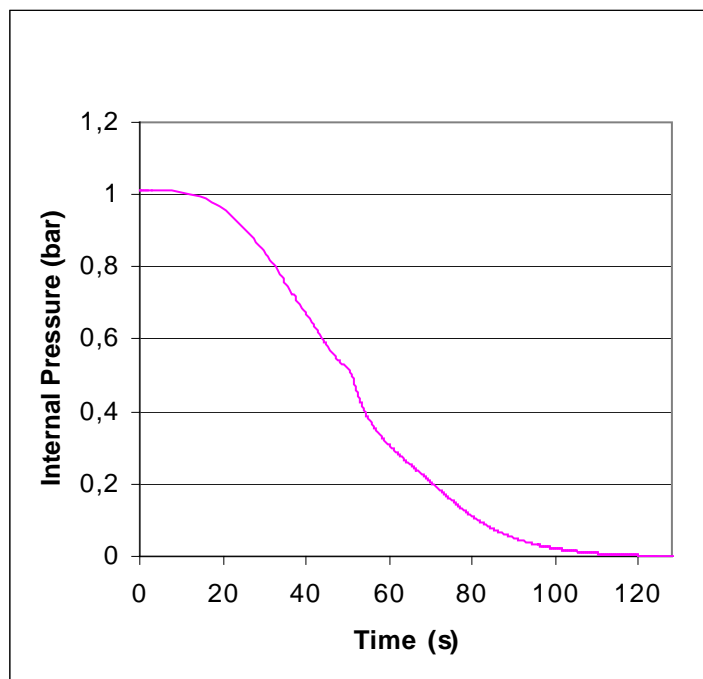

**Figure 3-10: Variation of static pressure inside fairing**

# \*

## 3.3.4.2 Radiation

See section 3.4.4.2.

## 3.3.4.3 Micrometeorites

See section 3.4.4.3.

## 3.3.4.4 EMC

The satellites shall be designed to meet the requirements specified in AD- 1.

## 3.4 ON ORBIT PHASE

### 3.4.1 Mission phase definition

The on-orbit phase starts at satellite separation from launcher. It can be split into the following subphases :

- transfer from Earth to L<sub>2</sub>:
  - initial orbit phase (IOP),
  - commissioning phase (COP),
  - performance verification phase (PVP),
- orbit around L<sub>2</sub>:
  - Routine Operations Phase (ROP),
  - Disposal Phase (DIP).

Activities during the on-orbit phase are described in the following sections.

#### 3.4.1.1 Initial Orbit Phase (IOP)

This phase starts at satellite separation from launcher. This phase is devoted to initial Sun acquisition, establishment of contact with ground stations, post launch satellite health check, performance of first orbit corrections to take place after injection on transfer from Earth to L<sub>2</sub>.

#### 3.4.1.2 Commissioning Phase (COP)

During this phase, functional check-out of the spacecraft is performed as well as performance verification of subsystems (power, data handling, telecommunications, thermal control).

Decontamination heating of HERSCHEL and PLANCK (TBC) telescopes is performed during this phase. When the decontamination heaters are switched OFF, cool down of the Payload Modules can begin. When the payload instruments have reached their operational temperature, they can be switched ON and functional verification can be conducted.

#### 3.4.1.3 Performance Verification Phase (PVP)

During this phase Payload calibration in all modes in relation with spacecraft Attitude Control Subsystem will be performed.

# ENVIRONMENT AND TESTS REQUIREMENTS (EVTR)

REFERENCE : H-P-1-ASPI-SP-0030

DATE : 07-Oct-2004

ISSUE : 5.0

PAGE : 36/89

## 3.4.1.4 Routine Operations Phase (ROP)

All the phases described in the previous paragraph (Initial orbit phase, commissioning, performance verification) occur during the transfer to the final orbit around  $L_2$ . The cumulated duration of these phases is less than 6 months.

To reach the final orbit around  $L_2$ , no manoeuvre is required for Herschel. So, it can enter in Routine Operations Phase in order to begin its scientific operation as soon as the Performance Verification Phase is finished.

On the contrary, PLANCK has to perform an injection manoeuvre to reach its small Lissajous orbit around  $L_2$ . Routine Operations Phase can begin after this manoeuvre.

During Routine Operations Phase, the day is shared between Observation Period (OP) and Daily Telecommunication Period (DTCP):

- During OP, both spacecraft autonomously perform scientific observation according to an observation plan which has been loaded during a previous ground contact. Scientific and housekeeping data are stored in the mass memory.
- During DTCP, the spacecraft dumps the mass memory contents to the ground. On PLANCK scientific operations continue during ground contact. On HERSCHEL, scientific activity will be limited by the attitude constraints imposed by the establishment of a link to the ground. In both cases, real time scientific and housekeeping data can be transmitted to ground in parallel to memory dump. During DTCP, the observation/spacecraft schedule parameters for subsequent days are uplinked, while some housekeeping tasks (e.g. wheel unloading) are performed.

## 3.4.2 Mechanical environment

### Steady state accelerations

# Reference **ENVM-260**

[P:SCI-PT-RS-05991 - Ch.5#5.5.2-SENV-055 H/P

The PLANCK spacecraft is a spinner at 1 rpm along its  $X_s$  axis. This will generate a very low steady state acceleration of  $0.01 \text{ m/s}^2$  at 1 m from the spin axis.

# \*

# Reference **ENVM-270**

[P:SCI-PT-RS-05991 - Ch.5#5.5.2-SENV-055 H/P

The maximum in-orbit acceleration applied to the Spacecraft Centre of Mass are defined in Table 3.4-1 for HERSCHEL and Table 3.4-2 for PLANCK

HERSCHEL	Acceleration ( $\text{m/s}^2$ )	Rotational acceleration ( $\text{rad/s}^2$ )
$X_s$	< 0.03	TBD
$Y_s$	< 0.03	TBD
$Z_s$	< 0.03	TBD

**Table 3.4-1: HERSCHEL constant acceleration**

# ENVIRONMENT AND TESTS REQUIREMENTS (EVTR)

REFERENCE : H-P-1-ASPI-SP-0030

DATE : 07-Oct-2004

ISSUE : 5.0

PAGE : 37/89

PLANCK	Acceleration (cm/s <sup>2</sup> )	Rotational acceleration (rad/s <sup>2</sup> )
X <sub>s</sub>	-2.0 < X < +4.5	TBD
Y <sub>s</sub>	-1.0 < Y < +1.0	TBD
Z <sub>s</sub>	-4.0 < Z < 0	TBD

**Table 3.4-2: PLANCK constant acceleration**

# \*

## 3.4.3 Thermal environment

# Reference **ENVM-280 a**

[P:SCI-PT-RS-05991 - Ch.5#5.5.2-SENV-055 H/P

During on-orbit operation, the satellite is subjected to solar, albedo and earth fluxes, defined in section 3.3.3.3.

- The maximum S/C to Earth distance is 1.8 10<sup>6</sup> km.
- S/C to Sun distance is between 147 10<sup>6</sup> km and 154 10<sup>6</sup> km in any phase.
- The minimum S/C to Sun distance when the S/C is in Routine Operations Phase is 148.3 10<sup>6</sup> km.

# \*

Sun Aspect Angle :

# Reference **ENVM-290**

[P:H-P-2-ASPI-SP-0250#3.1.4-HERS-0090 a

[P:SCI-PT-RS-05991 - Ch.4#4.2.7-MISS-110 H

During all Herschel mission phases and operational modes, Herschel shall be compatible with a Sun direction :

- between -1° and +1° from the (X<sub>s</sub>, Z<sub>s</sub>) plane and
- between +60° and +120° from the +X<sub>s</sub> axis.

# \*

Notes :

- These allowed Sun directions define a solid angle in the satellite reference frame (see Figure 3-12).
- This solid angle can be scanned by the image of X<sub>s</sub> after a combination of 2 rotations :
  - rotation around +X<sub>s</sub> with an angle between -1° and +1° ("roll"). +Y<sub>s</sub> becomes +Y<sub>s</sub>'.
  - then rotation around +Y<sub>s</sub>' with an angle between +60° and +120° ("pitch").

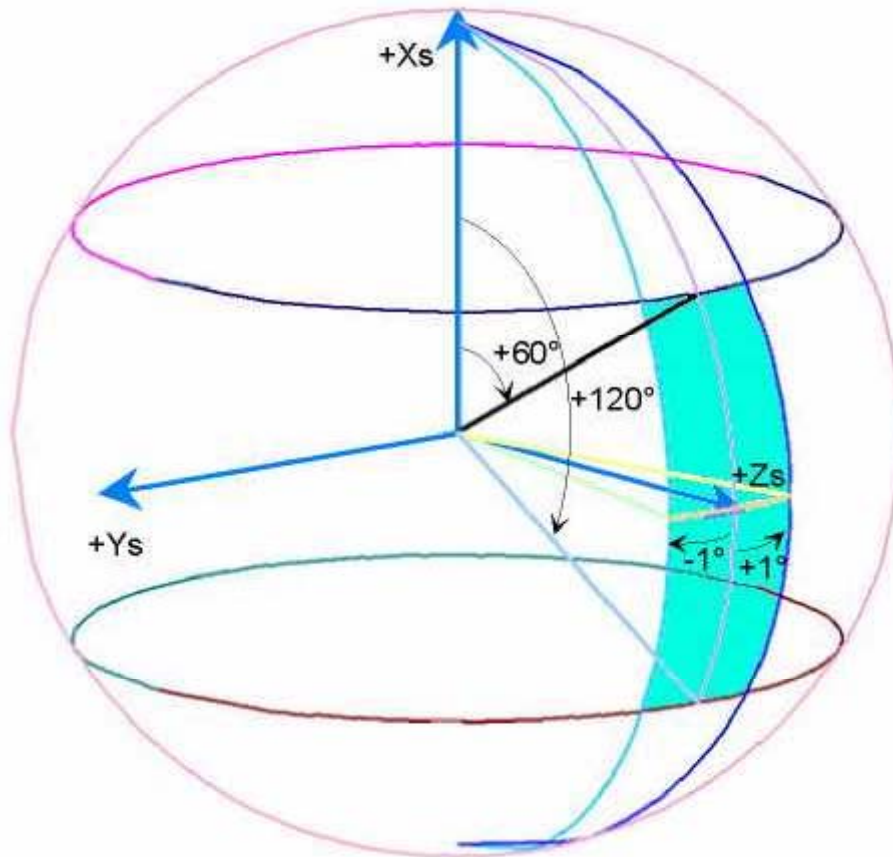

**Figure 3-12: Herschel attitude constraints in on-orbit phase**

# Reference **ENVM-300**

[P:H-P-2-ASPI-SP-0250#3.1.4-HERS-0095 a  
[P:SCI-PT-RS-05991 - Ch.4#4.2.7-MISS-110 H

In contingency cases during Herschel mission phases and operational modes, Herschel shall be compatible with a Sun direction :

- between  $-10^\circ$  and  $+10^\circ$  from the (Xs, Zs) plane and
- between  $+55^\circ$  and  $+125^\circ$  from the +Xs axis.

Maximum duration of transient is 1 minute.

# \*

Notes :

- These allowed Sun directions define a solid angle in the satellite reference frame.
- This solid angle can be scanned by the image of Xs after a combination of 2 rotations :
  - rotation around +Xs with an angle between  $-10^\circ$  and  $+10^\circ$  ("roll"). +Ys becomes +Ys'.
  - then rotation around +Ys' with an angle between  $+55^\circ$  and  $+125^\circ$  ("pitch").

# Reference **ENVM-310**

[P:SCI-PT-RS-05991 - Ch.5#5.5.2-SENV-055 H/P

**PLANCK** : during all PLANCK mission phases and operational modes, the Sun will be maintained at 10 deg from the spin axis (see Figure 3-14).

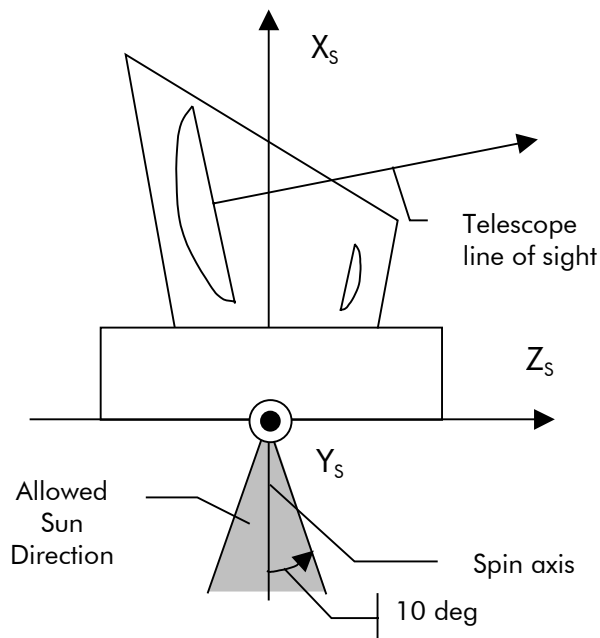

**Figure 3-14: Planck attitude constraints**

# \*

Angle between spin axis and Earth

# Reference **ENVM-320**

[P:SCI-PT-RS-05991 - Ch.5#5.5.2-SENV-055 H/P

During PLANCK mission, the spin axis ( $X_s$ ) can be depointed by  $10^\circ$  off Sun. This however will be done such that the Earth aspect angle (angle between the  $-X_s$  and the Earth direction) remain below  $15^\circ$ .

# \*

Eclipses :

# Reference **ENVM-330**

[P:SCI-PT-RS-05991 - Ch.5#5.5.2-SENV-055 H/P

On their Lissajous orbits, the HERSCHEL and PLANCK spacecraft will be well outside the Earth's shadow so that no eclipse will occur during their lifetimes.

# \*

Note: Moon transit can occur as described in RD-18 and specified in RD-15.

## 3.4.4 Other environments

### 3.4.4.1 Pressure

# Reference **ENVM-340**

[P:SCI-PT-RS-05991 - Ch.5#5.5.4-SENV-070 H/P

The spacecraft and their modules shall be designed to withstand any external air pressure between ambient (0.105 MPa) and free space vacuum ( $<10^{-4}$  Pa). (SENV-070)

# \*

### 3.4.4.2 Radiation

The HERSCHEL and PLANCK spacecraft, which will conduct their mission around the L2 Lagrange point of the Earth/Sun system, will be submitted to a relatively benign radiation environment. This is due, in particular, to the fact that the spacecraft will only be exposed to trapped particles during the launch phase. They will be however exposed to energetic protons and heavy ions from solar flares and galactic cosmic rays.

Similarly, as L2 is outside the Earth magnetosphere, plasma is basically the one contained in solar wind. So surface charging potential is expected to be low.

The principal anticipated radiation effects are :

- Degradation of electronic components, detectors and materials (dose effect).
- Interference with detector operation (background).
- Latch-up.
- Electrostatic charging.

#### 3.4.4.2.1 Space Radiation Environment description

# Reference **ENVM-370**

[P:SCI-PT-RS-05991 - Ch.5#5.5.5.3-SENV-111 H/P

The minimum allowable radiation level for active parts shall be :

Minimum Total Dose Behavior	10 krad (Si)
Minimum Displacement Damage Equivalent Fluence (Si)	$6 \cdot 10^9$ 10 MeV p/cm <sup>2</sup>
Minimum Displacement Damage Equivalent Fluence (GaAs)	$5 \cdot 10^9$ 10 MeV p/cm <sup>2</sup>

#### 3.4.4.2.1.1 Trapped Electrons

# Reference **ENVM-380**

[P:SCI-PT-RS-05991 - Ch.5#5.5.5.3-SENV-111 H/P



# ENVIRONMENT AND TESTS REQUIREMENTS (EVTR)

REFERENCE : H-P-1-ASPI-SP-0030

DATE : 07-Oct-2004

ISSUE : 5.0

PAGE : 41/89

Trapped Electrons flux on Transfert orbit (0.22 day) is calculated using the AE8 NASA GSFC model [RD-12]. Trapped Electrons fluxes are given in Figure 3-16 and Table 3.4-3.

# \*

## 3.4.4.2.1.2 Trapped Protons

# Reference **ENVM-390**

[P:SCI-PT-RS-05991 - Ch.5#5.5.5.3-SENV-111 H/P

Trapped Protons flux on Transfert orbit (0.22 day) is calculated using the AP8 NASA GSFC model [RD-12]. Trapped Protons flux is given in Figure 3-18 and Table 3.4-4.

# \*

## 3.4.4.2.1.3 Solar Protons

# Reference **ENVM-400**

[P:SCI-PT-RS-05991 - Ch.5#5.5.5.3-SENV-111 H/P

The mission Solar Protons fluence is calculated using the JPL Feynman Model considering a BOM in 2007 and a 4 years mission (0.5 years in Solar Max) combined with a prediction Confidence Level of 95% [RD-12]. Solar Protons fluence is given in Figure 3-20 and Table 3.4-5.

# \*

# Reference **ENVM-410**

[P:SCI-PT-RS-05991 - Ch.5#5.5.5.3-SENV-111 H/P

The Solar Protons Peak Flux (October 89 worst 5 minutes) to be considered for SEP rates calculations is given in Figure 3-22 and Table 3.4-6.

# \*

## 3.4.4.2.1.4 Cosmic Rays

# Reference **ENVM-420**

[P:SCI-PT-RS-05991 - Ch.5#5.5.5.3-SENV-111 H/P

Predictions of cosmic ray fluxes on orbit are obtained using the Cosmic Ray Effects on Micro Electronics (CREME96) suite of programs (from Naval Research Laboratory). Qualitatively, solar cycle variations have opposite effects on solar and galactic cosmic rays populations. To calculate worst case SEP rates, the cosmic rays environment will be calculated in terms of integral Linear Energy Transfer (LET) spectrum.

- Ion species :  $1 \leq Z \leq 92$
- Environment Model : Solar Quiet (no "flare") Conditions / Solar Minimum (Cosmic-Ray Maximum)
- Spacecraft Location : Near-Earth Interplanetary/Geosynchronous Orbit
- Shielding : 1 g/cm<sup>2</sup>

LET flux is given in Figure 3-24 and Table 3.4-7.

# \*

# ENVIRONMENT AND TESTS REQUIREMENTS (EVTR)

REFERENCE : H-P-1-ASPI-SP-0030

DATE : 07-Oct-2004

ISSUE : 5.0

PAGE : 42/89

## 3.4.4.2.2 Space Radiation Effects

If the Sub-Contractor don't use advanced particle/matter interaction simulation tools, the following 'between in' curves shall be used, instead of using directly particle fluxes and fluences as an input.

### 3.4.4.2.2.1 Dose depth curve

# Reference **ENVM-430**

[P:SCI-PT-RS-05991 - Ch.5#5.5.5.3-SENV-111 H/P

The particle fluxes specified in the previous sections are converted into Dose Depth Curve [RD-12], using SHIELDOSE software [RD-13]. This curve is calculated for an Aluminum Solid Sphere Shielding, with a Silicon Detector located in the center of the sphere. It shall be used to perform Ray Tracing Analysis to calculate Deposited Dose.

The mission Dose Depth Curve takes into account particle fluxes. This curve is given in Table 3.4-8 and Figure 3-26.

# \*

### 3.4.4.2.2.2 Single Event Phenomena

# Reference **ENVM-440**

[P:SCI-PT-RS-05991 - Ch.5#5.5.5.3-SENV-111 H/P

**Heavy Ions Induced SEU** : For Single Event Upset calculations, the SEU rate, normalized to a device cross section of 1 cm<sup>2</sup>, is calculated for various LET threshold. This SEU Rate versus LET<sub>th</sub> curve is given in Figure 3-28 and Table 3.4-9.

This curve shall be convoluted with the experimental Device Cross Sections versus LET curve, in order to get the Galactic Cosmic Rays SEU rate for the device.

# \*

# Reference **ENVM-450**

[P:SCI-PT-RS-05991 - Ch.5#5.5.5.3-SENV-111 H/P

**Protons Induced SEU** : : For Single Event Upset calculations, the SEU rate, normalized to a device cross section of 10<sup>-8</sup> cm<sup>2</sup>, is calculated for various LET threshold. This SEU Rate versus LET<sub>th</sub> curve is given in Table 3.4-10 and Figure 3-30.

# \*

# Reference **ENVM-460**

[P:SCI-PT-RS-05991 - Ch.5#5.5.5.3-SENV-111 H/P

For other effects (Latchup, Burnout, Gate Rupture, Hard Error, Transient, .....), the particle fluxes and fluences shall be directly used.

# \*

### 3.4.4.2.2.3 Displacement Damage

Both protons and electrons can induce displacement damage in semiconductor devices. The part of deposited energy involved in displacement defects creation is called NonIonizing Energy Loss (NIEL). The particles fluxes spectra are converted into a fluence of monoenergetic particles producing the same amount of defects (10 MeV protons).

# Reference **ENVM-470**

---

[P:SCI-PT-RS-05991 - Ch.5#5.5.5.3-SENV-111 H/P

The Displacement Damage Equivalent Fluence (10 MeV protons) is calculated using the NOVICE code [RD-14]. This curve is calculated for an Aluminum Solid Sphere Shielding. The mission Displacement Damage Equivalent Fluence Depth Curves are given in Figure 3-32 and Table 3.4-11 for Silicon and GaAs detectors.

---

# \*

### 3.4.4.2.2.4 SOLAR CELLS DEGRADATION EQUIVALENT FLUENCE

# Reference **ENVM-480**

---

[P:SCI-PT-RS-05991 - Ch.5#5.5.5.3-SENV-111 H/P

The Solar Cells degradation equivalent fluences of 1 MeV electrons as a function of cover glass thickness are calculated with the EQFRUX code (JPL) for the mission (5 years) [RD-12]. Infinite cell back shielding is assumed and a 10 MeV proton to 1 MeV electron equivalence ration of 3000 is used for maximum power degradation.

The results are provided in :

- Figure 3-34 and Table 3.4-12 for Pmax-Voc in Silicon
  - Figure 3-36 and Table 3.4-13 for Isc in Silicon
  - Figure 3-38 and Table 3.4-14 for Voc in GaAs
  - Figure 3-40 and Table 3.4-15 for Pmax in GaAs
  - Figure 3-42 and Table 3.4-16 for Isc in GaAs
- 

# \*

### 3.4.4.2.3 Figures and tables

### Trajectory-average electrons spectrum

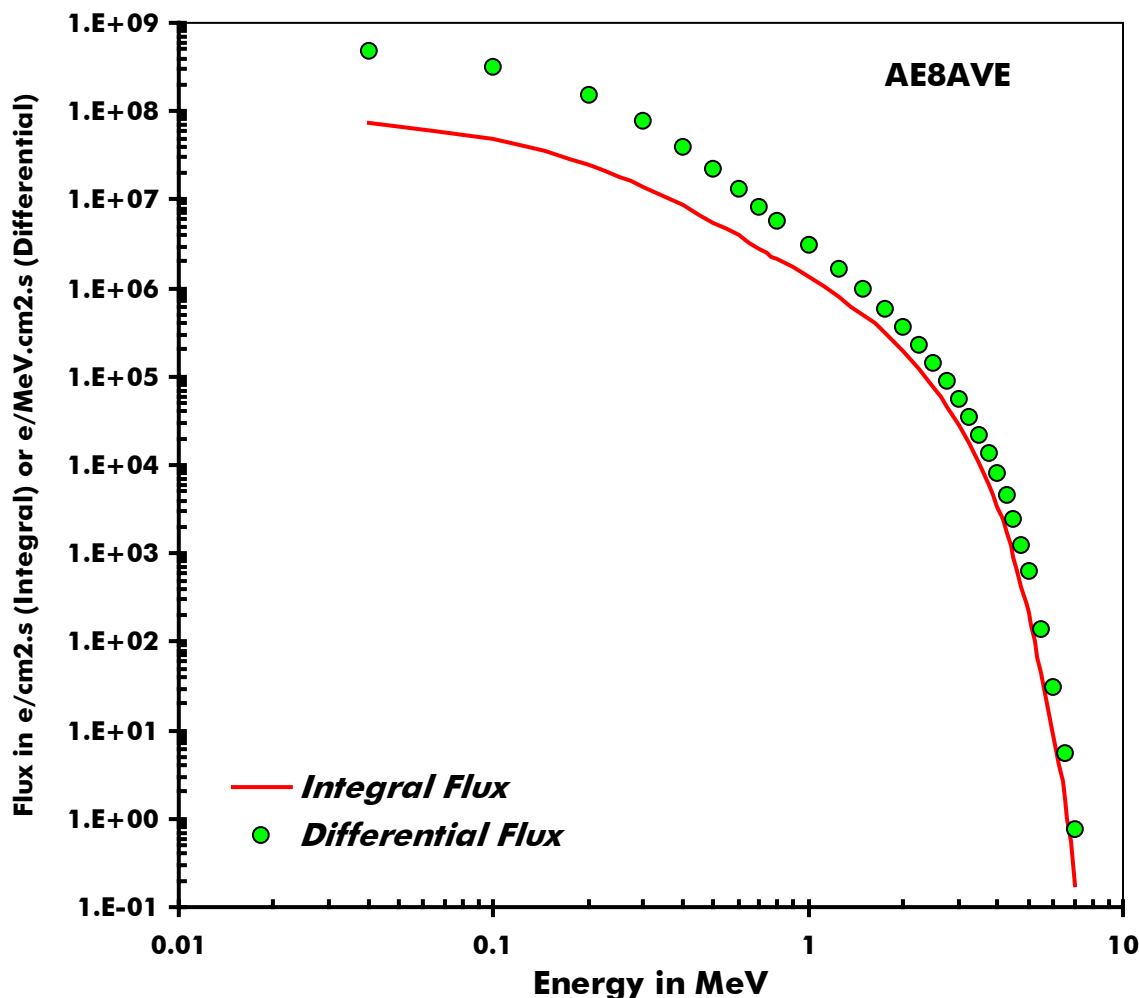
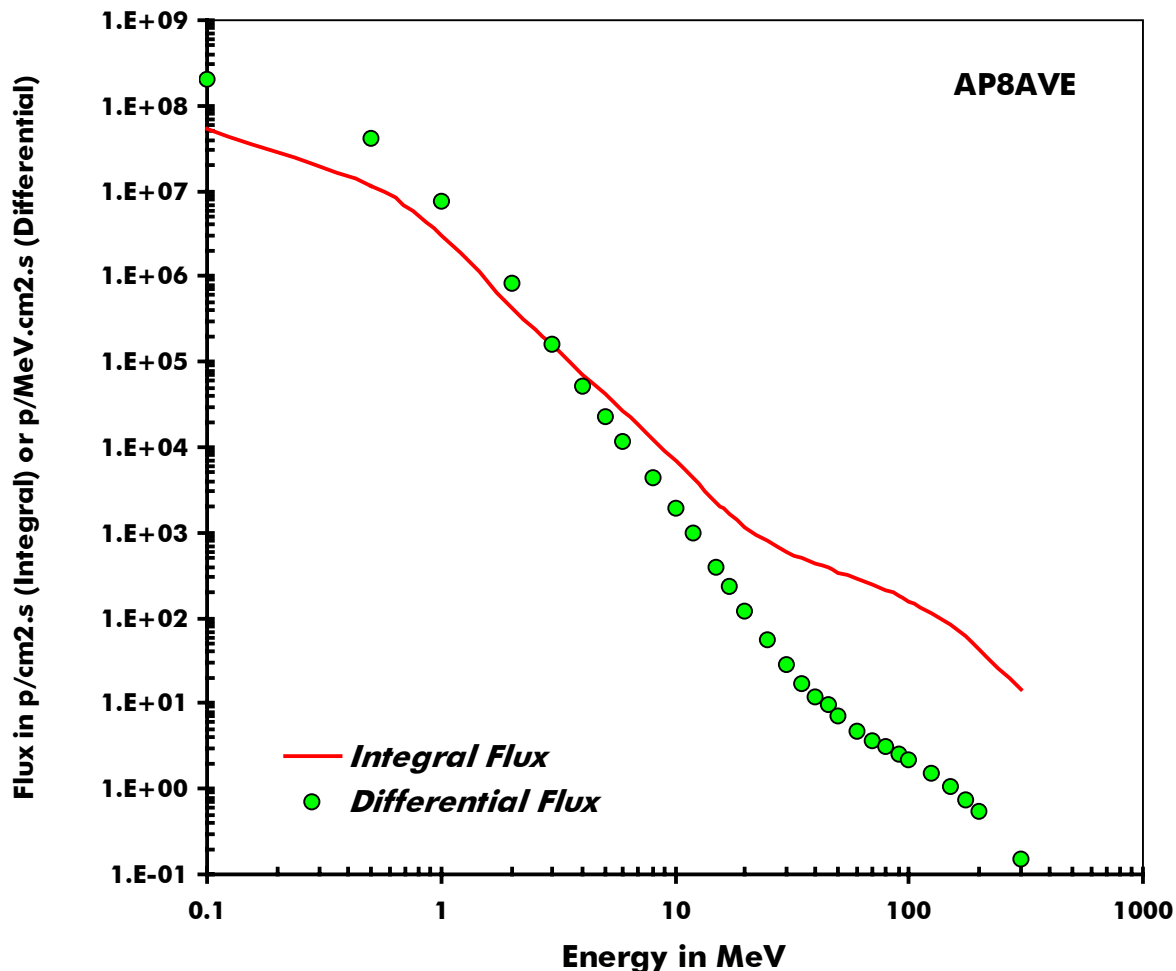

Figure 3-16: GTO Trapped Electrons Flux

Energy MeV	Int. Flux e/cm <sup>2</sup> .sec	Diff. Flux e/MeV.cm <sup>2</sup> .s	Energy MeV	Int. Flux e/cm <sup>2</sup> .sec	Diff. Flux e/MeV.cm <sup>2</sup> .s	Energy MeV	Int. Flux e/cm <sup>2</sup> .sec	Diff. Flux e/MeV.cm <sup>2</sup> .s
0.04	7.31E+07	4.92E+08	1.25	8.06E+05	1.65E+06	3.75	5.90E+03	1.36E+04
0.10	4.88E+07	3.25E+08	1.50	4.87E+05	9.61E+05	4.00	3.32E+03	7.97E+03
0.20	2.47E+07	1.55E+08	1.75	3.04E+05	5.77E+05	4.25	1.74E+03	4.55E+03
0.30	1.38E+07	7.61E+07	2.00	1.90E+05	3.56E+05	4.50	9.21E+02	2.48E+03
0.40	8.56E+06	3.97E+07	2.25	1.19E+05	2.23E+05	4.75	4.24E+02	1.26E+03
0.50	5.48E+06	2.22E+07	2.50	7.54E+04	1.42E+05	5.00	2.10E+02	6.21E+02
0.60	3.90E+06	1.33E+07	2.75	4.63E+04	8.96E+04	5.50	4.44E+01	1.39E+02
0.70	2.83E+06	8.49E+06	3.00	2.86E+04	5.61E+04	6.00	9.00E+00	3.04E+01
0.80	2.14E+06	5.64E+06	3.25	1.73E+04	3.53E+04	6.50	1.63E+00	5.58E+00
1.00	1.35E+06	3.03E+06	3.50	1.05E+04	2.23E+04	7.00	1.74E-01	7.53E-01

**Table 3.4-3: GTO Trapped Electrons Flux**

**Trajectory-average protons spectrum**

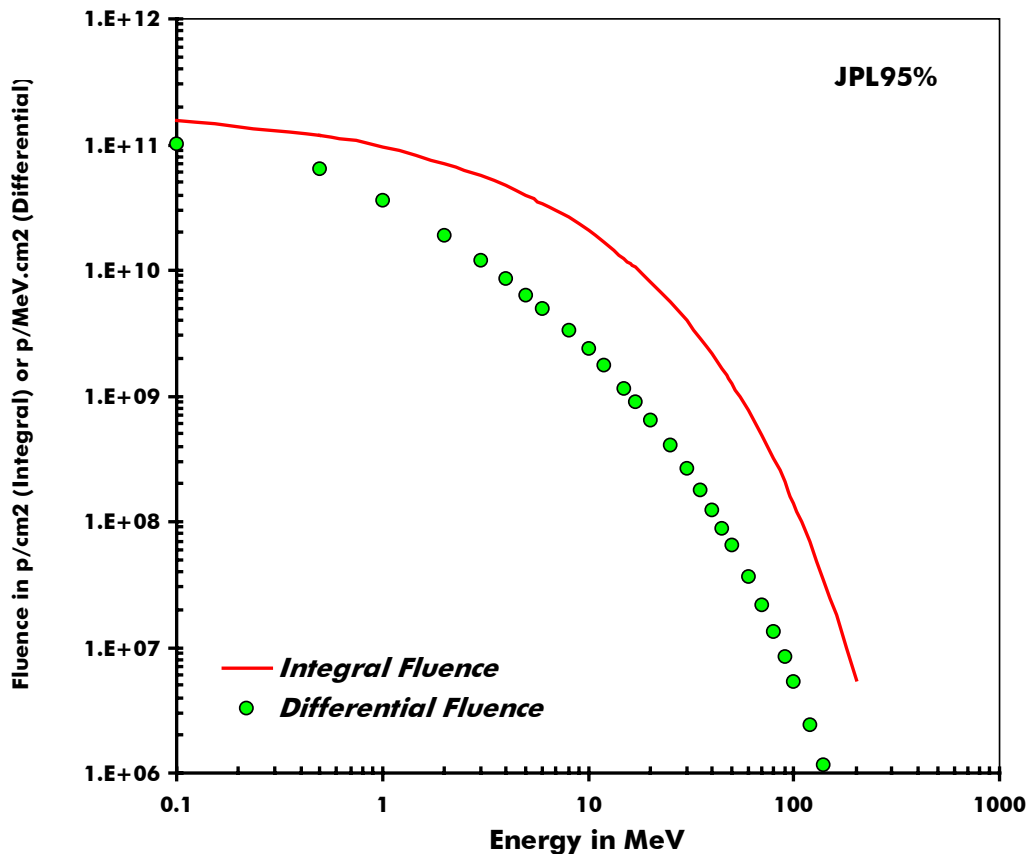

**Figure 3-18: GTO Trapped Protons Flux**

Energy MeV	Int. Flux p/cm2.s	Diff. Flux p/MeV.cm2.s	Energy MeV	Int. Flux p/cm2.s	Diff. Flux p/MeV.cm2.s	Energy MeV	Int. Flux p/cm2.s	Diff. Flux p/MeV.cm2.s
0.1	5.44E+07	2.07E+08	12.0	4.30E+03	1.01E+03	60.0	2.86E+02	4.82E+00
0.5	1.14E+07	4.08E+07	15.0	2.22E+03	4.02E+02	70.0	2.45E+02	3.72E+00
1.0	2.99E+06	7.51E+06	17.0	1.68E+03	2.35E+02	80.0	2.11E+02	3.09E+00
2.0	4.31E+05	8.15E+05	20.0	1.14E+03	1.19E+02	90.0	1.83E+02	2.58E+00
3.0	1.58E+05	1.64E+05	25.0	7.98E+02	5.46E+01	100.0	1.59E+02	2.17E+00
4.0	7.17E+04	5.28E+04	30.0	5.82E+02	2.83E+01	125.0	1.15E+02	1.50E+00
5.0	4.22E+04	2.25E+04	35.0	5.02E+02	1.69E+01	150.0	8.30E+01	1.07E+00
6.0	2.61E+04	1.14E+04	40.0	4.37E+02	1.20E+01	175.0	6.03E+01	7.61E-01
8.0	1.25E+04	4.31E+03	45.0	3.83E+02	9.48E+00	200.0	4.40E+01	5.36E-01
10.0	6.85E+03	1.94E+03	50.0	3.38E+02	7.22E+00	300.0	1.48E+01	1.53E-01

**Table 3.4-4: GTO Trapped Protons Flux**

**BOM2007 - 4y Solar Protons Fluence**



**Figure 3-20: Solar Protons Fluence for the 4 years mission BOM 2007**

Energy MeV	Int. Fluence p/cm2	Diff. Fluence p/MeV.cm2	Energy MeV	Int. Fluence p/cm2	Diff. Fluence p/MeV.cm2
1.00E-01	1.54E+11	1.02E+11	3.00E+01	3.98E+09	2.65E+08
5.00E-01	1.17E+11	6.42E+10	3.50E+01	2.90E+09	1.79E+08
1.00E+00	9.52E+10	3.60E+10	4.00E+01	2.16E+09	1.25E+08
2.00E+00	7.11E+10	1.90E+10	4.50E+01	1.63E+09	8.91E+07
3.00E+00	5.69E+10	1.21E+10	5.00E+01	1.26E+09	6.47E+07
4.00E+00	4.71E+10	8.56E+09	6.00E+01	7.65E+08	3.67E+07
5.00E+00	3.99E+10	6.38E+09	7.00E+01	4.84E+08	2.17E+07
6.00E+00	3.43E+10	4.94E+09	8.00E+01	3.15E+08	1.33E+07
8.00E+00	2.63E+10	3.33E+09	9.00E+01	2.10E+08	8.37E+06
1.00E+01	2.07E+10	2.36E+09	1.00E+02	1.42E+08	5.39E+06
1.20E+01	1.67E+10	1.73E+09	1.20E+02	6.88E+07	2.44E+06
1.50E+01	1.25E+10	1.16E+09	1.40E+02	3.49E+07	1.16E+06
1.70E+01	1.05E+10	9.07E+08	1.60E+02	1.84E+07	5.81E+05
2.00E+01	8.18E+09	6.49E+08	1.80E+02	9.99E+06	3.03E+05
2.50E+01	5.61E+09	4.06E+08	2.00E+02	5.57E+06	1.63E+05

**Table 3.4-5: Solar Protons Fluence for the 4 years mission BOM 2007**

**Solar Protons Peak Flux**

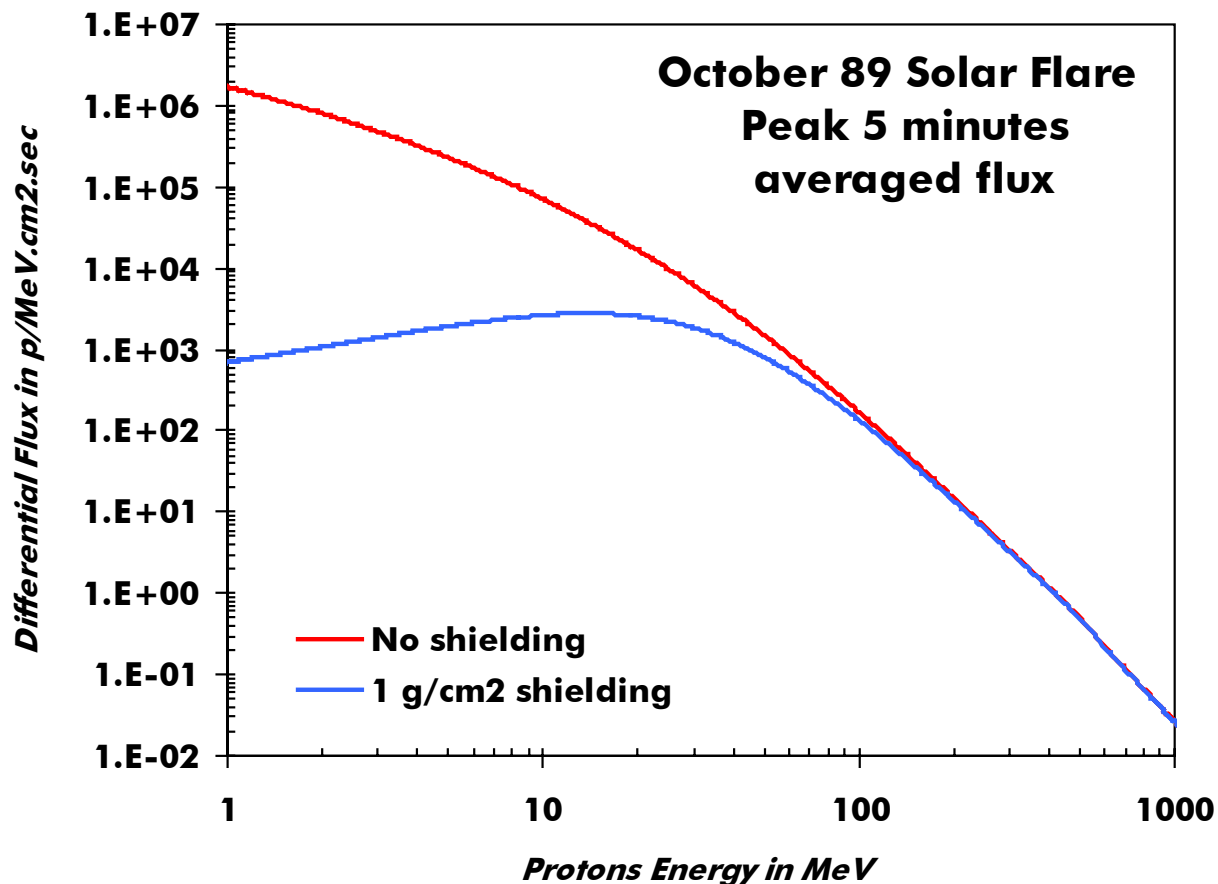

Figure 3-22: Solar Protons Peak Fluxes

	No Shielding	1g/cm2 shd		No Shielding	1g/cm2 shd
Energy MeV	Differential Flux p/MeV.cm2.sec	Differential Flux p/MeV.cm2.sec	Energy MeV	Differential Flux p/MeV.cm2.sec	Differential Flux p/MeV.cm2.sec
1.00E+00	1.70E+06	6.95E+02	5.05E+01	1.46E+03	7.88E+02
2.00E+00	8.00E+05	1.07E+03	6.04E+01	8.55E+02	5.28E+02
3.02E+00	4.74E+05	1.40E+03	7.03E+01	5.33E+02	3.62E+02
3.98E+00	3.23E+05	1.67E+03	8.07E+01	3.43E+02	2.50E+02
5.04E+00	2.28E+05	1.93E+03	9.02E+01	2.39E+02	1.83E+02
7.02E+00	1.33E+05	2.30E+03	1.01E+02	1.65E+02	1.32E+02
1.00E+01	6.99E+04	2.65E+03	1.20E+02	8.97E+01	7.54E+01
1.20E+01	4.94E+04	2.76E+03	1.50E+02	4.14E+01	3.65E+01
1.50E+01	3.13E+04	2.77E+03	2.01E+02	1.46E+01	1.35E+01
1.79E+01	2.12E+04	2.67E+03	3.00E+02	3.41E+00	3.26E+00
2.00E+01	1.65E+04	2.56E+03	5.06E+02	4.78E-01	4.65E-01
3.03E+01	5.99E+03	1.82E+03	8.09E+02	6.31E-02	6.19E-02
4.05E+01	2.75E+03	1.20E+03	1.01E+03	2.53E-02	2.49E-02

Table 3.4-6: Solar Protons Peak Fluxes

**GALACTIC COSMIC RAYS**

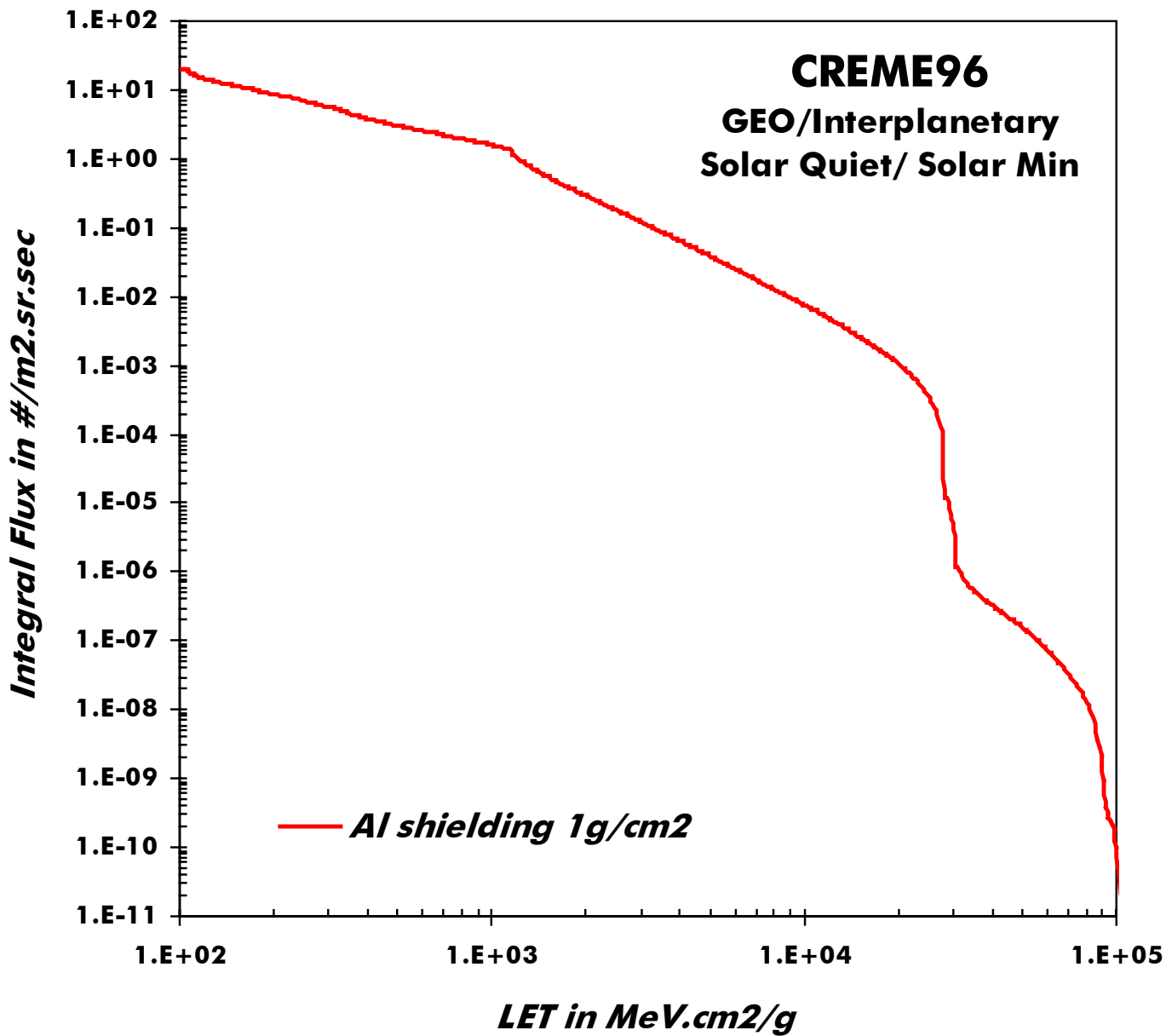

Figure 3-24: Galactic Cosmic Rays LET spectrum



# ENVIRONMENT AND TESTS REQUIREMENTS (EVTR)

REFERENCE : H-P-1-ASPI-SP-0030

DATE : 07-Oct-2004

ISSUE : 5.0

PAGE : 49/89

LET MeV-cm2/g	Integral Flux #/m2.sr.sec	LET MeV-cm2/g	Integral Flux #/m2.sr.sec	LET MeV-cm2/g	Integral Flux #/m2.sr.sec	LET MeV-cm2/g	Integral Flux #/m2.sr.sec	LET MeV-cm2/g	Integral Flux #/m2.sr.sec
1.01E+02	1.97E+01	4.06E+02	3.77E+00	1.63E+03	4.54E-01	6.57E+03	2.04E-02	2.64E+04	2.17E-04
1.03E+02	1.95E+01	4.16E+02	3.68E+00	1.67E+03	4.31E-01	6.72E+03	1.93E-02	2.70E+04	1.57E-04
1.06E+02	1.93E+01	4.26E+02	3.60E+00	1.71E+03	4.09E-01	6.88E+03	1.83E-02	2.77E+04	9.81E-05
1.08E+02	1.76E+01	4.36E+02	3.49E+00	1.75E+03	3.89E-01	7.04E+03	1.73E-02	2.83E+04	1.28E-05
1.11E+02	1.66E+01	4.46E+02	3.39E+00	1.79E+03	3.70E-01	7.21E+03	1.63E-02	2.90E+04	1.00E-05
1.13E+02	1.59E+01	4.56E+02	3.30E+00	1.83E+03	3.52E-01	7.38E+03	1.54E-02	2.97E+04	6.96E-06
1.16E+02	1.53E+01	4.67E+02	3.23E+00	1.88E+03	3.34E-01	7.55E+03	1.46E-02	3.04E+04	2.03E-06
1.19E+02	1.48E+01	4.78E+02	3.16E+00	1.92E+03	3.18E-01	7.73E+03	1.38E-02	3.11E+04	1.14E-06
1.22E+02	1.43E+01	4.89E+02	3.08E+00	1.97E+03	3.02E-01	7.91E+03	1.31E-02	3.18E+04	9.43E-07
1.24E+02	1.39E+01	5.01E+02	3.01E+00	2.01E+03	2.87E-01	8.09E+03	1.25E-02	3.26E+04	7.71E-07
1.27E+02	1.35E+01	5.12E+02	2.95E+00	2.06E+03	2.73E-01	8.28E+03	1.18E-02	3.33E+04	6.70E-07
1.30E+02	1.32E+01	5.24E+02	2.89E+00	2.11E+03	2.60E-01	8.48E+03	1.12E-02	3.41E+04	6.03E-07
1.33E+02	1.29E+01	5.37E+02	2.84E+00	2.16E+03	2.47E-01	8.68E+03	1.06E-02	3.49E+04	5.38E-07
1.37E+02	1.25E+01	5.49E+02	2.77E+00	2.21E+03	2.35E-01	8.88E+03	1.01E-02	3.57E+04	4.93E-07
1.40E+02	1.23E+01	5.62E+02	2.70E+00	2.26E+03	2.24E-01	9.09E+03	9.54E-03	3.66E+04	4.53E-07
1.43E+02	1.20E+01	5.75E+02	2.65E+00	2.31E+03	2.13E-01	9.30E+03	9.02E-03	3.74E+04	4.14E-07
1.46E+02	1.17E+01	5.89E+02	2.60E+00	2.37E+03	2.02E-01	9.52E+03	8.53E-03	3.83E+04	3.83E-07
1.50E+02	1.15E+01	6.03E+02	2.55E+00	2.42E+03	1.92E-01	9.75E+03	8.07E-03	3.92E+04	3.54E-07
1.53E+02	1.13E+01	6.17E+02	2.49E+00	2.48E+03	1.83E-01	9.97E+03	7.63E-03	4.01E+04	3.26E-07
1.57E+02	1.11E+01	6.31E+02	2.44E+00	2.54E+03	1.74E-01	1.02E+04	7.23E-03	4.10E+04	3.01E-07
1.61E+02	1.09E+01	6.46E+02	2.39E+00	2.60E+03	1.65E-01	1.04E+04	6.82E-03	4.20E+04	2.77E-07
1.64E+02	1.07E+01	6.61E+02	2.35E+00	2.66E+03	1.57E-01	1.07E+04	6.45E-03	4.30E+04	2.57E-07
1.68E+02	1.03E+01	6.77E+02	2.30E+00	2.72E+03	1.50E-01	1.09E+04	6.08E-03	4.40E+04	2.37E-07
1.72E+02	1.00E+01	6.93E+02	2.22E+00	2.79E+03	1.42E-01	1.12E+04	5.73E-03	4.50E+04	2.20E-07
1.76E+02	9.75E+00	7.09E+02	2.17E+00	2.85E+03	1.35E-01	1.15E+04	5.41E-03	4.61E+04	2.04E-07
1.80E+02	9.52E+00	7.26E+02	2.13E+00	2.92E+03	1.28E-01	1.17E+04	5.07E-03	4.72E+04	1.89E-07
1.85E+02	9.31E+00	7.43E+02	2.08E+00	2.99E+03	1.22E-01	1.20E+04	4.74E-03	4.83E+04	1.75E-07
1.89E+02	9.12E+00	7.60E+02	2.04E+00	3.06E+03	1.16E-01	1.23E+04	4.48E-03	4.94E+04	1.61E-07
1.93E+02	8.94E+00	7.78E+02	2.00E+00	3.13E+03	1.10E-01	1.26E+04	4.21E-03	5.06E+04	1.49E-07
1.98E+02	8.78E+00	7.96E+02	1.96E+00	3.20E+03	1.05E-01	1.29E+04	3.96E-03	5.18E+04	1.36E-07
2.03E+02	8.61E+00	8.15E+02	1.93E+00	3.28E+03	9.98E-02	1.32E+04	3.71E-03	5.30E+04	1.25E-07
2.07E+02	8.42E+00	8.34E+02	1.87E+00	3.35E+03	9.47E-02	1.35E+04	3.49E-03	5.42E+04	1.14E-07
2.12E+02	8.25E+00	8.53E+02	1.83E+00	3.43E+03	9.01E-02	1.38E+04	3.27E-03	5.55E+04	1.04E-07
2.17E+02	8.10E+00	8.73E+02	1.80E+00	3.51E+03	8.55E-02	1.41E+04	3.06E-03	5.68E+04	9.43E-08
2.22E+02	7.97E+00	8.94E+02	1.76E+00	3.59E+03	8.13E-02	1.45E+04	2.85E-03	5.81E+04	8.48E-08
2.28E+02	7.84E+00	9.15E+02	1.72E+00	3.68E+03	7.71E-02	1.48E+04	2.68E-03	5.95E+04	7.68E-08
2.33E+02	7.72E+00	9.36E+02	1.69E+00	3.77E+03	7.33E-02	1.51E+04	2.52E-03	6.09E+04	6.89E-08
2.38E+02	7.60E+00	9.58E+02	1.66E+00	3.85E+03	6.95E-02	1.55E+04	2.36E-03	6.23E+04	6.08E-08
2.44E+02	7.21E+00	9.81E+02	1.62E+00	3.94E+03	6.61E-02	1.59E+04	2.21E-03	6.38E+04	5.46E-08
2.50E+02	6.92E+00	1.00E+03	1.57E+00	4.04E+03	6.27E-02	1.62E+04	2.07E-03	6.53E+04	4.90E-08
2.55E+02	6.70E+00	1.03E+03	1.54E+00	4.13E+03	5.95E-02	1.66E+04	1.93E-03	6.68E+04	4.37E-08
2.61E+02	6.52E+00	1.05E+03	1.51E+00	4.23E+03	5.66E-02	1.70E+04	1.81E-03	6.84E+04	3.89E-08
2.68E+02	6.35E+00	1.08E+03	1.46E+00	4.33E+03	5.36E-02	1.74E+04	1.69E-03	7.00E+04	3.41E-08
2.74E+02	6.20E+00	1.10E+03	1.43E+00	4.43E+03	5.09E-02	1.78E+04	1.57E-03	7.16E+04	2.98E-08
2.80E+02	6.07E+00	1.13E+03	1.40E+00	4.53E+03	4.82E-02	1.82E+04	1.46E-03	7.33E+04	2.58E-08
2.87E+02	5.89E+00	1.15E+03	1.27E+00	4.64E+03	4.58E-02	1.87E+04	1.36E-03	7.50E+04	2.21E-08
2.94E+02	5.74E+00	1.18E+03	1.11E+00	4.75E+03	4.34E-02	1.91E+04	1.26E-03	7.68E+04	1.88E-08
3.01E+02	5.61E+00	1.21E+03	1.01E+00	4.86E+03	4.12E-02	1.95E+04	1.16E-03	7.86E+04	1.57E-08
3.08E+02	5.49E+00	1.24E+03	9.38E-01	4.97E+03	3.90E-02	2.00E+04	1.07E-03	8.04E+04	1.29E-08
3.15E+02	5.38E+00	1.27E+03	8.74E-01	5.09E+03	3.69E-02	2.05E+04	9.78E-04	8.23E+04	1.02E-08
3.22E+02	5.28E+00	1.30E+03	8.19E-01	5.21E+03	3.50E-02	2.10E+04	8.91E-04	8.42E+04	7.53E-09
3.30E+02	5.07E+00	1.33E+03	7.69E-01	5.33E+03	3.32E-02	2.14E+04	8.04E-04	8.62E+04	4.84E-09
3.37E+02	4.79E+00	1.36E+03	7.16E-01	5.46E+03	3.15E-02	2.19E+04	7.32E-04	8.82E+04	2.80E-09
3.45E+02	4.60E+00	1.39E+03	6.71E-01	5.59E+03	2.98E-02	2.25E+04	6.59E-04	9.03E+04	1.57E-09
3.54E+02	4.45E+00	1.42E+03	6.32E-01	5.72E+03	2.83E-02	2.30E+04	5.90E-04	9.24E+04	3.69E-10
3.62E+02	4.31E+00	1.45E+03	5.96E-01	5.85E+03	2.68E-02	2.35E+04	5.17E-04	9.46E+04	2.76E-10
3.70E+02	4.19E+00	1.49E+03	5.63E-01	5.99E+03	2.54E-02	2.41E+04	4.56E-04	9.68E+04	2.18E-10
3.79E+02	4.07E+00	1.52E+03	5.33E-01	6.13E+03	2.40E-02	2.46E+04	3.92E-04	9.91E+04	1.50E-10
3.88E+02	3.96E+00	1.56E+03	5.05E-01	6.27E+03	2.28E-02	2.52E+04	3.34E-04	1.01E+05	4.59E-11

Table 3.4-7: Galactic Cosmic Rays LET spectrum

## HERSCHEL\_PLANCK Dose Depth Curve

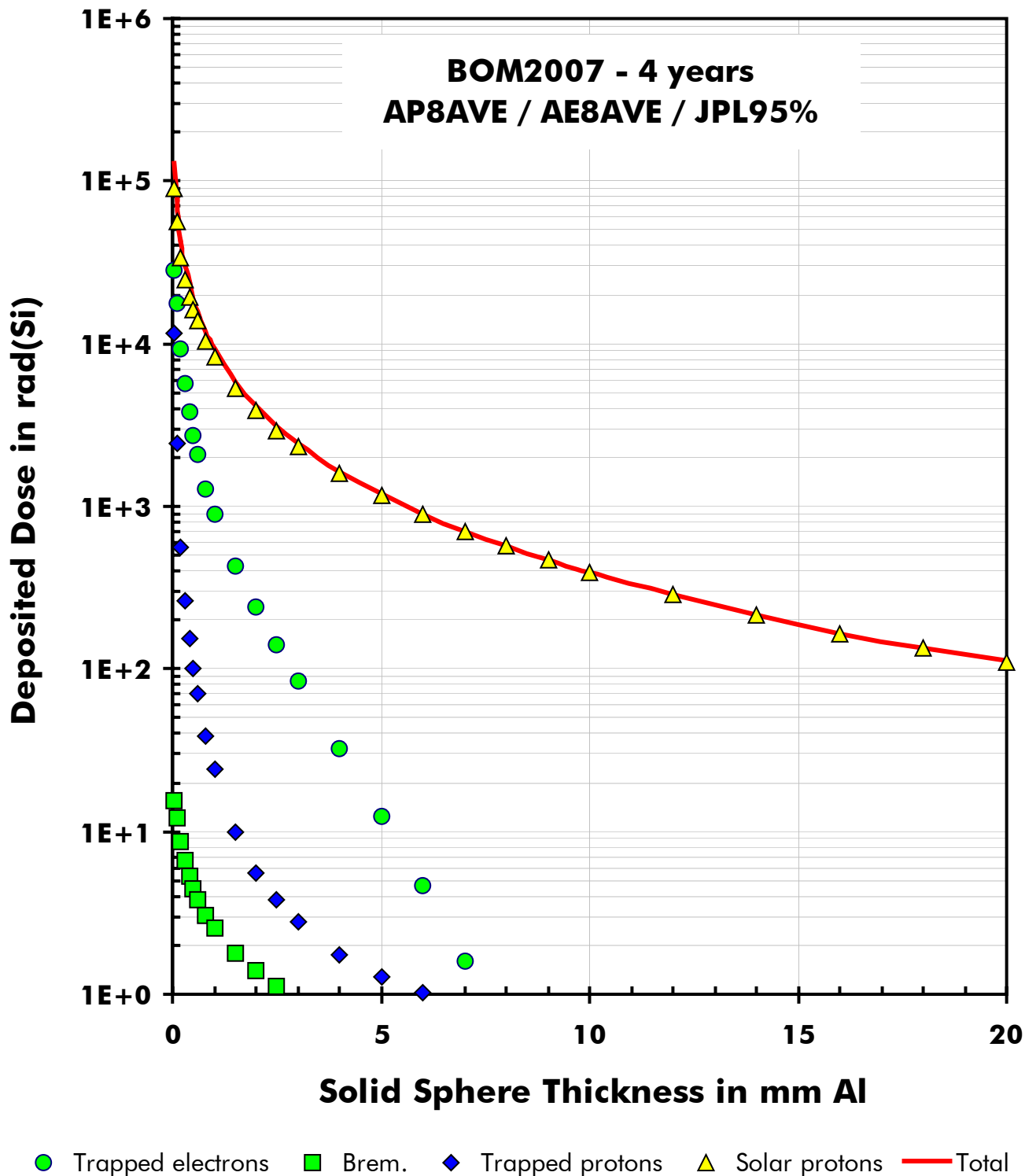

Figure 3-26: Mission Dose Depth Curve

# ENVIRONMENT AND TESTS REQUIREMENTS (EVTR)

REFERENCE : H-P-1-ASPI-SP-0030

DATE : 07-Oct-2004

ISSUE : 5.0

PAGE : 51/89

			Detector : Si				
Z mils	Z mm	Z g/cm2	Electrons rad	Brem. rad	TR. Protons rad	Sol. Protons rad	TOTAL rad
1.97E+00	5.00E-02	1.40E-02	28420	16	11580	89210	1.29E+05
3.94E+00	1.00E-01	2.70E-02	17790	12	2421	56370	7.66E+04
7.87E+00	2.00E-01	5.40E-02	9185	9	564	33540	4.33E+04
1.18E+01	3.00E-01	8.10E-02	5651	7	263	24580	3.05E+04
1.57E+01	4.00E-01	1.08E-01	3815	5	155	19580	2.36E+04
1.97E+01	5.00E-01	1.35E-01	2742	4	101	16200	1.90E+04
2.36E+01	6.00E-01	1.62E-01	2064	4	70	13740	1.59E+04
3.15E+01	8.00E-01	2.16E-01	1291	3	39	10410	1.17E+04
3.94E+01	1.00E+00	2.70E-01	885	3	24	8312	9.22E+03
5.91E+01	1.50E+00	4.05E-01	431	2	10	5344	5.79E+03
7.87E+01	2.00E+00	5.40E-01	239	1	6	3905	4.15E+03
9.84E+01	2.50E+00	6.75E-01	140	1	4	2945	3.09E+03
1.18E+02	3.00E+00	8.10E-01	84	1	3	2343	2.43E+03
1.57E+02	4.00E+00	1.08E+00	32	1	2	1597	1.63E+03
1.97E+02	5.00E+00	1.35E+00	12	1	1	1169	1.18E+03
2.36E+02	6.00E+00	1.62E+00	5	1	1	893	8.99E+02
2.76E+02	7.00E+00	1.89E+00	2	0	1	702	7.05E+02
3.15E+02	8.00E+00	2.16E+00		0	1	574	5.75E+02
3.54E+02	9.00E+00	2.43E+00		0	1	465	4.66E+02
3.94E+02	1.00E+01	2.70E+00		0	1	389	3.90E+02
4.72E+02	1.20E+01	3.24E+00		0	0	287	2.88E+02
5.51E+02	1.40E+01	3.78E+00		0	0	215	2.16E+02
6.30E+02	1.60E+01	4.32E+00		0	0	166	1.66E+02
7.09E+02	1.80E+01	4.86E+00		0	0	134	1.34E+02
7.87E+02	2.00E+01	5.40E+00		0	0	111	1.12E+02

**Table 3.4-8: Mission Dose Depth Curve**

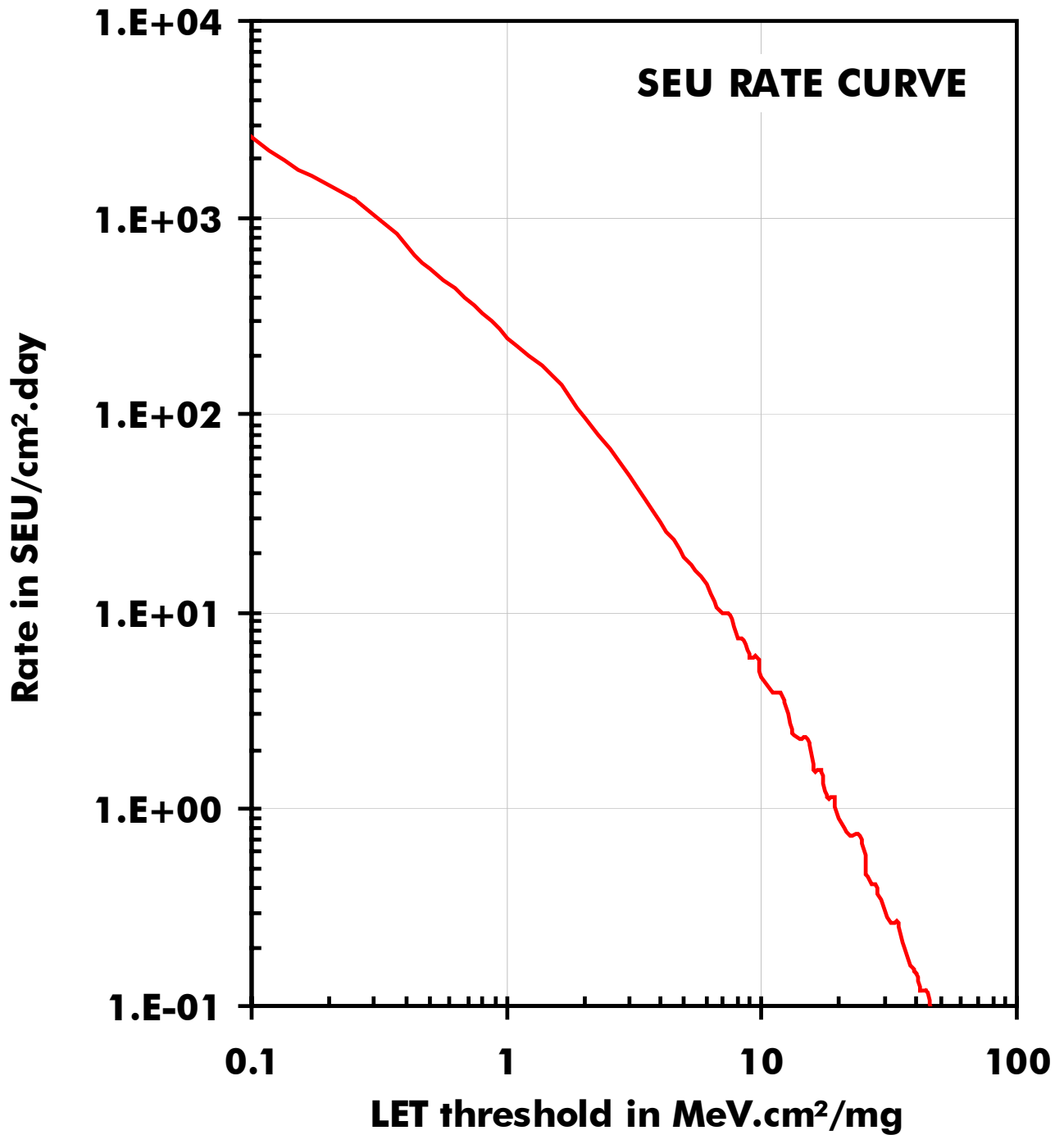

**Figure 3-28: Heavy Ions Induced SEU rate**

# ENVIRONMENT AND TESTS REQUIREMENTS (EVTR)

REFERENCE : H-P-1-ASPI-SP-0030

DATE : 07-Oct-2004

ISSUE : 5.0

PAGE : 53/89

LET	RATE	LET	RATE	LET	RATE
MeV.cm <sup>2</sup> /mg	seu/cm <sup>2</sup> .day	MeV.cm <sup>2</sup> /mg	seu/cm <sup>2</sup> .day	MeV.cm <sup>2</sup> /mg	seu/cm <sup>2</sup> .day
0.005	7.81E+04	16	1.57E+00	72	2.75E-02
0.01	3.51E+04	17	1.57E+00	74	2.40E-02
0.1	2.57E+03	18	1.17E+00	76	2.16E-02
0.25	1.27E+03	19	1.17E+00	78	2.16E-02
0.5	5.54E+02	20	9.10E-01	80	2.08E-02
0.75	3.67E+02	22	7.40E-01	82	1.80E-02
1	2.47E+02	24	7.40E-01	84	1.61E-02
1.5	1.59E+02	26	4.51E-01	86	1.47E-02
2	9.72E+01	28	3.95E-01	88	1.47E-02
2.5	6.76E+01	30	3.05E-01	90	1.44E-02
3	4.95E+01	32	2.68E-01	92	1.26E-02
3.5	3.77E+01	34	2.68E-01	94	1.13E-02
4	2.92E+01	36	1.94E-01	96	1.04E-02
4.5	2.33E+01	38	1.60E-01	98	1.04E-02
5	1.92E+01	40	1.48E-01	100	1.10E-02
5.5	1.63E+01	42	1.22E-01	102	9.41E-03
6	1.40E+01	44	1.22E-01	104	8.39E-03
6.5	1.13E+01	46	9.69E-02	106	7.63E-03
7	1.00E+01	48	8.31E-02	108	7.02E-03
7.5	9.69E+00	50	8.21E-02	110	7.02E-03
8	7.51E+00	52	6.79E-02	112	7.84E-03
8.5	7.16E+00	54	5.93E-02	114	6.67E-03
9	5.87E+00	56	5.93E-02	116	5.93E-03
9.5	5.87E+00	58	5.01E-02	118	5.39E-03
10	4.74E+00	60	4.39E-02	120	4.96E-03
11	3.98E+00	62	4.39E-02	130	4.03E-03
12	3.71E+00	64	3.90E-02	140	4.03E-03
13	2.56E+00	66	3.38E-02	150	2.24E-03
14	2.27E+00	68	3.02E-02	200	1.02E-03
15	2.27E+00	70	3.02E-02	250	4.74E-04

**Table 3.4-9: Heavy Ions Induced SEU rates**

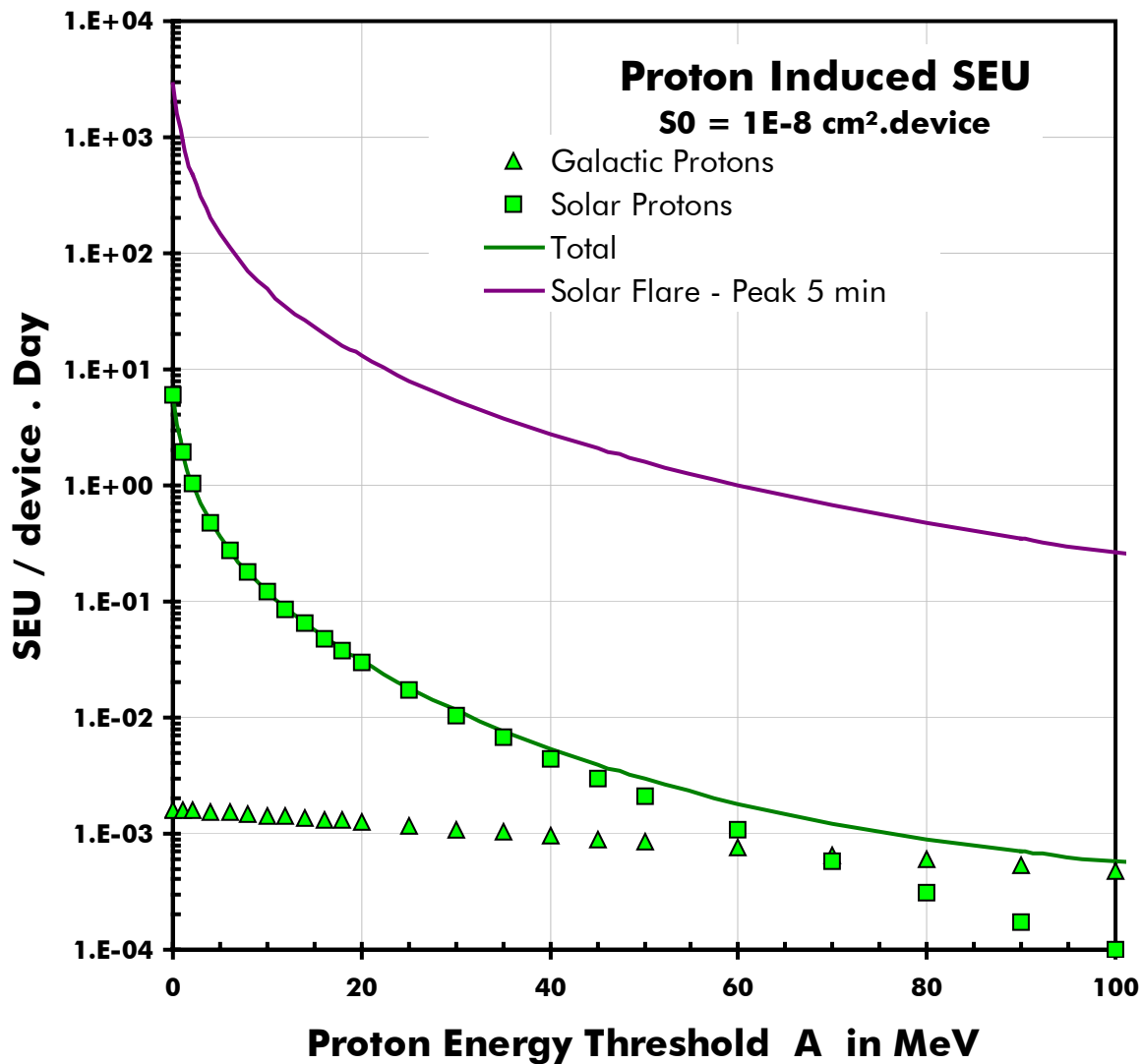

**Figure 3-30: Protons Induced SEU rates**

# ENVIRONMENT AND TESTS REQUIREMENTS (EVTR)

REFERENCE : H-P-1-ASPI-SP-0030

DATE : 07-Oct-2004

ISSUE : 5.0

PAGE : 55/89

<b>S<sub>0</sub> cm<sup>2</sup></b> <b>1.0E-08</b>	Galactic Protons	Solar Protons	Total	Solar Flare - Peak 5 min
	<b>Rate</b>	<b>Rate</b>	<b>Rate</b>	<b>Rate</b>
	seu/device.day	seu/device.day	seu/device.day	seu/device.day
<b>E</b> <b>Threshold</b> MeV				
0.1	1.58E-03	5.93E+00	5.93E+00	2.83E+03
1	1.58E-03	1.91E+00	1.91E+00	9.28E+02
2	1.57E-03	1.05E+00	1.05E+00	4.71E+02
4	1.55E-03	4.84E-01	4.86E-01	2.02E+02
6	1.52E-03	2.79E-01	2.81E-01	1.13E+02
8	1.48E-03	1.78E-01	1.80E-01	7.16E+01
10	1.45E-03	1.22E-01	1.23E-01	4.90E+01
12	1.41E-03	8.70E-02	8.84E-02	3.53E+01
14	1.37E-03	6.42E-02	6.55E-02	2.64E+01
16	1.34E-03	4.86E-02	4.99E-02	2.04E+01
18	1.30E-03	3.76E-02	3.89E-02	1.61E+01
20	1.26E-03	2.95E-02	3.08E-02	1.30E+01
25	1.18E-03	1.71E-02	1.83E-02	8.05E+00
30	1.10E-03	1.05E-02	1.16E-02	5.36E+00
35	1.03E-03	6.71E-03	7.74E-03	3.76E+00
40	9.62E-04	4.45E-03	5.41E-03	2.74E+00
45	9.02E-04	3.03E-03	3.93E-03	2.06E+00
50	8.46E-04	2.12E-03	2.96E-03	1.59E+00
60	7.47E-04	1.07E-03	1.82E-03	1.00E+00
70	6.63E-04	5.69E-04	1.23E-03	6.75E-01
80	5.91E-04	3.10E-04	9.02E-04	4.75E-01
90	5.29E-04	1.73E-04	7.02E-04	3.47E-01
100	4.75E-04	9.87E-05	5.74E-04	2.62E-01
200	1.82E-04	8.76E-22	1.82E-04	3.70E-02
400	3.23E-05	8.76E-22	3.23E-05	4.34E-03

**Table 3.4-10: Protons Induced SEU rates**

## HERSCHEL\_PLANCK DDEF DEPTH CURVE

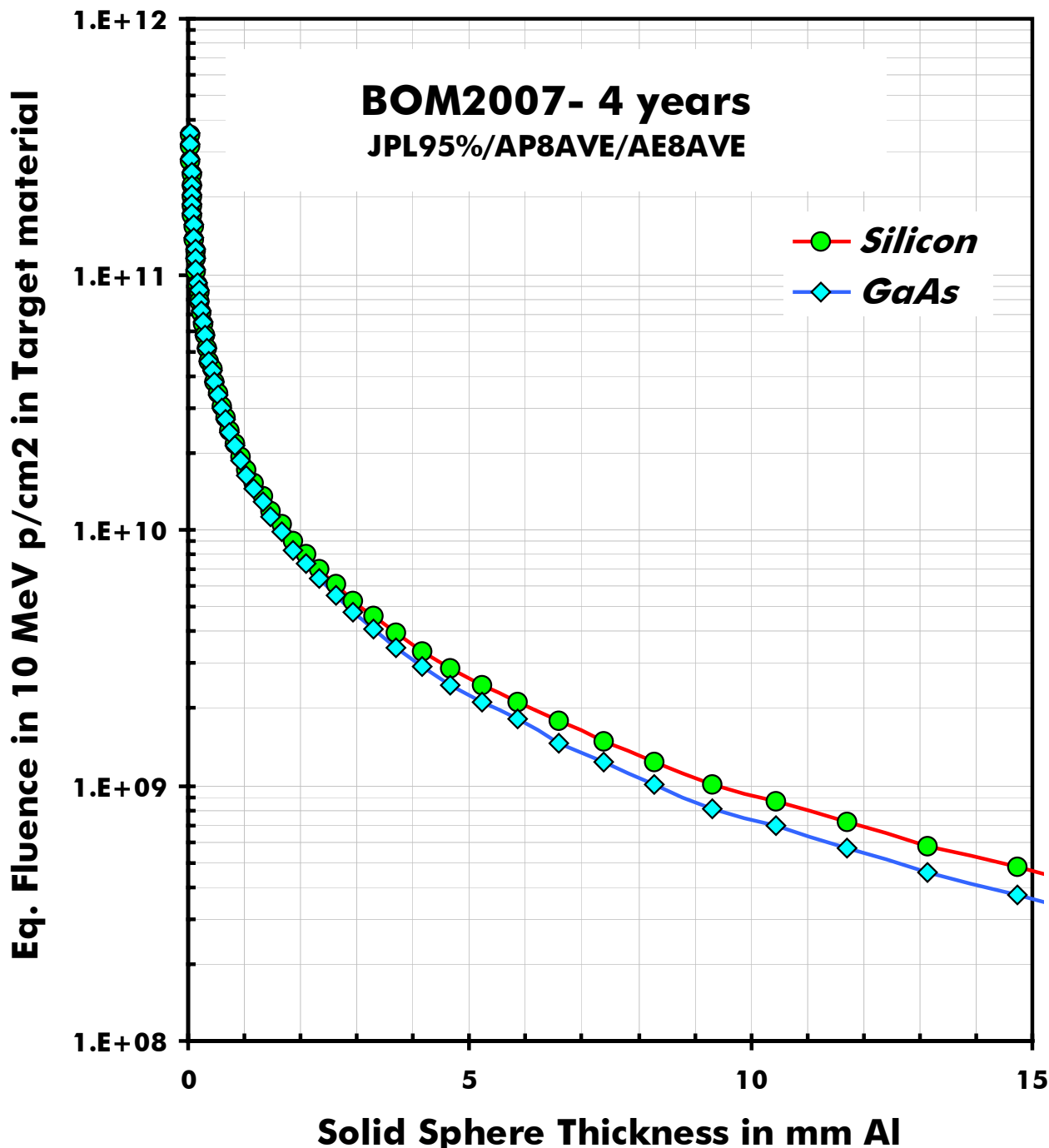

Figure 3-32: Mission DDEF Depth Curves for Si and GaAs detectors



# ENVIRONMENT AND TESTS REQUIREMENTS (EVTR)

REFERENCE : H-P-1-ASPI-SP-0030

DATE : 07-Oct-2004

ISSUE : 5.0

PAGE : 57/89

Al thick. mm	10MeV p/cm2 Silicon	10MeV p/cm2 GaAs	Al thick. mm	10MeV p/cm2 Silicon	10MeV p/cm2 GaAs
3.70E-02	3.51E+11	3.56E+11	1.31E+00	1.35E+10	1.28E+10
4.20E-02	3.17E+11	3.20E+11	1.47E+00	1.19E+10	1.12E+10
4.70E-02	2.80E+11	2.83E+11	1.65E+00	1.06E+10	9.90E+09
5.20E-02	2.45E+11	2.49E+11	1.86E+00	9.03E+09	8.37E+09
5.90E-02	2.21E+11	2.25E+11	2.08E+00	8.07E+09	7.44E+09
6.60E-02	2.01E+11	2.04E+11	2.34E+00	7.07E+09	6.46E+09
7.40E-02	1.85E+11	1.89E+11	2.62E+00	6.14E+09	5.57E+09
8.30E-02	1.71E+11	1.73E+11	2.94E+00	5.29E+09	4.74E+09
9.30E-02	1.54E+11	1.56E+11	3.30E+00	4.63E+09	4.12E+09
1.04E-01	1.37E+11	1.40E+11	3.70E+00	3.94E+09	3.47E+09
1.17E-01	1.24E+11	1.26E+11	4.16E+00	3.36E+09	2.91E+09
1.31E-01	1.14E+11	1.16E+11	4.66E+00	2.87E+09	2.47E+09
1.47E-01	1.02E+11	1.04E+11	5.23E+00	2.48E+09	2.12E+09
1.65E-01	9.14E+10	9.26E+10	5.87E+00	2.14E+09	1.81E+09
1.86E-01	8.56E+10	8.66E+10	6.59E+00	1.77E+09	1.47E+09
2.08E-01	7.80E+10	7.86E+10	7.39E+00	1.49E+09	1.24E+09
2.34E-01	7.08E+10	7.14E+10	8.29E+00	1.23E+09	1.00E+09
2.62E-01	6.43E+10	6.47E+10	9.30E+00	1.01E+09	8.09E+08
2.94E-01	5.75E+10	5.76E+10	1.04E+01	8.64E+08	6.92E+08
3.30E-01	5.12E+10	5.12E+10	1.17E+01	7.18E+08	5.71E+08
3.70E-01	4.55E+10	4.54E+10	1.31E+01	5.79E+08	4.54E+08
4.16E-01	4.25E+10	4.22E+10	1.47E+01	4.76E+08	3.71E+08
4.66E-01	3.81E+10	3.78E+10	1.65E+01	3.79E+08	2.90E+08
5.23E-01	3.41E+10	3.37E+10	1.86E+01	3.02E+08	2.28E+08
5.87E-01	3.06E+10	3.01E+10	2.08E+01	2.47E+08	1.86E+08
6.59E-01	2.76E+10	2.71E+10	2.34E+01	1.97E+08	1.47E+08
7.39E-01	2.44E+10	2.39E+10	2.62E+01	1.55E+08	1.16E+08
8.29E-01	2.18E+10	2.12E+10	2.94E+01	1.19E+08	8.77E+07
9.30E-01	1.92E+10	1.85E+10	3.30E+01	9.13E+07	6.59E+07
1.04E+00	1.70E+10	1.63E+10	3.70E+01	6.78E+07	4.88E+07
1.17E+00	1.52E+10	1.46E+10			

**Table 3.4-11: Mission DDEF Depth Curves for Si and GaAs detectors**

**Equivalent Fluences in Si - PMAX-VOC**

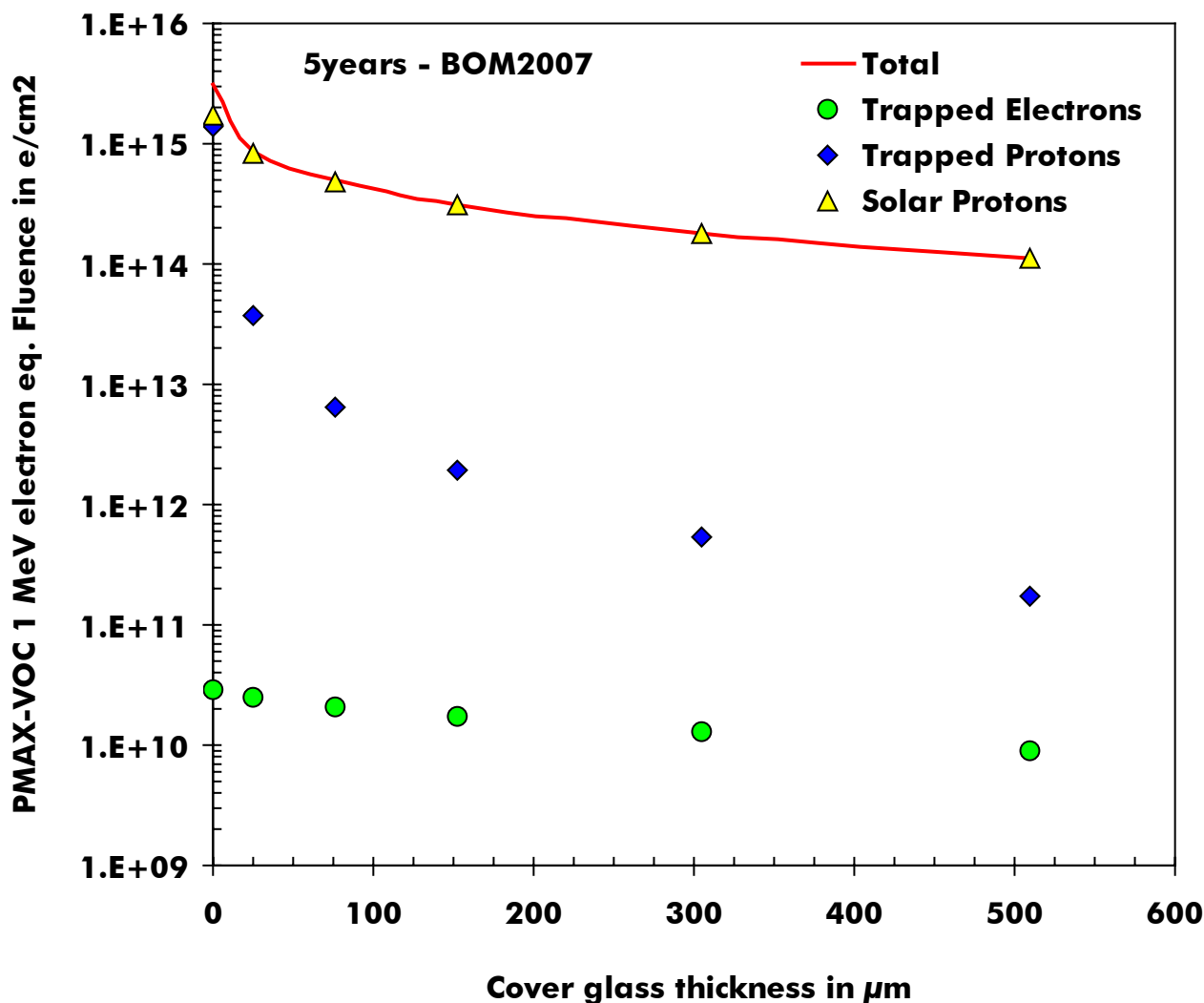

**Figure 3-34: Mission 1 MeV electron Equivalent Fluence for PMAX-VOC in Si**

PMAX-VOC Coverglass microns	1 MeV e/cm2 in Si			
	Total	Trapped Electrons	Trapped Protons	Solar Protons
0.00	3.10E+15	2.90E+10	1.40E+15	1.70E+15
25.41	8.57E+14	2.50E+10	3.70E+13	8.20E+14
76.36	4.97E+14	2.10E+10	6.50E+12	4.90E+14
152.27	3.12E+14	1.70E+10	1.90E+12	3.10E+14
305.00	1.81E+14	1.30E+10	5.40E+11	1.80E+14
509.09	1.10E+14	9.00E+09	1.70E+11	1.10E+14

**Table 3.4-12: Mission 1 MeV electron Equivalent Fluence for PMAX-VOC in Si**

**Equivalent Fluences in Si - ISC**

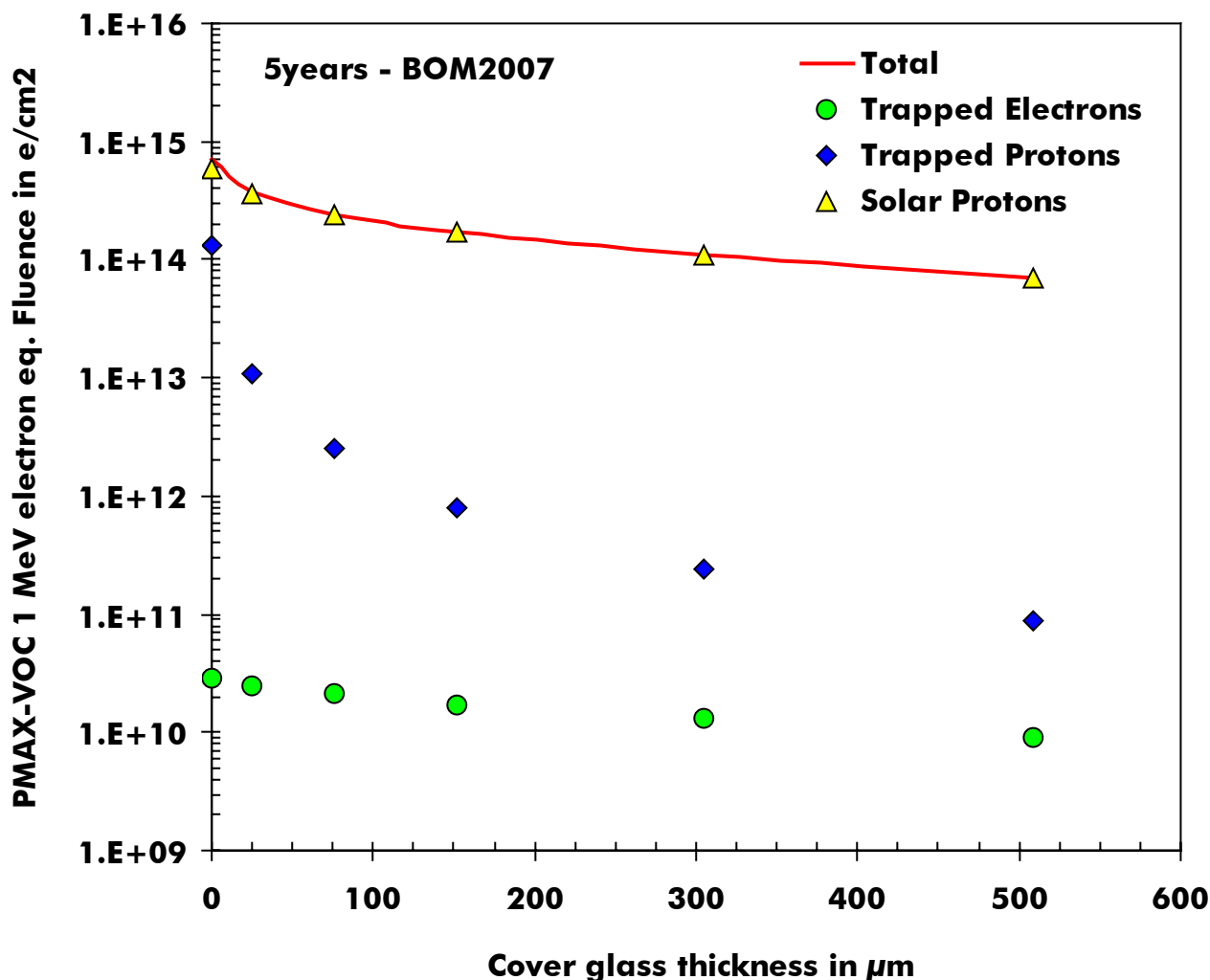
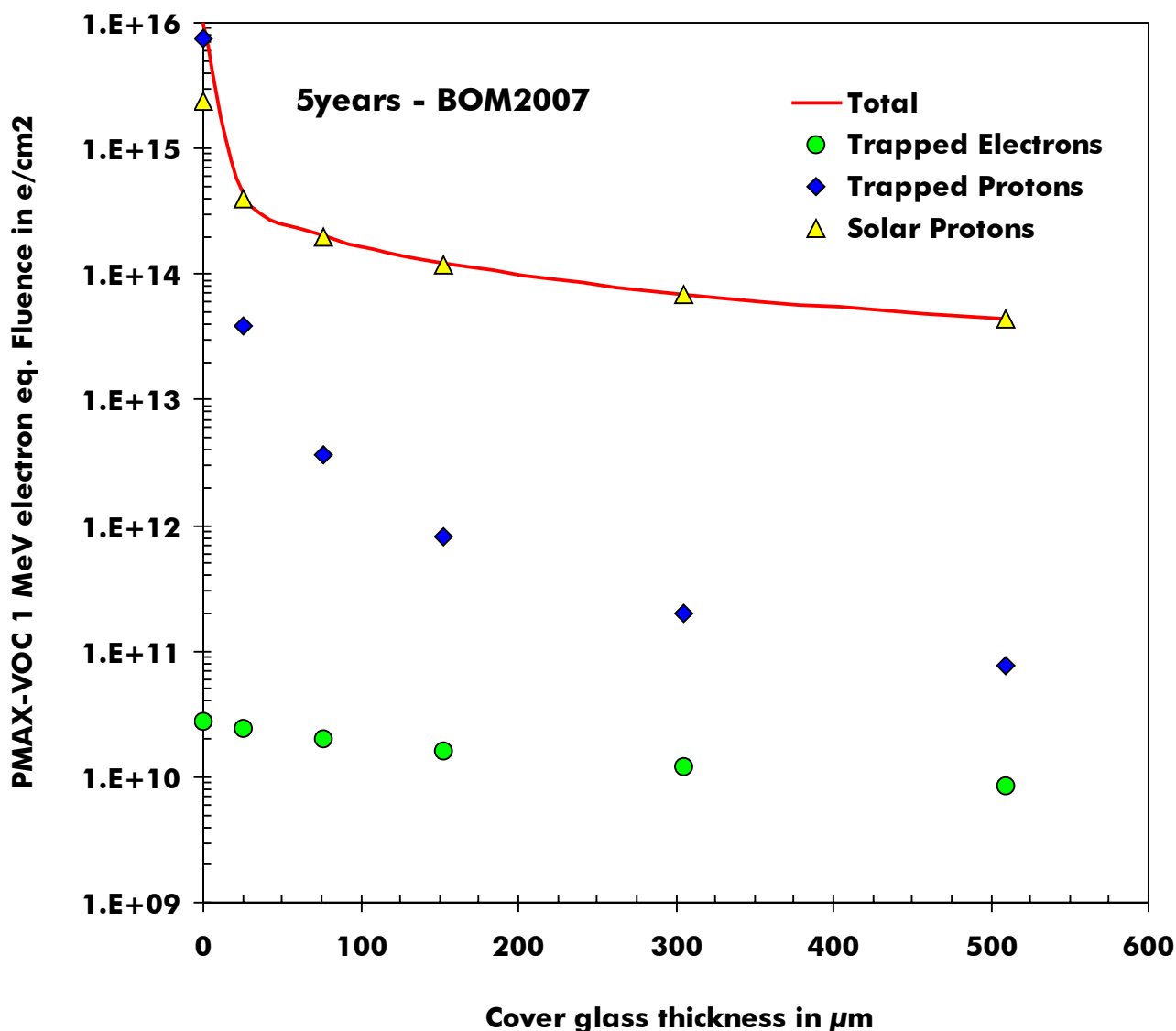

Figure 3-36: Mission 1 MeV electron Equivalent Fluence for ISC in Si

ISC Coverglass microns	1 MeV e/cm2 in Si			
	Total	Trapped Electrons	Trapped Protons	Solar Protons
0.00	7.10E+14	2.90E+10	1.30E+14	5.80E+14
25.41	3.71E+14	2.50E+10	1.10E+13	3.60E+14
76.36	2.43E+14	2.10E+10	2.50E+12	2.40E+14
152.27	1.71E+14	1.70E+10	8.00E+11	1.70E+14
305.00	1.10E+14	1.30E+10	2.40E+11	1.10E+14
509.09	7.11E+13	9.00E+09	8.90E+10	7.10E+13

Table 3.4-13: Mission 1 MeV electron Equivalent Fluence for ISC in Si

**Equivalent Fluences in GaAs - VOC**

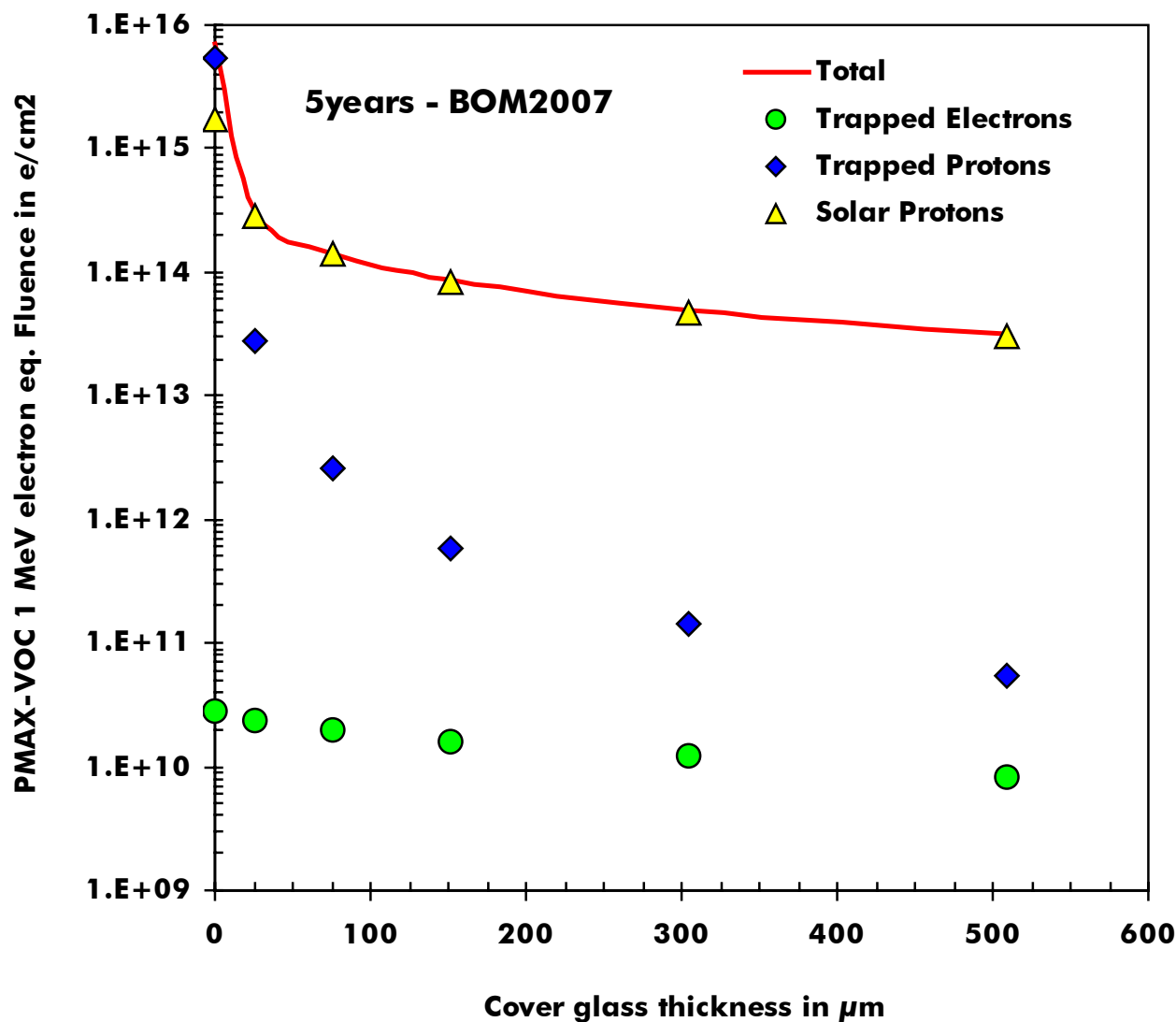

**Figure 3-38: Mission 1 MeV electron Equivalent Fluence for VOC in GaAs**

VOC Coverglass microns	1 MeV e/cm2 in GaAs			
	Total	Trapped Electrons	Trapped Protons	Solar Protons
0.00	9.80E+15	2.80E+10	7.40E+15	2.40E+15
25.41	4.39E+14	2.40E+10	3.90E+13	4.00E+14
76.36	2.04E+14	2.00E+10	3.60E+12	2.00E+14
152.27	1.21E+14	1.60E+10	8.10E+11	1.20E+14
305.00	6.82E+13	1.20E+10	2.00E+11	6.80E+13
509.09	4.41E+13	8.40E+09	7.60E+10	4.40E+13

**Table 3.4-14: Mission 1 MeV electron Equivalent Fluence for VOC in GaAs**

**Equivalent Fluences in GaAs - PMAX**



**Figure 3-40: Mission 1 MeV electron Equivalent Fluence for PMAX in GaAs**

PMAX Coverglass microns	1 MeV e/cm2 in GaAs			
	Total	Trapped Electrons	Trapped Protons	Solar Protons
0.00	7.00E+15	2.80E+10	5.30E+15	1.70E+15
25.41	3.18E+14	2.40E+10	2.80E+13	2.90E+14
76.36	1.43E+14	2.00E+10	2.60E+12	1.40E+14
152.27	8.56E+13	1.60E+10	5.80E+11	8.50E+13
305.00	4.82E+13	1.20E+10	1.40E+11	4.80E+13
509.09	3.11E+13	8.40E+09	5.40E+10	3.10E+13

Table 3.4-15: Mission 1 MeV electron Equivalent Fluence for PMAx in GaAs

**Equivalent Fluences in GaAs - ISC**

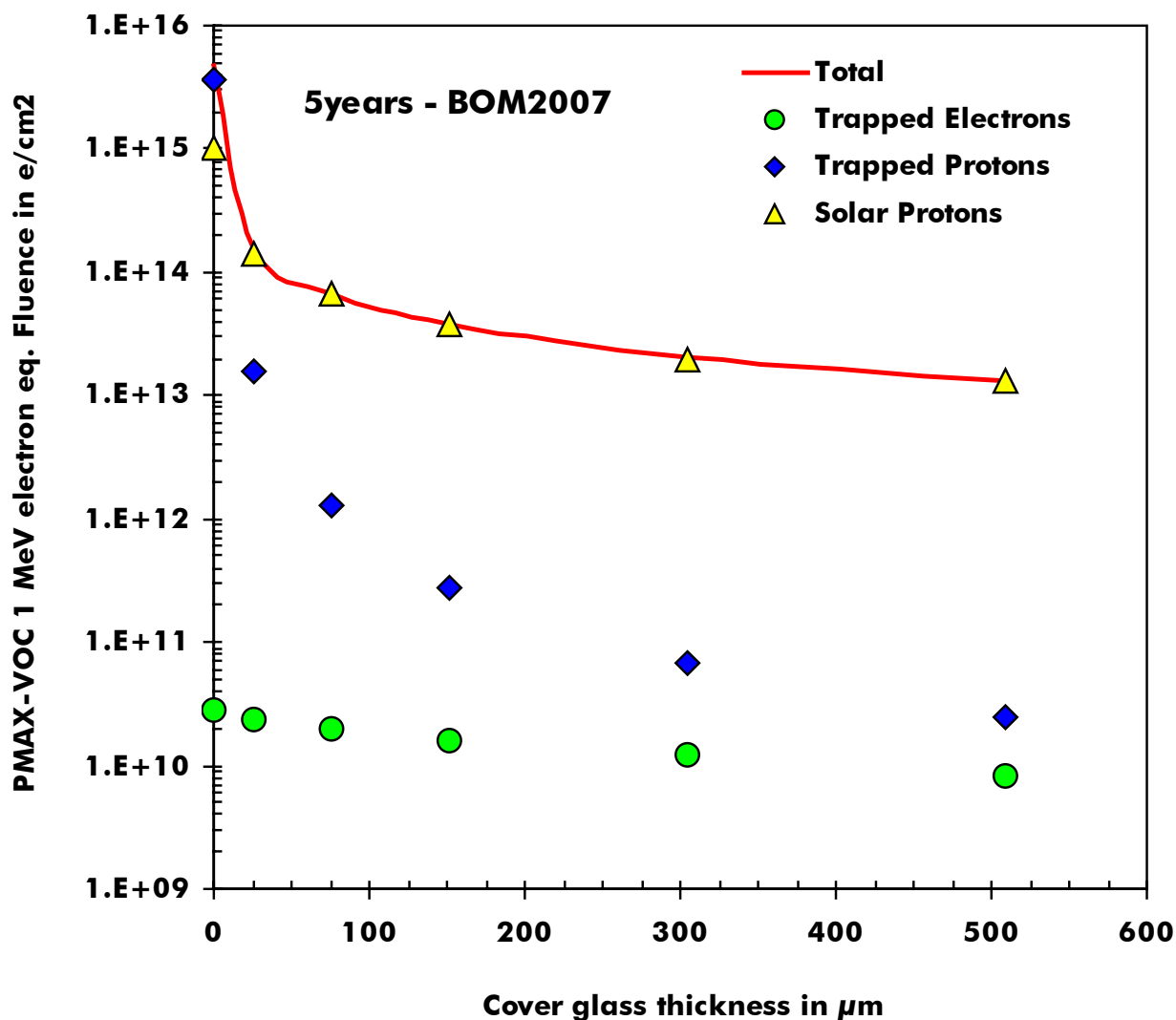

Figure 3-42: Mission 1 MeV electron Equivalent Fluence for ISC in GaAs

ISC Coverglass microns	1 MeV e/cm2 in GaAs			
	Total	Trapped Electrons	Trapped Protons	Solar Protons
0.00	4.70E+15	2.80E+10	3.70E+15	1.00E+15
25.41	1.56E+14	2.40E+10	1.60E+13	1.40E+14
76.36	6.83E+13	2.00E+10	1.30E+12	6.70E+13
152.27	3.83E+13	1.60E+10	2.80E+11	3.80E+13
305.00	2.01E+13	1.20E+10	6.80E+10	2.00E+13
509.09	1.30E+13	8.40E+09	2.50E+10	1.30E+13

**Table 3.4-16: Mission 1 MeV electron Equivalent Fluence for ISC in GaAs**

### 3.4.4.2.4 Electrostatic Charging

During the mission, the spacecraft will be submitted to the effects of plasma. In space, plasma extends from the ionosphere of the Earth to the far reaches of the solar system and encompasses plasmas of many different compositions, densities, and risk potentials. The plasma found at L2 and the orbits around L2 is that contained in solar wind. Solar wind plasma is essentially a neutral or cold plasma.

# Reference **ENVM-490**

[P:SCI-PT-RS-05991 - Ch.5#5.5.5.3-SENV-111 H/P

The spacecraft shall be compatible with a plasma with the following characteristics. This characteristics are preliminary and are TBC :

- Composition = 95% H + , 5% He ++ with equivalent electrons ;
- Density = 1-10 particles/cm<sup>3</sup> ;
- Velocity @ 450 km/s ;
- Energy (ions) @ 10 eV ;
- Energy (e - ) @ 50 eV.

# \*

This plasma is relatively benign compared to those at Low and Geosynchronous orbits and will generate a low surface charging potential.

# Reference **ENVM-500**

[P:SCI-PT-RS-05991 - Ch.5#5.5.5.3-SENV-111 H/P

Moreover, surface charging is also expected when the spacecraft passes through the radiation belts of the Earth, though this phase will not last very long. Assuming Geosynchronous orbit to be the worst case as regards plasma energy, the spacecraft shall be compatible with a plasma with the following characteristics:

- Density ( e - ) = 1.12 e - /cm<sup>3</sup> ;
- Density (ions) = 0.236 ions/cm<sup>3</sup> ;
- Energy (e - ) @ 12 keV ;
- Energy (ions) @ 29.5 keV.

# \*

This characteristics are preliminary and are TBC.

### 3.4.4.3 Solid particle environment

[P:SCI-PT-RS-05991 - Ch.5#5.5.7-SENV-215 H/P

The predicted solid particle environment in the vicinity of L2 is given in AD-10. All protection means for external items are left to be defined by the Contractor.

**Table 3.4-17: Deleted**

**Figure 3-44: Deleted**

# ENVIRONMENT AND TESTS REQUIREMENTS (EVTR)

**REFERENCE :** H-P-1-ASPI-SP-0030

**DATE :** 07-Oct-2004

**ISSUE :** 5.0

**PAGE :** 64/89

---

## 3.4.4.4 EMC

The satellites shall be designed to meet the requirements specified in AD- 1.



## 4. ENVIRONMENTAL TEST REQUIREMENTS

### 4.1 General

#### 4.1.1 Ambient conditions

# Reference **ENVT-010**

Unless otherwise specified herein, all tests required by this specification and conducted in ambient conditions shall be done in the conditions defined in § 3.2.4.

# \*

Actual ambient test conditions should be recorded regularly during the tests. In case of ambient conditions exceeding the allowable limits, the decision not to test or to halt any test in progress shall lie with the responsible Test Manager who must have adequate evidence that there will be no adverse influences on component performance. However, the temperature of the unit shall not be allowed to exceed the specified range.

#### 4.1.2 Accuracy of test apparatus

# Reference **ENVT-020**

The accuracy of the instrument and test equipment used to control or monitor the test parameters shall be verified periodically by calibration procedures.

# \*

#### 4.1.3 Test tolerances

# Reference **ENVT-030 b**

The maximum allowable tolerances on test conditions during environmental testing shall be as indicated in Table 4.1-1 unless otherwise specified (Relaxation of tolerance can be proposed to ALCATTEL for cost saving purpose).

Parameter	Measurement Range	Tolerances
Temperature	• -55°C to +180°C - maximum temperature - minimum temperature	0°C/+ 3°C - 3°C/0°C
	• below -55°C and above 10 K - maximum temperature - minimum temperature	0K/+1 K -1 K/0 K
	• below 10 K - maximum temperature - minimum temperature	0K/+0.1 K -0.1 K/0 K
Pressure	- p > 0,1 mbar	< ± 1 %
	- p < 0,1 mbar	± 10 %

# ENVIRONMENT AND TESTS REQUIREMENTS (EVTR)

REFERENCE : H-P-1-ASPI-SP-0030

DATE : 07-Oct-2004

ISSUE : 5.0

PAGE : 66/89

Parameter	Measurement Range	Tolerances
Solar intensity		± 3 %
Relative Humidity		+ 5 % RH
Static test	Force	0 % / 5 %
Sinusoidal Vibration	Acceleration/amplitude Frequency below 50 Hz Frequency above 50 Hz	0 % / +5 % ± 0.5 Hz ± 2 %
Random Vibration	Power Spectral Density (g <sup>2</sup> /Hz)  Overall g RMS	QUAL: -1 dB / +3 dB ACC: -3 dB / +1.5 dB  ± 10%
Acoustic Vibration	1/3 octave band  overall	-1.0 dB/3.0 dB (63 to 2000 Hz) -2.0 dB/4.0 dB (31.5 Hz) -1.0 dB/3.0 dB
Shock response	(Q=10) 1/6 octave band	± 3.0 dB
Test Duration		0 %/ 5 %
RF Power Level		< ± 0.3 dB
Spurious level	< -20 dBc and up to 80 dBc	< ± 0.5 dB
Frequencies	Audio < 20 kHz Video > 10 MHz Video < 10 Mz	10 ppm 1 ppm 0.01 ppm
Voltage	< 5 Volt > 5 Volt	≤ 0.2 % ≤ 0.5 %
Current	< 1 A > 1 A	≤ 0.5 % ≤ 0.1 %
DC Power		≤ 1.0 %
VSWR		0.2 dB
Leak Rate		±10 <sup>-5</sup> Pa m <sup>3</sup> s <sup>-1</sup> of Helium at 1013 hPa pressure differential

**Table 4.1-1: Maximum Allowable Test Tolerances**

# \*

## 4.1.4 Cleanliness of test equipment

# Reference **ENVT-040**

The inner cleanliness of the test equipment, as far as it can affect the cleanliness of the unit shall be checked and minimum cleanliness level has to be assured before, during and after each test.

# \*

# ENVIRONMENT AND TESTS REQUIREMENTS (EVTR)

REFERENCE : H-P-1-ASPI-SP-0030

DATE : 07-Oct-2004

ISSUE : 5.0

PAGE : 67/89

---

## ***4.1.5 Temperature stabilisation***

# Reference **ENVT-050 a**

---

Time shall be allowed for the unit to reach required temperature during testing. Temperature has been reached when all temperature readings have remained within measurement tolerance for more than 1 hour (TBC).

---

# \*

# ENVIRONMENT AND TESTS REQUIREMENTS (EVTR)

REFERENCE : H-P-1-ASPI-SP-0030

DATE : 07-Oct-2004

ISSUE : 5.0

PAGE : 68/89

## 4.2 System and module level TESTS

### 4.2.1 Environmental test summary

# Reference **ENVT-110 c**

The spacecraft and their modules shall be able to support the following tests to be performed at system level :

Test	Herschel		Planck	
	STM	PFM	STM	PFM
Sine vibrations	Q	A		A
Acoustic	Q	A		A
Shock test	X (*) (Q on unit)	N/A		X (*) (Q on unit)
Fit check	X	X		X
Mass properties	X	X		X
Alignments	X	X		X
Sun Simulation	Simulated by skin heaters	N/A		Simulated by skin heaters
Thermal Balance	X	Q (A for cryo)		Q (A for cryo)
Thermal Vacuum	X	A		A
Leak test	X	X		X
Instrument Cryogenic test	N/A	X		X
ESD	N/A	N/A		N/A
EMC R	N/A	Q		Q
EMC C	N/A	Q		Q
RF perfos.	N/A	N/A		LFI low freq.
IST	N/A	X		X
SFT	N/A	X		X
SW compatibility	N/A	X		X
SVT	N/A	SVT 1 & 2		SVT 1 & 2

X = test performed

- Q = at qualification level when relevant
- A = at acceptance level when relevant

N/A = no test at system level

(\*) final qualification achieved by analysis

# ENVIRONMENT AND TESTS REQUIREMENTS (EVTR)

REFERENCE : H-P-1-ASPI-SP-0030

DATE : 07-Oct-2004

ISSUE : 5.0

PAGE : 69/89

**Table 4.2-1: System environmental test summary**

# \*

# Reference **ENVT-113 b**

The Herschel and Planck service modules shall be able to support the following tests to be performed at module level :

Test	AVM	Herschel SVM		Planck SVM	
		STM	FM	STM	FM
Static test	N/A	X (*)	N/A		N/A
Sine & Acoustic	N/A	N/A	N/A		N/A
Shock test	N/A	N/A	N/A		N/A
Fit check	N/A	N/A	N/A		N/A
Mass properties	N/A	X	X (mass measurement only)		X (mass measurement only)
Alignments	N/A	X	X		X
Sun Simulation	N/A	X	N/A		N/A
Thermal Balance	N/A	X	N/A		N/A
Thermal cycling	N/A	N/A	N/A		N/A
Leak test (RCS)	N/A	X	X		X
ESD	N/A	N/A	N/A		N/A
EMC R	N/A	N/A	N/A		N/A
EMC C	X	N/A	X		X
RF perfos.	N/A	N/A	N/A		N/A
TTC RF diagram	N/A	N/A	N/A		N/A
IST	X	N/A	X		X
SFT	N/A	N/A	N/A		N/A
SW compatibility	X	N/A	X		X
SVT	N/A	N/A	N/A		N/A

N/A = test not performed at this level (covered by satellite testing)

X = test performed at this level

(\*) test performed on a dedicated primary structure covering both Herschel and Planck service modules.

**Table 4.2-4: SVM test plan**

# \*

# ENVIRONMENT AND TESTS REQUIREMENTS (EVTR)

REFERENCE : H-P-1-ASPI-SP-0030

DATE : 07-Oct-2004

ISSUE : 5.0

PAGE : 70/89

# Reference **ENVT-116 a**

The Herschel and Planck payload modules shall be able to support the following tests to be performed at module level :

Test	Herschel PLM		Planck PLM Telescope & Cryo Structure	
	EQM	PFM	CQM	PFM
Static Test	N/A	Q (*) (TBC)	Q (*) (TBC)	A (*) (TBC)
Low sine test	N/A	in «warm» condition	X	X
Sine & Acoustic	N/A	N/A	Q	A
Shock test	N/A	N/A	N/A	N/A
Fit check	N/A	N/A	N/A	N/A
Mass properties	N/A	N/A	X (TBC)	X (TBC)
Alignments	X	X	X	X
Sun Simulation	N/A	N/A	N/A	N/A
Thermal Balance	N/A	N/A	N/A	N/A
Thermal cycling	N/A	N/A	N/A	N/A
Leak test	X (He)	X (He)	N/A	N/A
Cryo testing	X	X	X	X (TBC)
ESD	N/A	N/A	N/A	N/A
EMC R	X (**)	N/A	N/A	N/A
EMC C	X	N/A	N/A	N/A
RF perfos.	N/A	N/A	N/A	N/A
TTC RF diagram	N/A	N/A	N/A	N/A
IST	IMT	X	N/A	N/A
SFT	X	X	N/A	N/A
SW compatibility	X	X	N/A	N/A
SVT	N/A	N/A	N/A	N/A

N/A = test not performed at this level (covered by satellite testing)

X = test performed at this level with:

Q= qualification level when relevant

A = acceptance level when relevant

(\*) at equipment level (struts, ...)

(\*\*) with external source

**Table 4.2-5: PLM test plan**

# \*

# ENVIRONMENT AND TESTS REQUIREMENTS (EVTR)

REFERENCE : H-P-1-ASPI-SP-0030

DATE : 07-Oct-2004

ISSUE : 5.0

PAGE : 71/89

---

## 4.2.2 Mechanical environmental tests

### 4.2.2.1 Static test

# Reference **ENVT-120**

---

The static test is performed at Structure Subsystem level in order to validate the design and the manufacturing of the Primary Structure with regards to Quasi-Static loads. Due to the commonality between Herschel and Planck primary structure, only one static load test will be performed, the test specimen being the Herschel primary structure and the applied loads being the envelope of Planck and Herschel static loads.

---

# \*

### 4.2.2.2 Sine vibration test levels

# Reference **ENVT-130**

---

These test shall be conducted in each of the three orthogonal direction, on the fully assembled spacecraft in configuration defined in RD-6 (Design and Development Plan).

---

# \*

# Reference **ENVT-140**

---

The satellite shall be mounted on the vibration adapter representative of the launcher interfaces. The clamp band shall be mechanically identical to a flight one.

---

# \*

# ENVIRONMENT AND TESTS REQUIREMENTS (EVTR)

REFERENCE : H-P-1-ASPI-SP-0030

DATE : 07-Oct-2004

ISSUE : 5.0

PAGE : 72/89

# Reference **ENVT-150**

[P:SCI-PT-RS-05991 - Ch.5#5.5.1-SENV-030 H/P

The levels define in Table 4.2-2 shall be applied at the base of the satellite (separation plane). Prior to (frequency search) and after (check-out) a test, a low level sine sweep shall be applied on all 3 axes. Level, frequency range and sweep rate shall be defined with the instrumentation by the structural analysis responsible in the relevant test specification.

The notching philosophy depends on results of coupled load analyses and is TBD.

The electronic units that are active at launch shall be operating during the tests.

Axis	Frequency range (Hz)	Qualification level (0-peak)	Acceptance level (0-peak)
Axial (X)	4 - 5	12.4 mm	9.9 mm
	5-100	1.25 g	1.0 g
Lateral (Y,Z)	2 - 5	9.9 mm	8.0 mm
	5-25	1.00 g	0.8 g
	25-100	0.80 g	0.6 g
Sweep rate		2 oct/min per axis	4 oct/min per axis

**Table 4.2-2: Sine vibration levels and duration**

# \*

## 4.2.2.3 Acoustic noise test levels

# Reference **ENVT-160**

These test shall be conducted on the fully assembled spacecraft in configuration defined in RD-6 (Design and Development Plan).

# \*



# ENVIRONMENT AND TESTS REQUIREMENTS (EVTR)

REFERENCE : H-P-1-ASPI-SP-0030

DATE : 07-Oct-2004

ISSUE : 5.0

PAGE : 73/89

# Reference **ENVT-170**

[P:SCI-PT-RS-05991 - Ch.5#5.5.1-SENV-030 H/P

The levels defined in Table 4.2-3 shall be applied to the overall satellite. The instrument shall be defined by the structural analysis responsible in the relevant test specification.

The electronic units that are active at launch shall be operating during the tests.

Octave band Centre Frequency (Hz)	Qualification Level (dB) Ref. 0 dB = $2 \times 10^{-5}$ Pa	Acceptance Level (dB) Ref. 0 dB = $2 \times 10^{-5}$ Pa	Test tolerance (dB)
31.5	132	128	-2,+4
63	134	130	-1,+3
125	139	135	-1,+3
250	143	139	-1,+3
500	138	134	-1,+3
1000	132	128	-1,+3
2000	128	124	-1,+3
Integrated level	146	142	-1,+3
Test duration	2 min	1 min	

**Table 4.2-3: Acoustic test levels and duration**

# \*

## 4.2.2.4 Shock tests

# Reference **ENVT-180 a**

Shock tests shall characterize the spacecraft structural behavior with ARIANE 5 flight shock representative environment. It shall be performed at Satellite AIT Contractor premises on the Herschel STM and on the Planck PFM. Baseline shock test is SHOGUN (SHOCK Generation UNit, supplied by Arianespace) followed by clampband release with drop of the ACU for the Herschel STM and only a clampband release test on Planck PFM.

# \*

The shock spectrum to be considered is given in Figure 3-5.

Notes :

- Details on these tests will be provided by «Shock Test Requirements Specification».

## 4.2.3 Thermal environment tests

# Reference **ENVT-200**

Thermal environment tests at system level shall consist in :

- Thermal balance,

# ENVIRONMENT AND TESTS REQUIREMENTS (EVTR)

REFERENCE : H-P-1-ASPI-SP-0030

DATE : 07-Oct-2004

ISSUE : 5.0

PAGE : 74/89

---

- Thermal vacuum on Herschel and Planck PFM.
- 

# \*

Details on these tests will be provided by the relevant «Thermal Test Requirements Specification».

## ***4.2.4 Electromagnetic compatibility tests***

Detail on these tests are described in document AD-1.

## 4.3 Subsystem and unit level TESTS

### 4.3.1 Verification/Test Sequence

Qualification and protoflight model shall be qualification tested, the flight models have to be acceptance tested.

# Reference **ENVT-060**

---

The tests on qualification model shall include as a minimum the following sequence :

- inspection,
- physical properties,
- initial full performance tests,
- shock tests,
- sine vibration,
- random vibration (qualification level, qualification duration),
- post vibration functional tests,
- temperature cycling thermal vacuum (qualification level, 8 (TBC) cycles),
- post temperature functional tests,
- EMC tests,
- final full performance tests,
- final inspection.

---

# \*

# Reference **ENVT-070**

---

The tests on protoflight model shall include as a minimum the following sequence :

- inspection,
- physical properties,
- initial full performance tests,
- sine vibration,
- random vibration (qualification level, acceptance duration),
- post vibration functional tests,
- temperature cycling thermal vacuum (qualification level, 4 (TBC) cycles),
- post temperature functional tests,
- EMC tests: limited to the conducted part if the radiated part is performed on EM,
- final full performance tests,
- final inspection.

---

# \*

# ENVIRONMENT AND TESTS REQUIREMENTS (EVTR)

REFERENCE : H-P-1-ASPI-SP-0030

DATE : 07-Oct-2004

ISSUE : 5.0

PAGE : 76/89

---

# Reference **ENVT-080**

---

The acceptance test sequence shall include as a minimum the following :

- inspection,
- physical properties,
- initial full performance tests,
- sine vibration (\*),
- random vibration (acceptance level, acceptance duration),
- post vibration functional tests,
- temperature cycling thermal vacuum (acceptance level, 4 (TBC) cycles),
- post temperature functional tests,
- EMC tests: limited to the conducted part,
- final full performance tests,
- final inspection.

(\*) The sine vibration tests shall be performed only in case of a subsystem/unit resonance frequency below 140 Hz.

---

# \*

## 4.3.2 Tests methods

---

# Reference **ENVT-210**

---

During all test to be performed, the test data and parameter values shall be continuously recorded.

---

# \*

### 4.3.2.1 Initial tests

---

# Reference **ENVT-220**

---

Prior to conducting any of the tests identified in this section, the test item shall be operated under ambient conditions, and a record shall be made of all data necessary to determine compliance with the required performance in the subsequent performance tests conducted before, during and after the environmental exposure. The only exceptions to this requirement are for those items which cannot be tested realistically in ambient conditions. In such cases, initial testing shall be designed to prove compliance as far as possible without causing damage to the test item.

---

# \*

### 4.3.2.2 Inspections and examinations

#### 4.3.2.2.1 Initial Inspection and examination

---

# Reference **ENVT-230**

---

The unit shall be examined to verify compliance with the following criteria :

# ENVIRONMENT AND TESTS REQUIREMENTS (EVTR)

REFERENCE : H-P-1-ASPI-SP-0030

DATE : 07-Oct-2004

ISSUE : 5.0

PAGE : 77/89

- Configuration,
- Interface Requirements,
- Parts, Materials and Process,
- Identification and Marking,
- Interchangeability,
- Workmanship.

# \*

## 4.3.2.2.2 Visual inspection

# Reference **ENVT-240**

The unit shall be examined visually to verify that there are no handling damages.

# \*

## 4.3.2.2.3 Final examination

# Reference **ENVT-250**

The unit shall be examined visually to verify compliance with :

- no handling damages,
- workmanship.

# \*

## 4.3.2.2.4 End Item acceptance

# Reference **ENVT-260**

After completion of all acceptance tests, the quality assurance responsible shall perform a final inspection of the hardware. Accepted items shall be appropriately sealed by the supplier's QA and released for storage or transportation.

# \*

# Reference **ENVT-270**

End item acceptance shall include proper review of the documentation.

# \*

## 4.3.2.3 Physical properties

# Reference **ENVT-280**

[P:SCI-PT-RS-05991 - Ch.5#5.5.2-SENV-050 H/P

# ENVIRONMENT AND TESTS REQUIREMENTS (EVTR)

REFERENCE : H-P-1-ASPI-SP-0030

DATE : 07-Oct-2004

ISSUE : 5.0

PAGE : 78/89

The mass shall be determined by weighing. The mass of the unit shall be in accordance with requirement. The moment of inertia and the centre of gravity may be determined by analysis (see AD- 2).

# \*

## 4.3.2.4 Performance tests

# Reference **ENVT-290**

[P:SCI-PT-RS-05991 - Ch.5#5.5.2-SENV-050 H/P

The functional requirements specified in § 4.3.1. have to be verified by test including application of expected voltages, impedances, frequencies, pulses and wave forms at the electrical interfaces.

# \*

## 4.3.2.5 Mechanical environment tests

### 4.3.2.5.1 General

# Reference **ENVT-300**

[P:SCI-PT-RS-05991 - Ch.5#5.5.2-SENV-050 H/P

Before and after the Vibration tests (Sinusoidal and random), a resonance search test shall be performed on each axis with the objective to demonstrate that the unit has not been degraded. Test parameters are as follows :

- Acceleration amplitude 0.5 g (TBC),
- Frequency 5 Hz to 2000 Hz (TBC),
- Sweep rate 2 octave per minute, one sweep up (TBC).

# \*

# Reference **ENVT-310**

[P:SCI-PT-RS-05991 - Ch.5#5.5.2-SENV-050 H/P

The unit shall be mounted on a rigid vibration adapter. Prior to installation of the unit to be tested, an empty fixture vibration test shall be performed.

# \*

# Reference **ENVT-320**

[P:SCI-PT-RS-05991 - Ch.5#5.5.2-SENV-050 H/P

Functional tests shall be conducted after full level exposure (including low levels) in the three axes.

# \*

# Reference **ENVT-330**

[P:SCI-PT-RS-05991 - Ch.5#5.5.2-SENV-050 H/P

Electronic units active at launch shall be operating during the tests and limited functional tests shall be conducted during full level exposure.

# ENVIRONMENT AND TESTS REQUIREMENTS (EVTR)

REFERENCE : H-P-1-ASPI-SP-0030

DATE : 07-Oct-2004

ISSUE : 5.0

PAGE : 79/89

# \*

## 4.3.2.5.2 Sinusoidal vibration test levels

# Reference **ENVT-340 a**

[P:SCI-PT-RS-05991 - Ch.5#5.5.1-SENV-025 H/P

The levels given in Table 4.3-1 shall be used for sinusoidal vibration qualification. These levels are defined as minimum threshold to be applied on all SVM equipments.

The input levels should be notched, after approbation at system level. Notching should be allowed in order not to exceed loads and moments at the interface with the Structure. These loads and moments are based on Quasi-Static Loads defined for each unit (see GDME-280 of AD-2). Notching requests shall be managed via the RFW process (see AD-3).

Sweep rate shall be 2 Oct/min per axis for qualification and 4 Oct/min per axis for acceptance.

Fuel tanks sinusoidal qualification levels have to be defined by the SVM Contractor in RD-17 and approved at System level.

	Frequency (Hz)	Qualification level	Acceptance level
In box mounting plane	5 - 22.5 Hz	+/- 10 mm	+/- 8 mm
	22.5 - 100 Hz	20 g	16 g
Perpendicular to box mounting plane	5 - 25 Hz	+/- 10 mm	+/- 8 mm
	25 - 100 Hz	25 g	20 g

**Table 4.3-1: Sinusoidal Vibration Levels for equipments in Herschel and Planck SVM**

# \*

## 4.3.2.5.3 Random vibration test levels

The random vibration test levels given in this section are preliminary and TBC.

# Reference **ENVT-350 b**

The levels apply at the interface with the Structure. The frequency range and levels depend on the mass of the Subsystem or units considered as first order mass system.

If brackets or fixation devices are provided with the unit, the interface is the bracket/fixation device interface.

For units belonging to the same subsystem, delivered in more than one box but accommodated closely on the same structure part (i.e. panels), the mass to be considered is the total mass of the grouped units.

The lateral axes are in the plane of the mounting plane, the vertical axis is perpendicular to the mounting plane.

The input levels should be notched, after approbation at system level. Notching should be allowed in order not to exceed loads and moments at the interface with the Structure. These loads and moments are based on Quasi-Static Loads defined for each unit (see GDME-280 of AD-2). Notching requests shall be managed via the RFW process (see AD-3).

The test duration shall be 2 min per axis.

# ENVIRONMENT AND TESTS REQUIREMENTS (EVTR)

REFERENCE : H-P-1-ASPI-SP-0030

DATE : 07-Oct-2004

ISSUE : 5.0

PAGE : 80/89

The qualification levels apply on STM, EM, QM or EQM pending on model philosophy.

The acceptance levels applied on FMs are qualification levels divided by a factor 1.5625 for PSD and 1.25 for the global level in g RMS. The test duration shall be 1 min per axis.

Units applying PFM philosophy shall be tested at qualification level and acceptance duration.

Qualification random levels for SVM equipments have to be defined by SVM Contractor in RD-17 and approved at System level.

## Levels specific to Herschel

The levels in the Table 4.3-2 have to be applied to the CFE housed in the Herschel SVM:

Frequency Range	Qualification levels
20-100 Hz	+3 dB/oct
100-300 Hz	See next table
300-2000 Hz	-5 dB/oct

Item	Mounted Panel	Out of Plane Level [g <sup>2</sup> /Hz]	In plane Level [g <sup>2</sup> /Hz]
VMC <sup>(1)</sup>	[+Z panel]	0.68	0.4
CCU	[-Z panel]	0.2	0.1
SREM		0.69	0.22

(1): see Figure 4.3-2a.

**Table 4.3-2: Random levels for the CFE housed in the Herschel SVM**

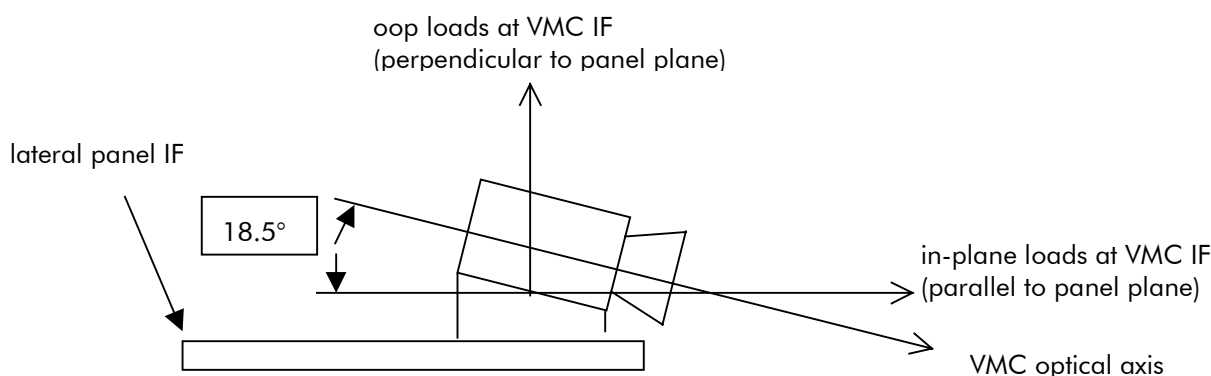

**Figure 4.3-2a: VMC accommodation on Herschel SVM**

## Levels specific to Planck

The levels in Table 4.3-3 have to be applied to the CFE housed in the Planck SVM:



# ENVIRONMENT AND TESTS REQUIREMENTS (EVTR)

REFERENCE : H-P-1-ASPI-SP-0030

DATE : 07-Oct-2004

ISSUE : 5.0

PAGE : 81/89

Frequency Range	Qualification levels
20-100 Hz	+3 dB/oct
100-300 Hz	See next table
300-2000 Hz	-5 dB/oct

Item	Mounted Panel	Out of Plane Level [g <sup>2</sup> /Hz]	In plane Level [g <sup>2</sup> /Hz]
FOG	[shear wall +Y+Z (-Z side)]	1	0.5
SREM	[+Y+Z panel]	0.69	0.22
VMC <sup>(1)</sup>		0.68	0.4

(1): see Figure 4.3-2b.

**Table 4.3-3: Random levels for the CFE housed in the Planck SVM**

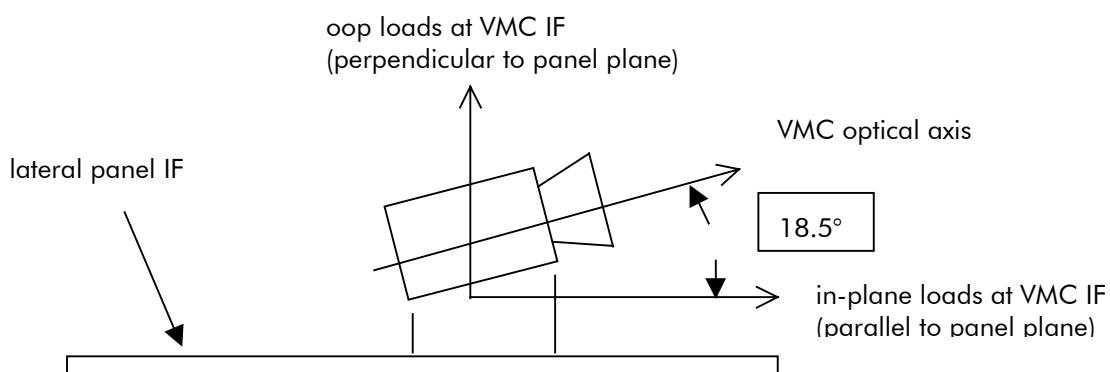

**Figure 4.3-2b: VMC accommodation on Planck SVM**

# \*

**General case by default for single items in SVM**

# ENVIRONMENT AND TESTS REQUIREMENTS (EVTR)

REFERENCE : H-P-1-ASPI-SP-0030

DATE : 07-Oct-2004

ISSUE : 5.0

PAGE : 82/89

## 4.3.2.5.4 Shocks at unit level

# Reference **ENVT-370 b**

Each unit mounted in the SVM (incl. Instruments warm units) shall undergo a shock test. The qualification levels are to be applied at the unit baseplate interface. Out-of-plane and in-plane shock levels are supposed to be identical.

Shock qualification levels for SVM equipments have to be defined by the SVM Contractor in RD-17 and approved by the Prime.

The levels defined in Table 4.3-5 have to be applied to the CFE housed in the SVM.

	Frequency (Hz)	Shock Qualification Level (g)	
		CCU, SREM, FOG	VMC
Radial and Longitudinal Direction	100	20	20
	200	200	200
	300	320	320
	500	650	650
	600	800	800
	1 000	1 200	1 200
	2 000	2 000	1 800
	10 000	2 000	1 800

**Table 4.3-5: Shock qualification levels for the CFE housed in the SVM**

# \*

# Reference **ENVT-373**

Each unit mounted in the HEPLM (incl. Instruments cold units) shall undergo a shock test. The qualification levels to be applied at the unit baseplate interface shall be derived by the H-EPLM Contractor from the shock qualification levels defined in Table 4.3-7 at the interface with the H-EPLM strut support located at 970 mm from the launcher interface plane. Out-of-plane and in-plane shock levels are supposed to be identical.

	Frequency (Hz)	Shock Qualification Level (g)
Radial and Longitudinal Direction	100	25
	350	350
	1 000	2 000
	3 000	2 000
	10 000	1 500

**Table 4.3-7: Shock qualification levels at the H-EPLM interface**

# ENVIRONMENT AND TESTS REQUIREMENTS (EVTR)

REFERENCE : H-P-1-ASPI-SP-0030

DATE : 07-Oct-2004

ISSUE : 5.0

PAGE : 83/89

# \*

# Reference **ENVT-376**

Each unit mounted in the PPLM (incl. Instruments cold units) shall undergo a shock test. The qualification levels to be applied at the unit baseplate interface shall be derived by the PPLM Contractor from the shock qualification levels defined in Table 4.3-8 at the interface with the PPLM strut support located at 970 mm from the launcher interface plane. Out-of-plane and in-plane shock levels are supposed to be identical. Interface shocks for BEU, Telescope and V-grooves shall be those of Table 4.3-8.

	Frequency (Hz)	Shock Qualification Level (g)
Radial and Longitudinal Direction	100	25
	350	350
	1 000	2 000
	3 000	2 000
	10 000	1 500

**Table 4.3-8: Shock qualification levels at the PPLM interface**

# \*

## 4.3.2.6 Thermal environment tests

### 4.3.2.6.1 Qualification thermal vacuum tests

The thermal vacuum tests are required to evaluate and demonstrate the functional performance of the units under the extreme and nominal modes of operation while in simulated vacuum and at temperatures more extreme than flight guaranteed temperatures. The purpose of the more severe temperatures stress is to demonstrate a design safety margin and to accelerate failure in marginal design.

# Reference **ENVT-380**

The evaluation and demonstration of the correct behaviour of Subsystem or unit at Maximum/Minimum operating temperatures shall be done at the beginning of this test as represented in Figure 4-1 and shall be reflected in the relevant Subsystem or unit test documentation.

# \*

# ENVIRONMENT AND TESTS REQUIREMENTS (EVTR)

REFERENCE : H-P-1-ASPI-SP-0030

DATE : 07-Oct-2004

ISSUE : 5.0

PAGE : 84/89

# Reference **ENVT-390 b**

Performance characteristics parameters of each unit shall be measured :

- at a pressure equal or less than  $1.33 \cdot 10^{-3}$  Pa,
- under the temperature conditions defined:
  - by the SVM Contractor for the SVM units;
  - in Table 4.3-6 for the units housed in the SVM and seen as CFE by the SVM Contractor.

The temperature monitoring is made at the unit Temperature Reference Point (TRP).

Unit Definition	Operating Mode		Non Operating Mode		Start Up	
	TO-MIN	TO-MAX	TNO-MIN	TNO-MAX	TSU-MIN	TSU-MAX
<b>Herschel units</b>						
CCU	-20	+50	-30	+60	-30	+60 TBC
<b>Planck units</b>						
FOG	TBD	TBD	TBD	TBD	TBD	TBD
<b>Common units</b>						
VMC	-20	+60	-30	+60	-30	+60 TBC
SREM	-20	+60	-55	+100	-20	+100 TBC

**Table 4.3-6: Qualification temperatures for the CFE housed in the SVM**

# \*

# Reference **ENVT-400**

The thermal cycle is shown in Figure 4-1. The number of cycle is 8 for qualification and 4 for acceptance. The maximum and minimum operating temperatures shall be maintained during 2 hours after the permanent state temperature establishment.

Health parameters shall be continuously checked during all permanent and transient states to look for any intermittent behaviour. For the permanent state, unit performances shall be performed once the steady state is reached.

Cold start-up capability shall be demonstrated on the first and last cycles.

# ENVIRONMENT AND TESTS REQUIREMENTS (EVTR)

REFERENCE : H-P-1-ASPI-SP-0030

DATE : 07-Oct-2004

ISSUE : 5.0

PAGE : 85/89

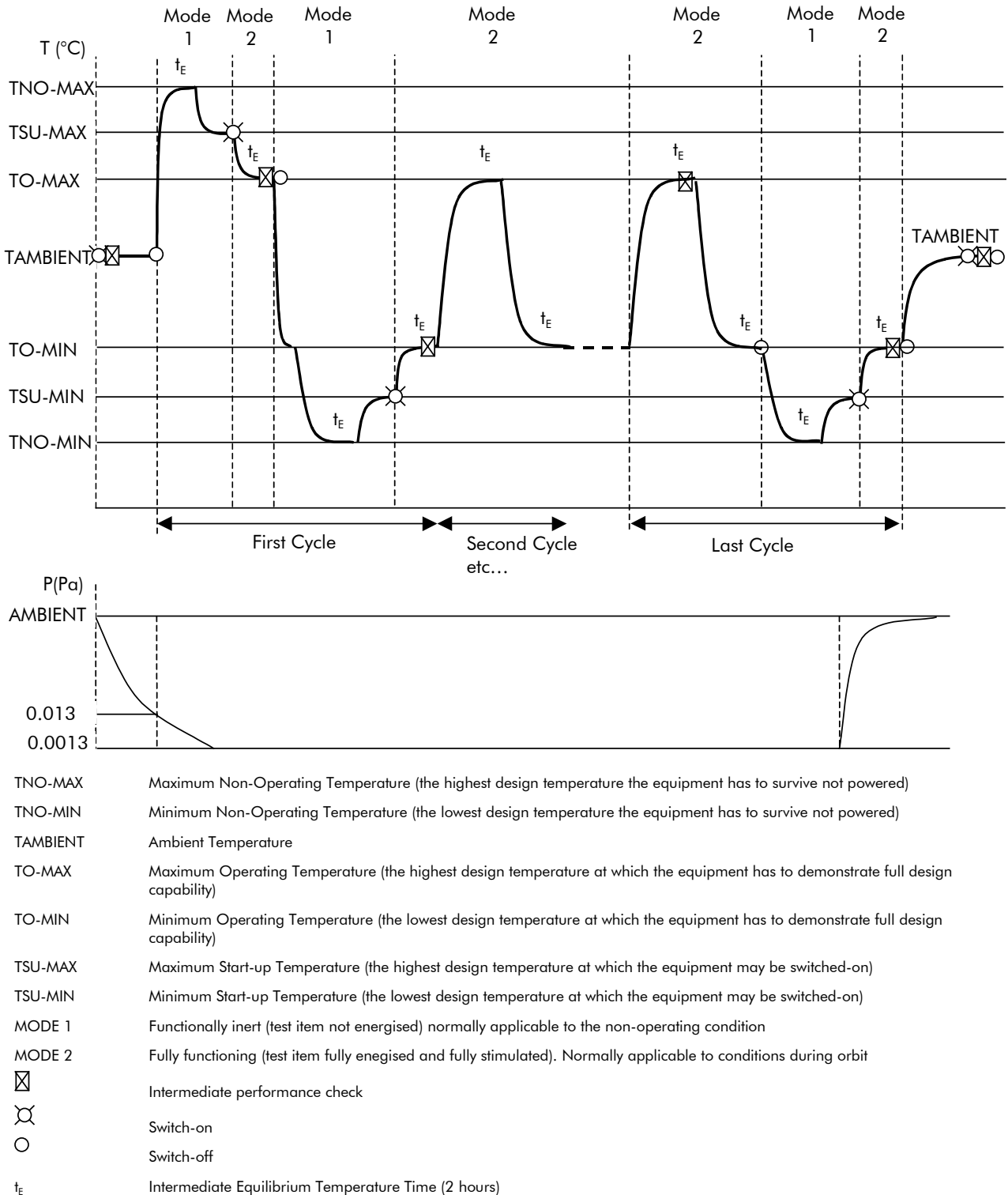

Figure 4-1: Temperature cycling during thermal test

# \*

# ENVIRONMENT AND TESTS REQUIREMENTS (EVTR)

REFERENCE : H-P-1-ASPI-SP-0030

DATE : 07-Oct-2004

ISSUE : 5.0

PAGE : 86/89

## 4.3.2.6.2 Acceptance thermal vacuum tests

# Reference **ENVT-410**

Thermal vacuum acceptance tests are the same as for the qualification vacuum tests except temperature limits which are 5 °C below the maximum and 5°C above the minimum qualification temperature limits.

The number of cycles is reduced to 4.

# \*

## 4.3.2.6.3 Corona tests

The purpose of the corona test is to verify that no permanently damaging electrical discharge occurs during transition to vacuum conditions.

# Reference **ENVT-420**

This test is only applicable to units which are operating during launch phase. It is applicable to units with internal voltages of more than 70 V and to RF power units.

# \*

# Reference **ENVT-430**

While the test chamber is evacuated, these units will be put on and their operations checked.

# \*

# Reference **ENVT-440**

During the vacuum establishment, the chamber pressure must be maintained for a short period of time at a value of 13.3 Pa and then reduced to  $1.33 \cdot 10^{-3}$  Pa (pressure of vacuum temperature test)

# \*

# Reference **ENVT-450**

During the corona test, the temperature will be near the ambient temperature. The unit shall be continuously monitored from the start with pump down, until  $1.33 \cdot 10^{-3}$  Pa is reached.

# \*

# Reference **ENVT-460**

The time to reach  $1.33 \cdot 10^{-3}$  Pa will be in accordance with the launch pressure time profile (see Figure 3-10).

# \*

## 4.3.2.7 Operating time

# Reference **ENVT-090**

Mechanisms ad ON/OFF operating shall be submitted to a cumulated number of actuations to be proposed by the supplier. It shall be representative of the in-orbit operating conditions and selected in order to avoid infant mortality.

# ENVIRONMENT AND TESTS REQUIREMENTS (EVTR)

REFERENCE : H-P-1-ASPI-SP-0030

DATE : 07-Oct-2004

ISSUE : 5.0

PAGE : 87/89

---

# \*

## 4.3.3 EMC-tests

Refer to AD- 1.

## 4.4 Test documentation

### 4.4.1 Test Procedures

# Reference **ENVT-100**

The Subcontractor shall establish procedures for performing all required tests in accordance with detailed test plans approved by the Prime Contractor. The test plans shall be based upon the specified performance, a failure modes and effects analysis, and the test requirement. The test procedures to be used in conducting required tests shall be detailed so that there is no doubt as to what is to be done. The pass-fail test criteria shall be determined prior to the start of every test. Pattern or lot associated failures that may occur shall be identified as potentially critical failures. Corrective action for potentially critical failures, including retest requirements, shall be approved by the Prime Contractor. The test plans and procedures shall provide traceability to the test requirements.

---

# \*

### 4.4.2 Test Reports

# Reference **ENVT-470**

Following completion of formal tests, test reports shall be prepared as defined in the Statement of Work.

---

# \*

### 4.4.3 Test Failure

# Reference **ENVT-480**

If a unit fails, malfunctions or if out-of-tolerance performance occurs during or after a test, the test shall be discontinued as appropriate and a NCR has to be issued. A NRB shall be held with the Prime (see AD- 3).

---

# \*

### 4.4.4 Failure Definition

A failure shall include, but not be limited to, an occurrence of any of the following :

- a. unit performance functionally beyond the design limits, test specification, criteria, or procedures. This applies to qualification, and acceptance tests.
- b. Intermittent or erratic unit performance.
- c. Necessity of repeated adjustment to sustain acceptable unit operation, initial or setup adjustments excepted.

# ENVIRONMENT AND TESTS REQUIREMENTS (EVTR)

**REFERENCE :** H-P-1-ASPI-SP-0030

**DATE :** 07-Oct-2004

**ISSUE :** 5.0

**PAGE :** 88/89

---

- d.** unit operation which has unexplainable drift from initial or setup performance conditions. This applies even though unit performance may still be within specification limits.
- e.** Overstress of end-item hardware caused by test equipment when an evaluation of the overstress has not or cannot be ascertained.
- f.** Part failure.
- g.** Any deviation with respect to the Test Procedure as agreed during the TRR.
- h.** Any failure of test equipment.

## ***4.4.5 Test Failure Procedures***

The Test Failure Procedure to be applied is defined in PA applicable documents.



## APPENDIX 1 : AEROTHERMAL FLUX NUMERICAL VALUES

The Appendix 1 is distributed on a separate Microsoft Excel 97 electronic file named "h-p-1-aspi-sp-0030\_4\_1 Appendix1.xls".

The Excel file contains the Ariane 5 ECA aerothermal flux profiles for the three following cases :

- optimum case
- sub-optimum case corresponding to an ascent where the line of apsides is shifted by  $-7.5^\circ$  (perigee Eastward shift)
- sub-optimum case corresponding to an ascent where the line of apsides is shifted by  $-15^\circ$  (perigee Eastward shift)

Each case contains the following data :

- Time (s),
- Altitude (m),
- Relative velocity (m/s),
- Aerothermal flux ( $W/m^2$ ).

The data begin at the time of fairing jettisoning.

**END OF DOCUMENT**