



SUBJECT: SPIRE Data ICD

PREPARED BY: K.J. King

DOCUMENT No: SPIRE-RAL-PRJ-001078

ISSUE: Issue 2.0

Date: 15th November 2004

APPROVED BY:

Checking Engineer (IFSI) R. Cerulli	
OBS Engineer (IFSI) S. Molinari	
Project Manager (IFSI) R. Orfei	
Operations Scientist S. Sidher	
Instrument Scientist B.M. Swinyard	
Instrument Development Manager E.C. Sawyer	



Distribution

R. Orfei	IFSI
R. Cerulli	IFSI
S. Molinari	IFSI
J-L Augerres	CEA, Saclay
C. Cara	CEA, Saclay
S. D. Sidher	RAL
B. M. Swinyard	RAL
K. J. King	RAL
J.A. Long	RAL



Change Record

ISSUE	DATE	
Issue 1.0 Draft 1	15 th January 2002	Original Draft
Issue 1.0 Draft 2	15 th January 2003	<p>Updated Draft for DPU AVM Acceptance Test</p> <p>Section 1.1: Updated Scope description</p> <p>Section 1.3.2: Updated document references and added RD08</p> <p>Section 2.1.3: Added note about TIME contents</p> <p>Section 2.2: Renamed APID5</p> <p>Section 2.3: included details of which parts of the 1553 interface protocol are used</p> <p>Section 3.1: Updated Telecommand service usage</p> <p>Section 3.2.3: Defined both Housekeeping and Diagnostic reports. There are now 4 of each with 2 housekeeping and 1 diagnostic report pre-defined in the OBS</p> <p>Section 3.2.3.1: Updated definition of service (3,1) to send Table_ID as a parameter. This allows different SIDs for the same Table_ID</p> <p>Section 3.2.3.2: Service (3,2) set to Not Used</p> <p>Section 3.2.3.3: Service (3,3) now defined</p> <p>Section 3.2.3.4: Service (3,4) set to Not Used</p> <p>Section 3.2.3.5: Service (3,9) now defined</p> <p>Section 3.2.3.6: Service (3,11) set to Not Used</p> <p>Section 3.2.6.1: Memory addressing changed to use 8 bit Memory ID and 24 bit address</p> <p>Section 3.2.6.2: Memory addressing changed to use 8 bit Memory ID and 24 bit address</p> <p>Section 3.2.6.3: Memory addressing changed to use 8 bit Memory ID and 24 bit address</p> <p>Section 3.2.8.1.2-4: Deleted Cooler, SCAL and 300mk control commands – they are now implemented in software-driven VMs</p> <p>Section 3.2.8.2.2-4: Deleted Cooler, SCAL and 300mk control commands – they are now implemented in software-driven VMs</p> <p>Section 3.2.8.3.1: Changed Load_Table command to Set_Table, with consequent changes to parameters</p> <p>Section 3.2.8.3.2: Changed parameters</p> <p>Section 3.2.8.3.3: Changed parameters</p> <p>Section 3.2.8.3.6: Inserted commands to start and stop software-driven VMs</p> <p>Section 3.2.8.3.20: Deleted data packing command – data frames are packed into science packets until they are full (unless a flush command is received)</p> <p>Section 3.2.9.1: Change to packet definition to all Ack field to be changed</p> <p>Section 3.2.14.1: Service (14,1) now defined</p> <p>Section 3.2.14.2: Service (14,2) now defined</p> <p>Section 3.2.14.3: Service (14,3) now defined</p> <p>Section 3.2.17.1: Updated command description</p> <p>Section 3.2.20.4: This telecommand is no longer used – OTF and TSF provided by ground processing</p> <p>Section 3.2.22: Context Service not used</p> <p>Section 4.1: table updated to reflect changes to services</p> <p>Section 4.2.1.6: Updates Error code table</p> <p>Section 4.2.3.2: Added Critical Housekeeping Report definition</p> <p>Section 4.2.3.3: Updated Nominal Housekeeping Report definition</p> <p>Section 4.2.3.4: Added Detector Housekeeping Report definition</p> <p>Section 4.2.5.1: Removed OTF and TSF reports and added definition</p>



Project Document

SPIRE Data ICD

Ref: SPIRE-RAL-PRJ-001078

Issue: Issue 2.0

Date: 15th November 2004

Page: 5 of 143

		<p>of report identified so far Section 4.2.5.2: Added definition of reports Section 4.3.5.3: Removed Error/Alarm report definition – they are not used as the ground does not remain in contact with the spacecraft Section 4.2.6: Defined Memory Dump reports Section 4.2.8: defined Function Activity Report Section 4.2.14: Defined Packet Generation Status Report Section 4.2.17: Defined Link connection Report Section 4.2.21: Science Data packet definition updated Section 4.2.22: Context Saving Service not used Section 5.1.1: Updated TC Parameter List Section 5.1.3: Updated TC Parameter Constraints</p> <p>Added commands to select science data Added Appendix D - description of science data processing</p>
Issue1.1 Draft 1	31 st July 2003	<p>Version issued for CQM Testing. This Version corresponds to the version 1.0 of the DRCU ICD.</p> <p>Section 1.3.1: Added IID-Part A to Applicable Documents Section 3.2.8.1: Added Launch Latch function to follow required implementation of arm-fire procedure for critical commands Added Booting Function Section 3.2.8.2: Added Launch Latch function to follow required implementation of arm-fire procedure for critical commands Added Booting Function Section 3.2.8.3: Added commands to engage/release Launch Latch Added Load_TC_and_Boot command Modified Force_Boot command Function and Activity IDs Defined Selection commands Section 3.2.20: Removed use of Information Distributioun Service, 20 Section 4.1: Removed Diagnostic Housekeeping packets from table Section 4.2.1.2.1: Updated TM(1,2) error message format to conform to new PS_ICD Section 4.2.1.2.2: Added Packet Content Error code for Illegal Functio and Activity IDs Section 4.2.1.6: Removed Illegal Function and Activity ID errors from the TC Failure report – they ar enow reported as TC Acceptance Failures Section 4.2.3.1: Removed Detector Housekeeping report from table Section 4.2.3.2: Updated Critical Housekeeping Report table to reflect Issue 1.0 of DRCU ICD Section 4.2.3.3: Updated Nominal Housekeeping Report table to reflect Issue 1.0 of the DRCU ICD Section 4.2.3.4: Deleted Detector Housekeeping Report – offsets are no longer able to be read as housekeeping parameters and can be obtained via a science data report Section 4.2.5.1: Updated event report format to conform to AD01 Updated DPU error packets to conform to User Manual description Section 4.2.5.1.2: Updated Peak-up Report format to comply with agreed interface (to be included in IID-A) Section 4.2.5.2: Updated to reflect new format for event packets in AD01 and consolidated TM(5,2) event packets into one format Added Boot ROM Telemetry event packet Section 4.2.5.3: updated to include all BOOT SW generated telemetry packets (ref RD10) Section 4.2.7: Defined Function Activity Reports Section 4.2.14: Modified format to conform to AD01</p>



Project Document

SPIRE Data ICD

Ref: SPIRE-RAL-PRJ-001078

Issue: Issue 2.0

Date: 15th November 2004

Page: 6 of 143

		<p>Section 4.2.16: Added Time to test service TM(17,2) packet</p> <p>Section 4.2.20: Removed use of Information Distribution Service, 20</p> <p>Section 4.2.21.1.3: Updated contents of SMEC Block</p> <p>Section 4.2.21.1.4: Updated contents of BSM Block</p> <p>Section 4.2.21.1.5: Defined contents of SCU Block</p> <p>Section 4.2.21.3: Defined New Test Pattern Blocks Defined MCU Engineering Block</p> <p>Appendix D: Replaced with Pixel Maps</p>
Issue 1.1 Draft 2	10 th August 2003	<p>Section 3.1: Removed HSK packet definition commands from Table</p> <p>Section 3.2.3: Removed HSK packet definition commands from Service 3 (moved to Service 8)</p> <p>Section 3.2.8.1.11: Added HSK Function</p> <p>Section 3.2.8.1.11: Added HSK Function</p> <p>Section 3.2.8.3: Added HSK packet definition commands</p> <p>Section 3.2.8.3.31 & 32: updated Selection commands to use SELECTID</p> <p>Section 4.2.1.6: modified TM(1,8) error codes for housekeeping packet definition commands</p> <p>Section 4.1.5.1.6: Updated Frame ID Error event packet –removed spare parameter</p> <p>Section 4.1.5.1.7: Updated Frame Length Error event packet</p> <p>Section 4.2.5.1.16: Added new event for TC counter error</p> <p>Section 4.2.21.1.3: Modified SMEC Block to contain full frame. This Is doen to be consistant with the use of selected data for SMEC operations</p> <p>Section 4.2.21.1.6: Defined DPU Blocks</p> <p>Section 4.2.21.2.6: Defined Selected Data Block, including adding normal SMEC data block</p> <p>Section 4.2.21.3.11: Added Transparent Data Block definition</p> <p>Section 4.2.21.4: Added Housekeeping Packet Definition Report</p> <p>Section 4.2.21.4.3: Added Housekeeping Packet Definition Report Parameters</p> <p>Section 4.2.21.4.4: Added Table Report Parameters</p>
Issue 1.1 Draft 3	13 th August 2003	<p>Updated TM(8,4) section to conform to AD01 – added SID to commands</p>
Issue 1.1 Draft 4		<p>All TC Sections: Changed commands names to be identical to the short description in the MIB</p> <p>Section 3.1: Removed all service 12 TCs from table – this is handled with TC(8,4) commands</p> <p>Section 3.2.6: Added Boot S/W Memory ID = 4 for dumping and checking memory</p> <p>Section 3.2.6.1: noted maximum rate of sending Memory Load commands</p> <p>Section 3.2.8.3.4: added Garbage Collection command</p> <p>Section 3.2.8.3.7: corrected length field</p> <p>Section 3.2.8.3.9: corrected length field</p> <p>Section 3.2.8.3.11: corrected length field</p> <p>Section 3.2.8.3.13: corrected length field</p> <p>Section 3.2.8.3.14: corrected length field</p> <p>Section 3.2.8.3.15: corrected length field</p> <p>Section 3.2.8.3.16: Added possible Peak-up Mode definition</p> <p>Section 3.2.8.3.17: corrected length field</p> <p>Section 3.2.8.3.18: corrected length field</p> <p>Section 3.2.8.3.19: corrected length field</p> <p>Section 3.2.8.3.20: corrected length field</p> <p>Section 3.2.8.3.21: corrected length field</p> <p>Section 3.2.8.3.22: corrected length field</p> <p>Section 3.2.8.3.23: corrected length field</p>



		<p>Section 3.2.8.3.24: corrected length field Section 3.2.8.3.25: corrected length field Section 3.2.8.3.26: corrected length field Section 3.2.8.3.27: corrected length field Section 3.2.8.3.28: corrected length field Section 3.2.8.3.29: corrected length field Section 3.2.8.3.30: corrected length field Section 3.2.8.3.31: Corrected length field Modified explanatory text, removed SELECTID from input parameters Section 3.2.8.3.32: Corrected length field Replaced SELECTID by FRAMEID in input parameters Section 3.2.8.3.33: corrected length field Section 3.2.8.3.34: corrected length field Section 3.2.8.3.35: corrected length field Section 3.2.8.3.36: corrected length field Section 3.2.12: Defined Service 12 as Not Used Section 3.2.14.1: Defined Packet ID as the parameter to select which packets are to be enabled Section 3.2.14.2: Defined Packet ID as the parameter to select which packets are to be disabled Section 4.1: Updated table to show TM(5,4) is used, TM(12, 9) is not used and TM(22,*) is not used Section 4.2.1.6: Deleted illegal Packet error from table as it referred to Service 20 , which is no longer used Section 4.2.3.1: Updated APID for Critical Housekeeping Packet Section 4.2.3.2: Added DPUSTAT to Critical HSK Section 4.2.3.3: Added SCU25V, SCUREF and SCUGND to HSK TM packet Increased LSLOAD length to 32 bits – compensated by removing DPU Spare Renumbered table entries Various further name changes Section 4.2.5.1.5: Modified TM packet to include full response from DRCU Section 4.2.5.1.9: Modified TM packet to include full response from DRCU plus the interface status Section 4.2.5.1.10: Modified TM packet to include the interface status Section 4.2.5.1.11: Modified TM packet SID Section 4.2.5.1.19: Added Out of Limits Event Packet Section 4.2.5.3: Updated Boot SW error Packets definitions Section 4.2.8.1: Added SID to TM Packet Section 4.2.8.1: Corrected Parameter Table Section 4.2.21.4: Added DPU Science Data Packet</p>
Issue 1.2j		<p>Section 2.2: Updated APIDs Section 3.2.3: Changed Housekeeping Packet IDs Section 3.2.8.3.32: Changed description of selection command, updated command error list Section 3.2.8.3.34: Added Error codes 0x0817 – 0x0819 Section 3.2.8.3.35: Added Error code 0x0829 Section 3.2.8.3.36: Added Error code 0x0829 Section 4.2.1.2.2: Deleted Failure code 5 (not sent in TM(1,2) but in TM(1,8)) Section 4.2.1.6: Updated Error codes Section 4.2.3.2: Changed OBSVER parameter</p>



Project Document

SPIRE Data ICD

Ref: SPIRE-RAL-PRJ-001078

Issue: Issue 2.0

Date: 15th November 2004

Page: 8 of 143

		<p>Section 4.2.3.3: Updated Parameters</p> <p>Section 4.2.5.1: Made SIDs unique Updated parameter names</p> <p>Section 4.2.5.2.1: Changed SID from 0x0520 to 0x5200</p> <p>Section 4.2.8.3: Introduced SELSID parameter and indicated that the parameters are repeated for each Frame type</p>
Issue 1.2k		<p>Section 3.2.8.3.37: Added FORCE_WRONG_CRC command</p> <p>Section 4.2.3.3: Added 5 lost TC/TM packets counters to nominal housekeeping packet</p>
Issue 2.0		<p>Section 3.2.8.3.34: Removed Monitor Table ID</p> <p>Section 4.2.3.2: Updated table according to new version of RD07</p> <p>Section 4.2.3.2: Updated table according to new version of RD07</p> <p>Section 4.2.21.1: Removed DPU Scienc Packet - now defined as a VM science packet (see 4.2.21.4)</p> <p>Section 4.2.21.1: Added Selected Data packets to table and defined them in 4.2.21.1.6-8</p> <p>Section 4.2.21.2: Removed selected data packets (now in section 4.2.21.1)</p> <p>Section 4.2.21.1.3: Updated SMEC Science Packet contents</p> <p>Section 4.2.21.1.4: Updated BSM Science Packet contents</p> <p>Section 4.2.21.2.6.1: Updated SMEC Selected Science Packet Contents</p> <p>Section 4.2.21.3.8: Updated MCU Engineering TM Packet contents</p> <p>Section 4.2.21.3.9: Updated MCU Test Pattern TM Packet Contents</p>



TABLE OF CONTENTS

- 1. INTRODUCTION..... 13**
 - 1.1 SCOPE..... 13
 - 1.2 STRUCTURE OF THE DOCUMENT 13
 - 1.3 DOCUMENTS..... 14
 - 1.3.1 *Applicable Documents*..... 14
 - 1.3.2 *Reference Documents*..... 14
- 2. THE PACKET INTERFACE 15**
 - 2.1 PACKET STRUCTURES 15
 - 2.1.1 *Fields*..... 15
 - 2.1.2 *Telecommand Packets*..... 15
 - 2.1.3 *Telemetry Packets*..... 16
 - 2.2 APIDS..... 16
 - 2.3 PACKET TRANSFER PROTOCOL..... 16
- 3. SPIRE TELECOMMAND PACKETS..... 18**
 - 3.1 TELECOMMAND PACKET TYPES 18
 - 3.2 TELECOMMAND PACKET DEFINITION..... 19
 - 3.2.1 *Telecommand Verification Service*..... 19
 - 3.2.2 *Device Command Distribution*..... 19
 - 3.2.3 *Housekeeping and Diagnostic Data Reporting*..... 19
 - 3.2.3.1 Define New Housekeeping Parameter Report (Service 3,1)..... 19
 - 3.2.3.2 Define New Diagnostic Parameter Report (Service 3,2) 19
 - 3.2.3.3 Clear Housekeeping Parameter Report Definitions (Service 3,3) 19
 - 3.2.3.4 Clear Diagnostic Parameter Report Definitions (Service 3,4)..... 19
 - 3.2.3.5 Report Housekeeping Parameter Report Definitions (Service 3,9) 19
 - 3.2.3.6 Report Diagnostic Parameter Report Definitions (Service 3,11) 19
 - 3.2.4..... 20
 - 3.2.5 *Event Reporting*..... 20
 - 3.2.6 *Memory Management*..... 21
 - 3.2.6.1 Load Memory Using Absolute Addresses (Service 6,2): LOAD_MEMORY..... 21
 - 3.2.6.2 Dump Memory Using Absolute Addresses (Service 6,5): DUMP_MEMORY 22
 - 3.2.6.3 Check Memory Using Absolute Addresses (Service 6,9): CHECK_MEMORY..... 22
 - 3.2.7..... 23
 - 3.2.8 *Function Management*..... 24
 - 3.2.8.1 Start Function (Service 8,1) 24
 - 3.2.8.2 Stop Function (Service 8,2)..... 26
 - 3.2.8.3 Perform Activity of a Function (Service 8,4)..... 28
 - 3.2.8.4 ReportFunction Status (Service 8,5) REPORT_FUNCTION..... 50
 - 3.2.9 *Time Management*..... 51
 - 3.2.9.1 Enable Time Verification (Service 9,7) ENABLE_TIME_VERIFICATION..... 51
 - 3.2.10 *Unused Service*..... 52
 - 3.2.11 *On-Board Scheduling*..... 52
 - 3.2.12 *On-Board Monitoring* 52
 - 3.2.13 *Unused Service*..... 52
 - 3.2.14 *Packet Transmission Control*..... 53
 - 3.2.14.1 Enable Generation of Telemetry Packets (Service 14,1) ENABLE_TM_GENERATION 53
 - 3.2.14.2 Disable Generation of Telemetry Packets (Service 14,2) DISABLE_TM_GENERATION.... 54
 - 3.2.14.3 Report Enabled Telemetry Packets (Service 14,3) REPORT_ENABLED_TM..... 54
 - 3.2.15 *On-Board Storage and Retrieval*..... 55
 - 3.2.16 *On-Board Traffic Management*..... 55
 - 3.2.17 *Test Service*..... 56
 - 3.2.17.1 Perform Connection Test (Service 17,1) TEST_CONNECTION 56
 - 3.2.18 *On-Board Control Procedures*..... 56



3.2.19	Action/Event Service.....	56
3.2.20	Information Distribution Service.....	57
3.2.21	Science Data.....	57
3.2.22	Context Saving Service.....	57
4.	SPIRE TELEMETRY PACKETS	58
4.1	TELEMETRY PACKET TYPES	58
4.2	TELEMETRY PACKET DEFINITIONS.....	59
4.2.1	TC Verification Service.....	59
4.2.1.1	Telecommand Acceptance Report - Success (1,1).....	59
4.2.1.2	Telecommand Acceptance Report - Failure (1,2)	59
4.2.1.3	Telecommand Execution Report - Started (1,3)	61
4.2.1.4	Telecommand Execution Report - Progress (1,5)	61
4.2.1.5	Telecommand Execution Report - Completion (1,7).....	61
4.2.1.6	Telecommand Execution Report - Failure (1,8)	62
4.2.2	Device Command Distribution.....	63
4.2.3	Housekeeping and Diagnostic Data Reporting.....	64
4.2.3.1	Housekeeping Parameter Report (Service 3,25)	64
4.2.3.2	Critical Housekeeping Report (SID=0x0300)	65
4.2.3.3	Nominal Housekeeping Report (SID=0x0301)	67
4.2.4	Unused Service.....	77
4.2.5	Event Reporting.....	77
4.2.5.1	Event Report (5,1)	77
4.2.5.2	Exception Report (5,2).....	90
4.2.5.3	Error/Alarm Report (5,4).....	92
4.2.6	Memory Management.....	96
4.2.6.1	Memory Dump, Absolute Addresses	96
4.2.6.2	Memory Check Report, Absolute Addresses	96
4.2.7	96
4.2.8	Function Management.....	97
4.2.8.1	Normal Functions Report	97
4.2.8.2	VM Functions Report.....	97
4.2.8.3	DPU Functions Report	98
4.2.9	Time Management.....	99
4.2.9.1	Time Verification Report	99
4.2.10	99
4.2.11	On Board Scheduling.....	99
4.2.12	On Board Monitoring.....	99
4.2.13	99
4.2.14	Packet Transmission Control.....	99
4.2.15	On Board Storage and Retrieval.....	100
4.2.16	On Board Traffic Management.....	100
4.2.17	Test Service.....	100
4.2.18	On Board Control Procedures.....	100
4.2.19	Action/Event Service.....	100
4.2.20	Information Distribution Service.....	100
4.2.21	Science Data.....	101
4.2.21.1	Nominal Science Data Report (21,1)	101
4.2.21.2	Science Type B Data Report (21,2)	107
4.2.21.3	Diagnostic Science Report (21,3).....	111
4.2.21.4	Auxiliary Science Data Report (21,4)	117
5.	PARAMETERS	120
5.1	TC PARAMETERS.....	120
5.1.1	Parameter Definition	120
5.1.2	Conversion Curves.....	123
5.1.3	Constraints.....	123



Project Document

SPIRE Data ICD

Ref: SPIRE-RAL-PRJ-001078
Issue: Issue 2.0
Date: 15th November 2004
Page: 11 of 143

5.2 TM PARAMETERS..... 124
 5.2.1 *Parameter Definition*.....124
 5.2.2 *Conversion Curves*.....134
 5.2.3 *Constraints*.....136

6. TABLES137

7. CONTROL LOOPS.....138
 7.1 CONTROL LOOP PARAMETERS..... 138

8. COMMAND LIST.....139

9. DETECTOR PIXEL MAPPING.....140
 9.1 PHTOMETER SW..... 140
 9.2 PHOTOMETER MW 141
 9.3 PHOTOMETER LW 142
 9.4 SPECTROMETER SW 143
 9.5 SPECTROMETER LW..... 144

FIGURES

TABLES



Glossary

APID	Application ID
CDMS	Command and Data Management System
DPU	Digital Processing Unit
OBS	On-Board Software
SID	Structure ID
SPIRE	Spectral and Photometric Imaging REceiver
SVM	Service Module
VM	Virtual Machine



1. INTRODUCTION

Control of the SPIRE instrument is handled by the Digital Processing Unit (DPU) part of the instrument electronics, which contains the On-Board Software (OBS). This unit is mounted on the spacecraft Service Module (SVM) and interfaces directly to the CDMS bus of the Herschel spacecraft for the purpose of transferring commands to, and collection of telemetry data from the instrument.

All data passing between the instrument and the spacecraft is transferred in the form of telemetry and telecommand packets conforming to the ESA packet standards (RD01 and RD02). The ESA Packet Utilisation Standard (RD03) defines the types of service that may be provided by units on board ESA spacecraft, but the set of supported packet types within the Herschel project is restricted. This restricted set is defined in the Herschel Packet Structure ICD (AD01) and is the minimum set necessary to meet the satellite operational requirements given in AD02.

Note: Items which are unclear from the documentation or are likely to be updated in the future are marked in blue text.

1.1 Scope

This document defines the packet types and their contents that will be accepted and generated by the SPIRE instrument during all operations. These packets conform to the formats given in the Packet Structure ICD (AD01) and the Ground Segment to Instruments ICD (AD03). They also provide for the instrument functionality described in the instrument Operating Modes document (RD04) and elaborated in the instrument operating document (RD04).

The document does not describe the use of the commands (to be given in the OBS User Manual) or the way in which the commands are handled by the OBS (to be found in the OBS Architectural Design document).

1.2 Structure of the Document

Section 2 describes the packet interface between the instrument and the spacecraft. This includes the general format of the packets used by the SPIRE instrument for telecommanding and telemetry (from AD01), the allocation of Application IDs used by the instrument and the functionality of the packet transfer protocol of the instrument/spacecraft interface (from AD01, appendix 9) that is used by the instrument.

Section 3 defines the format and content of each of the telecommand packets accepted by the instrument. Section 4 defines the corresponding information for the telemetry packets generated by the instrument. A description of how these packets are handled by the instrument is given in RD05.

Section 5 defines, in detail, the parameters used in the telecommand and telemetry packets.



1.3 Documents

1.3.1 Applicable Documents

- AD01 Herschel/Planck Packet Structure Interface Control Document. (SCI-PT-ICD-07527) Issue 3.0
- AD02 Herschel/Planck Operations Interface Requirements Document (SCI-PT-RS-07360), Issue 2.0 (draft3)
- AD03 Herschel Science Ground Segment to Instruments Interface Control Document (FIRST-FSC-DOC-0200), Issue 1.0
- AD04 Herschel/Planck Instrument Interface Document Part A (SCI-PT-IIDA-04624), Issue 3.0

1.3.2 Reference Documents

- RD01 Packet Telemetry Standard (ESA PSS-04-106), Issue 1, 1998
- RD02 Packet Telecommand Standard (ESA PSS-04-107), Issue 2, 1992
- RD03 Telemetry and Telecommand Packet Utilisation Standard (ECSS-E-70/41) Draft 04, April 1999
- RD04 Operating Modes of the SPIRE Instrument (SPIRE-RAL-PRJ-000320), Issue 3.0, 4th January 2002
- RD05 Operating the SPIRE Instrument (SPIRE-RAL-DOC-000768), Issue 0.4, 29th January 2002
- RD06 DRCU/DPU Interface Control Document (SAp-SPIRE-CCa-076-02) Issue 1.0, 14th February 2003
- RD07 MCU/DPU Command List Interface Control Document and User Manual (LAM/ELE/SPI/011011), Issue 4.0, 30th September 2004
- RD08 SPIRE On-Board Software User Manual (SPIRE-IFS-PRJ-001391)
- RD09 Herschel SPIRE DPU Hardware User Manual (SPIRE-IFS-PRJ-001390), Issue 1, 7th October 2002
- RD10 DPU Switch-On Procedure Telemetry Packets User Manual (DPU-MA-CGS-004), Issue: draft, 5th February 2003



2. THE PACKET INTERFACE

2.1 Packet Structures

The following packet structures are shown as a set of 16 bit words, contained in two consecutive octets in the packet structure (all packets are composed of an even number of octets). The most significant octet of each word comes before the least significant in the packet. The least significant bit of each word is on right of each field:



2.1.1 Fields

Within a field (of any length) the most significant bit is designated bit (0), the least significant bit is bit (length-1).

2.1.2 Telecommand Packets

The following figure gives the general structure of a SPIRE TC Packet (after AD01)

Packet Header	Packet ID	0	0	0	1	1	APID						
	Sequence Control	1	1	Src	Count								
	Length	Length											
Data Field	Data Field Header	0	0	0	0	Ack	1	Type					
		Sub-Type				0	0	0	0	0	0	0	0
	Source Data	DATA											
	Error Control	Checksum											

Src, Count, Length, TIME and Checksum are defined in AD01
 Ack is the most significant 3 bits of Ack as defined in AD01
 Type and Sub-Type define the packet type and are also defined in AD01



2.1.3 Telemetry Packets

The following figure gives the general structure of a SPIRE TM Packet (after AD01)

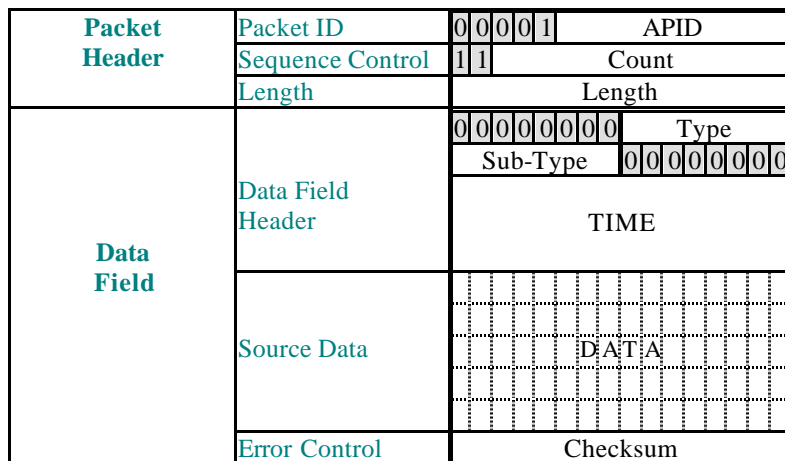

Count, Length, TIME and Checksum are defined in AD01
 Type and Sub-Type define the packet type and are also defined in AD01

Note: the TIME field contains the DPU time of the construction of the packet, not the time of collection of the data.

2.2 APIDs

The Application ID is used to identify the source or destination of a telemetry packet. Herschel uses different APIDs for different types of packet (see AD1) as well as for different instruments. The APIDS to be used by SPIRE are given in the following table:

ID	Telemetry types	APID (hex)
APID1	SPIRE Telecommands, Telecommand Verification and Events	500
APID2	SPIRE Periodic Housekeeping	502
APID3	SPIRE Photometer Science Data	504
APID4	SPIRE Spectrometer Science Data	506
APID5	SPIRE Subsystem Science Data	508

2.3 Packet Transfer Protocol

At the low-level the Packet Transfer Protocol provides a series of sub-address messages to control and transfer data between subsystems. Some of these implement the packet transfer itself, others provide alternative methods of transferring data and controlling the transfer. This section identifies the sub-addresses used/accepted by the SPIRE instrument.

Description	Sub-address(es)	Comments
Mode Command	SA 0R	Used to identify the RT addressed in this subframe. The instrument responds only to its own address. For burst mode this is only set when the instrument has indicated that it has data to transfer
	SA 0T, 31T, 31R	Not Used
Unit Control	SA 1R	Not Used
	SA 1T	Contains Subframe counter and BIT word of 1553 i/f
Data Send	SA 2T, 3T, 4T, 7T, 9T, 29T	Not Used



Project Document

SPIRE Data ICD

Ref: SPIRE-RAL-PRJ-001078
Issue: Issue 2.0
Date: 15th November 2004
Page: 17 of 143

Data Receive	SA 2R, 7R, 9R, 15R-26R, 29R	Not Used
Asynchronous Short Commands	SA 3R, 4R	Not used
Event Messages	SA 5R, 5T, 6R, 6T	Not Used
Time Messages	SA 8T	Not used
	SA 8R	Used to transfer spacecraft time from CDMU to instrument (in subframe 33) rather than use packet service (9,5)
Packet Transfer	TM Transfer Request	SA 10T Used by instrument to indicate to CDMU that a TM packet is ready to transfer
	TM Transfer Confirmation	SA 10R Used to implement retry at packet level
	TC Transfer Confirmation	SA 27T Instrument sends a copy of TC Transfer Descriptor to indicate reception of TC
	TC Transfer Descriptor	SA 27R Used by the instrument to prepare for TC transfer
TM Data Send	SA 11T-26T	Used to transfer TM packets from instrument to CDMU
TC Data Receive	SA 11R-14R	Used to transfer TC packets from CDMU to instrument
Low-level Commands	SA 28T, 28R	Not Used
Data Wrap	SA 30T, 30R	Not Used by instrument, but made available for future use



3. SPIRE TELECOMMAND PACKETS

This section defines all the telecommand packets accepted by the SPIRE instrument

3.1 Telecommand Packet Types

The Packet Structure ICD (AD1) defines many types of service that can be provided by an Application. The following table shows the telecommand packet types that will be accepted by the SPIRE instrument.

Description	Service Type	Service Sub-Type	Comments
Telecommand Verification Service	1		N/A
Device Command Distribution	2		Not Used
Housekeeping and Diagnostic Data Reporting	3		Not Used
Event Reporting	5		N/A
Memory Management			
Load Memory Using Absolute Addresses	6	2	
Dump Memory Using Absolute Addresses	6	5	
Check Memory Using Absolute Addresses	6	9	
Function Management			
Start Function	8	1	
Stop Function	8	2	
Perform Activity of Function	8	4	
Report Function Status	8	5	
Time Management			
Synchronise User	9	3	Not Used
Enable Time Synchronisation	9	4	Not Used
Time Code	9	5	Not Used
Verify User Time	9	6	Not Used
Enable Time Verification	9	7	
Synchronise Central Time Reference	9	10	Not Used
On-Board Scheduling	11		Not Used
On-Board Monitoring	12		Not Used
Packet Transmission Control			
Enable Generation of Telemetry Packets	14	1	
Disable Generation of Telemetry Packets	14	2	
Report Enabled Telemetry Packets	14	3	
On-Board Storage and Retrieval	15		Not Used
On-Board Traffic Management	16		Not Used
Test Service			
Perform Connection Test	17	1	
On-Board Control procedures	18		Not Used
Action/Event Service	19		Not Used
Information Distribution Service	20		Not Used
Science Data	21		N/A
Context Saving Service	22		TBD



3.2 Telecommand Packet Definition

3.2.1 Telecommand Verification Service

Not Applicable

3.2.2 Device Command Distribution

Not Used

3.2.3 Housekeeping and Diagnostic Data Reporting

The periodic Housekeeping and Diagnostic Data is reported, at fixed time intervals, in packets with a fixed format. A maximum of 4 different reports are available for use at the same time, each allocated a different HK_Packet_ID, in the range 0 to 3. Associated with each HK_Packet_ID is a sampling interval and an on-board table, which contains the definition of the contents of the report.

The 4 reports are defined in the following way in the OBS by default:

HK_Packet_ID	Report	Table_ID	Sampling Interval	HKSID
0x300	Critical Housekeeping Report	0	2000m sec	0x0300
0x301	Nominal Housekeeping Report	1	1000 msec	0x0301
0x302	--- Undefined ----	2	---- Not sampled ----	--- Undefined -- --
0x303	--- Undefined ----	3	---- Not sampled ----	--- Undefined---

The contents of each report are described in the Housekeeping Parameter Report (Services 3,25).

Maintenance of the housekeeping report is made using TM(8,4)

3.2.3.1 Define New Housekeeping Parameter Report (Service 3,1)

Not Used

3.2.3.2 Define New Diagnostic Parameter Report (Service 3,2)

Not Used

3.2.3.3 Clear Housekeeping Parameter Report Definitions (Service 3,3)

Not Used

3.2.3.4 Clear Diagnostic Parameter Report Definitions (Service 3,4)

Not Used

3.2.3.5 Report Housekeeping Parameter Report Definitions (Service 3,9)

Not Used

3.2.3.6 Report Diagnostic Parameter Report Definitions (Service 3,11)

Not Used



3.2.4

Not Available

3.2.5 Event Reporting

Not Applicable



3.2.6 Memory Management

These commands allow access to the contents of memory locations. Five areas of memory have been identified, with the following MEMORYID:

- 0. Program Memory (RAM)
- 1. Data memory (RAM)
- 2. 1553 I/F DPRAM
- 3. EEPROM
- 4. Boot S/W PROM

When accessing memory the address is specified in terms of the number of Single Addressable Units (SAUs) from the start of the memory area. The SPIRE SAU is always 16bit words.

Note: This packet format does not strictly follow AD01 – The MEMORYID field is 8bits and the STARTADDR field is 24 bits.

3.2.6.1 Load Memory Using Absolute Addresses (Service 6,2): LOAD_MEMORY

This command should be sent at a maximum rate of 2 per second (unless TC verification is disabled).

0	0	0	1	1	APID1
1	1	Src	Count		
Length					
0	0	0	0	Ack	1
0	0	0	0	0	0
0	0	0	0	0	1
0	0	0	0	0	0
MEMORYID					
STARTADDR					
0	0	0	0	0	0
0	0	0	0	0	0
NSAU					
Data					
CRC					
Checksum					

Parameters

Name	Comments
MEMORYID	Memory Area to be addressed Value = 0 to 3 (cannot be 4)
STARTADDR	Start Address in SAUs
NSAU	Number of SAUs to be loaded
DATA	Data to be loaded
CRC	CRC Checksum of data field

Note: The DATA field will contain the words to be written into DPU memory. 48 or 32bit words will be split into 3 or 2 16bit words and written into the DATA field of the telecommand starting from the MSB.

Possible Errors

Error	TM Service	Error Code	Description
Illegal_Memory_ID	(1,8)	0x0601	Not a valid memory ID
Illegal_Start_Address	(1,8)	0x0602	Start address outside valid range
Illegal_Nsau	(1,8)	0x0603	Length will place data outside valid address range
Bad_Nsau	(1,8)	0x0604	Length does not agree with size of data field
Bad_CRC	(1,8)	0x0605	CRC in command does not agree with calculated checksum over data in command
Bad_Load	(1,8)	0x0606	CRC in command does not agree with calculated checksum over data in memory

Note: currently there are restrictions on which memory areas can be directly loaded. These are to be clarified



3.2.6.2 Dump Memory Using Absolute Addresses (Service 6,5): DUMP_MEMORY

Note: This packet format does not strictly follow AD01 – The MEMORYID field is 8bits and the STARTADDR field is 24 bits.

0	0	0	1	1	APID1								
1	1	Src	Count										
Length = 11													
0	0	0	0	Ack	1	0	0	0	0	0	1	1	0
0	0	0	0	1	0	1	0	0	0	0	0	0	0
MEMORYID													
STARTADDR													
NSAU													
Checksum													

Parameters

Name	Value and Comments
MEMORYID	Memory Area to be addressed
STARTADDR	Start Address in SAUs
NSAU	Number of SAUs to be dumped

Possible Errors

Error	TM Service	Error Code	Description
Illegal_Memory_ID	(1,8)	0x0601	Not a valid memory ID
Illegal_Start_Address	(1,8)	0x0602	Start address outside valid range
Illegal_Nsau	(1,8)	0x0603	Length will read data outside valid address range

Note: currently there are restrictions on which memory areas can be directly dumped (for example the PROM cannot be dumped – only a copy of the PROM held in RAM). These are to be clarified

3.2.6.3 Check Memory Using Absolute Addresses (Service 6,9): CHECK_MEMORY

Note: This packet format does not strictly follow AD01 – The MEMORYID field is 8bits and the STARTADDR field is 24 bits.

0	0	0	1	1	APID1								
1	1	Src	Count										
Length = 11													
0	0	0	0	Ack	1	0	0	0	0	0	1	1	0
0	0	0	0	1	0	1	0	0	0	0	0	0	0
MEMORYID													
STARTADDR													
NSAU													
Checksum													

Parameters

Name	Value and Comments
MEMORYID	Memory Area to be addressed
STARTADDR	Start Address in SAUs
NSAU	Number of SAUs to be checked

Possible Errors

Error	TM Service	Error Code	Description
Illegal_Memory_ID	(1,8)	0x0601	Not a valid memory ID
Illegal_Start_Address	(1,8)	0x0602	Start address outside valid range
Illegal_Nsau	(1,8)	0x0603	Length will read data outside valid address range



Project Document

SPIRE Data ICD

Ref: SPIRE-RAL-PRJ-001078

Issue: Issue 2.0

Date: 15th November 2004

Page: 23 of 143

3.2.7

Not Available



3.2.8 Function Management

All command packets of this type may give rise to the following Errors:

Error	TM Service	Error Code	Description
Illegal_Function_ID	(1,2)	0x0801	Function_ID not known

3.2.8.1 Start Function (Service 8,1)

These commands allow functions that are not started automatically when the OBS runs to be started.

Possible Errors

In the event of being unable to complete the command the following reports shall be issued:

Error	TM Service	Error Code	Description
Function_Active	(1,8)	0x0830	The function is already active – command ignored

3.2.8.1.1 Function 0x01: Table Management

Always available - cannot be started

3.2.8.1.2 Function 0x02: Interrupt-driven VM

Always Available - cannot be started

3.2.8.1.3 Function 0x03: Software-driven VM1

Always Available - cannot be started

3.2.8.1.4 Function 0x04: Software-driven VM2

Always Available - cannot be started

3.2.8.1.5 Function 0x05: Software-driven VM3

Always Available - cannot be started

3.2.8.1.6 Function 0x10: ENABLE_SMEC_LATCH

This telecommand enables execution of the SMEC Launch Latch movement commands. If this function is not activated then commands to the SMEC launch latch will be rejected by the OBS.

0	0	0	1	1	APID1									
1	1	Src	Count											
Length =9														
0	0	0	0	0	0	1	0	0	0	0	1	0	0	0
0	0	0	0	0	0	1	0	0	0	0	0	0	0	
FUNCTIONID		0				0				0				
SID=0x0000														
Checksum														

Parameters

Name	Value and Comments
FUNCTIONID	0x10



3.2.8.1.7 Function 0x70: Booting

Always Available - cannot be started

3.2.8.1.8 Function 0xC0: Operations

Always Available - cannot be started

3.2.8.1.9 Function 0xC1: Observations

Always Available - cannot be started

3.2.8.1.10 Function 0xCA: DPU

Always Available - cannot be started

3.2.8.1.11 Function 0xCC: HSK

Always Available - cannot be started



3.2.8.2 Stop Function (Service 8,2)

These commands allow functions that are not started automatically when the OBS runs to be stopped

Possible Errors

In the event of being unable to complete the command the following reports shall be issued:

Error	TM Service	Error Code	Description
Function_Stopped	(1,8)	0x0831	The function is stopped – the command cannot be executed

3.2.8.2.1 Function 0x01: Table Management

Always available - cannot be stopped

3.2.8.2.2 Function 0x02: Interrupt-driven VM

Always Available - cannot be stopped

3.2.8.2.3 Function 0x03: Software-driven VM1

Always Available - cannot be stopped

3.2.8.2.4 Function 0x04: Software-driven VM2

Always Available - cannot be stopped

3.2.8.2.5 Function 0x05: Software-driven VM3

Always Available - cannot be stopped

3.2.8.2.6 Function 0x10: DISABLE_SMEC_LATCH

This telecommand disables execution of the SMEC Launch Latch movement commands. If this function is not activated then commands to the SMEC launch latch will be rejected by the OBS.

Note: normally this function is stopped automatically by execution of a Launch Latch command

0	0	0	1	1	APID1									
1	1	Src	Count											
Length =7														
0	0	0	0	0	0	1	0	0	0	0	1	0	0	0
0	0	0	0	0	0	1	0	0	0	0	0	0	0	0
FUNCTIONID		00000000												
Checksum														

Parameters

Name	Value and Comments
FUNCTIONID	0x10

3.2.8.2.7 Function 0x70: Booting

Always Available - cannot be stopped

3.2.8.2.8 Function 0xC0: Operations

Always Available - cannot be stopped

3.2.8.2.9 Function 0xC1: Observations

Always Available - cannot be stopped



3.2.8.2.10 Function 0xCA: DPU

Always Available - cannot be stopped

3.2.8.2.11 Function 0xCC: HSK

Always Available - cannot be stopped



3.2.8.3 Perform Activity of a Function (Service 8,4)

All command packets of this type and subtype may give rise to the following Errors:

Error	TM Service	Error Code	Description
Illegal_Function_ID	(1,2)	0x0801	Function_ID not known
Illegal_Activity_ID	(1,2)	0x0802	Activity_ID not known

3.2.8.3.1 Function 0x01 Table Management, Activity 0x01: SET_TABLE

This telecommand allocates space for a table. The previous space allocated to the table is lost.

00011	APID1
11 Src	Count
Length = 11	
0000000100001000010000	
00000100000000000000	
FUNCTIONID	ACTIVITYID
SID=0x0001	
TABLEID	
TABLESIZE	
Checksum	

Parameters

Name	Value and Comments
FUNCTIONID	0x01
ACTIVITYID	0x01
SID	0x0001
TABLEID	
TABLESIZE	Number of 32 bit words allocated to table

Possible Errors

This telecommand shall be expected to issue a Telecommand Execution Report - Completed, TM(1,7) on successful completion. In the event of being unable to complete the command the following reports shall be issued:

Error	TM Service	Error Code	Description
Illegal_Table_ID	(1,8)	0x0805	Not a valid table ID
Table_Space_Full	(1,8)	0x0809	Not enough space available in DPU memory to create new table



3.2.8.3.2 Function 0x01 Table Management, Activity 0x02: REPORT_TABLE

Requests telemetry packets reporting the contents of a table starting with the word at offset INDEX (32 bit words) from the start of the table and reporting COUNT words. The contents are reported in as many TM(21,4) packets as necessary to complete the request.

0	0	0	1	1	APID1									
1	1	Src	Count											
Length = 13														
0	0	0	0	0	0	1	0	0	0	0	1	0	0	0
0	0	0	0	1	0	0	0	0	0	0	0	0	0	0
FUNCTIONID		ACTIVITYID												
SID=0x0002														
TABLEID														
INDEX														
COUNT														
Checksum														

Parameter	
Name	Value and Comments
FUNCTIONID	0x01
ACTIVITYID	0x02
SID	0x0002
TABLEID	
INDEX	Starting offset to first word to report
COUNT	Number of (32 bit) words to report

Possible Errors

Error	TM Service	Error Code	Description
Illegal_Table_ID	(1,8)	0x0805	Not a valid table ID
Illegal_Table_Index	(1,8)	0x0806	Index outside valid range
Table_Bounds_Error	(1,8)	0x080d	Not enough data available in the table to report COUNT words
Undefined_Table_Error	(1,8)	0x0811	Table is not defined



3.2.8.3.3 Function 0x01 Table Management, Activity 0x03: UPDATE_TABLE

This command is used to load data into a table. The table should have had sufficient space allocated previously using the Set_Table command

0	0	0	1	1	APID1									
1	1	Src	Count											
Length														
0	0	0	0	0	0	1	0	0	0	0	1	0	0	0
0	0	0	0	1	0	0	0	0	0	0	0	0	0	0
FUNCTIONID		ACTIVITYID			SID=0x0003									
TABLEID														
INDEX														
N														
Data														
Checksum														

Parameters

Name	Value and Comments
FUNCTIONID	0x01
ACTIVITYID	0x03
SID	0x0003
TABLEID	
INDEX	Start location at which to place Data
N	Number of 32bit words to place in table
Data	N (32 bit) words to be placed in the table

Contents of the Data is dependant on the function of the table and will be specified by IFSI

Possible Errors

This telecommand shall be expected to issue a Telecommand Execution Report - Completed, TM(1,7) on successful completion. In the event of being unable to complete the command the following reports shall be issued:

Error	TM Service	Error Code	Description
Illegal_Table_ID	(1,8)	0x0805	Not a valid table ID
Illegal_Table_Index	(1,8)	0x0806	Index outside valid range
Table_Bounds_error	(1,8)	0x080d	Not enough space available in table to write new data
Bad_Data	(1,8)	0x0808	N does not agree with length of data field
Undefined_Table_Error	(1,8)	0x0811	Table is not defined



3.2.8.3.4 Function 0x01 Table Management, Activity 0x04: COLLECT_GARBAGE

This command is used to run the garbage collector.

Note: the garbage collector also runs automatically if the free contiguous space available for tables is less than 20% of the total available (To be Clarified)

0	0	0	1	1	APID1									
1	1	Src	Count											
Length=9														
0	0	0	0	0	0	1	0	0	0	0	1	0	0	0
0	0	0	0	1	0	0	0	0	0	0	0	0	0	0
FUNCTIONID		ACTIVITYID												
SID=0x0004														
Checksum														

Parameters

Name	Value and Comments
FUNCTIONID	0x01
ACTIVITYID	0x04
SID	0x0004

Possible Errors

This telecommand shall be expected to issue a Telecommand Execution Report - Completed, TM(1,7) on successful completion. In the event of being unable to complete the command the following reports shall be issued:

Error	TM Service	Error Code	Description



3.2.8.3.5 Function 0x02 Interrupt-driven VM, Activity 0x01: EXECUTE_COMMAND_LIST

Execute the command list held in the telecommand packet.

The Command list being executed is responsible for issuing all the necessary telecommand execution reports

0	0	0	1	1	APID1									
1	1	Src	Count											
Length														
0	0	0	0	0	0	1	0	0	0	0	1	0	0	0
0	0	0	0	1	0	0	0	0	0	0	0	0	0	0
FUNCTIONID					ACTIVITYID									
SID=0x0004														
N														
Data														
Checksum														

Parameters

Name	Value and Comments
FUNCTIONID	0x02
ACTIVITYID	0x01
SID	0x0004
N	Number of 32bit words in the command List
Data	N * 32 bit data words containing the command list to execute

Possible Errors

Error	TM Service	Error Code	Description
Bad_Data	(1,8)	0x0808	N does not agree with length of data field
VM_Active	(1,8)	0x080c	The VM is already executing a command list

3.2.8.3.6 Function 0x02 Interrupt-driven VM, Activity 0x02: RUN_VM

Execute a command list held in a table by the Interrupt-driven VM. If the VM is already active the telecommand is rejected with an error packet (see below).

The Command list being executed is responsible for issuing all the necessary telecommand execution reports

0	0	0	1	1	APID1									
1	1	Src	Count											
Length														
0	0	0	0	0	0	1	0	0	0	0	1	0	0	0
0	0	0	0	1	0	0	0	0	0	0	0	0	0	0
FUNCTIONID					ACTIVITYID									
SID=0x0005														
TABLEID														
INDEX														
N														
Data														
Checksum														

Parameters

Name	Value and Comments
FUNCTIONID	0x02
ACTIVITYID	0x02
SID	0x0005
TABLEID	Table_ID of list to execute
INDEX	Index within Table at which to start
N	Number of data words
Data	N * 32 bit data words. These are the parameters passed to the VM in registers R(0) to R(N-1)

Possible Errors

Error	TM Service	Error Code	Description
Illegal_Table_ID	(1,8)	0x0805	Not a valid table ID
Illegal_Table_Index	(1,8)	0x0806	Index outside valid range
Bad_Data	(1,8)	0x0808	N does not agree with length of data field
VM_Active	(1,8)	0x080c	The VM is already executing a command list



Project Document

SPIRE Data ICD

Ref: SPIRE-RAL-PRJ-001078
Issue: Issue 2.0
Date: 15th November 2004
Page: 33 of 143

VM_Undefined_Table_Error	(1,8)	0x0810	Table is not defined
--------------------------	-------	--------	----------------------

3.2.8.3.7 Function 0x02 Interrupt-driven VM, Activity 0x03: HALT_VM

0	0	0	1	1	APID1									
1	1	Src	Count											
Length = 9														
0	0	0	0	0	0	1	0	0	0	0	1	0	0	0
0	0	0	0	0	1	0	0	0	0	0	0	0	0	0
FUNCTIONID		ACTIVITYID												
SID=0x0000														
Checksum														

Parameters

Name	Value
FUNCTIONID	0x02
ACTIVITYID	0x03
SID	0x0000

Possible Errors

Error	TM Service	Error Code	Description
VM_Inactive	(1,8)	0x080a	Command List Not Running



3.2.8.3.8 Function 0x03 Software-driven VM1, Activity 0x02: RUN_VM1

Start execution of a command list held in a table by the software-driven VM1. If the VM is already active the telecommand is rejected with an error packet (see below).

The Command list being executed is responsible for issuing all the necessary telecommand execution reports

0	0	0	1	1	APID1									
1	1	Src	Count											
Length														
0	0	0	0	0	0	1	0	0	0	0	1	0	0	0
0	0	0	0	1	0	0	0	0	0	0	0	0	0	0
FUNCTIONID			ACTIVITYID			SID=0x0007								
TABLEID						INDEX								
N						Data								
Checksum														

Parameters

Name	Value and Comments
FUNCTIONID	0x03
ACTIVITYID	0x02
SID	0x0007
TABLEID	Table_ID of list to execute
INDEX	Index within Table at which to start
N	Number of data words
Data	N * 32 bit data words. These are the parameters passed to the VM in registers R(00) to R(N-1)

Possible Errors

Error	TM Service	Error Code	Description
Illegal_Table_ID	(1,8)	0x0805	Not a valid table ID
Illegal_Table_Index	(1,8)	0x0806	Index outside valid range
Bad_Data	(1,8)	0x0808	N does not agree with length of data field
VM_Active	(1,8)	0x080b	The VM is already executing a command list
Undefined_Table_Error	(1,8)	0x080d	Table is not defined

3.2.8.3.9 Function 0x03 Software-driven VM1, Activity 0x03: HALT_VM1

0	0	0	1	1	APID1									
1	1	Src	Count											
Length = 7														
0	0	0	0	0	0	1	0	0	0	0	1	0	0	0
0	0	0	0	1	0	0	0	0	0	0	0	0	0	0
FUNCTIONID			ACTIVITYID			SID=0x0000								
Checksum														

Parameters

Name	Value
FUNCTIONID	0x03
ACTIVITYID	0x03
SID	0x0000

Possible Errors

Error	TM Service	Error Code	Description
VM_Inactive	(1,8)	0x080a	VM Not Running



3.2.8.3.10 Function 0x04 Software-driven VM2, Activity 0x02: RUN_VM2

Start execution of a command list held in a table by the software-driven VM2. If the VM is already active the telecommand is rejected with an error packet (see below).

The Command list being executed is responsible for issuing all the necessary telecommand execution reports

0	0	0	1	1	APID1									
1	1	Src	Count											
Length														
0	0	0	0	0	0	1	0	0	0	0	1	0	0	0
0	0	0	0	1	0	0	0	0	0	0	0	0	0	0
FUNCTIONID			ACTIVITYID			SID=0x0009								
TABLEID						INDEX								
N						Data								
Checksum														

Parameters

Name	Value and Comments
FUNCTIONID	0x04
ACTIVITYID	0x02
SID	0x0009
TABLEID	Table_ID of list to execute
INDEX	Index within Table at which to start
N	Number of data words
Data	N * 32 bit data words. These are the parameters passed to the VM in registers R(00) to R(N-1)

Possible Errors

Error	TM Service	Error Code	Description
Illegal_Table_ID	(1,8)	0x0805	Not a valid table ID
Illegal_Table_Index	(1,8)	0x0806	Index outside valid range
Bad_Data	(1,8)	0x0808	N does not agree with length of data field
VM_Active	(1,8)	0x080b	The VM is already executing a command list
Undefined_Table_Error	(1,8)	0x080d	Table is not defined

3.2.8.3.11 Function 0x04 Software-driven VM2, Activity 0x03: HALT_VM2

0	0	0	1	1	APID1									
1	1	Src	Count											
Length = 9														
0	0	0	0	0	0	1	0	0	0	0	1	0	0	0
0	0	0	0	1	0	0	0	0	0	0	0	0	0	0
FUNCTIONID			ACTIVITYID			SID=0x0000								
Checksum														

Parameters

Name	Value
FUNCTIONID	0x04
ACTIVITYID	0x03
SID	0x0000

Possible Errors

Error	TM Service	Error Code	Description
VM_Inactive	(1,8)	0x080a	VM Not Running



3.2.8.3.12 Function 0x05 Software-driven VM3, Activity 0x02: RUN_VM3

Start execution of a command list held in a table by the software-driven VM3. If the VM is already active the telecommand is rejected with an error packet (see below).

The Command list being executed is responsible for issuing all the necessary telecommand execution reports

0	0	0	1	1	APID1									
1	1	Src	Count											
Length														
0	0	0	0	0	0	1	0	0	0	0	1	0	0	0
0	0	0	0	1	0	0	0	0	0	0	0	0	0	0
FUNCTIONID		ACTIVITYID												
SID=0x000B														
TABLEID														
INDEX														
N														
Data														
Checksum														

Parameters

Name	Value and Comments
FUNCTIONID	0x05
ACTIVITYID	0x02
SID	0x000B
TABLEID	Table_ID of list to execute
INDEX	Index within Table at which to start
N	Number of data words
Data	N * 32 bit data words. These are the parameters passed to the VM in registers R(00) to R(N-1)

Possible Errors

Error	TM Service	Error Code	Description
Illegal_Table_ID	(1,8)	0x0805	Not a valid table ID
Illegal_Table_Index	(1,8)	0x0806	Index outside valid range
Bad_Data	(1,8)	0x0808	N does not agree with length of data field
VM_Active	(1,8)	0x080b	The VM is already executing a command list
Undefined_Table_Error	(1,8)	0x080d	Table is not defined

3.2.8.3.13 Function 0x05 Software-driven VM3, Activity 0x03: HALT_VM3

0	0	0	1	1	APID1									
1	1	Src	Count											
Length = 9														
0	0	0	0	0	0	1	0	0	0	0	1	0	0	0
0	0	0	0	1	0	0	0	0	0	0	0	0	0	0
FUNCTIONID		ACTIVITYID												
SID=0x0000														
Checksum														

Parameters

Name	Value
FUNCTIONID	0x05
ACTIVITYID	0x03
SID	0x0000

Possible Errors

Error	TM Service	Error Code	Description
VM_Inactive	(1,8)	0x080a	VM Not Running



3.2.8.3.14 Function 0x10 SMEC Launch Latch, Activity 0x01: ENGAGE_LATCH

This telecommand sends the SetSLaunchLatch (engage) command (0x90430001) to the DRCU, provided the function is active. The function is then stopped.

0	0	0	1	1	APID1									
1	1	Src	Count											
Length = 9														
0	0	0	0	0	0	1	0	0	0	0	1	0	0	0
0	0	0	0	0	1	0	0	0	0	0	0	0	0	0
FUNCTIONID		ACTIVITYID												
SID=0x0000														
Checksum														

Parameters

Name	Value
FUNCTIONID	0x10
ACTIVITYID	0x01
SID	0x0000

Possible Errors

Error	TM Service	Error Code	Description
Function_Stopped	(1,8)	0x0831	The function is stopped – the command cannot be executed. An event TM(5,2) is also generated
Function_Unarmed	(5,2)	0x0832	The function has not been started prior to issuing this command

3.2.8.3.15 Function 0x10 SMEC Launch Latch, Activity 0xFF: RELEASE_LATCH

This telecommand sends the SetSLaunchLatch (disengage) command (0x90430002) to the DRCU, provided the function is active. The function is then stopped.

0	0	0	1	1	APID1									
1	1	Src	Count											
Length = 9														
0	0	0	0	0	0	1	0	0	0	0	1	0	0	0
0	0	0	0	1	0	0	0	0	0	0	0	0	0	0
FUNCTIONID		ACTIVITYID												
SID=0x0000														
Checksum														

Parameters

Name	Value
FUNCTIONID	0x10
ACTIVITYID	0xFF
SID	0x0000

Possible Errors

Error	TM Service	Error Code	Description
Function_Stopped	(1,8)	0x0831	The function is stopped – the command cannot be executed. An event TM(5,2) is also generated
Function_Unarmed	(5,2)	0x0832	The function has not been started prior to issuing this command



3.2.8.3.16 Function 0xC0 Operations, Activity 0x40: PERFORM_PEAKUP

A Peak-up Report TM(5,1) is generated as a result of this command

0	0	0	1	1						APID1						
1	1	Src								Count						
Length = 41																
0	0	0	0	0	0	0	0	1	0	0	0	0	1	0	0	0
0	0	0	0	0	1	0	0	0	0	0	0	0	0	0	0	0
FUNCTIONID		ACTIVITYID														
SID=0x000F																
DCUDATAMODE																
PIXEL																
STARTCHOPPOSN																
CHOPPOSNINCR																
NCHOPPOSNS																
STARTJIGGPOSN																
JIGGPOSNINCR																
NJIGGPOSNS																
CHOPOFFSET																
NCHOPCYCLES																
CHOPCYCLEPERIOD																
NBSMFRAMES																
BSMFRAMESTIME																
NDCUFRAMES																
DCUFRAMESTIME																
DCUFRAMESDELAY																
Checksum																

Parameters

Name	Value
FUNCTIONID	0xC0
ACTIVITYID	0x40
SID	0x000F
DCUDATAMODE	DCU Data Mode
PIXEL	Location of reference pixel in DCU Frame
STARTCHOPPOSN	Initial Chop position
CHOPPOSNINCR	Increment in Chop position
NCHOPPOSNS	Number of Chop positions
STARTJIGGPOSN	Initial Jiggle Position
JIGGPOSNINCR	Increment in Jiggle position
NJIGGPOSNS	Number of Jiggle positions
CHOPOFFSET	Offset from on-source position to off-source
NCHOPCYCLES	Number of Chop cycles
CHOPCYCLEPERIOD	Period of the Chop cycle
NBSMFRAMES	Number of BSM frames per Chop position
BSMFRAMESTIME	Time between BSM frames
NDCUFRAMES	Number of DCU frames per Chop position
DCUFRAMESTIME	Time between DCU frames
DCUFRAMESDELAY	Delay to first DCU frame

Possible Errors

Error	TM Service	Error Code	Description
No_Peak	(1,8)	0x080c	Unable to find Peak



3.2.8.3.17 Function 0xC1 Observations, Activity 0x01: SET_OBSID

Set the observation ID, and set the Building Block ID to zero. The value of these two parameters is reported in the instrument housekeeping packets and all science data packets.

0	0	0	1	1	APID1									
1	1	Src	Count											
Length = 13														
0	0	0	0	0	0	1	0	0	0	0	1	0	0	0
0	0	0	0	0	1	0	0	0	0	0	0	0	0	0
FUNCTIONID		ACTIVITYID												
SID=0x0010														
OBSID														
Checksum														

Parameters

Name	Value and Comments
FUNCTIONID	0xC1
ACTIVITYID	0x01
SID	0x0010
OBSID	Observation ID (32 bits)

3.2.8.3.18 Function 0xC1 Observations, Activity 0x02: SET_BBID

Set the Building Block ID. This is reported in the instrument housekeeping packets and all science data packets.

0	0	0	1	1	APID1									
1	1	Src	Count											
Length = 13														
0	0	0	0	0	0	1	0	0	0	0	1	0	0	0
0	0	0	0	1	0	0	0	0	0	0	0	0	0	0
FUNCTIONID		ACTIVITYID												
SID=0x0011														
BBID														
Checksum														

Parameters

Name	Value and Comments
FUNCTIONID	0xC1
ACTIVITYID	0x02
SID	0x0011
BBID	Building Block ID (32 bits)



3.2.8.3.19 Function 0xC1 Observations, Activity 0x03: SET_OBS_MODE

This value may be set by the command system in order to notify processing software of the observing mode. It is reported in the housekeeping packets. [A New Step Report event packet TM\(5,1\) is issued as a result of this command.](#)

0	0	0	1	1	APID1									
1	1	Src	Count											
Length = 11														
0	0	0	0	0	0	1	0	0	0	0	1	0	0	0
0	0	0	0	1	0	0	0	0	0	0	0	0	0	0
FUNCTIONID		ACTIVITYID												
SID=0x0012														
MODE														
Checksum														

Parameters

Name	Value and Comments
FUNCTIONID	0xC1
ACTIVITYID	0x03
SID	0x0012
MODE	Observing Mode

3.2.8.3.20 Function 0xC1 Observations, Activity 0x04: SET_OBS_STEP

This value may be set by the command system in order to notify processing software of the current step in the observing mode. It is reported in the housekeeping packets. [A New Step Report event packet TM\(5,1\) is issued as a result of this command.](#)

0	0	0	1	1	APID1									
1	1	Src	Count											
Length = 11														
0	0	0	0	0	0	1	0	0	0	0	1	0	0	0
0	0	0	0	1	0	0	0	0	0	0	0	0	0	0
FUNCTIONID		ACTIVITYID												
SID=0x0013														
STEP														
Checksum														

Parameters

Name	Value and Comments
FUNCTIONID	0xC1
ACTIVITYID	0x04
SID	0x0013
STEP	Observation Step



3.2.8.3.21 Function 0xCA DPU, Activity 0x01: RESET_DRCU_COUNTERS

This telecommand sends a broadcast command to the DRCU to reset the time counters in the DCU, SCU and MCU interfaces

0	0	0	1	1	APID1									
1	1	Src	Count											
Length = 9														
0	0	0	0	0	0	1	0	0	0	0	1	0	0	0
0	0	0	0	0	1	0	0	0	0	0	0	0	0	0
FUNCTIONID		ACTIVITYID												
SID=0x0000														
Checksum														

Parameters

Name	Value
FUNCTIONID	0xCA
ACTIVITYID	0x01
SID	0x0000

This telecommand shall be expected to issue a Telecommand Execution Report - Completed, TM(1,7) on successful completion.

3.2.8.3.22 Function 0xCA DPU, Activity 0x02: FLUSH_FIFO

This telecommand forces the DPU to read any remaining science data from the FIFOs place them into science data packets and transmit the packets. I.e. it completely empties the DPU of science data.

0	0	0	1	1	APID1									
1	1	Src	Count											
Length = 11														
0	0	0	0	0	0	1	0	0	0	0	1	0	0	0
0	0	0	0	0	1	0	0	0	0	0	0	0	0	0
FUNCTIONID		ACTIVITYID												
SID=0x0015														
FIFOFLAGS														
Checksum														

Parameters

Name	Value
FUNCTIONID	0xCA
ACTIVITYID	0x02
SID	0x0015
FIFOFLAGS	0x1000 flushes channel 0 (DCU) FIFO 0x2000 flushes channel 1 (MCU) FIFO 0x4000 flushes channel 2 (SCU) FIFO (values may be OR-ed to flush more than one FIFO)

Note: This command **must** not be sent if the DRCU is generating science data

This telecommand shall be expected to issue a Telecommand Execution Report - Completed, TM(1,7) on successful completion.

Possible Errors

Error	TM Service	Error Code	Description
Invalid_FIFOFLAGS	(1,8)	0x080f	Incorrect FIFOFLAGS (TBD)



3.2.8.3.23 Function 0xCA DPU, Activity 0x03: SET_TM_NOMINAL_MODE

This telecommand sets the telemetry interface to the CDMS to operate in Nominal Mode.

0	0	0	1	1	APID1										
1	1	Src	Count												
Length = 9															
0	0	0	0	0	0	0	1	0	0	0	0	1	0	0	0
0	0	0	0	0	1	0	0	0	0	0	0	0	0	0	0
FUNCTIONID		ACTIVITYID													
SID=0x0000															
Checksum															

Parameters

Name	Value
FUNCTIONID	0xCA
ACTIVITYID	0x03
SID	0x0000

This telecommand shall be expected to issue a Telecommand Execution Report - Completed, TM(1,7) on successful completion.

3.2.8.3.24 Function 0xCA DPU, Activity 0x04: SET_TM_BURST_MODE

This telecommand sets the telemetry interface to the CDMS to operate in Burst Mode.

0	0	0	1	1	APID1										
1	1	Src	Count												
Length = 9															
0	0	0	0	0	0	0	1	0	0	0	0	1	0	0	0
0	0	0	0	0	1	0	0	0	0	0	0	0	0	0	0
FUNCTIONID		ACTIVITYID													
SID=0x0000															
Checksum															

Parameters

Name	Value
FUNCTIONID	0xCA
ACTIVITYID	0x04
SID	0x0000

This telecommand shall be expected to issue a Telecommand Execution Report - Completed, TM(1,7) on successful completion.

3.2.8.3.25 Function 0xCA DPU, Activity 0x05: SEND_DRCU_COMMAND

This telecommand allows sending a single command to the DRCU.

0	0	0	1	1	APID1										
1	1	Src	Count												
Length = 13															
0	0	0	0	0	0	0	1	0	0	0	0	1	0	0	0
0	0	0	0	0	1	0	0	0	0	0	0	0	0	0	0
FUNCTIONID		ACTIVITYID													
SID=0x0018															
DRCU Command MSW															
DRCU Command LSW															
Checksum															

Parameters

Name	Value
FUNCTIONID	0xCA
ACTIVITYID	0x05
SID	0x0018
DRCU Command MSW	Most Significant Word of DRCU command
DRCU Command LSW	Least Significant Word of DRCU command

Possible Errors

Error	TM Service	Error Code	Description



LS_Transmit_Error	(1,8)	0x080e	Command was not correctly received by DRCU
-------------------	-------	--------	--

3.2.8.3.26 Function 0xCA DPU, Activity 0x06: RESET_FIFOS

This telecommand is used to reset all FIFOs. All data currently in the FIFOs is lost.

00011	APID1
11	Src Count
Length = 9	
00000001	00001000
00000100	00000000
FUNCTIONID	ACTIVITYID
SID=0x0000	
Checksum	

Parameters

Name	Value
FUNCTIONID	0xCA
ACTIVITYID	0x06
SID	0x0000

3.2.8.3.27 Function 0xCA DPU, Activity 0x07: WRITE2EEPROM

This telecommand is used to copy PM into EEPROM.

This copies the block of Program Memory to the start of the EEPROM and formats it such that the boot software can copy it back to Program Memory and start execution of it. (Confirm)

00011	APID1
11	Src Count
Length = 17	
00000001	00001000
00000100	00000000
FUNCTIONID	ACTIVITYID
SID=0x001A	
Start_Address MSW	
Start_Address LSW	
End_Address MSW	
End_Address LSW	
Checksum	

Parameters

Name	Value
FUNCTIONID	0xCA
ACTIVITYID	0x07
SID	0x001A
Start_Address	Starting address in PM (32 bits)
End_Address	End address in PM (32bits)

Possible Errors

Error	TM Service	Error Code	Description
EEPROM_Failed	(1,8)	0x0812	PM to EEPROM copy failed



3.2.8.3.28 Function 0x70 DPU, Activity 0x02: LOAD_TC_AND_BOOT

After upload of a new OBS image into Data Memory using TC(6,2) commands, it is necessary to send this command to copy the full image from DM to Program Memory and start the OBS.

[How does the program know where the image resides?????](#)

0	0	0	1	1	APID1									
1	1	Src	Count											
Length = 9														
0	0	0	0	0	0	1	0	0	0	0	1	0	0	0
0	0	0	0	0	1	0	0	0	0	0	0	0	0	0
FUNCTIONID						ACTIVITYID								
SID=0x0000														
Checksum														

Parameters

Name	Value
FUNCTIONID	0x70
ACTIVITYID	0x02
SID	0x0000

3.2.8.3.29 Function 0x70 DPU, Activity 0x03: FORCE_BOOT

This telecommand is used to copy the OBS image from EEPROM to Program Memory and jumps to the start location of the OBS causing it to start running.

[Need to be able to copy to a different address on Program Memory?](#)

0	0	0	1	1	APID1									
1	1	Src	Count											
Length = 9														
0	0	0	0	0	0	1	0	0	0	0	1	0	0	0
0	0	0	0	0	1	0	0	0	0	0	0	0	0	0
FUNCTIONID						ACTIVITYID								
SID=0x0000														
Checksum														

Parameters

Name	Value
FUNCTIONID	0x70
ACTIVITYID	0x03
SID	0x0000

3.2.8.3.30 Function 0x70 DPU, Activity 0x02: LOAD_TC_AND_WAIT

After upload of part of a new OBS image into Data Memory using TC(6,2) commands, it is necessary to send this command to copy the image from DM to Program Memory. Further uplink of OBS code may then be made in order to complete the image upload.

[How does the program know where the image resides?????](#)

0	0	0	1	1	APID1									
1	1	Src	Count											
Length = 7														
0	0	0	0	0	0	1	0	0	0	0	1	0	0	0
0	0	0	0	0	1	0	0	0	0	0	0	0	0	0
FUNCTIONID						ACTIVITYID								
SID=0x0000														
Checksum														

Parameters

Name	Value
FUNCTIONID	0x70
ACTIVITYID	???
SID	0x0000



3.2.8.331 Function 0xCA DPU, Activity 0x09: RESET_DPU

This telecommand performs a warm reset of the DPU by executing the Boot software resident in Program memory

0	0	0	1	1	APID1
1	1	Src	Count		
Length = 9					
0	0	0	0	0	0
0	0	0	0	0	1
0	0	0	0	1	0
0	0	0	0	0	0
FUNCTIONID			ACTIVITYID		
SID=0x0000					
Checksum					

Parameters

Name	Value
FUNCTIONID	0xCA
ACTIVITYID	0x09
SID	0x0000



3.2.8.3.32 Function 0xCA DPU, Activity 0x10: ENABLE_SELECTION

It may be necessary to reduce the instrument TM data rate (for example during parallel mode). [To do this each possible science data frame can have a single associated selection \(TBC\).](#)

Enable data selection from a science data frame. The DPU will use the contents of a table to define which words are extracted from the data frame into the telemetry packet (the table contains set of flags indicating the data required – 0 = not selected, 1= selected). The data is transmitted in a Selected Data Packet, TM(21,2) with the SID identifying the data structure.

0	0	0	1	1	APID1									
1	1	Src	Count											
Length = 15														
0	0	0	0	0	0	1	0	0	0	0	1	0	0	0
0	0	0	0	1	0	0	0	0	0	0	0	0	0	0
FUNCTIONID		ACTIVITYID				SID=0x001F								
FRAMEID						SELECTEDSID								
TABLEID						Checksum								

Parameters

Name	Value and Comments
FUNCTIONID	0xCA
ACTIVITYID	0x10
SID	0x001F
FRAMEID	Science frame to extract data from
SELECTEDSID	Structure ID to use for this Selected Data Packet
TABLEID	Table containing the selection

Possible Errors

Error	TM Service	Error Code	Description
Illegal_Frame_ID	(1,8)	0x0815	Not a valid frame ID
Illegal_Table_ID	(1,8)	0x0823	Not a valid table ID

3.2.8.3.33 Function 0xCA DPU, Activity 0x11: DISABLE_SELECTION

Disable selection for a science data frame. The complete data frame will now be placed into the science telemetry packets

0	0	0	1	1	APID1									
1	1	Src	Count											
Length = 11														
0	0	0	0	0	0	1	0	0	0	0	1	0	0	0
0	0	0	0	1	0	0	0	0	0	0	0	0	0	0
FUNCTIONID		ACTIVITYID				SID=0x0020								
FRAMEID						Checksum								

Parameters

Name	Value and Comments
FUNCTIONID	0xCA
ACTIVITYID	0x11
SID	0x0020
FRAMEID	Selection to be disabled

Possible Errors

Error	TM Service	Error Code	Description
Illegal_Selection_ID	(1,8)	0x0816	Not a valid Selection ID
Illegal_Frame_ID	(1,8)	0x0815	Not a valid frame ID
Undefined_Sel_Table	(1,8)	0x0817	Table ID is not defined
Invalid_Len_Sel_Table	(1,8)	0x0818	Length of Table does not match the selected Frame ID's Length
Invalid_Content_Sel_Table	(1,8)	0x819	Content of Table doesn't contain a valid Boolean value



3.2.8.3.34 Function 0xCC HSK, Activity 0x01: DEFINE_NEW_HK_REPORT

This command is used to define/redefine housekeeping reports. The following procedure is used

1. An on-board table is loaded with the definition of the report using one or more 'Update_Table' commands. The format of the table contents is given in RD08.
2. An on-board table is loaded with monitoring information
3. A 'Define New Housekeeping Parameter Report' is used to associate the table containing the report definition and the corresponding monitoring table with a HK_Packet_ID, a sampling interval (in msec) and a structure ID (SID). In this case:

0	0	0	1	1	APID1								
1	1	Src			Count								
Length = 21													
0	0	0	0	Ack	1	0	0	0	0	1	0	0	0
0	0	0	0	0	1	0	0	0	0	0	0	0	0
FUNCTIONID					ACTIVITYID								
SID=0x0021													
HKPCKTID													
HKSID													
HKINTERVAL													
HKREPEAT													
TABLEID													
Checksum													

Parameters

Name	Comments
FUNCTIONID	0xCC
ACTIVITYID	0x01
SID	0x0021
HKPCKTID	HK_Packet_ID
HKSID	
HKINTERVAL	msec
HKREPEAT	Number of HK frames per packet = 1
TABLEID	Table_ID

Note: The parameter is placed in the least significant bits of the 16

Notes:

In order to redefine a report, the report must first be 'cleared' using a 'Clear Housekeeping Parameter Report' command, which has the effect of stopping report generation in order that the table containing the definition of the report and the corresponding monitor table contents may be modified. Report generation restarts with the execution of this service.

Currently we assume that only one housekeeping report (frame) will be sent in each packet. In the event that we need more than one (e.g. to increase the efficiency of reporting critical housekeeping) HKREPEAT will be increased to specify the number of hsk frames per packet.

An on board table will contain in TBD format the information about parameters to be monitored; since monitoring is performed on parameters sampled as part of the nominal HK packet, a monitoring table_ID must be communicated to the OBS each time the HK table ID is updated. The details are TBD.

Possible Errors

Error	TM Service	Error Code	Description
Illegal_HK_Packet_ID	(1,8)	0x0821	HK_Packet_ID Out of Range
Illegal_HK_SID	(1,8)	0x0822	HK_SID MSB not 0x03
Illegal_Table_ID	(1,8)	0x0823	TABLEID is out of range of possible table numbers
Illegal_HK_Sampling Interval	(1,8)	0x0824	HK_Sampling Interval is less than the absolute limit (10, TBC)
Undefined_HK_Table	(1,8)	0x0825	Table given by TABLEID is not defined
Report_in_Use	(1,8)	0x0827	An attempt is being made to modify a report without first 'clearing' it.

3.2.8.3.35 Function 0xCC HSK, Activity 0x02: CLEAR_HK_REPORT



Project Document

SPIRE Data ICD

Ref: SPIRE-RAL-PRJ-001078
Issue: Issue 2.0
Date: 15th November 2004
Page: 48 of 143

This command is used to clear the definition of a housekeeping report. It is usually used prior to redefining the report with TM(8,4):Funct-Act CC-01 and has the affect of stopping report generation within the OBS.

This command should not be used for disabling reporting (use service (14,2) for this) as the definition of the report contents and sampling interval is lost.

0	0	0	1	1	APID1								
1	1	Src	Count										
Length = 11													
0	0	0	0	Ack	1	0	0	0	0	1	0	0	0
0	0	0	0	0	1	0	0	0	0	0	0	0	0
FUNCTIONID		ACTIVITYID											
SID=0x0022													
HKPCKTID													
Checksum													

Parameters

Name	Comments
FUNCTIONID	0xCC
ACTIVITYID	0x02
SID	0x0022
HKPCKTID	HK_Packet_ID

Note: The parameter is placed in the least significant bits of the 16 bit 'parameter' field and the most significant bits are padded with zeros.

Possible Errors

Error	TM Service	Error Code	Description
Illegal_HK_Packet_ID	(1,8)	0x0821	HK_Packet_ID Out of Range
Undefined_HK_Packet_ID	(1,8)	0x829	HK Packet ID not associated with a table

3.2.8.336 Function 0xCC HSK, Activity 0x03: REPORT_HK_REPORT

This command is used to report the definition of a housekeeping report.

The information requested by this command is reported in TM service (21,4). This contains only the information provided in the report definition telecommand. The actual definition of the report contents may be obtained by dumping the appropriate table.

0	0	0	1	1	APID1								
1	1	Src	Count										
Length = 11													
0	0	0	0	Ack	1	0	0	0	0	1	0	0	0
0	0	0	0	0	1	0	0	0	0	0	0	0	0
FUNCTIONID		ACTIVITYID											
SID=0x0023													
HKPCKTID													
Checksum													

Parameters

Name	Comments
FUNCTIONID	0xCC
ACTIVITYID	0x03
SID	0x0023
HKPCKTID	HK_Packet_ID

Note: The parameter is placed in the least significant bits of the 16 bit 'parameter' field and the most significant bits are padded with zeros.

Possible Errors

Error	TM Service	Error Code	Description
Illegal_HK_Packet_ID	(1,8)	0x0821	HK_Packet_ID Out of Range
Undefined_HK_Packet_ID	(1,8)	0x829	HK Packet ID not associated with a table

3.2.8.337 Function 0xCB HSK, Activity 0x01: FORCE_WRONG_CRC



Project Document

SPIRE Data ICD

Ref: SPIRE-RAL-PRJ-001078
Issue: Issue 2.0
Date: 15th November 2004
Page: 49 of 143

This command is used to force the OBS to generate the wrong CRC for the next TM packet

This is used for diagnostic purposes only.

0	0	0	1	1						APID1			
1	1	Src								Count			
Length = 11													
0	0	0	0	Ack	1	0	0	0	0	1	0	0	0
0	0	0	0	0	1	0	0	0	0	0	0	0	0
FUNCTIONID					ACTIVITYID								
SID=0x0001													
Checksum													

Parameters

Name	Comments
FUNCTIONID	0xCB
ACTIVITYID	0x01
SID	0x0001

Note: The parameter is placed in the least significant bits of the 16 bit 'parameter' field and the most significant bits are padded with zeros.

Possible Errors

Error	TM Service	Error Code	Description



3.2.8.4 ReportFunction Status (Service 8,5) REPORT_FUNCTION

This telecommand requests a report on the status of a function. The instrument should respond with a TM(8,6) report.

0	0	0	1	1	APID1				
1	1	Src		Count					
Length = 7									
0	0	0	0	0	0	0	1	0	
0	0	0	0	0	0	1	0	0	
0	0	0	0	0	1	0	0	0	
0	0	0	0	0	0	0	0	0	
0	0	0	0	0	0	0	0	0	
FUNCTIONID		0	0	0	0	0	0	0	
Checksum									

Parameter

Name	Comment
FUNCTIONID	Function to report on



3.2.9 Time Management

3.2.9.1 *Enable Time Verification (Service 9,7)* ENABLE_TIME_VERIFICATION

On receipt of this telecommand the instrument shall issue a Time Verification Report, TM(9,9).

0	0	0	1	1	APID1									
1	1	0	0	0	Count									
Length = 5														
0	0	0	0	Ack	1	0	0	0	0	1	0	0	1	
0	0	0	0	0	1	1	1	0	0	0	0	0	0	0
Checksum														



3.2.10 Unused Service

Not Available

3.2.11 On-Board Scheduling

Not Used

3.2.12 On-Board Monitoring

Not Used

3.2.13 Unused Service

Not Available



3.2.14 Packet Transmission Control

3.2.14.1 Enable Generation of Telemetry Packets (Service 14,1) ENABLE_TM_GENERATION

This telecommand enables the transmission of instrument telemetry packets. By default all packets are enabled for transmission when the OBS starts. This telecommand is therefore only needed to restart transmission after transmission has been disabled.

0	0	0	1	1	APID1								
1	1	Src	Count										
Length													
0	0	0	0	Ack	1	0	0	0	0	1	1	1	0
0	0	0	0	0	0	1	0	0	0	0	0	0	0
NPCKTS													
TYPE			SUBTYPE										
PACKETID													
Repeat Type, Subtype and SID NPCKTS-1 times													
Checksum													

Parameters

Name	Value and Comments
NPCKTS	Number of packets to enable
TYPE	Packet Type to enable
SUBTYPE	Packet Subtype to enable
PACKETID	Packet ID to enable

Possible Errors

Error	TM Service	Error Code	Description
Illegal_Type	(1,8)	0x0e01	Not a valid packet type for this APID
Illegal_Subtype	(1,8)	0x0e02	Not a valid subtype for packet with type TYPE
Illegal_PacketID	(1,8)	0x0e03	Not a valid Packet ID for packet with type TYPE and subtype SUBTYPE
Bad_NPCKTS	(1,8)	0x0e04	Number of packets to be enabled is not correct for telecommand length



3.2.14.2 Disable Generation of Telemetry Packets (Service 14,2) DISABLE_TM_GENERATION

This telecommand disables the transmission of instrument telemetry packets. By default all packets are enabled for transmission when the OBS starts.

Note: Disabling TM generation does not stop generation of the TM packets within the OBS. These are created and processed as normal, but the packet is not passed to the 1553 interface to be sent to the CDMU. This is necessary to ensure that Housekeeping Monitoring continues to function even if the housekeeping TM is disabled, for example. To be Confirmed

0	0	0	1	1	APID1
1	1	Src	Count		
Length					
0	0	0	0	Ack	1
1	0	0	0	0	1
1	1	1	0		
0	0	0	0	0	1
0	0	0	0	0	0
0	0	0	0	0	0
NPCKTS					
TYPE			SUBTYPE		
PACKETID					
Repeat Type, Subtype and Packet ID NPCKTS-1 times					
Checksum					

Parameters

Name	Value and Comments
NPCKTS	Number of packets to enable
TYPE	Packet Type to enable
SUBTYPE	Packet Subtype to enable
PACKETID	Packet ID to enable

Possible Errors

Error	TM Service	Error Code	Description
Illegal_Type	(1,8)	0x0E01	Not a valid packet type for this APID
Illegal_Subtype	(1,8)	0x0E02	Not a valid subtype for packet with type TYPE
Illegal_PacketID	(1,8)	0x0E03	Not a valid Packet ID for packet with type TYPE and subtype SUBTYPE
Bad_NPCKTS	(1,8)	0x0E04	Number of packets to be enabled is not correct for telecommand length

3.2.14.3 Report Enabled Telemetry Packets (Service 14,3) REPORT_ENABLED_TM

This telecommand requests a list of telemetry packet types and subtypes that are enabled for transmission. The list is reported in TM service (14,4)

0	0	0	1	1	APID1
1	1	Src	Count		
Length = 5					
0	0	0	0	Ack	1
1	0	0	0	0	1
1	1	1	0		
0	0	0	0	0	1
0	0	0	0	0	0
0	0	0	0	0	0
Checksum					

Parameters

Name	Value and Comments



3.2.15 On-Board Storage and Retrieval

Not Used

3.2.16 On-Board Traffic Management

Not Used



3.2.17 Test Service

3.2.17.1 Perform Connection Test (Service 17,1) TEST_CONNECTION

This test is used to check the End-to-End connection to the instrument. The instrument shall respond with a Successful Command Acceptance Report, TM(1,1), followed by a Link Connection Report, TM(17,2).

0	0	0	1	1	APID1									
1	1	0	0	0	Count									
Length = 5														
0	0	0	0	0	0	1	0	0	0	1	0	0	0	1
0	0	0	0	0	0	1	0	0	0	0	0	0	0	0
Checksum														

3.2.18 On-Board Control Procedures

Not Used

3.2.19 Action/Event Service

Not Used



3.2.20 Information Distribution Service

Not Used

3.2.21 Science Data

Not Applicable

3.2.22 Context Saving Service

Not Used



4. SPIRE TELEMETRY PACKETS

This section defines all the TM packets that will be produced by SPIRE.

4.1 Telemetry Packet Types

The Packet Structure ICD (AD1) defines many types of service that can be provided by an Application. The following table shows the telemetry packet types that will be produced by the SPIRE.

Description	Service Type	Service Sub-Type	Comments
Telecommand Verification Service			
Telecommand Acceptance Report - Success	1	1	
Telecommand Acceptance Report - Failure	1	2	
Telecommand Execution Report - Started	1	3	
Telecommand Execution Report - Progress	1	5	
Telecommand Execution Report - Completed	1	7	
Telecommand Execution Report - Failure	1	8	
Telecommand Contents Report	1	9	Not Used
Device Command Distribution	2		N/A
Housekeeping and Diagnostic Data Reporting			
HK Parameter Report Definitions Report	3	10	Not Used
Diagnostic Parameter Definitions Report	3	12	Not Used
Housekeeping Parameter Report	3	25	
Diagnostic Parameter Report	3	26	Not Used
Event Reporting			
Event Report	5	1	
Exception Report	5	2	
Error/Alarm Report	5	4	
Memory Management			
Memory Dump, Absolute Addresses	6	6	
Memory Check Report, Absolute Addresses	6	10	
Function Management			
Function Status Report	8	6	
Time Management			
Central Time Reference	9	8	Not Used
Time Verification Report	9	9	
On-Board Scheduling	11		Not Used
On-Board Monitoring			
Current Monitoring List Report	12	9	Not Used
Packet Transmission Control			
Enabled Telemetry Packets Report	14	4	
On-Board Storage and Retrieval	15		Not Used
Test Service			
Connection Test Report	17	2	
On-Board Control procedures	18		Not Used
Action/Event Service	19		Not Used
Information Distribution Service	20		Not Used
Science Data			
Nominal Science Data Report	21	1	
Science Type B Data Report	21	2	
Diagnostic Science Data Report	21	3	
Auxiliary Science Data Report	21	4	
Context Saving Service	22		Not Used



4.2 Telemetry Packet definitions

4.2.1 TC Verification Service

4.2.1.1 Telecommand Acceptance Report - Success (1,1)

00001	APID1
11	Count
	Length = 15
0000000000000001	
0000000010000000	
TIME	
TC_Packet_ID	
TC_Packet_Sequence_Control	
Checksum	

4.2.1.2 Telecommand Acceptance Report - Failure (1,2)

The structure of this packet depends on the type of error found.

4.2.1.2.1 Packet Control Errors

00001	APID1
11	Count
	Length
0000000000000001	
0000000010000000	
TIME	
TC_Packet_ID	
TC_Packet_Sequence_Control	
<i>Failure Code</i>	
TC_Packet_Length	
Data_Field_Header	
Data_Field_Error_Control	
<i>Parameter</i>	
Checksum	

Error	Failure Code	Parameter
Illegal APID	0	None
Incomplete Packet or invalid Length	1	Actual length of received packet
Incorrect Checksum	2	Calculated Checksum from received packet
Illegal Packet Type	3	None
Illegal Packet Sub-Type	4	None

Note: The parameter is placed in the least significant bits of the 16 bit 'parameter' field and the most significant bits are padded with zeros



4.2.1.2.2 Packet Content Error

0	0	0	0	1	APID1														
1	1	Count																	
Length=57																			
0	0	0	0	0	0	0	0	0	0	0	0	0	0	0	0	0	0	0	1
0	0	0	0	0	1	0	0	0	0	0	0	0	0	0	0	0	0	0	0
TIME																			
TC_Packet_ID																			
TC_Packet_Sequence_Control																			
Failure Code																			
Parameters																			
Checksum																			

Error	Failure Code	Parameters
Illegal Function ID	0x0801	See Note
Illegal Activity ID	0x0802	See Note

Note: The parameters field should contain the first 20 words from the 'source data' field of the received telecommand packet, unless this field is less than 20 words in length, in which case all words from the 'source data' field will be included and padded with zeros.



4.2.1.3 Telecommand Execution Report - Started (1,3)

This report is generated at the start of execution of a telecommand. It is only transmitted in telemetry if the corresponding bit of the Ack field is set.

0	0	0	0	1	APID1									
1	1	Count												
Length = 15														
0	0	0	0	0	0	0	0	0	0	0	0	0	0	1
0	0	0	0	0	1	1	0	0	0	0	0	0	0	0
TIME														
TC_Packet_ID														
TC_Packet_Sequence_Control														
Checksum														

4.2.1.4 Telecommand Execution Report - Progress (1,5)

These reports may be generated by an executing telecommand. They are only transmitted in telemetry if the corresponding bit of the Ack field is set.

0	0	0	0	1	APID1									
1	1	Count												
Length = 17														
0	0	0	0	0	0	0	0	0	0	0	0	0	0	1
0	0	0	0	1	0	1	0	0	0	0	0	0	0	0
TIME														
TC_Packet_ID														
TC_Packet_Sequence_Control														
Step_Number														
Checksum														

4.2.1.5 Telecommand Execution Report - Completion (1,7)

This report is generated at the successful completion of execution of a telecommand. It is only transmitted in telemetry if the corresponding bit of the Ack field is set.

0	0	0	0	1	APID1								
1	1	Count											
Length = 15													
0	0	0	0	0	0	0	0	0	0	0	0	0	1
0	0	0	0	1	1	1	0	0	0	0	0	0	0
TIME													
TC_Packet_ID													
TC_Packet_Sequence_Control													
Checksum													



4.2.1.6 Telecommand Execution Report - Failure (1,8)

This report is generated at the unsuccessful completion of execution of a telecommand

The structure of this packet depends on the type of error found., but follows the general form:

0 0 0 0 1	APID1
1 1	Count
Length	
0 0 0 0 0 0 0 0 0 0 0 0 0 0 0 0 1	
0 0 0 0 1 0 0 0 0 0 0 0 0 0 0 0	
TIME	
TC_Packet_ID	
TC_Packet_Sequence_Control	
Failure Code	
Parameters	
Checksum	

The following error Failure Codes have been defined with the parameters to be provided in the TM packet:

Error	Failure Code	Parameters
Illegal_Memory_ID	0x0601	Requested Memory_ID
Illegal_Start_Address	0x0602	Required Start Address
Illegal_Nsau	0x0603	Uplinked Nsau
Bad_Nsau	0x0604	Uplinked Nsau
Bad_CRC	0x0605	Uplinked CRC
Bad_Load	0x0606	Calculated Checksum
Illegal_Function_ID	0x0801	
Illegal_Activity_ID	0x0802	
Illegal_Table_ID	0x0805	Uplinked Table_ID
Illegal_Table_Index	0x0806	Uplinked Table Index
Bad_Data	0x0808	Number of 32 bit data words uplinked
Table_Space_Full	0x0809	Required Table Length
VM_Inactive	0x080A	Index of VM required to stop
VM_Active	0x080C	Index of VM required to run
Bad NData	0x080D	Uplinked number of Data Words
LS_Sync_Error	0x080E	Sync command sent
Illegal_FIFOFlags	0x080F	Uplinked FIFO flag word
VM_Undefined_Table_ID	0x0810	Table_ID
Undefined_Table	0x0811	Requested Table_ID
EEPROM_Failed	0x0812	Number of errors
Table_Busy	0x0813	Requested Table ID
Illegal_Frame_ID	0x0815	Uplinked Frame_ID



Project Document

SPIRE Data ICD

Ref: SPIRE-RAL-PRJ-001078

Issue: Issue 2.0

Date: 15th November 2004

Page: 63 of 143

Illegal_Select_ID	0x0816	Uplinked Select_ID
Undefined_Sel_Tamble	0x0817	Table ID not defined
Invalid_Len_Sel_Table	0x0818	Table size doesn't match with Frame Length
Invalid_Content_Sel_Table	0x0819	Table doesn't contain a valid Boolean array
Peak_up Error	0x0820	-----
Illegal_HK_Packet_ID	0x0821	Uplinked HK_Packet_ID
Illegal_HK_SID	0x0822	Uplinked HK_SID
Illegal_Table_ID	0x0823	Uplinked Table_ID
Illegal_HK_Sampling Interval	0x0824	Required HK_Sampling_Interval (ms)
Undefined_HK_Table	0x0825	Uplinked HK Table_ID
Undefined_Monitoring_TableID	0x0826	Uplinked Monitoring_TableID
Report_in_Use	0x0827	Uplinked HK_Packet_ID
Undefined_HK_ID	0x0829	HK Packet ID requested doesn't correspond to a currently running table
Function_Active	0x0830	Requested Function is already Active
Function_Stopped	0x0831	Requested Function is already Stopped
Illegal_Type	0x0E01	Type
Illegal_Subtype	0x0E02	Subtype
Illegal_SID	0x0E03	Packet ID
Bad_NPCKTS	0x0E04	NPCKTS

4.2.2 Device Command Distribution

Not Used



4.2.3 Housekeeping and Diagnostic Data Reporting

4.2.3.1 Housekeeping Parameter Report (Service 3,25)

The general packet structure is shown below. The Structure ID identifies the housekeeping packet type.

0	0	0	0	1	APID									
1	1	Count												
Length														
0	0	0	0	0	0	0	0	0	0	0	0	0	1	1
0	0	0	1	1	0	0	1	0	0	0	0	0	0	0
TIME														
SID														
Parameters														
Checksum														

APID	Packet type
APID1	Critical Housekeeping Report
APID2	Nominal Housekeeping Report

SID	Packet type	Default Period (msec)
0x0300	Critical Housekeeping Report	2000
0x0301	Nominal Housekeeping Report	1000



4.2.3.2 Critical Housekeeping Report (SID=0x0300)

Location (octet)	Field Offset (bits)	Field Length (bits)	Parameter Name	CMD	Ref.	Description
18	0	32	OBSID_C		AD03	Observation ID
22	0	32	BBID_C		AD03	Building Block ID
	16	16	BBTYPE_C			
26	0	16	MODE_C			Observing Mode – set by command
28	0	16	STEP_C			Observation Step – set by command
30	0	16	TCRECV_C			Count of Telecommands Received
32	0	16	TCEXEC_C			Count of Telecommands Executed
34	0	48	MEMSTAT_C			Memory Check Flags – updated by background memory checking task
40	0	16	MONSTAT_C			Status of subsystems monitoring
42	0	16	EVENTSTAT_C			Status of events
44	0	16	DCUIFSTAT_C	88000000	RD06	CmdIfStat
	0	1	DCUIFOLAPERR_C			Command Overlapped
	1	1	DCUIFBCASTERR_C			Forbidden Broadcast
	2	1	DCUIFREADERR_C			Forbidden Read
	3	1	DCUIFTOUTERR_C			SubSystem Timeout
	4	2	DCUIFCMDSTAT_C			LastCmdStatus
46	0	16	MCUIFSTAT_C	98000000	RDO6	CmdIfCtrl
	0	1	MCUIFOLAPERR_C			DataIfReset
	1	1	MCUIFBCASTERR_C			SubSystemRst
	2	1	MCUIFREADERR_C			StatusRst
	3	1	MCUIFTOUTERR_C			
	4	2	MCUIFCMDSTAT_C			
48	0	16	SCUIFSTAT_C	A8000000	RDO6	CmdIfCtrl
	0	1	SCUIFOLAPERR_C			DataIfReset
	1	1	SCUIFBCASTERR_C			SubSystemRst
	2	1	SCUIFREADERR_C			StatusRst
	3	1	SCUIFTOUTERR_C			
	4	2	SCUIFCMDSTAT_C			
50	0	16	PSWJFETSTAT_C	8C120000	RD06	
	0	1	PSWJFETPWR1_C			PSW_JFET_1
	1	1	PSWJFETPWR2_C			PSW_JFET_2
	2	1	PSWJFETPWR3_C			PSW_JFET_3
	3	1	PSWJFETPWR4_C			PSW_JFET_4
	4	1	PSWJFETPWR5_C			PSW_JFET_5
	5	1	PSWJFETPWR6_C			PSW_JFET_6
52	0	16	PMLWJFETSTAT_C	8C130000	RDO6	
	0	1	PMWJFETPWR1_C			PMW_JFET_1
	1	1	PMWJFETPWR2_C			PMW_JFET_2
	2	1	PMWJFETPWR3_C			PMW_JFET_3
	3	1	PMWJFETPWR4_C			PMW_JFET_4
	4	1	PLWJFETPWR1_C			PLW_JFET_1
	5	1	PLWJFETPWR2_C			PLW_JFET_2
	6	1	TCJFETPWR_C			TC_JFET
54	0	16	SPECJFETSTAT_C	8C370000	RD06	
	0	1	SLWJFETPWR1_C			SLW_JFET1
	1	1	SSWJFETPWR1_C			SSW_JFET1
	2	1	SSWJFETPWR2_C			SSW_JFET2



Project Document

SPIRE Data ICD

Ref: SPIRE-RAL-PRJ-001078

Issue: Issue 2.0

Date: 15th November 2004

Page: 66 of 143

Location (octet)	Field Offset (bits)	Field Length (bits)	Parameter Name	CMD	Ref.	Description
56	0	16	LIAS _{STAT_C}	8C3F0012	RD06	PWR_STATUS, LIA 1 to LIA 12
	0	1	LIA01STAT_C			LIA 1 +5V/+9V/-9V status
	1	1	LIA02STAT_C			LIA 2 +5V/+9V/-9V status
	2	1	LIA03STAT_C			LIA 3 +5V/+9V/-9V status
	3	1	LIA04STAT_C			LIA 4 +5V/+9V/-9V status
	4	1	LIA05STAT_C			LIA 5 +5V/+9V/-9V status
	5	1	LIA06STAT_C			LIA 6 +5V/+9V/-9V status
	6	1	LIA07STAT_C			LIA 7 +5V/+9V/-9V status
	7	1	LIA08STAT_C			LIA 8 +5V/+9V/-9V status
	8	1	LIA09STAT_C			LIA 9 +5V/+9V/-9V status
	9	1	LIA10STAT_C			LIA 10 +5V/+9V/-9V status
	10	1	LIA11STAT_C			LIA 11 +5V/+9V/-9V status
11	1	LIA12STAT_C	LIA 12 +5V/+9V/-9V status			
58	0	16	MCUERR_C	99E90000	RD06	ErrorCode
60	0	16	SMECSTAT_C	98600000	RD06	SMECStatus
62	0	16	BSMSTAT_C	99000000	RD06	BSMStatus
64						
66	0	16	SCUSTAT_C	A8800000	RD06	ScuStatus
68	0	16	SUBKTEMP_C	A8F00000	RD06	CEVTemp
70	0	16	<i>OBSVER_C</i>			
	0	7	'j'			SubVersion
	8	11	'2'			Version
	12	15	'I'			Issue



4.2.3.3 Nominal Housekeeping Report (SID=0x0301)

The following table lists the field to be found in this report

Location	Field Offset (bits)	Field Length (bits)	Parameter Name	CMD	Ref.	Description
18	0	32	OBSID	20010000	AD03	Observation ID
22	0	32	BBID		AD03	Building Block ID
	16	16	BBTYPE			
26	0	16	MODE	10030000		Observing Mode – set by command
28	0	16	STEP	10040000		Observation Step – set by command
30	0	48	THSK	30050000		Time of start of housekeeping collection
36	0	48	TRESET	30060000		Time of last reset command to the DRCU
42	0	16	TCRECV			Count of Telecommands Received
44	0	16	TCRECN	10080000	AD01	Packet Sequence Control, Sequence count of latest received telecommand
46	0	16	TCEXEC			Count of Telecommands Executed
48	0	16	TCEXEN	100A0000	AD01	Packet Sequence Control, Sequence count of latest executed telecommand
50	0	16	TM1N		AD01	Packet Sequence Control, Sequence count of TM Packets for APID1
52	0	16	TM2N		AD01	Packet Sequence Control, Sequence count of TM Packets for APID2
54	0	16	TM3N		AD01	Packet Sequence Control, Sequence count of TM Packets for APID3
56	0	16	TM4N		AD01	Packet Sequence Control, Sequence count of TM Packets for APID4
58	0	16	TM5N		AD01	Packet Sequence Control, Sequence count of TM Packets for APID5
60	0	16	DCUFRAMECNT			No of frames read from DCU FIFO
62	0	16	MCUFRAMECNT			No of frames read from MCU FIFO
64	0	16	SCUFRAMECNT			No of frames read from SCU FIFO
66	0	48	TSYNC			Time of last re-sync with CDMS
72	0	48	TDIFF			Difference between current DPU time and CDMS Time at last re-sync
	0	32	DIFFS			
78	0	48	MEMSTAT			Memory Check Flags – updated by background memory checking task
84	0	16	MONSTAT			Status of subsystems monitoring
86	0	16	EVENTSTAT			Status of events
88	0	16	VMSTAT			Status of VM (table ID being executed)
90	0	16	VM1STAT			Status of VM1 (table ID being executed)
92	0	16	VM2STAT			Status of VM2 (table ID being executed)
94	0	16	VM3STAT			Status of VM3 (table ID being executed)
96	0	16	TMMODE			Telemetry Mode (Normal/Burst)
98	0	16				
100	0	16				
102	0	16				
104	0	16				
106	0	16				
108	0	16				
110	0	16				
112	0	16				
114	0	16	DPUP5V	04180000	RD09	DPU monitored +5V voltage line
116	0	16	DPUP15V	04190000	RD09	DPU monitored +15V voltage line
118	0	16	DPUM15V	041A0000	RD09	DPU monitored – 15V voltage line



Project Document

SPIRE Data ICD

Ref: SPIRE-RAL-PRJ-001078

Issue: Issue 2.0

Date: 15th November 2004

Page: 68 of 143

Location	Field Offset (bits)	Field Length (bits)	Parameter Name	CMD	Ref.	Description
120	0	16	DPUTEMP	041B0000	RD09	DPU monitored temperature
122	0	16	CPULOAD	041C0000	RD09	DPU Processor Workload
124	0	32	LSLOAD		RD09	DPU LS Workload
128	0	16	DPUP2.5V		RD09	DPU monitored +2.5V Reference voltage line
130	0 0 1 1 2 3 4	16 1 1 1 1 1 2	DCUIFSTAT DCUIFOLAPERR DCUIFBCASTERR DCU IFREADERR DCUIFTOUTERR DCUIFCMDSTAT	88000000	RD06	CmdIfStat Command Overlapped Forbidden Broadcast Forbidden Read SubSystem Timeout LastCmdStatus
132	0 0 1 1 2	16 1 1 1 1	DCUIFCTRL DCUDATAIFRESET DCUSSRESET DCUIFSTATRESET	88010000	RD06	CmdIfCtrl DataIfReset SubSystemRst StatusRst
134	0	16	DCUSSDEL	88020000	RD06	Subsystem Delay
136	0	16	DCUDATAMODE	8C3C0000	RD06	DataMode
138	0	16	DCUDATAFRMS	8C3D0000	RD06	FrameCount
140	0	16	DCUDATASTAT	8C3E0000	RD06	StartFrame
142	0	16	PHOTBIASDIV	8C180000	RD06	PhotoBiasDiv
144	0	16	PHOTBIASMODE	8C000000	RD06	PhotoBiasMode
146	0	16	PHOTMCLKDIV	8C190000	RD06	PhotoMClkDiv
148	0	16	PSWBIAS	8C010000	RD06	PhotoBiasAmpl for Photo SW Channels
150	0	16	PMWBIAS	8C020000	RD06	PhotoBiasAmpl for Photo MW Channels
152	0	16	PLWBIAS	8C030000	RD06	PhotoBiasAmpl for Photo LW Channels
154	0	16	TCBIAS	8C040000	RD06	PhotoBiasAmpl for Photo TC Channels
156	0	16	PSWPHASE	8C1A0000	RD06	PhaseShift for Photo SW Channels
158	0	16	PMWPHASE	8C1B0000	RD06	PhaseShift for Photo MW Channels
160	0	16	PLWPHASE	8C1C0000	RD06	PhaseShift for Photo LW Channels
162	0	16	TCPHASE	8C1D0000	RD06	PhaseShift for Photo TCChannels
164	0 0 1 1 2 3 4 5	16 1 1 1 1 1 1 1	PSWJFETSTAT PSWJFETPWR1 PSWJFETPWR2 PSWJFETPWR3 PSWJFETPWR4 PSWJFETPWR5 PSWJFETPWR6	8C120000	RD06	PSW_JFET_1 PSW_JFET_2 PSW_JFET_3 PSW_JFET_4 PSW_JFET_5 PSW_JFET_6
166	0 0 1 1 2 3 4 5 6	16 1 1 1 1 1 1 1 1	PMLWJFETSTAT PMWJFETPWR1 PMWJFETPWR2 PMWJFETPWR3 PMWJFETPWR4 PLWJFETPWR1 PLWJFETPWR2 TCJFETPWR	8C130000	RD06	PMW_JFET_1 PMW_JFET_2 PMW_JFET_3 PMW_JFET_4 PMW_JFET_4 PLW_JFET_1 PLW_JFET_2 TC_JFET
168	0	16	PSWJFET1V	8C050000	RD06	PSW JFET Source Voltage for Channel 1
170	0	16	PSWJFET2V	8C060000	RD06	PSW JFET Source Voltage for Channel 2
172	0	16	PSWJFET3V	8C070000	RD06	PSW JFET Source Voltage for Channel 3
174	0	16	PSWJFET4V	8C080000	RD06	PSW JFET Source Voltage for Channel 4
176	0	16	PSWJFET5V	8C090000	RD06	PSW JFET Source Voltage for Channel 5
178	0	16	PSWJFET6V	8C0A0000	RD06	PSW JFET Source Voltage for Channel 6
180	0	16	PMWJFET1V	8C0B0000	RD06	PMW JFET Source Voltage for Channel 1
182	0	16	PMWJFET2V	8C0C0000	RD06	PMW JFET Source Voltage for Channel 2
184	0	16	PMWJFET3V	8C0D0000	RD06	PMW JFET Source Voltage for Channel 3



Project Document

SPIRE Data ICD

Ref: SPIRE-RAL-PRJ-001078

Issue: Issue 2.0

Date: 15th November 2004

Page: 69 of 143

Location	Field Offset (bits)	Field Length (bits)	Parameter Name	CMD	Ref.	Description
186	0	16	PMWJFET4V	8C0E0000	RD06	PMW JFET Source Voltage for Channel 4
188	0	16	PLWJFET1V	8C0F0000	RD06	PLW JFET Source Voltage for Channel 1
190	0	16	PLWJFET2V	8C100000	RD06	PLW JFET Source Voltage for Channel 2
192	0	16	PHOTHTRV	8C110000	RD06	PhotoHeaterBias
194	0	16	TCJFETV	8C140000	RD06	TC JFET Source Voltage
196	0	16	SPECBIASDIV	8C380000	RD06	SpectroBiasDiv
198	0	16	SPECBIASMODE	8C300000	RD06	SpectroBiasMode
200	0	16	SPECMCLKDIV	8C390000	RD06	SpectroMClkDiv
202	0	16	SSWBIAS	8C310000	RD06	SpectroBiasAmpl for Spectro SW Channels
204	0	16	SLWBIAS	8C320000	RD06	SpectroBiasAmpl for Spectro MW Channels
206	0	16	SSWPHASE	8C3A0000	RD06	PhaseShift for Spectro SW Channels
208	0	16	SLWPHASE	8C3B0000	RD06	PhaseShift for Spectro LW Channels
210	0 0 1 2	16 1 1 1	SPECJFETSTAT SLWJFETPWR1 SSWJFETPWR1 SSWJFETPWR2	8C370000	RD06	SLW_JFET1 SSW_JFET1 SSW_JFET2
212	0	16	SSWJFET1V	8C350000	RD06	SSW JFET Source Voltage for Channel 1
214	0	16	SSWJFET2V	8C360000	RD06	SSW JFET Source Voltage for Channel 2
216	0	16	SLWJFETV	8C340000	RD06	SLW JFET Source Voltage
218	0	16	SPECHTRV	8C330000	RD06	Spectro Heater Bias
220	0	16	TC1TEMP	8C3F001A	RD06	T/C 1
222	0	16	TC2TEMP	8C3F001C	RD06	T/C 2
224	0	16	TC3TEMP	8C3F001E	RD06	T/C 3
226	0	16	BIASP5V	8C3F000E	RD06	BIAS/DAQ_IF +5V Voltage (before post regulator)
228	0	16	BIASP9V	8C3F000F	RD06	BIAS/DAQ_IF +9V Voltage (before post regulator)
230	0	16	BIASM9V	8C3F0010	RD06	BIAS/DAQ_IF -9V Voltage (before post regulator)
232	0 0 8 12	16 7 11 15	OBSVER 'j' '2' 'I'			SubVersion Version Issue
234	0	16				
236	0	16				
238	0	16				
240	0	16				
242	0	16	PLIAP5V	8C3F0011	RD06	LIAP +5V Voltage (before post regulator)
244	0	16	PLIAP9V	8C3F0012	RD06	LIAP +9V Voltage (before post regulator)
246	0	16	PLIAM9V	8C3F0013	RD06	LIAP -9V Voltage (before post regulator)
248	0	16	SLIAP5V	8C3F0014	RD06	LIAS +5V Voltage (before post regulator)
250	0	16	SLIAP9V	8C3F0015	RD06	LIAS +9V Voltage (before post regulator)
252	0	16	SLIAM9V	8C3F0016	RD06	LIAS -9V Voltage (before post regulator)
254	0	16				
256	0	16				
258	0	16	LIAP9TEMP	8C3F0004	RD06	LIA_B1_TEMP, LIA board 1 temperature
260	0	16	LIAP8TEMP	8C3F0005	RD06	LIA_B2_TEMP, LIA board 2 temperature
262	0	16	LIAP7TEMP	8C3F0006	RD06	LIA_B3_TEMP, LIA board 3 temperature
264	0	16	LIAP6TEMP	8C3F0007	RD06	LIA_B4_TEMP, LIA board 4 temperature
266	0	16	LIAP5TEMP	8C3F0008	RD06	LIA_B5_TEMP, LIA board 5 temperature
268	0	16	LIAP4TEMP	8C3F0009	RD06	LIA_B6_TEMP, LIA board 6 temperature



Project Document

SPIRE Data ICD

Ref: SPIRE-RAL-PRJ-001078

Issue: Issue 2.0

Date: 15th November 2004

Page: 70 of 143

Location	Field Offset (bits)	Field Length (bits)	Parameter Name	CMD	Ref.	Description
270	0	16	LIAP3TEMP	8C3F000A	RD06	LIA_B7_TEMP, LIA board 7 temperature
272	0	16	LIAP2TEMP	8C3F000B	RD06	LIA_B8_TEMP, LIA board 8 temperature
274	0	16	LIAP1TEMP	8C3F000C	RD06	LIA_B9_TEMP, LIA board 9 temperature
276	0	16	LIAS1TEMP	8C3F0001	RD06	LIA_B10_TEMP, LIA board 10 temperature
278	0	16	LIAS2TEMP	8C3F0002	RD06	LIA_B11_TEMP, LIA board 11 temperature
280	0	16	LIAS3TEMP	8C3F0003	RD06	LIA_B12_TEMP, LIA board 12 temperature
282	0	16	BIASTEMP	8C3F0000	RD06	BIAS_TEMP, Bias board temperature
284	0	16	DAQTEMP	8C3F000D	RD06	DAQ_IF_TEMP, DAQ IF board temperature
286	0 4 5 6 7 8 9 10 11 12 13 14 15	16 1 1 1 1 1 1 1 1 1 1 1 1 1 1	LIASSTAT LIAS3STAT LIAS2STAT LIAS1STAT LIAP9STAT LIAP8STAT LIAP7STAT LIAP6STAT LIAP5STAT LIAP4STAT LIAP3STAT LIAP2STAT LIAP1STAT	8C3F0017	RD06	PWR_STATUS, LIA 1 to LIA 12 LIA 1 +5V/+9V/-9V status (0=OK) LIA 2 +5V/+9V/-9V status (0=OK) LIA 3 +5V/+9V/-9V status (0=OK) LIA 4 +5V/+9V/-9V status (0=OK) LIA 5 +5V/+9V/-9V status (0=OK) LIA 6 +5V/+9V/-9V status (0=OK) LIA 7 +5V/+9V/-9V status (0=OK) LIA 8 +5V/+9V/-9V status (0=OK) LIA 9 +5V/+9V/-9V status (0=OK) LIA 10 +5V/+9V/-9V status (0=OK) LIA 11 +5V/+9V/-9V status (0=OK) LIA 12 +5V/+9V/-9V status (0=OK)
288	0 0 1 1 2 3 4	16 1 1 1 1 1 2	MCUIFSTAT MCUIFOLAPERR MCUIFBCASTERR MCUIFREADERR MCUIFTOUTERR MCUIFCMDSTAT	98000000	RD06	CmdIfStat Command Overlapped Forbidden Broadcast Forbidden Read SubSystem Timeout LastCmdStatus
290	0 0 1 2	16 1 1 1	MCUIFCTRL MCUDATIFRESET MCUSSRESET MCUIFSTATRESET	98010000	RD06	CmdIfCtrl DataIfReset SubSystemRst StatusRst
292	0	16	MCUSSDEL	98020000	RD06	Subsystem Delay
294	0	16	MCUP5V	99E00000	RD07	P5V
296	0	16	MCUP14V	99E10000	RD07	P14V
298	0	16	MCUM14V	99E20000	RD07	M14V
300	0	16	MCUP15V	99E30000	RD06	P15V
302	0	16	MCUM15V	99E40000	RD06	M15V
304	0	16	MCUMACTEMP	99E50000	RD07	MACTemp
306	0	16	MCUSMECTEMP	99E60000	RD07	SMECTemp
308	0	16	MCUBSMTEMP	99E70000	RD07	BSMTemp
310						
312	0	16	MCUERR	99E90000	RD06	ErrorCode
314	0	16	MCUSCHEDCNTLSW	99EA0000	RD06	SchedCntLSW
316	0	16	MCUSCHEDCNTMSW	99EB0000	RD06	SchedCntMSW
318	0	16	MCUTM10TSAMPLE	99C00000	RD06	TP10SampFreq
320	0	16	MCUFRAMESTART	99C10000	RD07	FrameStart
322	0	16	MCUTM12TSAMPLE	99C20000	RD06	TP12SampFreq
324	0	16	MCUFRAMES	99C30000	RD07	FrameNumber



Project Document

SPIRE Data ICD

Ref: SPIRE-RAL-PRJ-001078

Issue: Issue 2.0

Date: 15th November 2004

Page: 71 of 143

Location	Field Offset (bits)	Field Length (bits)	Parameter Name	CMD	Ref.	Description
326	0	16	MCUTM14TSAMPLE	99C40000	RD06	TP14SampFreq
328	0	16	MCUTM15TSAMPLE	99C50000	RD06	TP15SampFreq
330	0	16	MCUTMSTATUS	99DF0000	RD06	TelemetryStatus
332						
334	0	16	MCUBOOTSTAT	98200000	RD06	Boot Status Register
336	0	16	MCUDLOADCONF	98210000	RD06	DownloadParam
338	0	16	MCUDLOADWORD	98220000	RD06	DownloadWord
340	0	16	MCUDLOADPC	98230000	RD06	DownloadCounter
342						
344						
346						
348						
350						
352	0	16	SMECENCPWR	98400000	RD06	SEncoderPwr
354	0	16	SMECLVDTPWR	98410000	RD06	SLVDTPwr
356						
358	0	16	SMECLATCHSTAT	98430000	RD06	SlaunchLatch (commanded latch status)
360	0	16	SMECLOOPMODE	98440000	RD06	SLoopMode
362	0	16	SCANSTART	98460000	RD06	STrajStartPos
364	0	16	SCANEND	98450000	RD06	STrajEndPos
366	0	16	SCANFSPEED	98470000	RD06	SscanFwdSpeed
368	0	16	SCANS	98480000	RD06	SscanNumber
370	0	16	SCANMODE	98490000	RD06	STrajMode
372						
374						
376	0	16	SMECKP	984A0000	RD06	SKp
378	0	16	SMECKD	984B0000	RD06	SKd
380	0	16	SMECDFILT	984C0000	RD06	SderivFilter
382	0	16	SMECKI	984D0000	RD06	SKi
384	0	16	SMECINTLIMIT	984E0000	RD06	SIntegrationLimit
386	0	16	SMECINTTHRESH	984F0000	RD06	SIntegration Threshold
388						
390	0	16	SMECRATELIMIT	98510000	RD06	SRateLimit
392	0	16	SMECDFILT2	98520000	RD06	SderivFilter2
394						
396	0	16	SMECFFGAIN	98540000	RD06	SFeedFwdGain
398	0	16	SMECFFOFFSET	98550000	RD06	SFeedFwdOffset
400	0	16	SCANRSPEED	98560000	RD06	SscanRevSpeed
402	0	16	SMECBEMFGAIN	98900000	RD06	SMotorBEMFGain
404	0	16	SMECMOTORRES	98910000	RD06	SMotorResistance
406	0	16	SMECMOTORBEMF	98920000	RD07	MotorBEMF
408	0	16	SMECRATESCALE	98930000	RD06	SRateScaleFactor
410						
412						
414						
416	0	16	SMECLVDTOFFSET	985E0000	RD06	LVDTOffset



Project Document

SPIRE Data ICD

Ref: SPIRE-RAL-PRJ-001078

Issue: Issue 2.0

Date: 15th November 2004

Page: 72 of 143

Location	Field Offset (bits)	Field Length (bits)	Parameter Name	CMD	Ref.	Description
418	0	16	SMECLVDTSCALE	985F0000	RD06	LVDTSCale
420	0	16	SMECSTAT	98600000	RD06	SMECStatus
422	0	16	SMECENCPOSN	98610000	RD06	SEncoder IncrPosition
424	0	16	SMECENC SIG1	98620000	RD06	SEncoderSignal1
426	0	16	SMECENC SIG2	98630000	RD06	SEncoderSignal2
428	0	16	SMECENC SIG3	98640000	RD06	SEncoderSignal3
430	0	16	SMECLVDTPOSN	98650000	RD06	LVDT position
432	0	16	SMECLVDTAC SIG	98660000	RD06	LVDTAC
434	0	16	SMEVLVDTDC SIG	98670000	RD06	LVDTDC
436	0	16	SMECTRAJPOSN	98680000	RD06	TrajectoryPosition
438	0	16	SMECDACVAL	98690000	RD06 RD07	SMECDACValue
440	0	16	SMECPOSNDELTA	986A0000	RD06	EncLVDTPosDelta Position difference encoder/lvdt home
442	0	16	SMECENC FINEPOSN	986B0000	RD06	EncoderFinePosition
444						
446						
448	0	16	SMECMEANSPEED	986E0000	RD06	MeanSpeed
450	0	16	SMECSCANPOSNER R	986F0000	RD06	MeanPositionError
452	0	16	SMECMOTORCURR	98700000	RD06	SMotorCurrent
454	0	16	SMECMOTORVOLT	98710000	RD07	SMotorVoltage
456						
458						
460						
462						
464						
466						
468						
470						
472						
474						
476						
478						
480						
482						
484						
486						
488						
490	0	16	CHOPSENSPWR	98C00000	RD06	CSensorPwr
492						
494	0	16	CHOPLOOPMODE	98C20000	RD06	ChopLoopMode
496	0	16	CHOPPOSN	98C30000	RD06	Chop Target Position
498						
500						
502	0	16	BSMMODE	98C60000	RD06	BSMMove
504	0	16	CHOPDERIVGAIN	98C70000	RD07	CKdNed



Project Document

SPIRE Data ICD

Ref: SPIRE-RAL-PRJ-001078

Issue: Issue 2.0

Date: 15th November 2004

Page: 73 of 143

Location	Field Offset (bits)	Field Length (bits)	Parameter Name	CMD	Ref.	Description
506	0	16	CHOPKP	98C80000	RD06	CKp
508	0	16	CHOPKD	98C90000	RD06	CKd
510	0	16	CHOPKI	98CA0000	RD06	CKi
512	0	16	CHOPINTREF	98CB0000	RD07	CIntegrationRef
514	0	16	CHOPINTLIMIT	98CC0000	RD06	CIntegLimit
516	0	16	CHOPFFGAIN	98CD0000	RD06	CFeedFwdGain
518	0	16	CHOPFFGAINLARGE	98CE0000	RD07	CFeedForward GainLarge
520	0	16	CHOPDIFFTC1	98CF0000	RD06	DiffFilterTC1
522	0	16	CHOPDIFFTC2	98D00000	RD06	DiffFilterTC2
524	0	16	CHOPRATELIMIT	98D10000	RD06	CRateLimit
526	0	16	CHOPMOTBEMFGAIN	98D20000	RD06	CMotorBEMFGain
528	0	16	CHOPMOTRES	98D30000	RD06	CMotorResistance
530	0	16	CHOPMOTIND	98D40000	RD06	CMotorInductance
532	0	16	CHOPFFGAINULIM	98D50000	RD07	CFFgainupperlimit
534	0	16	CHOPFFGAINLLIM	98D60000	RD07	CFFgainlowerlimit
536	0	16	CHOPBEMFRATEFILTER1	98D70000	RD06	CBEMFRateFilter1
538	0	16	CHOPBEMFRATEFILTER2	98D80000	RD06	CBEMFRateFilter2
540	0	16	CHOPJIGGCCOUPLE	98D9000	RD07	C2JCrosscoupling
542	0	16	BSMSTAT	99000000	RD07	BSMStatus
544						
546	0	16	CHOPPOSNERR	99020000	RD06	CMeanPosError
548	0	16	CHOPSENSSIG	99030000	RD06	CMagResSignal
550	0	16	CHOPDACVAL	99040000	RD06	CDACValue
552	0	16	CHOPMOTORCURR	99050000	RD06	CMotorCurrent
554	0	16	CHOPMOTORVOLT	99060000	RD06	CVoltage
556						
558	0	16	JIGGSENSPWR	99400000	RD06	JSensorPwr
560						
562	0	16	JIGGLOOPMODE	99420000	RD06	JigLoopMode
564	0	16	JIGGPOSN	99430000	RD06	JigTargetPos
566						
568						
570						
572	0	16	JIGGDERIVGAIN	99430000	RD07	JKdNeg
574	0	16	JIGGKP	99480000	RD06	JKp
576	0	16	JIGGKD	99490000	RD06	JKd
578	0	16	JIGGKI	994A0000	RD06	JKi
580	0	16	JIGGINTREF	994B0000	RD06	JIntegrationRef
582	0	16	JIGGINTLIMIT	994C0000	RD06	JIntegLimint
584	0	16	JIGGFFGAIN	994D0000	RD06	JFeedForwardGain



Project Document

SPIRE Data ICD

Ref: SPIRE-RAL-PRJ-001078

Issue: Issue 2.0

Date: 15th November 2004

Page: 74 of 143

Location	Field Offset (bits)	Field Length (bits)	Parameter Name	CMD	Ref.	Description
586	0	16	JIGGFFGAINLARGE	994E0000	RD07	JFeedForwardGainLarge
588	0	16	JIGG DIFFTC1	994F0000	RD06	JDiffFilterTC1
590	0	16	JIGG DIFFTC2	99500000	RD06	JdiffFilterTC2
592	0	16	JIGGRATELIMIT	99510000	RD06	JRateLimit
594	0	16	JIGGMOTBEMFGAIN	99520000	RD06	JMotorBEMFGain
596	0	16	JIGGMOTRES	99530000	RD06	JMotorResistance
598	0	16	JIGGMOTIND	99540000	RD06	JMotorInductance
600	0	16	JIGGFFGAINULIM	99550000	RD07	JFFgainupperlimit
602	0	16	JIGGFFGAINLLIM	99560000	RD07	JFFgainlowerlimitr
604	0	16	JIGG BEMFRATEFIL1	99570000	RD06	JBEMFRateFilter1
606	0	16	JIGG BEMFRATEFIL2	99580000	RD06	JBENFRateFilter2
608	0	16	JIGGCHOPCOUPLE	99590000	RD07	J2CCrosscoupling
612						
614	0	16	JIGGPOSERR	99820000	RD06	JMeanPosError
616	0	16	JIGGSENSSIG	99830000	RD06	JMagREsSignal
618	0	16	JIGGDACVAL	99840000	RD06	JDACValue
620	0	16	JIGGMOTORCURR	99850000	RD06	JMotorCurrent
622	0	16	JIGGMOTORVOLT	99860000	RD07	JVoltage
624	0	16	MCUPCKT10PARAM05	99C60000	RD07	Pack10Param5
626	0	16	MCUPCKT10PARAM01	99C70000	RD06	Pack10Param1
628	0	16	MCUPCKT10PARAM02	99C80000	RD06	Pack10Param2
630	0	16	MCUPCKT10PARAM03	99C90000	RD06	Pack10Param3
632	0	16	MCUPCKT10PARAM04	99CA0000	RD06	Pack10Param4
634	0	16	MCUPCKT12PARAM01	99CB0000	RD06	Pack12Param1
636	0	16	MCUPCKT12PARAM02	99CC0000	RD06	Pack12Param2
638	0	16	MCUPCKT12PARAM03	99CD0000	RD06	Pack12Param3
640	0	16	MCUPCKT12PARAM04	99CE0000	RD06	Pack12Param4
642	0	16	MCUPCKT12PARAM05	99CF0000	RD06	Pack12Param5
644	0	16	MCUPCKT12PARAM06	99D00000	RD06	Pack12Param6
646	0	16	MCUPCKT14PARAM01	99D10000	RD06	Pack14Param1
648	0	16	MCUPCKT14PARAM02	99D20000	RD06	Pack14Param2
650	0	16	MCUPCKT14PARAM03	99D30000	RD06	Pack14Param3
652	0	16	MCUPCKT14PARAM04	99D40000	RD06	Pack14Param4
654	0	16	MCUPCKT14PARAM05	99D50000	RD06	Pack14Param5
656	0	16	MCUPCKT14PARAM06	99D60000	RD06	Pack14Param6
658	0	16	MCUPCKT14PARAM07	99D70000	RD06	Pack14Param7
660	0	16	MCUPCKT14PARAM08	99D80000	RD06	Pack14Param8
662	0	16	MCUPCKT14PARAM09	99D90000	RD06	Pack14Param9
664	0	16	MCUPCKT14PARAM10	99DA0000	RD06	Pack14Param10
666	0	16	MCUPCKT14PARAM11	99DB0000	RD06	Pack14Param11
668	0	16	MCUPCKT14PARAM12	99DC0000	RD06	Pack14Param12
670	0	16	MCUPCKT14PARAM13	99DD0000	RD06	Pack14Param13



Project Document

SPIRE Data ICD

Ref: SPIRE-RAL-PRJ-001078

Issue: Issue 2.0

Date: 15th November 2004

Page: 75 of 143

Location	Field Offset (bits)	Field Length (bits)	Parameter Name	CMD	Ref.	Description
672	0	16	MCUPCKT14PARAM14	99DE0000	RD06	Pack14Param14
674	0	16				
676	0 0 1 2 3 4	16 1 1 1 1 2	SCUIFSTAT SCUIFOLAPERR SCUIFBCASTERR SCUIFREADERR SCUIFTOUTERR SCUIFCMDSTAT	A8000000	RD06	CmdIfStat Command Overlapped Forbidden Broadcast Forbidden Read SubSystem Timeout LastCmdStatus
678	0 0 1 2	16 1 1 1	SCUIFCTRL SCUDATIFRESET SCUSSRESET SCUIFSTATRESET	A8010000	RD06	CmdIfCtrl DataIfReset SubSystemRst StatusRst
680	0	16	SCUSSDEL	A8020000	RD06	Subsystem Delay
682	0	16	SCUSTAT	A8800000	RD06	ScuStatus
684	0	16	SCUTEMPSTAT	A8850000	RD06	TempOnOff
686	0	16	SCUDCDCSTAT	A8870000	RD06	DRelOnOff
688	0	16	SCUP5V	A8D00000	RD06	ScuCHTp05
690	0	16	SCUP9V	A8CF0000	RD06	ScuCHTp09
692	0	16	SCUM9V	A8CE0000	RD06	ScuCHTn09
694	0	16	SPHSV	A8C50000	RD06	SPHSHeatB
696	0	16	EVHSV	A8C40000	RD06	EVHSHeatB
698	0	16	TCHTRV	A8C60000	RD06	TCHeaterB
700	0	16	SPHTRV	A8C70000	RD06	SPHeaterB
702	0	16	CCUTEMP	A8C00000	RD06	CsuTempRd
704	0	16	TCUTEMP	A8C10000	RD06	TsuTempRd
706	0	16	PSUTEMP1	A8C20000	RD06	PsuTmp1Rd
708	0 0 15	16 8 1	SCUFRAMECONF SCUFRAMERATE SCUFRAMETYPE	A8830000	RD06 RD06	FrameConf FrameRate
710	0	16	SCUFRAMES	A8840000	RD06	SeqLength
712	0	16	SCUFRAMESTAT	A8820000	RD06	FrameCtrl
714	0	16	SCUCTRL	A8810000	RD06	ScuContrl
716	0	16	PCALV	A8C90000	RD06	PhCalVolt
718	0	16	SCAL2V	A8CB0000	RD06	Sca2Volt
720	0	16	SCAL4V	A8CD0000	RD06	Sca4Volt
722	0	16	SCUCHT2.5V	A8D10000	RD06	ScuCHT25
724	0	16	SCUCHTREF	A8D20000	RD06	ScuCHTRef
726	0	16	SCUCHTGND	A8D30000	RD06	ScuCHTGnd
728	0	16	PCALCURR	A8C80000	RD06	PhCalBias
730	0	16	SCAL2CURR	A8CA0000	RD06	Sca2Bias
732	0	16	SCAL4CURR	A8CC0000	RD06	Sca4Bias
734	0	16	PSUTEMP2	A8C30000	RD06	PsuTmp2Rd
736	0	16	SUBKSTAT	A8860000	RD06	SubKpOnOff
738						
740						
742	0	16	PUMPHTRTEMP	A8E00000	RD06	CPHTemp
744	0	16	PUMPHSTEMP	A8E10000	RD06	CPHStemp
746	0	16	EVAPHSTEMP	A8E20000	RD06	CEHStemp
748	0	16	SHUNTTEMP	A8E30000	RD06	CSHTtemp
750	0	16	SOBTEMP	A8E40000	RD06	SOBtemp
752	0	16	SL0TEMP	A8E50000	RD06	SL0temp
754	0	16	PL0TEMP	A8E60000	RD06	PL0temp
756	0	16	OPTTEMP	A8E70000	RD06	SUBtemp



Project Document

SPIRE Data ICD

Ref: SPIRE-RAL-PRJ-001078

Issue: Issue 2.0

Date: 15th November 2004

Page: 76 of 143

Location	Field Offset (bits)	Field Length (bits)	Parameter Name	CMD	Ref.	Description
758	0	16	BAFTEMP	A8E80000	RD06	BAFtemp
760	0	16	BSMIFTEMP	A8E90000	RD06	BSMtemp
762	0	16	SCAL2TEMP	A8EA0000	RD06	SCL2temp
764	0	16	SCAL4TEMP	A8EB0000	RD06	SCL4temp
766	0	16	SCALTEMP	A8EC0000	RD06	SCSTtemp
768	0	16	SMECIFTEMP	A8ED0000	RD06	FTSStemp
770	0	16	SMECTEMP	A8EE0000	RD06	FTSMtemp
772	0	16	BSMTEMP	A8EF0000	RD06	BSMMtemp
774	0	16	SUBKTEMP	A8F00000	RD06	CEVTemp
776	0	16	SCUTHTREF	A8F10000	RD06	ScuTHTRef
778	0	16	SCUTHTGND	A8F20000	RD06	ScuTHTGnd
780	0	16	LOSTTCBLOCK			
782	0	16	LOSTVEBLOCK			
784	0	16	LOSTHKBLOCK			
786	0	16	LOSTSDBLOCK			
788	0	16	LOSTNTBLOCK			



4.2.4 Unused Service

Not Available

4.2.5 Event Reporting

4.2.5.1 Event Report (5,1)

These reports provide information on events in the instrument which may impact on the scientific results, but which should have no impact on the health and safety of the instrument. These will include the reporting of anomalies which have been dealt with by the DPU

4.2.5.1.1 New Step Report

Indicates a new step in the current operation Mode. This event is issued every time the MODE or STEP Number is changed

0	0	0	0	1	APID1									
1	1	Count												
Length = 29														
0	0	0	0	0	0	0	0	0	0	0	0	1	0	1
0	0	0	0	0	0	1	0	0	0	0	0	0	0	0
TIME														
EVENTID_NSR = 0x0501														
SID_NSR = 0x5100														
OBSID_NSR														
BBID_NSR														
EVENTCOUNT_NSR														
MODE_NSR														
STEP_NSR														
Checksum														

Parameter	Comment
EVENTID_NSR	0x0501
SID_NSR	0x5100
OBSID_NSR	Observation ID
BBID_NSR	Building Block ID
EVENTCOUNT_NSR	Sequential counter for TM(5,1) events
MODE_NSR	Current Mode
STEP_NSR	Step Number



4.2.5.1.2 Peak Up Report

This report is issued at the end of a peak up operation

0	0	0	0	1	APID1								
1	1	Count											
Length =31													
0	0	0	0	0	0	0	0	0	0	0	1	0	1
0	0	0	0	0	0	1	0	0	0	0	0	0	0
TIME													
EVENTID_PUR = 0x0504													
SID_PUR = 0x5101													
OBSID_PUR													
BBID_PUR													
EVENTCOUNT_PUR													
INSTRID_PUR													
THETAY_PUR													
THETAZ_PUR													
Checksum													

Parameter	Comment
EVENTID_PUR	0x0504
SID_PUR	0x5101
OBSID_PUR	Observation ID
BBID_PUR	Building Block ID
EVENTCOUNT_PUR	Sequential counter for TM(5,1) events
INSTRID_PUR	Instrument ID = 0x0002
THETAY_PUR	Rotation angle about Y axis
THETAZ_PUR	Rotation angle about Z axis



4.2.5.1.3 Unallocated Block Report

The OBS failed to allocate a memory block from the VIRTUOSO Memory Pools

0	0	0	0	1	APID1											
1	1	Count														
Length = 37																
0	0	0	0	0	0	0	0	0	0	0	0	0	0	1	0	1
0	0	0	0	0	0	1	0	0	0	0	0	0	0	0	0	0
TIME																
EVENTID_UBR = 0x0505																
SID_UBR = 0x5102																
OBSID_UBR																
BBID_UBR																
EVENTCOUNT_UBR																
POOLID_UBR																
SIZE_UBR																
ALLOC_RESULT_UBR																
TASKID_UBR																
NPKT_UBR																
MAXPKT_UBR																
Checksum																

Parameter	Comment
EVENTID_UBR	0x0505
SID_UBR	0x5102
OBSID_UBR	Observation ID
BBID_UBR	Building Block ID
EVENTCOUNT_UBR	Sequential counter for TM(5,1) events
POOLID_UBR	ID of the VIRTUOSO Pool which failed to allocate block. IDs are defined in RD08
SIZE_UBR	Size in Bytes of the requested memory block
ALLOC_RESULT_UBR	Allocation Result: <ol style="list-style-type: none"> 1. Allocation Failed 2. Allocation Timed out
TASKID_UBR	ID of the OBS task where failure occurred. IDs are defined in RD08
NPKT_UBR	Number of packets currently present in pool
MAXPKT_UBR	Maximum number of packets in pool



4.2.5.1.4 Unknown Command Report

In response to a command the DRCU indicated that the Command ID was not known

0	0	0	0	1	APID1										
1	1	Count													
Length = 33															
0	0	0	0	0	0	0	0	0	0	0	0	0	1	0	1
0	0	0	0	0	0	0	1	0	0	0	0	0	0	0	0
TIME															
EVENTID_UCR = 0x0509															
SID_UCR = 0x5103															
OBSID_UCR															
BBID_UCR															
EVENTCOUNT_UCR															
COMMAND_UCR															
ACK_UCR															
Checksum															

Parameter	Comment
EVENTID_UCR	0x0509
SID_UCR	0x5103
OBSID_UCR	Observation ID
BBID_UCR	Building Block ID
EVENTCOUNT_UCR	Sequential counter for TM(5,1) events
COMMAND_UCR	copy of command sent to DRCU (32 bits)
ACK_UCR	Echo of command most significant word received by the DPU (32bits)

4.2.5.1.5 Forbidden Command Report

In response to a command the DRCU indicated that the Command ID was forbidden

0	0	0	0	1	APID1										
1	1	Count													
Length = 33															
0	0	0	0	0	0	0	0	0	0	0	0	0	1	0	1
0	0	0	0	0	0	0	1	0	0	0	0	0	0	0	0
TIME															
EVENTID_FCR = 0x050A															
SID_FCR = 0x5104															
OBSID_FCR															
BBID_FCR															
EVENTCOUNT_FCR															
COMMAND_FCR															
RESPONSE_FCR															
Checksum															

Parameter	Comment
EVENTID_FCR	0x050A
SID_FCR	0x5104
OBSID_FCR	Observation ID
BBID_FCR	Building Block ID
EVENTCOUNT_FCR	Sequential counter for TM(5,1) events
COMMAND_FCR	copy of command sent to DRCU (32 bits)
RESPONSE_FCR	Copy of command echo returned by DRCU (32bits)



4.2.5.1.6 Frame ID Error

When copying data frames from the FIFO to the internal science data buffer, the frame ID is not correct. (The DPU should also execute a procedure to resynchronise with the science data in the FIFO).

0	0	0	0	1	APID1										
1	1	Count													
Length = 29															
0	0	0	0	0	0	0	0	0	0	0	0	0	1	0	1
0	0	0	0	0	0	1	0	0	0	0	0	0	0	0	0
TIME															
EVENTID_FIE = 0x0506															
SID_FIE = 0x5105															
OBSID_FIE															
BBID_FIE															
EVENTCOUNT_FIE															
FRAMEID_FIE															
FIFOID_FIE															
Checksum															

Parameter	Comment
EVENTID_FIE	0x0506
SID_FIE	0x5105
OBSID_FIE	Observation ID
BBID_FIE	Building Block ID
EVENTCOUNT_FIE	Sequential counter for TM(5,1) events
FRAMEID_FIE	The Frame ID received from the DRCU
FIFOID_FIE	The ID of the FIFO where the frame has been received

4.2.5.1.7 Frame Length Error

When copying data frames from the FIFO to the internal science data buffer, the frame length is not correct (RD06).

0	0	0	0	1	APID1										
1	1	Count													
Length = 31															
0	0	0	0	0	0	0	0	0	0	0	0	0	1	0	1
0	0	0	0	0	0	1	0	0	0	0	0	0	0	0	0
TIME															
EVENTID_FLE = 0x0507															
SID_FLE = 0x5106															
OBSID_FLE															
BBID_FLE															
EVENTCOUNT_FLE															
FRAMEID_FLE															
LENGTHRD_FLE															
LENGTHEX_FLE															
Checksum															

Parameter	Comment
EVENTID_FLE	0x0507
SID_FLE	0x5106
OBSID_FLE	Observation ID
BBID_FLE	Building Block ID
EVENTCOUNT_FLE	Sequential counter for TM(5,1) events
FRAMEID_FLE	The Frame ID received from the DRCU
LENGTHRD_FLE	Frame length as read from the DRCU frame
LENGTHEX_FLE	Expected frame length for that frame ID



4.2.5.1.8 Frame Checksum Error

When copying data frames from the FIFO to the internal science data buffer, the Checksum word at the end of the frame is not correct.

0	0	0	0	1	APID1											
1	1	Count														
Length = 31																
0	0	0	0	0	0	0	0	0	0	0	0	0	0	1	0	1
0	0	0	0	0	0	1	0	0	0	0	0	0	0	0	0	0
TIME																
EVENTID_FCE = 0x0508																
SID_FCE = 0x5107																
OBSID_FCE																
BBID_FCE																
EVENTCOUNT_FCE																
FIFOID_FCE																
CHKWORDEX_FCE																
CHKWORDRD_FCE																
Checksum																

Parameter	Comment
EVENTID_FCE	0x0508
SID_FCE	0x5107
OBSID_FCE	Observation ID
BBID_FCE	Building Block ID
EVENTCOUNT_FCE	Sequential counter for TM(5,1) events
FIFOID_FCE	ID of the FIFO where the frame was read from
CHKWORDEX_FCE	XOR checksum computed on the read frame
CHKWORDRD_FCE	Checksum word read at the end of the received frame



4.2.5.1.9 Subsystem Timeout Error

This is issued when the DRCU responds with a timeout to a sent command.

0	0	0	0	1	APID1											
1	1	Count														
Length = 33																
0	0	0	0	0	0	0	0	0	0	0	0	0	0	1	0	1
0	0	0	0	0	0	1	0	0	0	0	0	0	0	0	0	0
TIME																
EVENTID_STE = 0x050B																
SID_STE = 0x5108																
OBSID_STE																
BBID_STE																
EVENTCOUNT_STE																
COMMAND_STE																
RESPONSE_STE																
Checksum																

Parameter	Comment
EVENTID_STE	0x050B
SID_STE	0x5108
OBSID_STE	Observation ID
BBID_STE	Building Block ID
EVENTCOUNT_STE	Sequential counter for TM(5,1) events
COMMAND_STE	Copy of command sent to DRCU (32 bits)
RESPONSE_STE	Copy of command echo returned by DRCU (32bits)

4.2.5.1.10 Subsystem Response Error

This is issued when there is an error in the transmission of a GET command to the DRCU, i.e. when the CID returned by the DRCU is not identical to the CID sent.

0	0	0	0	1	APID1											
1	1	Count														
Length = 37																
0	0	0	0	0	0	0	0	0	0	0	0	0	0	1	0	1
0	0	0	0	0	0	1	0	0	0	0	0	0	0	0	0	0
TIME																
EVENTID_SRE = 0x050C																
SID_SRE = 0x5109																
OBSID_SRE																
BBID_SRE																
EVENTCOUNT_SRE																
COMMAND_SRE																
RESPONSE_SRE																
Checksum																

Parameter	Comment
EVENTID_SRE	0x050C
SID_SRE	0x5109
OBSID_SRE	Observation ID
BBID_SRE	Building Block ID
EVENTCOUNT_SRE	Sequential counter for TM(5,1) events
COMMAND_SRE	Copy of command sent to DRCU (32 bits)
RESPONSE_SRE	Copy of command echo returned by DRCU (32bits)



4.2.5.1.11 DPU Pool Error

This (a warning more than an error) is issued when the DPU internal memory pools (where the TM packets are stored before being sent to the 1553 I/F, it will be detailed in the ADD some time) reach a 80% occupation.

0	0	0	0	1	APID1										
1	1	Count													
Length = 37															
0	0	0	0	0	0	0	0	0	0	0	0	0	1	0	1
0	0	0	0	0	0	1	0	0	0	0	0	0	0	0	0
TIME															
EVENTID_DPE = 0x050D															
SID_DPE = 0x510A															
OBSID_DPE															
BBID_DPE															
EVENTCOUNT_DPE															
POOLID_DPE															
NPKT_DPE															
MAXPKT_DPE															
TERROR_DPE															
Checksum															

Parameter	Comment
EVENTID_DPE	0x050D
SID_DPE	0x510A
OBSID_DPE	Observation ID
BBID_DPE	Building Block ID
EVENTCOUNT_DPE	Sequential counter for TM(5,1) events
POOLID_DPE	ID of the VIRTUOSO Pool which failed to allocate block. IDs are defined in RD08
NPKT_DPE	Number of packets currently present in pool
MAXPKT_DPE	Maximum number of packets in pool
TERROR_DPE	Time When Error Occurred (48 bits)



4.2.5.1.12 DPU FIFO Error

This (a warning more than an error) is issued when the DPU internal VIRTUOSO FIFOs (used to exchange messages between OBS tasks, it will be detailed in the ADD some time) reach a 80% occupation.

0	0	0	0	1	APID1											
1	1	Count														
Length = 37																
0	0	0	0	0	0	0	0	0	0	0	0	0	0	1	0	1
0	0	0	0	0	0	1	0	0	0	0	0	0	0	0	0	0
TIME																
EVENTID_DFE = 0x050E																
SID_DFE = 0x510B																
OBSID_DFE																
BBID_DFE																
EVENTCOUNT_DFE																
FIFOID_DFE																
NMSG_DFE																
MAXMSG_DFE																
TERROR_DFE																
Checksum																

Parameter	Comment
EVENTID_DFE	0x050E
SID_DFE	0x510B
OBSID_DFE	Observation ID
BBID_DFE	Building Block ID
EVENTCOUNT_DFE	Sequential counter for TM(5,1) events
FIFOID_DFE	ID of the VIRTUOSO FIFO
NMSG_DFE	Number of messages currently present in FIFO
MAXMSG_DFE	Maximum number of messages in FIFO
TERROR_DFE	Time When Error Occurred (48 bits)

4.2.5.1.13 LS Overflow Error

The number of commands send to the DRCU exceeds the maximum allowed rate.

0	0	0	0	1	APID1											
1	1	Count														
Length = 29																
0	0	0	0	0	0	0	0	0	0	0	0	0	0	1	0	1
0	0	0	0	0	0	1	0	0	0	0	0	0	0	0	0	0
TIME																
EVENTID_LOE = 0x050F																
SID_LOE = 0x510C																
OBSID_LOE																
BBID_LOE																
EVENTCOUNT_LOE																
LSLOAD_LOE																
Checksum																

Parameter	Comment
EVENTID_LOE	0x050F
SID_LOE	0x510C
OBSID_LOE	Observation ID
BBID_LOE	Building Block ID
EVENTCOUNT_LOE	Sequential counter for TM(5,1) events
LSLOAD_LOE	Number of microseconds that the LSL was busy during the last second



4.2.5.1.14 Unknown TM Packet Error

A TM packet ready to be sent has an unknown combination of Type/Subtype and SID

0	0	0	0	1	APID1									
1	1	Count												
Length = 31														
0	0	0	0	0	0	0	0	0	0	1	0	1	1	
0	0	0	0	0	0	1	0	0	0	0	0	0	0	0
TIME														
EVENTID_UTPE = 0x0510														
SID_UTPE = 0x510D														
OBSID_UTPE														
BBID_UTPE														
EVENTCOUNT_UTPE														
											TYPE_UTPE			
SUBTYPE_UTPE														
SID_UTPE														
Checksum														

Parameter	Comment
EVENTID_UTPE	0x0510
SID_UTPE	0x510D
OBSID_UTPE	Observation ID
BBID_UTPE	Building Block ID
EVENTCOUNT_UTPE	Sequential counter for TM(5,1) events
TYPE_UTPE	Type and subtype of unknown TM packet (copy of part of TM packet Data Field Header)
SUBTYPE_UTPE	
SID_UTPE	SID of unknown TM packet

4.2.5.1.15 No DCU Response Error

The DCU does not respond to a "SET" or "GET" command.

0	0	0	0	1	APID1									
1	1	Count												
Length = 29														
0	0	0	0	0	0	0	0	0	0	0	1	0	1	1
0	0	0	0	0	0	1	0	0	0	0	0	0	0	0
TIME														
EVENTID_NDRE = 0x0520														
SID_NDRE = 0x510E														
OBSID_NDRE														
BBID_NDRE														
EVENTCOUNT_NDRE														
COMMAND_NDRE														
Checksum														

Parameter	Comment
EVENTID_NDRE	0x0520
SID_NDRE	0x510E
OBSID_NDRE	Observation ID
BBID_NDRE	Building Block ID
EVENTCOUNT_NDRE	Sequential counter for TM(5,1) events
COMMAND_NDRE	Copy of command sent to DRCU (32bits)



4.2.5.1.16 No MCU Response Error

The MCU does not respond to a “SET” or “GET” command.

0	0	0	0	1	APID1											
1	1	Count														
Length = 29																
0	0	0	0	0	0	0	0	0	0	0	0	0	0	1	0	1
0	0	0	0	0	0	1	0	0	0	0	0	0	0	0	0	0
TIME																
EVENTID_NMRE = 0x0521																
SID_NMRE = 0x510F																
OBSID_NMRE																
BBID_NMRE																
EVENTCOUNT_NMRE																
COMMAND_NMRE																
Checksum																

Parameter	Comment
EVENTID_NMRE	0x0521
SID_NMRE	0x510F
OBSID_NMRE	Observation ID
BBID_NMRE	Building Block ID
EVENTCOUNT_NMRE	Sequential counter for TM(5,1) events
COMMAND_NMRE	Copy of command sent to DRCU (32bits)

4.2.5.1.17 No SCU Response Error

The SCU does not respond to a “SET” or “GET” command.

0	0	0	0	1	APID1										
1	1	Count													
Length = 29															
0	0	0	0	0	0	0	0	0	0	0	0	0	1	0	1
0	0	0	0	0	0	1	0	0	0	0	0	0	0	0	0
TIME															
EVENTID_NSRE = 0x0522															
SID_NSRE = 0x5110															
OBSID_NSRE															
BBID_NSRE															
EVENTCOUNT_NSRE															
COMMAND_NSRE															
Checksum															

Parameter	Comment
EVENTID_NSRE	0x0522
SID_NSRE	0x5110
OBSID_NSRE	Observation ID
BBID_NSRE	Building Block ID
EVENTCOUNT_NSRE	Sequential counter for TM(5,1) events
COMMAND_NSRE	Copy of command sent to DRCU (32bits)



4.2.5.1.18 TC Sequence Error

This event is issued when there is a gap in the TC sequence number.

0	0	0	0	1	APID1											
1	1	Count														
Length = 29																
0	0	0	0	0	0	0	0	0	0	0	0	0	0	1	0	1
0	0	0	0	0	0	1	0	0	0	0	0	0	0	0	0	0
TIME																
EVENTID_TSE = 0x0511																
SID_TSE = 0x5111																
OBSID_TSE																
BBID_TSE																
EVENTCOUNT_TSE																
LAST_TC_COUNT_TSE																
CURR_TC_COUNT_TSE																
Checksum																

Parameter	Comment
EVENTID_TSE	0x0511
SID_TSE	0x5111
OBSID_TSE	Observation ID
BBID_TSE	Building Block ID
EVENTCOUNT_TSE	Sequential counter for TM(5,1) events
LAST_TC_COUNT_TSE	Previous TC PKT SEQ Count
CURR_TC_COUNT_TSE	Current TC PKT SEQ Count



4.2.5.1.19 Out of Limit Error

00001	APID1
11	Count
Length=25	
00000000000000000101	
00000000010000000000	
TIME	
EVENTID_OOL	
SID_OOL = 0x5112	
OBSID_OOL	
BBID_OOL	
EVENTCOUNT_OOL	
PARMID_OOL	
PARMVALUE_OOL	
Checksum	

Parameter	Comment
EVENTID_OOL	Event ID – see table below
SID_OOL	0x5112
OBSID_OOL	Observation ID
BBID_OOL	Building Block ID
EVENTCOUNT_OOL	Sequential counter of events of this type/subtype
PARMID_OOL	Monitoring Parameter ID of parameter which has gone out of limits
PARMVALUE_OOL	Value of the Monitoring Parameter which has gone out of limits

Error	EVENTID_OOL	Event ID – see table below
POWER_FAILURE	0x5100	A monitored power rail in the DRCU is out of limits PARMID has the following values: SCUP5V = SCUP9V = SCUM9V = SCUP25V = MCUP5V = MCUP15V = MCUM15V = MCUP13V = MCUM13V = BIAS5V = BIASP9V = BIASM9V = PLIAP5V = PLIAP9V = PLIAM9V = SLIAP5V = SLIAP9V = SLIAM9V = DPU parms TBD
BTEMP_FAILURE	0x5110	TBW
THERM_FAILURE	0x5120	TBW
HEATER_FAILURE	0x5130	TBW
MCU_FATAL_ERROR	0x5140	TBW
CONFIG_ERROR	0x5150	TBW



4.2.5.2 Exception Report (5,2)

These reports normally indicate an anomaly with the instrument that cannot be dealt with by the DPU and that action should be taken by the spacecraft.

4.2.5.2.1 Anomaly without parameters

0	0	0	0	1	APID1											
1	1	Count														
Length=25																
0	0	0	0	0	0	0	0	0	0	0	0	0	0	1	0	1
0	0	0	0	0	1	0	0	0	0	0	0	0	0	0	0	0
TIME																
EVENTID_AWP																
SID_AWP = 0x5200																
OBSID_AWP																
BBID_AWP																
EVENTCOUNT_AWP																
Checksum																

Parameter	Comment
EVENTID_AWP	Event ID – see table below
SID_AWP	0x5200
OBSID_AWP	Observation ID
BBID_AWP	Building Block ID
EVENTCOUNT_AWP	Sequential counter of events of this type/subtype

Error	EVENTID_AWP	Event ID – see table below
DRCU_Anomaly	0xC000	OBS has detected an unrecoverable anomaly in the DRCU. The expected action is for the CDMS to switch off the DRCU.
DPU_Anomaly	0xC010	OBS has detected an unrecoverable anomaly in the DPU. The expected action is for the CDMS to switch off the DPU and DRCU.
Observation_Anomaly	0xC100	OBS has detected a problem during an observation. The expected action is for the CDMS to suspend SPIRE commanding until the instrument is ready to resume.
Observation_Corrected	0xC110	The OBS has corrected and observation anomaly - Resume SPIRE Commanding with the next subschedule.
Function_Unarmed	0x0832	Attempt to engage or disengage the SMEC Launch Latch when the function is not active. Action by the CDMS is TBD



4.2.5.2.2 Boot ROM Memory Check

This packet is generated by the Boot ROM after checking the memory contents provided no errors are found.

Note: This packet does not conform to the format defined for Event Packets in AD01 and is TBC

0	0	0	0	1	APID1											
1	1	Count														
Length=17																
0	0	0	0	0	0	0	0	0	0	0	0	0	0	1	0	1
0	0	0	0	0	0	1	0	0	0	0	0	0	0	0	0	0
TIME (0x800000000000)																
SID?																
SUBSID?																
NERRORS?																
Checksum																

Parameter	Comment
TIME	This value has the msb set to indicate that the time is invalid
EVENTID	0x8008
SID	0x0003
NERRORS	(0x0000)



4.2.5.3 Error/Alarm Report (5,4)

4.2.5.3.1 Memory Check Errors

Generated when the Boot Software memory check fails (ref RD10).

Note: This packet does not conform to the format defined for Event Packets in AD01

0	0	0	0	1	APID1									
1	1	Count												
Length														
0	0	0	0	0	0	0	0	0	0	0	0	1	0	1
0	0	0	0	1	0	0	0	0	0	0	0	0	0	0
TIME (0x800000000000)														
EVENTID_MCE														
SID_MCE=0x00FF														
MEMID_MCE		NPAGES_MCE												
Page IDs														
Checksum														

Parameter	Comment
TIME	This value has the msb set to indicate that the time is invalid
EVENTID_MCE	Event ID - see table below
SID_MCE	0x00FF
MEMID_MCE	Memory type (2 bits)
NPAGES_MCE	Number of failed memory pages (14bits)
Page IDs	A list of the IDs of each failed page (16 bits per ID) For EEPROM the ID may also be interpreted as an error code

Error	EVENTID_MCE	MEMID_MCE	Event ID – see table below
PM_Error	0x8001	1	The Boot SW has detector one or more errors in the Program Memory
DM_Error	0x8002	2	The Boot SW has detector one or more errors in the Data Memory.
EEPROM_Error	0x8003	3	The Boot SW has detector one or more errors in the EEPROM



Project Document

SPIRE Data ICD

Ref: SPIRE-RAL-PRJ-001078
Issue: Issue 2.0
Date: 15th November 2004
Page: 93 of 143

4.2.5.3.2 Telecommand Validation Errors

Generated when the Boot Software telecommand check fails (ref RD10).

Note: This packet does not conform to the format defined for Event Packets in AD01

0	0	0	0	1	APID1											
1	1	Count														
Length = 27																
0	0	0	0	0	0	0	0	0	0	0	0	0	0	1	0	1
0	0	0	0	0	1	0	0	0	0	0	0	0	0	0	0	0
TIME (0x800000000000)																
EVENTID_TVE																
SID_TVE																
INFO_TVE																
ERRCODE_TVE																
FCSCOMP_TVE																
FCSREAD_TVE																
CHKSUMID_TVE																
DMADDR_TVE																
Checksum																

Parameter	Comment
TIME	This value has the msb set to indicate that the time is invalid
EVENTID_TVE	0x8004
SID_TVE	0x0009
INFO_TVE	Information on the error – see table below
ERRCODE_TVE	Error code – see table below
FCSCOMP_TVE	Computed FCS – see table below
FCSREAD_TVE	Read FCS – see table below
CHKSUMID_TVE	Checksum error type – see table below
DMADDR_TVE	Start address in DM – see table below

Note: some parameters are not applicable for some Error Codes. In these cases the parameters are replaced by 0xAAAA

Error	ERRCODE_TVE	INFO_TVE	FCSCOMP_TVE	FCSREAD_TVE	CHKSUMID_TVE	DMADDR_TVE
Data_Memory_FCS_Error	0x0008	Options loading memory	Computed Value	Value Read	0x0001	Start Address of Overlapped Memory Page
TC_FCS_Error	0x0008	0xAAAA	Computed Value	Value Read	0x0002	0xAAAA
TC_APID_Error	0x000C	APID Received	0xAAAA	0xAAAA	0xAAAA	0xAAAA
TC_Wrong_Function_ID_Error	0x0010	Function ID Received	0xAAAA	0xAAAA	0xAAAA	0xAAAA
Data_Memory_Wrong_Function_Error	0x0010	TC options for loading memory	0xAAAA	0xAAAA	0xAAAA	0xAAAA
Packet_Type_Error	0x000E	Type & Subtype Received	0xAAAA	0xAAAA	0xAAAA	0xAAAA
Packet_Subtype_Error	0x000B	Type & Subtype Received	0xAAAA	0xAAAA	0xAAAA	0xAAAA
Data_Memory_Page_Overlap_Error	0x000A	0xAAAA	0xAAAA	0xAAAA	0xAAAA	Start Address of Overlapped Memory Page
Data_Memory_Page_Lost_Error	0x0009	TC options for loading memory	0xAAAA	0xAAAA	0xAAAA	Start Address of Overlapped Memory Page
Data_Memory_Wrong_Format_Error	0x0007	TC options for loading memory	0xAAAA	0xAAAA	0xAAAA	Start Address of Overlapped Memory Page
Data_Memory_Uploading_Boundaries_Error	0x0012	0xAAAA	0xAAAA	0xAAAA	0xAAAA	0xAAAA
Data_Memory_Wrong_Activity_Error	0x0011	TC options for loading memory	0xAAAA	0xAAAA	0xAAAA	0xAAAA



4.2.5.3.3 EEPROM to PM Loading Errors

Generated when the Boot Software data transfer from EEPROM or Data Memory to PM fails (ref RD10).

Note: This packet does not conform to the format defined for Event Packets in AD01

0	0	0	0	1	APID1										
1	1	Count													
Length = 19															
0	0	0	0	0	0	0	0	0	0	0	0	0	1	0	1
0	0	0	0	0	1	0	0	0	0	0	0	0	0	0	0
TIME (0x800000000000)															
EVENTID_EPMLE															
SID_EPMLE															
MEMTYPE			NPAGES												
ERRCODE_EPMLE															
Checksum															

Parameter	Comment
TIME	This value has the msb set to indicate that the time is invalid
EVENTID_EPMLE	0x8005
SID_EPMLE	0x0001
MEMTYPE_EPLME (2 bits)	EEPROM Memory = 3
NPAGES_EPLME (14 bits)	Number of pages failed = 0x0001
ERRCODE_EPLME	0x1800 = Overlapping between two memory pages 0x0400 = No partition to boot 0x0800 = Total FCS Error 0x0C00 = PM FCS Error during page upload 0x1400 = Previous EEPROM test failed 0x1800 = Overlapping between two memory pages

4.2.5.3.4 DM to PM Loading Errors

Generated when the Boot Software data transfer from EEPROM or Data Memory to PM fails (ref RD10).

Note: This packet does not conform to the format defined for Event Packets in AD01

0	0	0	0	1	APID1										
1	1	Count													
Length = 19															
0	0	0	0	0	0	0	0	0	0	0	0	0	1	0	1
0	0	0	0	0	1	0	0	0	0	0	0	0	0	0	0
TIME (0x800000000000)															
EVENTID_DPMLE															
SID_DPMLE															
MEMTYPE			NPAGES												
ERRCODE_DPMLE															
Checksum															

Parameter	Comment
TIME	This value has the msb set to indicate that the time is invalid
EVENTID_DPMLE	0x8006
SID_DPMLE	0x0001
MEMTYPE_DPLME (2 bits)	Data Memory = 2
NPAGES_DPLME (14 bits)	Number of pages failed = 0x0001
ERRCODE_DPLME	0x0C00 = PM FCS Error during page upload 0x1800 = Overlapping between two memory pages 0x1900 = PM Memory Page Boundaries Uploading error



4.2.5.3.5 PM Boot Errors

Generated when the Boot Software DM -to-PM Immediate Boot fails (ref RD10).

Note: This packet does not conform to the format defined for Event Packets in AD01

0	0	0	0	1	APID1											
1	1	Count														
Length = 19																
0	0	0	0	0	0	0	0	0	0	0	0	0	0	1	0	1
0	0	0	0	0	1	0	0	0	0	0	0	0	0	0	0	0
TIME (0x800000000000)																
EVENTID_PMBE																
SID_PMBE																
MEMTYPE							NPAGES									
ERRCODE_PMBE																
Checksum																

Parameter	Comment
TIME	This value has the msb set to indicate that the time is invalid
EVENTID_PMBE	0x8007
SID_PMBE	0x0001
MEMTYPE_PMBE (2 bits)	Program Memory = 1
NPAGES_PMBE (14 bits)	Number of pages failed = 0x0001
ERRCODE_PMBE	0x0800 = Program FCS error – the computed FCS on the whole program is wrong



4.2.8 Function Management

This report is issued in response to TC (8,5). Three report formats are defined

4.2.8.1 Normal Functions Report

These correspond to Function IDs 0x01, 0x10, 0x70, 0xC0 and 0xC1

0	0	0	0	1	APID1											
1	1	Count														
Length = 15																
0	0	0	0	0	0	0	0	0	0	0	0	0	1	0	0	0
0	0	0	0	0	1	1	0	0	0	0	0	0	0	0	0	0
TIME																
FUNCTIONID			ACTIVITYID													
SID																
Checksum																

Parameters

Name	Value and Comments
FUNCTIONID	ID of function to be reported
ACTIVITYID	Current Activity = 00 if function is stopped = FF if function is active and waiting
SID	= 0x0000 indicates no parameters

4.2.8.2 VM Functions Report

These correspond to Function IDs 0x02, 0x03, 0x04 and 0x05

0	0	0	0	1	APID1											
1	1	Count														
Length																
0	0	0	0	0	0	0	0	0	0	0	0	0	1	0	0	0
0	0	0	0	0	1	1	0	0	0	0	0	0	0	0	0	0
TIME																
FUNCTIONID			ACTIVITYID													
SID																
TABLEID																
INDEX																
N																
Data																
Checksum																

Parameters

Name	Value and Comments
FUNCTIONID	ID of function to be reported
ACTIVITYID	Current Activity = 01 when Executing a Command List = 02 when Running from a table = 03 when Halted
SID	0x0860
TABLEID	Table containing Co mmand List Not applicable when ACTIVITYID = 01
INDEX	Index within Table to start executing Not applicable when ACTIVITYID = 01
N	Number of Data words
Data	N*32 bit data words



4.2.8.3 DPU Functions Report

These correspond to Function ID 0xCA

0	0	0	0	1	APID1											
1	1	Count														
Length =19																
0	0	0	0	0	0	0	0	0	0	0	0	0	1	0	0	0
0	0	0	0	0	1	1	0	0	0	0	0	0	0	0	0	0
TIME																
FUNCTIONID			ACTIVITYID													
SID																
N																
FRAMEID																
SELSID																
TABLEID																
.....																
Checksum																

Parameters

Name	Value and Comments
FUNCTIONID	ID of function to be reported
ACTIVITYID	Current Activity = 10 when selecting = 11 when not selecting
SID	0x0861
N	Number of times FRAMEID, SELSID and TABLEID are repeated
FRAMEID	Science Frame data is selected from
SELSID	SID for the Select TM Packets
TABLEID	Table containing the selection information (= 0xffff if not selected)

Note: the group FRAMID, SELSID, TABLEID are repeated 24 times in this packet



4.2.9 Time Management

4.2.9.1 Time Verification Report

This report is generated in response to TC(9,7)

0	0	0	0	1	APID1										
1	1	Count													
Length = 17															
0	0	0	0	0	0	0	0	0	0	0	0	1	0	0	1
0	0	0	0	1	0	0	1	0	0	0	0	0	0	0	0
TIME															
TDPU															
Checksum															

Parameters

Name	Value and Comments
TDPU	Copy of the On board time held by the DPU

4.2.10

Not Available

4.2.11 On Board Scheduling

Not Used

4.2.12 On Board Monitoring

Not Used

4.2.13

Not Available

4.2.14 Packet Transmission Control

This report is issued in response to TC (14,3) and lists all the enabled TM packets.

0	0	0	0	1	APID1										
1	1	Count													
Length															
0	0	0	0	0	0	0	0	0	0	0	0	1	1	1	0
0	0	0	0	1	0	0	0	0	0	0	0	0	0	0	0
TIME															
NDEF															
Type			Subtype												
Packet ID															
Type			Subtype												
Packet ID															
Checksum															

Parameters

Name	Value and Comments
NDEF	Number of sets of (Type, Subtype, SID) to follow
Type	Packet Type
Subtype	Packet Subtype
Packet ID	Identifier of specific groups of packets: If all packets of the given type/subtype are enabled = 0x0000 For Type = 3: this field contains the HK_Packet_ID For Type = 5: this field contains the Event ID For Type = 21: this field contains the SID



4.2.15 On Board Storage and Retrieval

Not Used

4.2.16 On Board Traffic Management

Not Used

4.2.17 Test Service

This report is generated in response to TC (17,1)

0	0	0	0	1	APID1												
1	1	Count															
Length = 17																	
0	0	0	0	0	0	0	0	0	0	0	0	0	1	0	0	0	1
0	0	0	0	0	0	1	0	0	0	0	0	0	0	0	0	0	0
TIME																	
Checksum																	

4.2.18 On Board Control Procedures

Not Used

4.2.19 Action/Event Service

Not Used

4.2.20 Information Distribution Service

Not Used



4.2.21 Science Data

4.2.21.1 Nominal Science Data Report (21,1)

0	0	0	0	1	APID										
1	1	Count													
Length															
0	0	0	0	0	0	0	0	0	0	0	1	0	1	0	1
0	0	0	0	0	0	1	0	0	0	0	0	0	0	0	0
TIME															
<i>SID</i>															
OBSID															
BBID															
<i>Parameters</i>															
Checksum															

The reports available are identified by the APID (APID3 = Photometer, APID4 = Spectrometer and APID5 = Subsystem Data) and the SID (composed of the Frame Structure (MSByte) and FrameID (LSByte)):

APID	SID	Report
APID3	0x0200	Photometer Full Array
APID3	0x1200	Photometer Parallel Mode Selection
APID4	0x0201	Spectrometer Full Array
APID3	0x1201	Spectrometer Parallel Mode Selection
APID5	0x0410	SMEC
APID5	0x1410	SMEC Selection
APID5	0x0612	BSM
APID5	0x0A20	SCU

The *parameters* field contains one or more blocks of science data all of the same type. These blocks are the same as the science data frames issued by the DRCU, except for the DPU Block, which is created by the DPU. Normally the DPU fills the TM packet with the maximum number of blocks before the packet is made available for transmission. In the event of a **flush_fifo** telecommand the packet is transmitted immediately and will not be filled. The **length** field, with the APID and SID, allows the number of blocks in the packet to be calculated.

The possible block types are as follows:



4.2.21.1.1 Photometer Full Array Block

This block of data is inserted in the *Parameter* field once.

Block Length=294
FrameID=0x00
288 Detector Values
ADC_Flags
Frame_Time MSW
Frame_Time LSW
Checksum

The order of the detectors in the block is shown in Appendix D

4.2.21.1.2 Spectrometer Full Array Block

Block Length=78
FrameID=0x01
72 Detector Values
ADC_Flags
Frame_Time MSW
Frame_Time LSW
Checksum

The order of the detectors in the block is shown in Appendix D



4.2.21.1.3 SMEC Block

In order to meet the telemetry bit rate requirements, this block is normally selected (see TM(21,2)).

This is the default block contents – it may be changed by command to the MCU.

Block Length=12
FrameID=0x10
Acquisition date MSW
Acquisition date LSW
SMECENCPOSN
SMECENCFINEPOSN
SMECLVDTPOSN
CMDMOTORCURR
SMECMOTORBEMF
Transmission Time MSW
Transmission Time LSW
Checksum



4.2.21.1.4 BSM Block

This is the default block contents – it may be changed by command to the MCU.

Block Length=13
FrameID=0x12
Acquisition date MSW
Acquisition date LSW
CHOPSENSSIG
CHOPMOTORCURR
CHOPBEMF
JIGGSENSSIG
JIGGMOTORCURR
JIGGBEMF
Transmission_Time MSW
Transmission_Time LSW
Checksum



4.2.21.1.5 SCU Block

Block Length=30
FrameID=0x20
PUMPHTRTEMP
PUMPHSTEMP
EVAPHSTEMP
SHUNTTEMP
SOBTEMP
SL0TEMP
PL0TEMP
OPTTEMP
BAFTEMP
BSMIFTEMP
SCAL2TEMP
SCAL4TEMP
SCALTEMP
SMECIFTEMP
SMECTEMP
BSMTEMP
SUBKTEMP
TCHTRV
PCALCURR
PCALV
SCAL2CURR
SCAL2V
SCAL4CURR
SCAL4V
ADC_Flags
Frame_Time MSW
Frame_Time LSW
Checkword



4.2.21.1.6

4.2.21.1.6 SID = 0x1410: SMEC Selected Data

Acquisition Time MSW
Aquisition Time LSW
SMECENCPOSN
SMECENCFINEPOSN
SMECLVDTPOSN
SMECMOTORBEMF

4.2.21.1.7 SID = 0x1200: Photometer Parallel Mode Selected Data

TBD

4.2.21.1.8 SID = 0x1201: Spectrometer Parallel Mode Selected Data

TBD



4.2.21.2 Science Type B Data Report (21,2)

00001	APID
11	Count
	Length
00000000000010101	
00000001000000000	
	TIME
	SID
	OBSID
	BBID
	Parameters
	Checksum

The reports available are identified by the APID (APID3 = Photometer, APID4 = Spectrometer) and the SID (composed of the Frame Structure (MSByte) and FrameID (LSByte)):

APID	SID	Report
APID3	0x0102	PSW Array
APID3	0x0103	PMW Array
APID3	0x0104	PLW Array
APID4	0x0105	SSW Array
APID4	0x0106	SLW Array

The *parameters* field contains one or more blocks of science data all of the same type.

These blocks are the same as the science data frames issued by the DRCU, except in the case of the Selected Data Report.

Normally the DPU fills the TM packet with the maximum number of blocks before the packet is made available for transmission. In the event of a **flush_fifo** telecommand the packet is transmitted immediately and will not be filled. The **length** field, with the APID and SID, allows the number of blocks in the packet to be calculated.

The possible block types are as follows:



4.2.21.2.1 PSW Array Block

Block Length=150
FrameID=0x02
144 Detector Values
ADC_Flags
Frame_Time MSW
Frame_Time LSW
Checksum

The order of the detectors in the block is shown in Appendix D

4.2.21.2.2 PMW Array Block

Block Length=102
FrameID=0x03
96 Detector Values
ADC_Flags
Frame_Time MSW
Frame_Time LSW
Checksum

The order of the detectors in the block is shown in Appendix D

4.2.21.2.3 PLW Array Block

Block Length=54
FrameID=0x04
48 Detector Values
ADC_Flags
Frame_Time MSW
Frame_Time LSW
Checksum

The order of the detectors in the block is shown in Appendix D



4.2.21.2.4 SSW Array Block

Block Length=54
FrameID=0x05
48 Detector Values
ADC_Flags
Frame_Time MSW
Frame_Time LSW
Checksum

The order of the detectors in the block is shown in Appendix D

4.2.21.2.5 SLW Array Block

Block Length=30
FrameID=0x06
24 Detector Values
ADC_Flags
Frame_Time MSW
Frame_Time LSW
Checksum

The order of the detectors in the block is shown in Appendix D



Project Document

SPIRE Data ICD

Ref: SPIRE-RAL-PRJ-001078

Issue: Issue 2.0

Date: 15th November 2004

Page: 110 of 143



4.2.21.3 Diagnostic Science Report (21,3)

00001	APID
11	Count
	Length
0000000000000101011	
0000000110000000000	
	TIME
	SID
	OBSID
	BBID
	Parameters
	Checksum

The reports available are identified by the APID (APID3 = Photometer, APID4 = Spectrometer and APID5 = Subsystem Data) and the SID (composed of the Frame Structure (MSByte) and FrameID (LSByte)):

APID	SID	Report
APID3	0x0309	Photometer Test Pattern
APID3	0x030A	PSW Test Pattern
APID3	0x030B	PMW Test Pattern
APID3	0x030C	PLW Test Pattern
APID4	0x030D	Spectrometer Test Pattern
APID4	0x030E	SSW Test Pattern
APID4	0x030F	SLW Test Pattern
APID5	0x0814	MCU Engineering
APID5	0x0915	MCU Test Pattern
APID5	0x1121	SCU Test Pattern
APID5	0xFF00	Transparent Data

The *parameters* field contains one or more blocks of science data all of the same type. These blocks are the same as the science data frames issued by the DRCU, with the exception of the Transparent Data

Normally the DPU fills the TM packet with the maximum number of blocks before the packet is made available for transmission. In the event of a **flush_fifo** telecommand the packet is transmitted immediately and will not be filled. The **length** field, with the APID and SID, allows the number of blocks in the packet to be calculated.

The possible block types are as follows:



4.2.21.3.1 Photometer Full Test Pattern Block

This block of data is inserted in the *Parameter* field once.

Block Length=294
FrameID=0x09
288 Test Values
ADC_Flags
Frame_Time MSW
Frame_Time LSW
Checksum

The content of the Test Values is TBD



4.2.21.3.2 Photometer SW Test Pattern Block

Block Length=150
FrameID=0x0A
144 Test Values
ADC_Flags
Frame_Time MSW
Frame_Time LSW
Checksum

The content of the Test Values is TBD

4.2.21.3.3 Photometer MW Test Pattern Block

Block Length=102
FrameID=0x0B
96 Test Values
ADC_Flags
Frame_Time MSW
Frame_Time LSW
Checksum

The content of the Test Values is TBD

4.2.21.3.4 Photometer SW Test Pattern Block

Block Length=54
FrameID=0x0C
48 Test Values
ADC_Flags
Frame_Time MSW
Frame_Time LSW
Checksum

The content of the Test Values is TBD



4.2.21.3.5 Spectrometer Full Test Pattern Block

Block Length=78
FrameID=0x0D
72 Test Values
ADC_Flags
Frame_Time MSW
Frame_Time LSW
Checksum

The content of the Test Values is TBD

4.2.21.3.6 Spectrometer SW Test Pattern Block

Block Length=54
FrameID=0x0E
48 Test Values
ADC_Flags
Frame_Time MSW
Frame_Time LSW
Checksum

The content of the Test Values is TBD

4.2.21.3.7 Spectrometer LW Test Pattern Block

Block Length=30
FrameID=0x0F
24 Test Values
ADC_Flags
Frame_Time MSW
Frame_Time LSW
Checksum

The content of the Test Values is TBD



4.2.21.3.8 MCU Engineering Block

This block is available to transmit any MCU parameters to the ground as science telemetry. The default parameters are given in the table below. Any parameter may be replaced by command to the MCU.

Block Length=21
FrameID=0x14
Acquisition date MSW
Acquisition date LSW
SMECENCCOUNT
SMECENC SIG1
SMECENC SIG2
SMECENC SIG3
SMECLVDTDCSIG
SMECLVDTAC SIG
SMECMOTORCURREN
SMECMOTORVOLT
CHOPSENS SIG
CHOPMOTORCURREN
CHOPMOTORVOLT
JIGGSENS SIG
JIGGMOTORCURREN
JIGGMOTORVOLT
Transmission_Time MSW
Transmission_Time LSW
Checksum



4.2.21.3.9 MCU Test Pattern Block

Block Length=21
FrameID=0x15
Acquisition date MSW
Acquisition date LSW
0x5555
0xAAAA0x5554
0xAAA8
0x5550
0xAAA0
0x5541
0xAAA2
0x5505
0xAA0A
0x5414
0xA828
0x5050
0xA0A0
Transmission_Time MSW
Transmission_Time LSW
Checksum

4.2.21.3.10 SCU Test Pattern Block

Block Length=30
FrameID=0x21
Test Data (24 words)
ADC_Flags
Frame_Time MSW
Frame_Time LSW
Checksum

The content of the Test Data is TBD

4.2.21.3.11 Transparent Data Block

This block is used to transmit science data read directly from a FIFO without any processing of data frames.

It is used if an error is found in the structure of the data held in a FIFO, to dump the contents of the FIFO for diagnostic purposes.



Note: As the FIFO contents could be larger than could be accommodated in one TM packet. The data is sent as a group of packets using the segmentation flags (AD01 – para 4.1.1.2.1) to identify the first, intermediate and last packets.

FIFOID
INDEX
NDATA
FIFO Data

4.2.21.4 Auxiliary Science Data Report (21,4)

00001	APID
11	Count
	Length
000000000000010101	
0000010000000000	
	TIME
	SID
	OBSID
	BBID
	Parameters
	Checksum

The reports available are identified by the APID (APID3 = Photometer, APID4 = Spectrometer) and the SID (composed of the Frame Structure (MSByte) and FrameID (LSByte)):

APID	SID	Report
APID3	0x0207	Photometer Offsets
APID4	0x0208	Spectrometer Offsets
APID5	0x0209	Housekeeping Packet Definition
APID5	0x020A	Report Table Report
APID5	0x020B	VM Science Data

The *parameters* field contains one or more blocks of science data all of the same type. Normally the DPU fills the TM packet with the maximum number of blocks before the packet is made available for transmission. In the event of a **flush_fifo** telecommand the packet is transmitted immediately and will not be filled. The **length** field, with the APID and SID, allows the number of blocks in the packet to be calculated.

The possible block types are as follows:



4.2.21.4.1 Photometer Offsets Block

This block of data is inserted in the *Parameter* field once.

Block Length=294
FrameID=0x07
288 Offsets
ADC_Flags
Frame_Time MSW
Frame_Time LSW
Checksum

The order of the detector offsets in the block is shown in Appendix D

4.2.21.4.2 Spectrometer Offsets Block

Block Length=78
FrameID=0x08
72 Offsets
ADC_Flags
Frame_Time MSW
Frame_Time LSW
Checksum

The order of the detector offsets in the block is shown in Appendix D



4.2.21.4.3 Housekeeping Packet Definition

The reported parameters are those sent in the Housekeeping Packet definition command

HKPCKTID
.....
HKSID
.....
HKINTERVAL
.....
HKREPEAT
.....
TABLEID
.....
MONITOR_TABLEID

4.2.21.4.4 Report Table Report

The parameters field contains the requested table contents.

Note: As the Table contents could be larger than could be accommodated in one TM packet. The data is sent as a group of packets using the segmentation flags (AD01 – para 4.1.1.2.1) to identify the first, intermediate and last packets.

TABLEID
.....
INDEX
.....
NDATA
.....
Table Data

4.2.21.4.5 Context Saving Service

Not Used



5. PARAMETERS

5.1 TC Parameters

5.1.1 Parameter Definition

Parameter Name	Service Reference	Type	Size (bits)	Conversion Curve	Constraint Table	Comments
Activity_ID	(8,4)	Integer	8	None	None	
APID	(20,1) (20,2)	Integer	11	None	None	Application ID
BBID	(8,4)		32			Field is split into 3 parts:
BBINTR		Constant	2	None	None	Location: Bits 0-1 Value: 2
BBTYPE		Integer	14	None	None	Location: Bits 2-15
BBCOUNT		Integer	16	None	None	Location: Bits 16-31
COUNT	(8,4)	Integer	16	None	None	Number of words to be reported
CRC	(6,2)	Unsigned Integer	16	None	None	Cyclic Redundancy Check - algorithm is defined in AD01 – Appendix 4
Data	(6,2) (8,4)					Variable length field of any data type. Must be an integer number of 16 bits in length
FIFOFLAGS	(8,4)		16			Flags indicating the FIFO(s) to flush
FIFODPU		Integer	1	Flush	None	Location: bit 15: DPU science buffer
FIFODCU		Integer	1	Flush	None	Location: bit 14: DCU FIFO
FIFOSCU		Integer	1	Flush	None	Location: bit 13: SCU FIFO
FIFOMCU		Integer	1	Flush	None	Location: bit 12: MCU FIFO
FRAMEID	(8,4)	Integer	16	None	Frame	
FUNCTIONID	(8,1) (8,2) (8,4) (8,5)	Integer	8	Func_ID	None	
HKPCKTID	(3,1) (3,3) (3,9)	Integer	16	None	Hsk_ID	Identifies housekeeping packet definitions
HKSID	(3,1)	Unsigned	16	None	None	Unique identifier for housekeeping parameter list



Project Document

SPIRE Data ICD

Ref: SPIRE-RAL-PRJ-001078

Issue: Issue 2.0

Date: 15th November 2004

Page: 121 of 143

		Integer				Value = 0x03nn where nn = a unique number (starting from 0) defining the report structure
HKINTERVAL	(3,1)	Unsigned Integer	16	None	Period	Time between each packet generated, in milliseconds
INDEX	(8,4)	Unsigned Integer	16	None	None	Offset into a table(in octets)
Length	(6,2) (6,5) (6,9)	Unsigned Integer	16	None	None	
MEMORYID	(6,2) (6,5) (6,9)	Integer	16	Mem_ID	None	ID of Memory Area to be addressed
MODE	(8,4)	Unsigned Integer	16	None	None	Observing Mode
N	(8,4)	Unsigned Integer	16	None	N32	
NCHOP	(8,4)	Integer	16	None	TBD	Number of Chop science data frames to combine into one Chop Science TM Packet
NDATA	(8,4)	Unsigned Integer	16	None	N32	
NDCU	(8,4)	Integer	16	None	TBD	Number of DCU science data frames to combine into one Chop Science TM Packet
NDPU	(8,4)	Integer	16	None	TBD	Number of DPU science data frames to combine into one Chop Science TM Packet
NJIGGLE	(8,4)	Integer	16	None	TBD	Number of Jiggle science data frames to combine into one Chop Science TM Packet
NPCKTS	(14,1) (14,2)	Integer	16	None	None	Number of packet types to follow
NSAU	(6,2) (6,5) (6,9)	Integer	16	None	None	Number of SAUs to transfer
NSCU	(8,4)	Integer	16	None	TBD	Number of SCU science data frames to combine into one Chop Science TM Packet
NSMEC	(8,4)	Integer	16	None	TBD	Number of SMEC science data frames to combine into one Chop Science TM Packet
OBSID	(8,4)	Unsigned Integer	32	None	None	Observation ID



Project Document

SPIRE Data ICD

Ref: SPIRE-RAL-PRJ-001078

Issue: Issue 2.0

Date: 15th November 2004

Page: 122 of 143

		Integer				
Parameters	(8,4)					Variable length field of 32 data words.
SID	(8,1) (8,4) (14,1) (14,2) (20,1) (20,2)	Unsigned Integer	16	None	None	Unique identifier for parameter list
STARTADDR	(6,2) (6,5) (6,9)	Unsigned Integer	16	None	None	Start address of memory area to be addressed
STEP	(8,4)	Unsigned Integer	16	None	None	Observation Step
SUBTYPE	(14,1) (14,2)	Integer	8	None	None	Packet Subtype
TABLEID	(8,4)	Integer	16	None	Tab_ID	Number of an OBS table
TABLESIZE	(8,4)	Integer	16	None	TBD	Table size in 32 bit words
TYPE	(14,1) (14,2)	Integer	8	None	None	Packet Type



5.1.2 Conversion Curves

Name	Type	Raw Value	Converted Value	Comments
Data_Type	Enumerated	0 1 2 3	8Bits 16Bits 24Bits 32Bits	
Func_ID	Enumerated	0x01 0x02 0x03 0x04 0xC0 0xC1 0xCA	Table Cooler SCAL 300mK Ops Obs DPU	TableManagement CoolerControl SCALControl 300mKControl Operations Observations DPU
Info_Type	Enumerated	0 1 2 3	Off Target On Target Start Scan End Scan	
Mem_ID	Enumerated	TBD TBD TBD	PROG DATA EEPROM	
Flush	Enumerated	0 1	Do not flush FIFO Flush FIFO	

5.1.3 Constraints

Name	Type	Minimum Value	Maximum Value	Comments
Bit2	Range	0	3	Value held in lowest 2 bits of field
Frame	Set			Set of possible frame IDs, TBD
Hsk_ID	Range	0	3	Allows up to 4 housekeeping packets to be defined



Project Document

SPIRE Data ICD

Ref: SPIRE-RAL-PRJ-001078
Issue: Issue 2.0
Date: 15th November 2004
Page: 124 of 143

Hsk_Value	Range	0x00000000	0x000FFFFFF	The value is held in lowest 20 bits of the field
N16	Range	1	112	Number of 16 bit data words held in a command
N32	Range	1	56	Number of 32 bit data words held in a command
Nsamples	Range	1	32	
Period	Range	10	60000	Time period expressed as milliseconds - range is 0.01 to 60 seconds
Tab_ID	Range	0	127	

5.2 TM Parameters

5.2.1 Parameter Definition

Name	DRCU Name	Length (bits)	Conversion	Limits	Description
BBID		32			Building Block ID
BBINSTR		2			Instrument (Bits 0,1)
BBTYPE		14			BB type (Bits 2-15)
BBCNT		16			BB sequence count (Bits 16-31)
BIASTEMP	BIAS_TEMP	8	TBD		BIAS Board Temperature
CCUTEMP	CcuTempRd	TBD	TBD	TBD	Temperature from sensor on CCHK Board
CHOPACCELLIMIT	CAccelLimi	16, TBC			
CHOPACCELLOOFSF	CAccelLoopsf	16, TBC			
CHOPBEMF	CBEMF	16, TBC	TBD		
CHOPINTTHRESH	IntegTh	16			Integration threshold for the Chop PID Controller
CHOPKD	CKd	16			Derivative Gain of Chop Axis PID Controller
CHOPKI	CKi	16			Integral Gain of Chop Axis PID Controller
CHOPKP	CKp	16			Proportional Gain of Chop Axis PID Controller
CHOPLATCHSTAT	BSMLaunchLatch1	1	LATCH		Chopper Axis Launch Latch Status
CHOPLOOPMODE	ChopLoopMode	2	CLOOPMODE		Chopper Axis Loop Mode
CHOPMODE	ChopMode	2	CHOPMODE		Chopping Mode



Project Document

SPIRE Data ICD

Ref: SPIRE-RAL-PRJ-001078

Issue: Issue 2.0

Date: 15th November 2004

Page: 125 of 143

CHOPMOTORCURR	CMotorCurrent	16, TBC	TBD		
CHOPMOTORTORQUE	CMotorTorqueC	16, TBC	TBD		
CHOPPERIOD	ChopPeriod	16	PERIOD		Chop Cycle Period
CHOPICNCOEFF1	ICnCoeff1	16, TBC	TBD		
CHOPICNCOEFF2	ICnCoeff2	16, TBC	TBD		
CHOPICNCOEFF3	ICnCoeff3	16, TBC	TBD		
CHOPICNCOEFF4	ICnCoeff4	16, TBC	TBD		
CHOPOUTCoeff1	CoutCoeff1	16, TBC	TBD		
CHOPOUTCoeff2	CoutCoeff2	16, TBC	TBD		
CHOPOUTCoeff3	CoutCoeff3	16, TBC	TBD		
CHOPOUTCoeff4	CoutCoeff4	16, TBC	TBD		
CHOPPOSN	ActualPosition	16			Last Absolute position of the Chopper
CHOPPOSNERR	CMeanPositionError	16			Mean Position Error over a Chopper movement
CHOPPOSNERRLIMIT	CPositionErrorLimit	16			Minimum Value of Chop Position Error that causes a PID error to be reported
CHOPPOSN0	Position0	16			Chopper Axis Position 0
CHOPPOSN1	Position1	16			Chopper Axis Position 1
CHOPRATELIMIT	CRateLimit	16, TBC			
CHOPRATELOOPSF	CRateLoopsf	16, TBC			
CHOPPROFILEVAL01	CprofileValue1	16, TBC	TBD		
CHOPPROFILEVAL02	CprofileValue2	16, TBC	TBD		
CHOPPROFILEVAL03	CprofileValue3	16, TBC	TBD		
CHOPPROFILEVAL04	CprofileValue4	16, TBC	TBD		
CHOPPROFILEVAL05	CprofileValue5	16, TBC	TBD		
CHOPPROFILEVAL06	CprofileValue6	16, TBC	TBD		
CHOPPROFILEVAL07	CprofileValue7	16, TBC	TBD		
CHOPPROFILEVAL08	CprofileValue8	16, TBC	TBD		
CHOPPROFILEVAL09	CprofileValue9	16, TBC	TBD		
CHOPPROFILEVAL10	CprofileValue10	16, TBC	TBD		
CHOPPROFILEVAL11	CprofileValue11	16, TBC	TBD		
CHOPPROFILEVAL12	CprofileValue12	16, TBC	TBD		
CHOPPROFILEVAL13	CprofileValue13	16, TBC	TBD		
CHOPPROFILEVAL14	CprofileValue14	16, TBC	TBD		



Project Document

SPIRE Data ICD

Ref: SPIRE-RAL-PRJ-001078

Issue: Issue 2.0

Date: 15th November 2004

Page: 126 of 143

CHOPPROFILEVAL15	CprofileValue15	16, TBC	TBD		
CHOPS	ChopNumber	16			Number of Chop Cycles to perform
CHOPSENSPOSN1	CMagnetoResPos1	16, TBC	TBD		
CHOPSENSPOSN2	CMagnetoResPos2	16, TBC	TBD		
CHOPSENSPWR	SensorPwr	1	CHOPSENS		Chopper axis sensor power status
CHOPSTAT	ChopStatus	16, TBC	TBD		Contents of Chop Axis Activity Status Register
CHOPSTATECOEFF1	CStateCoeff1	16, TBC	TBD		
CHOPSTATECOEFF2	CStateCoeff2	16, TBC	TBD		
CHOPSTATECOEFF3	CStateCoeff3	16, TBC	TBD		
CHOPSTATECOEFF4	CStateCoeff4	16, TBC	TBD		
DAQBIAS5V	DcuDAQp05	TBD	TBD	TBD	Voltage to DAQ Board on +5V line
DAQ9V	DcuDAQp09	TBD	TBD	TBD	Voltage to DAQ Board on +9V line
DAQ9VN	DcuDAQn09	TBD	TBD	TBD	Voltage to DAQ Board on -9V line
DAQTEMP	DAQ_I/F_TEMP	8	TBD		DAQ I/F Board Temperature
DCUDATAFRMS	frame	8	DCUFRMS		Number of DCU data frames to generate
DCUDATAMODE	mode	5	DCUMODE		DCU data collection mode
DCUDATASTAT	start	1	DCUSTAT		Status of DCU data frame generation
DCUFLAGS		16			DCU Status -TBC
DCUTEMP	DcuTempRd	TBD	TBD	TBD	Temperature from sensor on Distribution Board
DPU5V		12	TBD		DPU +5V line voltage
DPU15V		12	TBD		DPU +15V line voltage
DPU15VN		12	TBD		DPU -15V line voltage
DPUI		12	TBD		DPU measured input current
DPU_Spare1		12	TBD		
DPU_Spare2		12	TBD		
DPU_Spare3		12	TBD		
DPUTEMP		12	TBD		DPU DC-DC Converter Temperature
JIGGKDHIGH	KdHigh	16, TBC			Maximum Derivative Gain of Chop Axis PID Controller?
JIGGKDLow	KdLow	16, TBC			Minimum Derivative Gain of Chop Axis PID Controller?
JIGGFILTHIGH	DerivFilterHigh	16, TBC			Filtering Time Constant to calculate the derivative term of the Chop PID Controller
JIGGFILTLOW	DerivFilterLow	16, TBC			Filtering Time Constant to calculate the derivative term of the Chop PID Controller



Project Document

SPIRE Data ICD

Ref: SPIRE-RAL-PRJ-001078
Issue: Issue 2.0
Date: 15th November 2004
Page: 127 of 143

JIGGKIHIGH	KiHigh	16, TBC			Maximum Integral Gain of Chop Axis PID Controller?
JIGGKILOW	KiLow	16, TBC			Minimum Integral Gain of Chop Axis PID Controller?
JIGGKPHIGH	KpHigh	16, TBC			Maximum Proportional Gain of Chop Axis PID Controller?
JIGGKFLOW	KpLow	16, TBC			Minimum Proportional Gain of Chop Axis PID Controller?
JIGGLATSTAT	JiggleLaunchLatch	1	LATCH		Jiggle Axis Launch Latch Status
JIGGLOOPMODE	JiggleLoopMode	2	JLOOPMODE		Jiggle Axis Loop Mode
JIGGMEANPERR	MeanPositionError	16, TBC			Mean Position Error over a Jiggle movement?
JIGGMODE	JiggleMode	2	JIGGMODE		Jiggling Mode
JIGGPERIOD	JigglePeriod	16, TBC	PERIOD		Jiggle Cycle Period – TBD if applicable
JIGGPERRLIM	PositionErrorLimit	16, TBC			Minimum Value of Chop Position Error that causes a PID error to be reported?
JIGGPOSN	ActualPosition	16, TBC			Last Absolute position of the Jiggle Axis
JIGGPOSN0	Position0	16, TBC			Jiggle Axis Position 0
JIGGPOSN1	Position1	16, TBC			Jiggle Axis Position 1 – TBD if applicable
JIGGLES	JiggleNumber	16, TBC			Number of Jiggle Cycles to perform – TBD if applicable
JIGGSATNLIM	IntegrationLimit	16, TBC			Integration Saturation Limit for the Chop PID Controller?
JIGGSENSPWR	SensorPwr	1	JIGGSENS		Jiggle Axis sensor power status
JIGGSTAT	JiggleStatus	16, TBC	TBD		Contents of Jiggle Axis Activity Status Register
LIA01TEMP	LIA_B1TEMP	8	TBD		LIA Board 1 Temperature
LIA02TEMP	LIA_B2_TEMP	8	TBD		LIA Board 2 Temperature
LIA03TEMP	LIA_B3_TEMP	8	TBD		LIA Board 3 Temperature
LIA04TEMP	LIA_B4_TEMP	8	TBD		LIA Board 4 Temperature
LIA05TEMP	LIA_B5_TEMP	8	TBD		LIA Board 5 Temperature
LIA06TEMP	LIA_B6_TEMP	8	TBD		LIA Board 6 Temperature
LIA07TEMP	LIA_B7_TEMP	8	TBD		LIA Board 7 Temperature
LIA08TEMP	LIA_B8_TEMP	8	TBD		LIA Board 8 Temperature
LIA09TEMP	LIA_B9_TEMP	8	TBD		LIA Board 9 Temperature
LIA10TEMP	LIA_B10_TEMP	8	TBD		LIA Board 10 Temperature
LIA11TEMP	LIA_B11_TEMP	8	TBD		LIA Board 11Temperature
LIA12TEMP	LIA_B12_TEMP	8	TBD		LIA Board 12 Temperature
MCUFLAGS		16			MCU Status -TBC
MCUTIMEOUT	DPU_PollingTime				Maximum Time between commands before an IO error is reported



Project Document

SPIRE Data ICD

Ref: SPIRE-RAL-PRJ-001078
Issue: Issue 2.0
Date: 15th November 2004
Page: 128 of 143

MCUTELSTAT	Telemetry	TBD	TBD		Define TM packets to be sent
MCUTELSAMP	TelemetrySampling	TBD	TBD		Sampling Rate of Telemetry Packets
MEMCHK		48	TBD		Memory Check Flags
MODE		16	TBD		Instrument Operating Mode
MONSTAT		16	MONSTAT		Subsystem Monitoring Status -- indicates if the subsystem is on/off
DCUMONSTAT		1			DCU Status (bit 0)
MCUMONSTAT		1			MCU Status (bit 1)
SCUMONSTAT		1			SCU Status (Bit 2)
OBSID		32			Observation ID
OBSLEN		32			Time since start of Observation (secs)
OTFERROR		16, TBC	TBD		On Target Flag Error
OTFTIME		48			On Target Flag Time
OTF		1	OTF		On Target Flag
PHOTBIAS9V	DcuBHP09	TBD	TBD	TBD	Voltage to Photometer Bias Board on +9V line
PHOTBIAS9VN	DcuBPHn09	TBD	TBD	TBD	Voltage to Photometer Bias Board on -9V line
PHOTBIASFREQ	Div_photo_bias	9	BIASFREQ		Photometry Bias frequency
PHOTBIASMODE	Mode_photo_bias	8	BIASMODE		Photometry bias generator mode
PHOTLIA5V	Dc uLPHp05	TBD	TBD	TBD	Voltage to Photometer LIA Board on +5V line
PHOTLIA9V	Dc uLPHp09	TBD	TBD	TBD	Voltage to Photometer LIA Board on +9V line
PHOTLIA9VN	Dc uLPHn09	TBD	TBD	TBD	Voltage to Photometer LIA Board on -9V line
PHOTSAMPFREQ	Div_photo_sampl	8	PSAMPFREQ		Photometry sampling frequency
PHTRV	Ampl_photo_heater	8	HTR		Voltage applied to photometer heaters
PLWBIAS	Ampl_P500	8	BIAS		Amplitude of bias for photometry long wave channels
PLWJFET1V	Ampl_P500_VSS1	8	JFETV		Voltage applied to JFET for photometry long wave channels (group1)
PLWJFET2V	Ampl_P500_VSS2	8	JFETV		Voltage applied to JFET for photometry long wave channels (group2)
PLWPHSE	Phase_shift_P500	8	PHASE		Phase shift for long wave photometry channels demodulation
PMLWJFETSTAT		6			
PMWJFET1STAT	P350_JFET_1	1	JFETSTAT		Status of JFET power for photometry medium wave channels (group1) (Bit 7)
PMWJFET2STAT	P350_JFET_2	1	JFETSTAT		Status of JFET power for photometry medium wave channels (group2) (Bit 6)
PMWJFET3STAT	P350_JFET_3	1	JFETSTAT		Status of JFET power for photometry medium wave channels (group3) (Bit 5)
PMWJFET4STAT	P350_JFET_4	1	JFETSTAT		Status of JFET power for photometry medium wave channels (group4) (Bit 4)
PLWJFET1STAT	P500_JFET_1	1	JFETSTAT		Status of JFET power for photometry long wave channels (group1) (Bit 3)
PLWJFET2STAT	P500_JFET_2	1	JFETSTAT		Status of JFET power for photometry long wave channels (group2) (Bit 2)



Project Document

SPIRE Data ICD

Ref: SPIRE-RAL-PRJ-001078

Issue: Issue 2.0

Date: 15th November 2004

Page: 129 of 143

PMWBIAS	Ampl_P350	8	BIAS		Amplitude of bias for photometry medium wave channels
PMWJFET1V	Ampl_P350_VSS1	8	JFETV		Voltage applied to JFET for photometry medium wave channels (group1)
PMWJFET2V	Ampl_P350_VSS2	8	JFETV		Voltage applied to JFET for photometry medium wave channels (group2)
PMWJFET3V	Ampl_P350_VSS3	8	JFETV		Voltage applied to JFET for photometry medium wave channels (group3)
PMWJFET4V	Ampl_P350_VSS4	8	JFETV		Voltage applied to JFET for photometry medium wave channels (group4)
PMWPHSE	Phase_shift_P350	8	PHASE		Phase shift for medium wave photometry channels demodulation
PSUTEMP	PsuTempRd	TBD	TBD	TBD	PSU Temperature Sensor reading
PSWBIAS	Ampl_P250	8	BIAS		Amplitude of bias for photometry short wave channels
PSWJFET1V	Ampl_P250_VSS1	8	JFETV		Voltage applied to JFET for photometry short wave channels (group1)
PSWJFET2V	Ampl_P250_VSS2	8	JFETV		Voltage applied to JFET for photometry short wave channels (group2)
PSWJFET3V	Ampl_P250_VSS3	8	JFETV		Voltage applied to JFET for photometry short wave channels (group3)
PSWJFET4V	Ampl_P250_VSS4	8	JFETV		Voltage applied to JFET for photometry short wave channels (group4)
PSWJFET5V	Ampl_P250_VSS5	8	JFETV		Voltage applied to JFET for photometry short wave channels (group5)
PSWJFET6V	Ampl_P250_VSS6	8	JFETV		Voltage applied to JFET for photometry short wave channels (group6)
PSWJFETSTAT		6			
PSWJFET1STAT	P250_JFET_1	1	JFETSTAT		Status of JFET power for photometry short wave channels (group1) (Bit 7)
PSWJFET2STAT	P250_JFET_2	1	JFETSTAT		Status of JFET power for photometry short wave channels (group2) (Bit 6)
PSWJFET3STAT	P250_JFET_3	1	JFETSTAT		Status of JFET power for photometry short wave channels (group3) (Bit 5)
PSWJFET4STAT	P250_JFET_4	1	JFETSTAT		Status of JFET power for photometry short wave channels (group4) (Bit 4)
PSWJFET5STAT	P250_JFET_5	1	JFETSTAT		Status of JFET power for photometry short wave channels (group5) (Bit 3)
PSWJFET6STAT	P250_JFET_6	1	JFETSTAT		Status of JFET power for photometry short wave channels (group6) (Bit 2)
PSWPHSE	Phase_shift_P250	8	PHASE		Phase shift for short wave photometry channels demodulation
RATE		32			Data Rate (average bits/sec over observation)
SCANMODE	ScanMode	2	SCANMODE		SMEC Scan Mode
SCANS	ScanNumber	16			Number of SMEC Scans to perform TBC
SCANSPEED	ScanSpeed	16			SMEC Scan Speed
SCANSTART	ScanStart	16			SMEC Scan Start Position
SCANSTAT	StartScan	1	SCANSTAT		SMEC Scan Status
SCU5V	ScuCHTp05	12, TBC	TBD		Voltage on SCU 5Vline
SCU9V	ScuCHTp09	12, TBC	TBD		Voltage on SCU+9Vline
SCU9VN	ScuCHTn09	12, TBC	TBD		Voltage on SCU -9Vline
SCUCAL1I	Calibra1I	12, TBC	TBD		Current in Calibrator 1
SCUCAL1V	CalibraV1	12, TBC	TBD		Voltage Applied to Calibrator 1



Project Document

SPIRE Data ICD

Ref: SPIRE-RAL-PRJ-001078
Issue: Issue 2.0
Date: 15th November 2004
Page: 130 of 143

SCUCAL2I	CalibraI2	12, TBC	TBD		Current in Calibrator 2
SCUCAL2V	CalibraV2	12, TBC	TBD		Voltage Applied to Calibrator 2
SCUCAL3I	CalibraI3	12, TBC	TBD		Current in Calibrator 3
SCUCAL3V	CalibraV3	12, TBC	TBD		Voltage Applied to Calibrator 3
SCUCMDSTAT		TBD	TBD		Command Interface Control Status Word - TBD
SCUDATAFREQ	FrameRate	16,TBC	TBD		Frame Rate
SCUDELAY	SubsDelay	16,TBC	TBD		Subsystem Response Time
SCUFLAGS		16			SCU Status -TBC
SCUFRAMES	SeqLength	16,TBC			Number of frames
SCUHHTRV	HheaterV1	12, TBC	TBD		Voltage Applied to High Power Heater
SCULHTR1V	LheaterV1	12, TBC	TBD		Voltage Applied to Low Power Heater1
SCULHTR2V	LheaterV2	12, TBC	TBD		Voltage Applied to Low Power Heater2
SCULHTR3V	LheaterV3	12, TBC	TBD		Voltage Applied to Low Power Heater3
SCUSTAT	DRelOnOff	8	TBD		Status of Distribution Board relays
SCUSUBKFREQ	SubKpRate	16,TBC	TBD		Sampling Rate of SubK temperatures
SCUSUBSSTAT	SubStatus	TBD	TBD		Subsystem Status
SCUTEMPSTAT	TempOnOff	12	TBD		Power on status of temperature probes
Allocation of bits TBD					
SHTRV	Ampl_spectro_heater	8	HTR		Voltage applied to spectrometer heaters
SJFETSTAT		6			
SLWJFET1STAT	S-LW_JFET_1	1	JFETSTAT		Status of JFET power for spectrometry long wave channels (Bit 7)
SSWJFET1STAT	S-SW_JFET_1	1	JFETSTAT		Status of JFET power for spectrometry short wave channels (group1) (Bit 6)
SSWJFET2STAT	S-SW_JFET_2	1	JFETSTAT		Status of JFET power for spectrometry short wave channels (group2) (Bit 5)
SLWBIAS	Ampl_S-LW	8	BIAS		Amplitude of bias for spectrometry long wave channels
SLWJFET1V	Ampl_S-LW_VSS1	8	JFETV		Voltage applied to JFET for spectrometry long wave channels
SLWPHSE	Phase_shift_S-LW	8	PHASE		Phase shift for long wave spectrometry channels demodulation
SMECOENCPWR	EncoderPwr	3	TBD		SMEC Optical Encoder LED power
SMECFILTHIGH	DerivFilterHigh	16,TBC			Filtering Time Constant to calculate the derivative term of the SMEC PID Controller
SMECFILTLOW	DerivFilterLow	16,TBC			Filtering Time Constant to calculate the derivative term of the SMEC PID Controller
SMECSATNLIM	IntegrationLimit	16,TBC			Integration Saturation Limit for the SMEC PID Controller?
SMECINITSTAT		TBD			Initialisation Status of SMEC



Project Document

SPIRE Data ICD

Ref: SPIRE-RAL-PRJ-001078
Issue: Issue 2.0
Date: 15th November 2004
Page: 131 of 143

SMECKDHIGH	KdHigh	16,TBC			Maximum Derivative Gain of SMEC PID Controller?
SMECKDLOW	KdLow	16,TBC			Minimum Derivative Gain of SMEC PID Controller?
SMECKIHIGH	KiHigh	16,TBC			Maximum Integral Gain of SMEC PID Controller?
SMECKILOW	KiLow	16,TBC			Minimum Integral Gain of SMEC PID Controller?
SMECKPHIGH	KpHigh	16,TBC			Maximum Proportional Gain of SMEC PID Controller?
SMECKPLOW	KpLow	16,TBC			Maximum Proportional Gain of SMEC PID Controller?
SMECLAT1STAT	LaunchLatch1	1	LATCH		SMEC Launch Latch1 Status
SMECLAT2STAT	LaunchLatch2	1	LATCH		SMEC Launch Latch2 Status
SMECLOOPMODE	LoopMode	2	LOOPMODE		SMEC Control Loop Mode
SMECLVDTPWR	LVDTPwr	1	TBD		SMEC LVDT Oscillator On/Off
SMECMEANPERR	MeanPositionError	16,TBC	TBD		Mean SMEC Position Error over scan
SMECMEANVEL	MeanSpeed	16,TBC	TBD		Mean SMEC Speed over scan
SMECNOTCHHIGH	NotchParamHigh	16,TBC			TBW
SMECNOTCHLOW	NotchParamLow	16,TBC			TBW
SMECPOSN	ActualPosition	16,TBC			Last Absolute position of the SMEC
SMECPERRLIM	PositionErrorLimit	16,TBC			Minimum Value of SMEC Position Error that causes a PID error to be reported?
SMECSTAT	SmecStatus	16,TBC	TBD		Contents of SMEC Activity Status Register
SMECVEL	ActualVelocity	16,TBC			Instantaneous Velocity (20Hz filtered) of the SMEC
SPECBIAS9V	DcuBSPp09	TBD	TBD	TBD	Voltage to Spectrometer Bias Board on +9V line
SPECBIAS9VN	DcuBSPn09	TBD	TBD	TBD	Voltage to Spectrometer Bias Board on -9V line
SPECBIASFREQ	Div_spectro_bias	9	BIASFREQ		Spectrometry Bias frequency
SPECBIASMODE	Mode_spectro_bias	8	BIASMODE		Spectrometry bias generator mode
SPECLIA5V	DcuLSPp05	TBD	TBD	TBD	Voltage to Spectrometer LIA Board on +5V line
SPECLIA9V	DcuLSPp09	TBD	TBD	TBD	Voltage to Spectrometer LIA Board on +9V line
SPECLIA9VN	DcuLSPn09	TBD	TBD	TBD	Voltage to Spectrometer LIA Board on -9V line
SPECSAMPFREQ	Div_spectro_sampl	8	SSAMPFREQ		Spectrometry sampling frequency
SSWBIAS	Ampl_S-SW	8	BIAS		Amplitude of bias for spectrometry short wave channels
SSWJFET1V	Ampl_S-SW_VSS1	8	JFETV		Voltage applied to JFET for spectrometry short wave channels (group1)
SSWJFET2V	Ampl_S-SW_VSS2	8	JFETV		Voltage applied to JFET for spectrometry short wave channels (group2)
SSWPHSE	Phase_shift_S-SW	8	PHASE		Phase shift for short wave spectrometry channels demodulation
STEP		16			Number of current step in an observation



Project Document

SPIRE Data ICD

Ref: SPIRE-RAL-PRJ-001078
Issue: Issue 2.0
Date: 15th November 2004
Page: 132 of 143

SUBKTEMP	SubKTempP	TBD	TBD	TBD	Temperature from SubK temperature probe
TRACEPERIOD	TraceSampling		PERIOD		Time period between successive Trace Values
TRACESIZE	TraceBuffer	16, TBC			Trace Buffer Size
TRACEPARAM1	TraceParam#1	TBD			Trace Parameter 1
TRACEPARAM2	TraceParam#2	TBD			Trace Parameter 2
TRACEPARAM3	TraceParam#3	TBD			Trace Parameter 3
TRACEPARAM4	TraceParam#4	TBD			Trace Parameter 4
TRACEPARAM5	TraceParam#5	TBD			Trace Parameter 5
TRACEPARAM6	TraceParam#6	TBD			Trace Parameter 6
TC1TEMP	T/C1	20	TBD		Thermal Control Thermistor #1 value
TC2TEMP	T/C2	20	TBD		Thermal Control Thermistor #2 value
TC3TEMP	T/C3	20	TBD		Thermal Control Thermistor #3 value
TCBIAS	Ampl_T/C	8	BIAS		Amplitude of bias for thermal control channels
TCEXEC		16			Number of telecommand packets executed since switch on
TCEXEN		16			Sequence Control word of last executed telecommand packet
TCPHSE	Phase_shift_T/C	8	PHASE		Phase shift for thermal control channels demodulation
TCRECN		16			Sequence Control word of last received telecommand packet
TCRECV		16			Number of telecommand packets received since start of the OBS application. Commands to the Boot SW are not included
TCUTEMP	TcuTempRd	TBD	TBD	TBD	Temperature from sensor on Temp Board
TDPU		48			Local DPU On Board Time
TEMP01	FpuTemp01	TBD	TBD	TBD	To be replaced by correct name
TEMP02	FpuTemp02	TBD	TBD	TBD	To be replaced by correct name
TEMP03	FpuTemp03	TBD	TBD	TBD	To be replaced by correct name
TEMP04	FpuTemp04	TBD	TBD	TBD	To be replaced by correct name
TEMP05	FpuTemp05	TBD	TBD	TBD	To be replaced by correct name
TEMP06	FpuTemp06	TBD	TBD	TBD	To be replaced by correct name
TEMP07	FpuTemp07	TBD	TBD	TBD	To be replaced by correct name
TEMP08	FpuTemp08	TBD	TBD	TBD	To be replaced by correct name
TEMP09	FpuTemp09	TBD	TBD	TBD	To be replaced by correct name
TEMP10	FpuTemp10	TBD	TBD	TBD	To be replaced by correct name
TEMP11	FpuTemp11	TBD	TBD	TBD	To be replaced by correct name



Project Document

SPIRE Data ICD

Ref: SPIRE-RAL-PRJ-001078
Issue: Issue 2.0
Date: 15th November 2004
Page: 133 of 143

TEMP12	FpuTemp12	TBD	TBD	TBD	To be replaced by correct name
TEMP13	FpuTemp13	TBD	TBD	TBD	To be replaced by correct name
TEMP14	FpuTemp14	TBD	TBD	TBD	To be replaced by correct name
TEMP15	FpuTemp15	TBD	TBD	TBD	To be replaced by correct name
TEMP16	FpuTemp16	TBD	TBD	TBD	To be replaced by correct name
THSK		48			DPU Time of start of last housekeeping data collection period
TSFTIME		48			Telescope Scan Time
TSF		1	TSF		Telescope Scan Flag
TSYNC		48			DPU Time of last DRCU Synchronisation
SCUSPARE	Reserved	TBD			



5.2.2 Conversion Curves

Name	Type	Raw Value	Converted Value	Units	Comments
BIAS	Analogue	0 255	0.0 Vbmax	Volts	$Eng = \frac{Vb\ max* Raw}{255}$
BIASFREQ	Derived Calculated	Raw	Eng	Hz	$Eng = \frac{TBD\ MHz}{2 * Raw}$
BIASMODE	Enumerated	0c00 0x01 0x02 0xFD 0xFE 0xFF	OFF DC001 DC002 DC253 DC252 SINE		Values 0x01 to 0xFE are test levels
CHOPMODE	Enumerated	0 1 2	STOP STEP TOGGLE		Chopping Stopped Chopping in step mode Chopping in toggle mode
CHOPSENS	Enumerated	0 1	ON OFF		Values TBC
CLOOPMODE	Enumerated	0 1 2	OPEN BEMF SENS		Loop Open Loop closed using Back EMF Loop Closed using Magnetoresistive Sensor
DCUFRMS	Enumerated	0 1 2 254 255	CONT. 1 2 254 255		



Project Document

SPIRE Data ICD

Ref: SPIRE-RAL-PRJ-001078

Issue: Issue 2.0

Date: 15th November 2004

Page: 135 of 143

DCUMODE	Enumerated	0x00 0x01 0x02 0x03 0x04 0x05 0x06 0x08 0x0C 0x10 0x14 0x18 0x1C	PHOT PSW PMW PLW SPEC SSW SLW PTEST STEST POFFSET SOFFSET POFFGET SOFFGET		
DCUSTAT	Enumerated	0 1	OFF RUN		
HTR	Analogue	0 255	0.0 Vhmax	Volts	$Eng = \frac{Vh \max * Raw}{255}$
JFETSTAT	Enumerated	0 1	OFF ON		
JFETV	Analogue	0 255	0.0 VSSmax	Volts	$Eng = \frac{VSS \max * Raw}{255}$
JIGGLEMODE	Enumerated	0 1 2	STOP STEP TOGGLE		Jiggling Stopped Jiggling in step mode Jiggling in toggle mode - TBD if applicable
JIGGLESENS	Enumerated	0 1	ON OFF		Values TBC
JLOOPMODE	Enumerated	0 1 2	OPEN BEMF SENS		Loop Open Loop closed using Back EMF Loop Closed using Magnetoresistive Sensor
LATCH	Enumerated	0 1	Engaged Disengaged		Values TBC
LOOPMODE	Enumerated	0	OPEN		Loop Open



Project Document

SPIRE Data ICD

Ref: SPIRE-RAL-PRJ-001078

Issue: Issue 2.0

Date: 15th November 2004

Page: 136 of 143

		1	BEMF		Loop closed using Back EMF
		2	LVDT		Loop Closed using LVDT
		3	OENC		Loop Closed using Optical Encoder
MONSTAT	Enumerated	0	OFF		Subsystem off
		1	ON		Subsystem on
OTF	Enumerated	0	Off Target		
		1	On Target		
PERIOD				mS	
PHASE	Analogue	0 255	0 360	Degrees	$Eng = \frac{360 * Raw}{255}$
PSAMPFREQ	Derived Calculated	<i>Raw</i>	<i>Eng</i>	Hz	$Eng = \frac{PHOTBIASFREQ * Eng}{2 * Raw}$
SCANMODE	Enumerated	0 1 2 3	STOP STEP SAWTOOTH TRIANGLE		
SCANSTAT	Enumerated	0 1	STOP RUN		
SSAMPFREQ	Derived Calculated	<i>Raw</i>	<i>Eng</i>	Hz	$Eng = \frac{SPECBIASFREQ * Eng}{2 * Raw}$
TSF	Enumerated	2 3	Scanning Pointing		

5.2.3 Constraints



Appendix A

This section describes the use of the On Board Software (OBS) commands and telemetry in sufficient detail that the interface can be understood.

6. TABLES

Much of the data used by the OBS for operations will be held in tables. These will be used to hold, for example:

- Housekeeping packet parameter lists
- Jiggle position tables
- Command Lists

The OBS will provide for the definition of up to 128 tables, within a fixed-size memory area and will automatically move data within this memory area in order to allow update of tables, including a change in size.

By default the following table numbers are assigned and populated in the OBS, though they may be changed by command:

Table ID	Description
00	Critical Housekeeping Report Definition
01	Nominal Housekeeping Report Definition
02	undefined
03	undefined
21	Cooler Recycle
22	Cooler Temperature Control
23	300mK Temperature Control
24	SCAL Temperature Control
31	CHOP
32	SCAN
100	Functions

All tables are accessed using a Table_ID and individual locations in the table are accessed by an index, specified as a number of words, offset from the beginning of the table. The word size is 32bits.



Appendix B

7. CONTROL LOOPS

Several control loops are executed by the On-board Software. These are all implemented as PID (Proportional, Integral, Differential) control algorithms, where the control variable (C) is adjusted to maintain the measurement variable (M) at the set point (S). The equation giving this relationship is

$$C_N = C_{N-1} + K_P * (S - M_N) + K_I * \left(S - \frac{\sum_{i=N-n}^{i=N} M_i}{n+1} \right) + K_D * (M_N - M_{N-1})$$

Where:

C_N = Control variable value for sample period N

M_N = Measurement Variable value at sample N

S = Required Set Point of the measurement variable

K_P = Proportional Gain

K_I = Integral Gain

K_D = Differential Gain

n = number of samples in the integral

7.1 Control Loop Parameters

When starting the control loop the following parameters have to be provided

- S = Required Set Point of the measurement variable
- K_P = Proportional Gain
- K_I = Integral Gain
- K_D = Differential Gain
- n = number of samples in the integral (max 32, TBC)
- dt = the time interval between samples
- P_M = The housekeeping parameter to use as the measurement variable
- P_C = The housekeeping parameter to use as the control variable

It is expected that the software shall maintain a buffer containing the last n samples in order to calculate the integral term for each sample period.

If the accuracy of the measurement sampling interval cannot be guaranteed, the software will also need to maintain a buffer containing the time of each of the n samples in order to make a more accurate estimate of the integral and differential terms (the equation above assumes a fixed sampling period).

The software must ensure that the accuracy of the calculation is adequate (e.g. by use of floating point, or fixed point, math functions)



Appendix C

8. COMMAND LIST

This section (TBW) defines the command list entries that are available.

9.2 Photometer MW

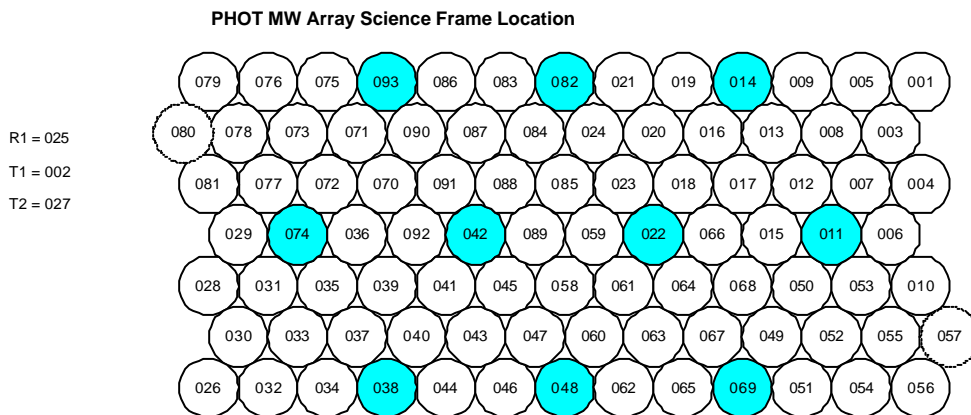
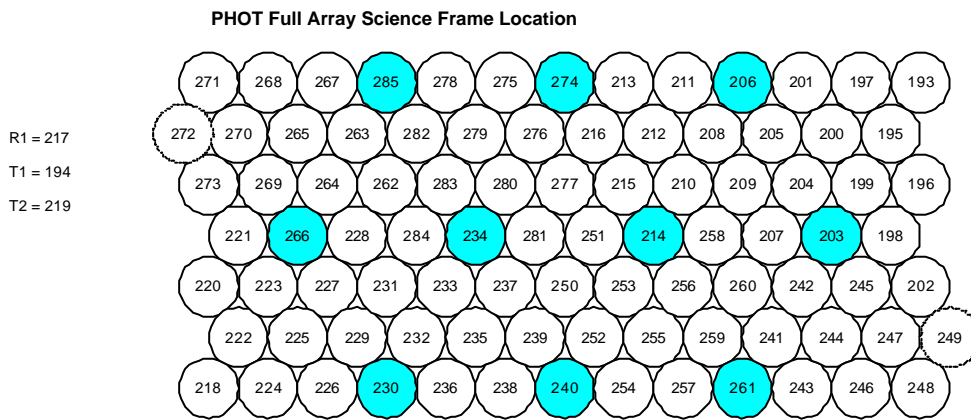
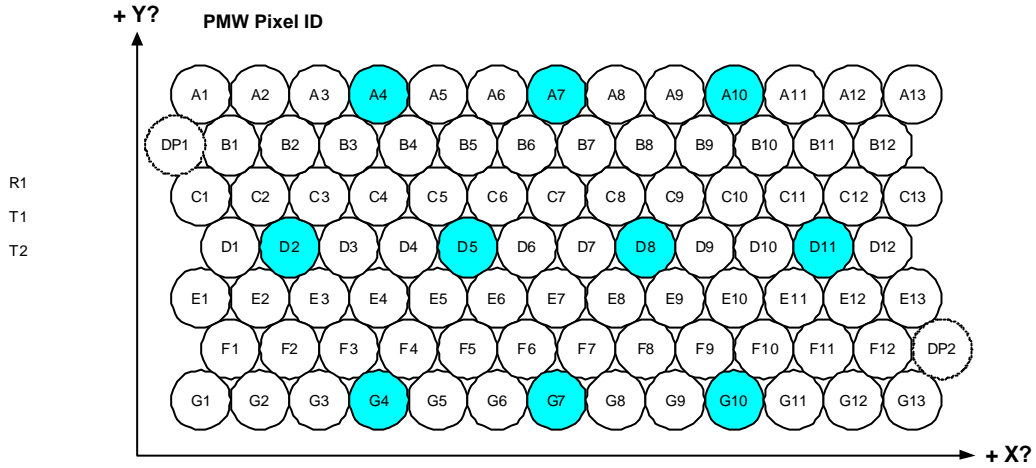

9.3 Photometer LW

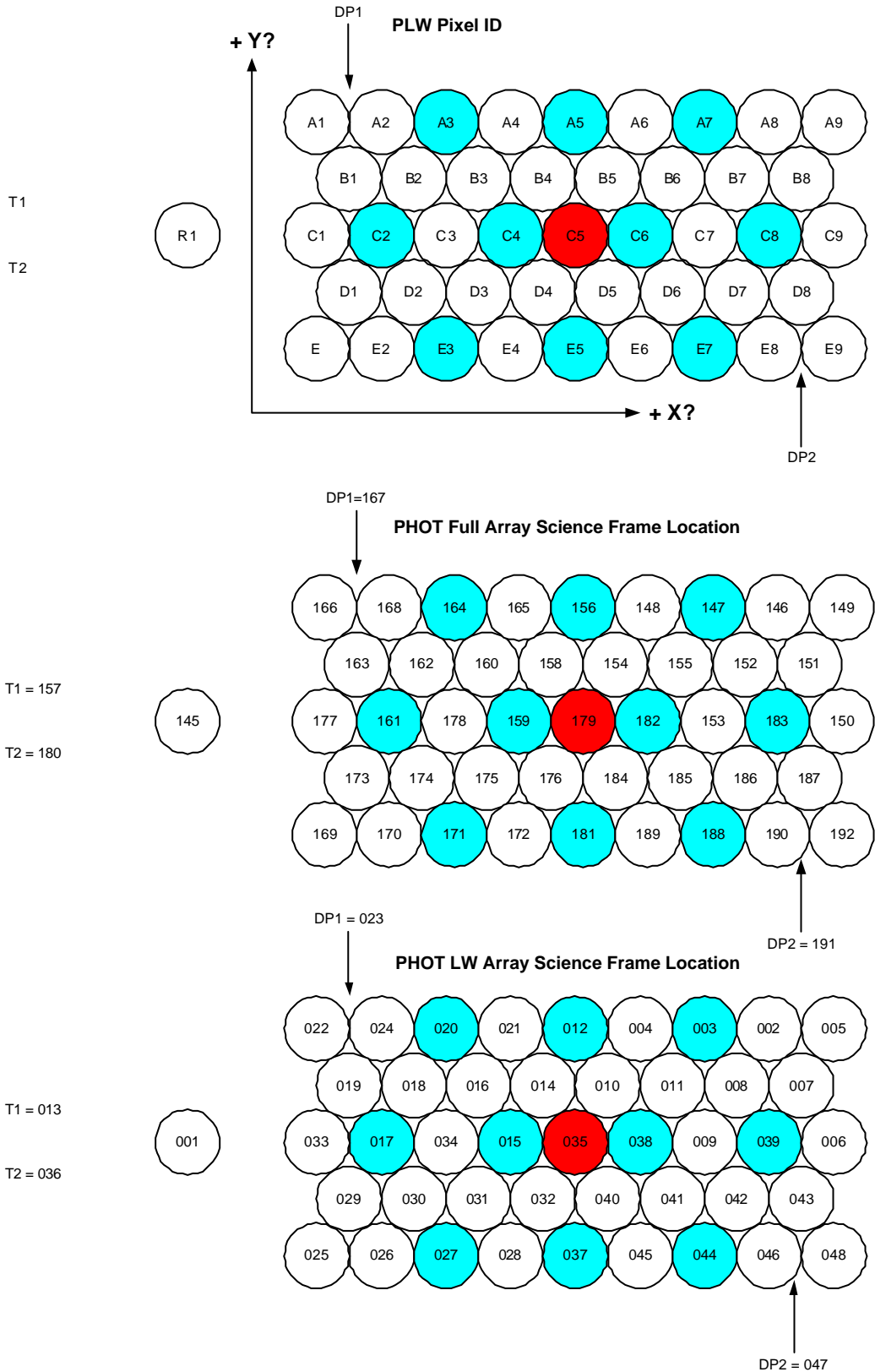

9.4 Spectrometer SW

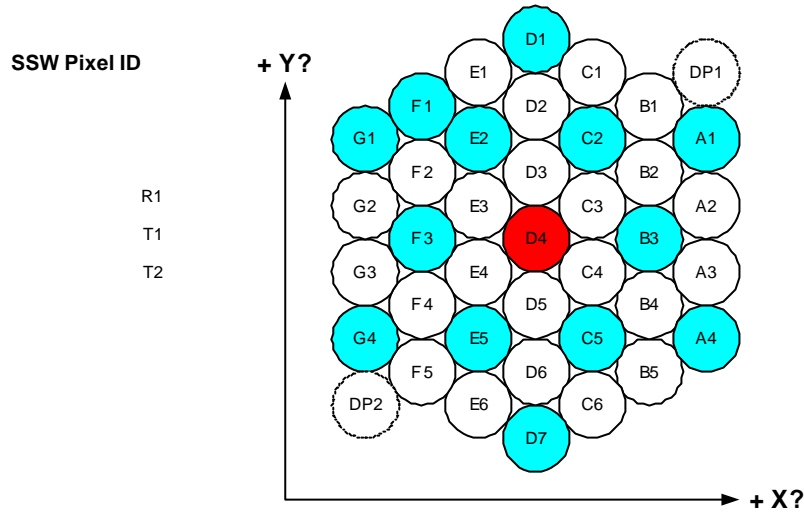

**SPEC Full Array
Science Frame
Location**

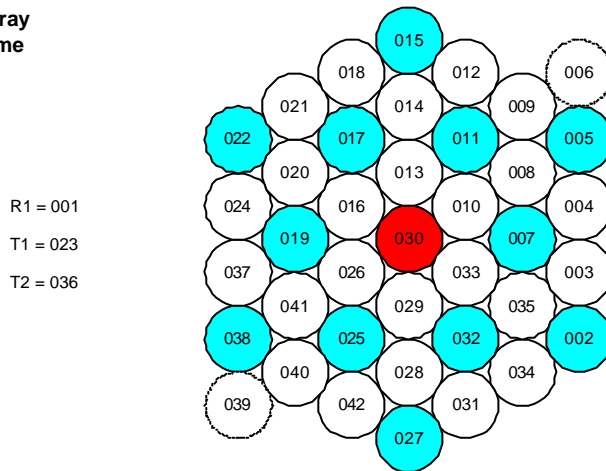

**SPEC SW Array
Science Frame
Location**

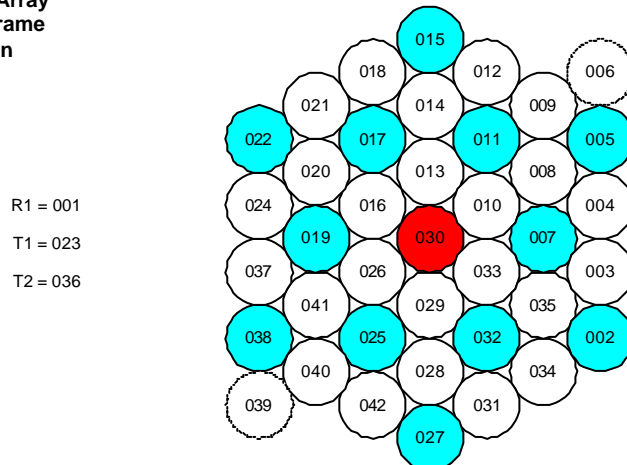

9.5 Spectrometer LW

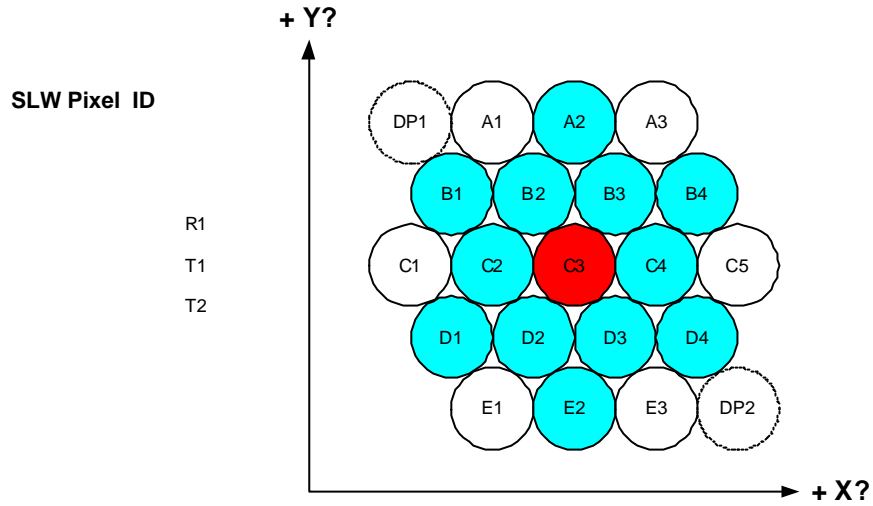

**SPEC Full Array
Science Frame
Location**

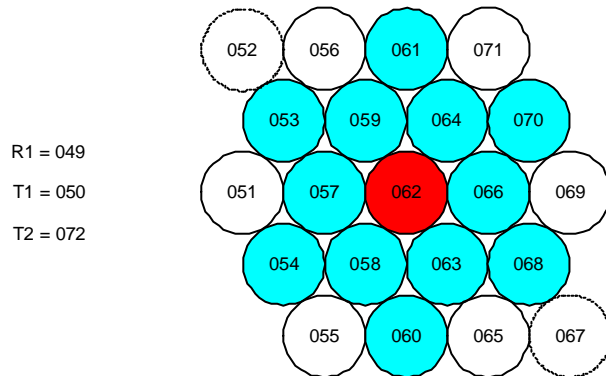

**SPEC LW Array
Science Frame
Location**

