

000134

3/7/97

1 Note

Fax

2nd

Andy Robson
Otto H. Bauer
K. King
P. Roelfema
A. Schmitz

FIRST/ESA/N/0011.02

FINDAS
Preliminary Data Model

July 2, 1997

FIRST

FINDAS

Contents

1 Introduction	4
2 Acronyms	6
3 Glossary	7
4 Ground segment	8
4.1 Instrument Level Development and Tests	9
4.2 Check-Out Phase	10
4.3 Mission Phase	10
4.4 Post Mission Operations	13
4.5 Active Archive Phase	14
5 Instrument Level Development and Test	16
6 Check-out	18
7 Mission preparations	19
8 Mission operations	21
9 Post mission	24
10 Active Archive	26
11 Roles and type of users	27
11.1 Common aspects	27
11.2 Expert users	28
11.3 Observers	28
11.4 Final note	29
12 Project guidelines	30
13 Review	31
13.1 Observation, calibration, ToO	31
13.2 Other data	32
14 A possible data structure	34
14.1 Top level	34
14.2 Schedule	34
14.3 Scheduling Unit	34
14.4 AOT	35
14.5 Instrument	35
 Preliminary data model	 DRAFT
	1

FIRST

FINDAS

15 Data management	37
15.1 Configuration control	37
15.2 Group, users and rights	38
A Data components	40
A.1 Archive catalog	40
A.2 Satellite data	40
A.3 Satellite and instrument database	41
A.4 Operations planning data	42
A.5 Calibration data	42
A.6 Operations plans, procedures and software	43
A.7 Administrative data	43
A.8 Auxiliary science data	44
A.9 Software and tools	44

FIRST

FINDAS

List of Figures

1	The FIRST/PLANCK ground segment	8
2	ILF ground segment configuration	9
3	Check-out ground segment configuration	10
4	Mission preparations ground segment configuration	11
5	Mission operations ground segment configuration	12
6	Post mission operations ground segment configuration	13
7	Active archive ground segment configuration	14
8	Instrument and spacecraft development	16
9	Instrument and spacecraft development data flow	17
10	Check-out	18
11	Check-out data flow	18
12	Mission preparations	19
13	Mission preparations data flow	19
14	Mission operations	21
15	The mission operations phase ground segment	22
16	Mission operations data flow	23
17	Post mission	24
18	Post mission data flow	25
19	Active archive	26
20	Observation, calibration, ToO	31
21	Scheduling Unit	33
22	Configuration control state diagram	37
23	Groups, users and rights diagram	38

Preliminary data model

DRAFT

3

1 Introduction

This document supplements the information provided in the Statement of Work and related Reference Documents. It shows the role of FINDAS, and its interaction with the other elements of the FIRST/PLANCK Ground Segment, in the various phases of the FIRST/PLANCK project.

It identifies the major data items generated and manipulated by the Ground Segment in these phases, and provide, for each phase, a high level description of the overall flow of data and their relationship with FINDAS.

It is important to realise that the number, complexity and volume of the data entities generated and manipulated by the Ground Segment, as well as the number of interfaces to FINDAS will steadily increase from the set of basic components handled at Instrument Level Test (see section 4.1) to reach a peak during the operations phase (see section 4.3.2), and then start to decrease until the model in the Active Archive phase (see section 4.5) becomes quite simple. Yet the basic FINDAS functionality (communication, data storage and retrieval, support to various categories of users, configuration control, etc.) will be present (at various levels of sophistication) in all phases. The overall data model which underlies the FINDAS architecture should therefore be consistent, extensible and resilient to changes and additions.

FINDAS will have to evolve and adapt throughout its lifetime but the transition from one phase of the project to the next, shall be as smooth as possible. The system shall provide continuity to its users. In particular it should never be necessary to re-enter/re-generate data which have been produced during one phase (e.g. ILT see section 4.1) in order to be able to use them in a subsequent phase (e.g. Check-out see section 4.2).

The overriding requirement underlying the FIRST (and PLANCK) operations concepts is to maximize the overall scientific return, while minimizing the complexity and cost of the overall operations. The overall system shall allow selection of the optimal balance between the observation of various types of objects and use of the instruments. FINDAS shall promote these objectives.

In order to fill-in an observation request a user will have to access and manipulate several distinct data items (e.g. observation form, general descriptive documentation on spacecraft and instruments, various software tools such as "exposure" time calculator, possibly instrument simulator, astronomical catalogues, etc.). Once the observation has been carried out, the user will have to access his observation's data, and auxiliary/ancillary associated information, as well as scientific processing software and calibration data in order to perform his data analysis. FINDAS shall make these standard operations, easy, safe and efficient.

It must be taken into account that the basic model presented here as a starting point is an over-simplification of the overall complex set of data and relationships which need to be handled in the full blown version of FINDAS. The model in this simplified form must however be set up in such a way that extensions to

FIRST FINDAS Introduction

include additional data sets and relationships can be performed without major disruptions/re-design of the basic model.

Preliminary data model

DRAFT

5

FIRST FINDAS Acronyms

2 Acronyms

AO Announcement of Opportunity
AOT Astronomical Observation Template
CCE Central Check out Equipment
DPC Data Processing Centre
ESA European Space Agency
FINDAS FIRST Integrated Network And Data Archive System
FIRST Far Infra-Red and Sub-millimeter Telescope
FITS Flexible Image Transport System
FM Flight Model
FOT FIRST Operations Team
FOTAC FIRST Observation Time Allocation Committee
FSC FIRST Science Centre
FSODG FIRST Science Operations Definition Group
FST FIRST Science Team
ICC Instrument Control Centre
ILT Instrument Level Tests
MCC Mission Control Centre
MOC Mission Operations Centre
PI Principal Investigator
ST Satellite Template
STM Structural and Thermal Model
SU Scheduling Unit
TBC To Be Confirmed
TC Telecommands
TM Telemetry

FIRST FINDAS Glossary

ToO Target of Opportunity

WWW World Wide Web

3 Glossary

AOT An Astronomical Observation Template is a "definition" of an observational mode of one instrument. The design of these AOT's is primarily driven by the scientific use of the mode. An observer specifies the details of a proposal by filling a set of AOT's.

Calibration A calibration is a procedure to characterize a spacecraft, a spacecraft sub-system or an instrument. The result of the calibration is represented by a data set.

Downlink Downlink includes all the data and processes necessary to support the activities taking place after the actual execution of an observation.

Uplink Uplink includes all the data and processes necessary to support the activities taking place up to the actual execution of an observation.

Preliminary data model

DRAFT

7

FIRST

FINDAS

Ground segment

4 Ground segment

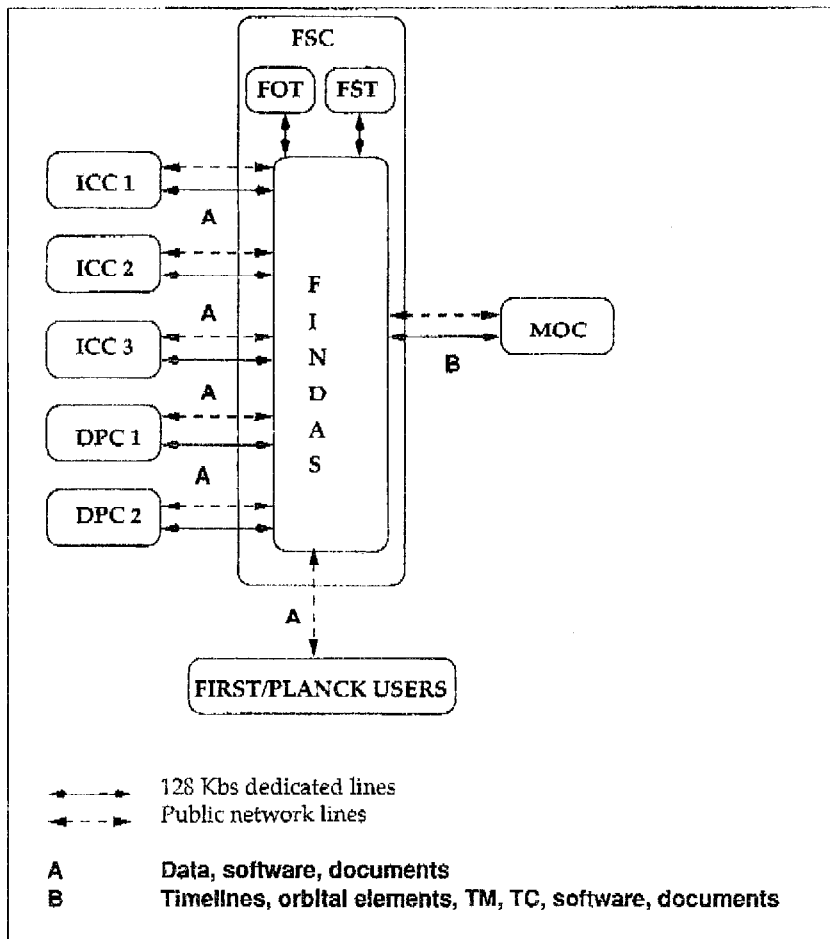

Figure 1: The FIRST/PLANCK ground segment

Figure 1 provides a high level picture of the overall FIRST/PLANCK Ground Segment. (Please note that Figure 1 replaces the corresponding Figure 1 in the SOW). The functional elements (FSC, ICCs and MOC) are as described in RD1 of the SOW.

In order to provide an overall picture, the Data Processing Centres (DPCs)

FIRST

FINDAS

Ground segment

associated with the PLANCK mode of operations are represented in Fig. 1. The DPCs are no longer mentioned in the subsequent chapters, since the overall PLANCK data model is not yet defined, and since it is a basic assumption that handling of the PLANCK data will not require any additional FINDAS functionality, in excess of what is required for FIRST.

In addition to FINDAS which constitutes the backbone of the overall FIRST/PLANCK Ground Segment and whose design, implementation, operations and maintenance is an FSC responsibility, the FSC houses two functional units: (1) the FIRST Operations Team (FOT) which carries out the tasks of Proposal Handling and Mission Planning, and (2) the FIRST Science Team (FST) who ensures overall science coordination, and the interface with the scientific community (general observers and FOTAC). Both FOT and FST are users of FINDAS.

Chapter 4.6 in RD1 of the SOW identifies the major mission phases seen from an operations point of view. For the purpose of FINDAS it is more appropriate to define corresponding phases seen from a design and implementation point a view. The following phases are identified:

4.1 Instrument Level Development and Tests

This phase starts with the selection of the scientific instruments (and associated ICCs) following the evaluation by ESA of the proposals received in response to the Announcement of Opportunity (AO). Current planned date is June 1998. It corresponds to activities performed in the instrument laboratories (and/or ICCs for the instrument level tests -ILT-). It normally ends when all instrument models have been delivered to ESA. This phase, therefore, overlaps considerably with the following phases. The basic Ground Segment configuration corresponding to the Instrument Level Development and Test phase is shown on Fig. 2.

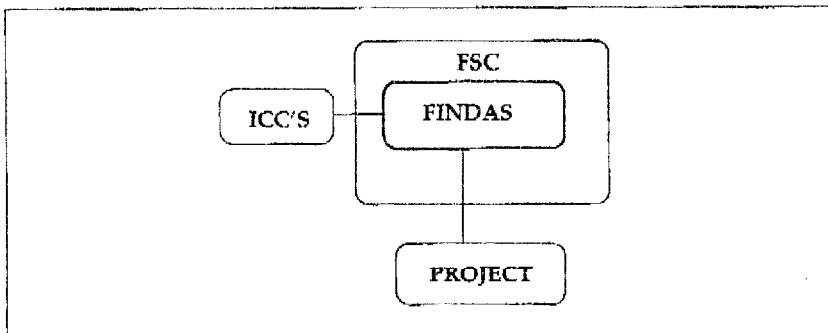

Figure 2: ILI ground segment configuration

The "Project" appears in this phase as provider of general spacecraft/mission

FIRST

FINDAS

Ground segment

documentation. This documentation shall be accessible to the authorized "users" via FINDAS. In this phase the "users" are primarily PI- and ICC- team personal. The facilities provided shall be such that "Project" personal can easily access, update (when required) and deposit the relevant documentation into FINDAS. Conversely access (of the latest version!) by PI- and ICC-team personal shall be straightforward.

In this phase FOT, FST and Observers are not involved. Data items and data flows relevant to this phase are described in more detail in chapter 5.

4.2 Check-Out Phase

Throughout this phase several Integration and System Level Tests with the various spacecraft and instruments models are foreseen. This phase normally starts with the System Structural and Thermal Model (STM) System Test, currently planned for early-2003, and ends with the Launch Campaign activities for the Flight Model (FM). The configuration shown in Fig. 2 is augmented by the ESA-provided Central Check-out Equipment (CCE) (see Fig. 3). The spacecraft located at the Test Facility is connected to the Ground Segment via the CCE.

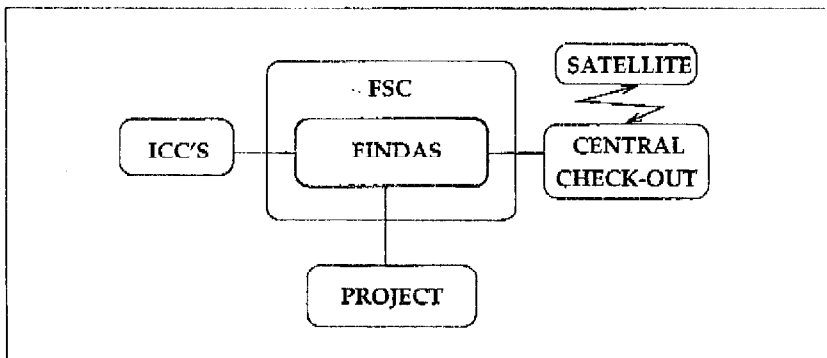

Figure 3: Check-out ground segment configuration

The "Project" role w.r.t. FINDAS is as defined in section 4.1. In this phase FOT, FST and Observers are not involved. Data items and data flows relevant to this phase are described in more detail in chapter 6.

4.3 Mission Phase

This phase is subdivided into two sub-phases: Mission Preparations and Operations.

4.3.1 Mission Preparations

This phase starts as soon as the first elements of the Ground Segment are established. It will, therefore, run largely in parallel with the previous phases but the emphasis is different. The phases described under sections 4.1 and 4.2 aim essentially at designing, building, integrating and testing the spacecraft and its payload of scientific instruments. The purpose of the Mission Preparations Phase is to design, build, integrate and test the Ground Segment which will support the operations of the spacecraft and its payload. It includes the building up and training of the operations teams. It culminates with the End-to-End Tests and Simulations to validate the entire Ground Segment (software, hardware, operations procedures and personal).

It is a fundamental design feature of the FIRST/PLANCK mission that commonality between the activities carried out during Instrument Development and Testing, Check-out and Mission Preparations is exploited to the maximum extent possible. This is true for the software tools, hardware elements, tests sequences/procedures, etc. As far as possible commonality between the instruments (w.r.t. definition of operating modes, commanding scheme, on-board memory management, etc.) will be maximized. The FINDAS data model shall support this double level of commonality.

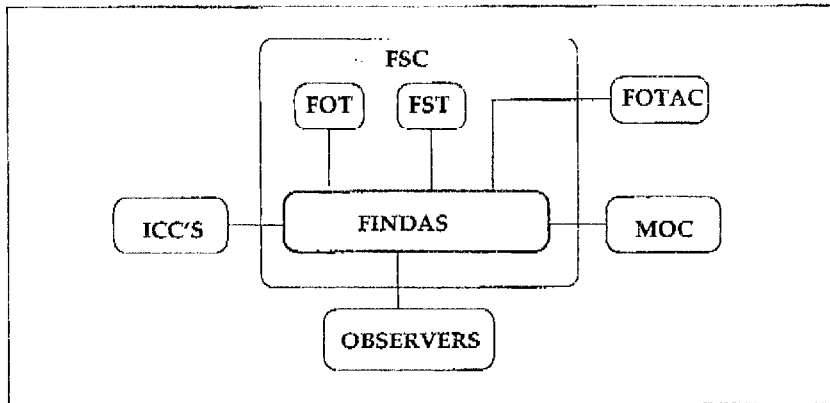

Figure 4: Mission preparations ground segment configuration

Fig. 4 shows the basic Ground Segment configuration corresponding to the Mission Preparations phase. Here the MOC replaces the CCE (compared with Fig. 3) but the interfaces to the other elements of the ground segment should remain identical.

In this configuration the real spacecraft and its payload in Fig. 3 is replaced (when appropriate) by the spacecraft/instrument simulator(s).

FIRST

FINDAS

Ground segment

The "Project" role w.r.t. FINDAS is as defined in section 4.1.

In this phase FOT, FST and Observers are involved. The Observers will use the software tools and documentation made available via FINDAS to register with the FSC and generate their observation proposals. The FOTAC is involved in proposal evaluation, grading and allocation of mission time to the successful observers. It uses the relevant tools and documentation made available via FINDAS.

Data items and data flows relevant to this phase are described in more detail in chapter 7.

4.3.2 Operations

This phase starts a few hours prior to lift-off and terminates when the orbital operations are discontinued (in principle after Helium boil-off).

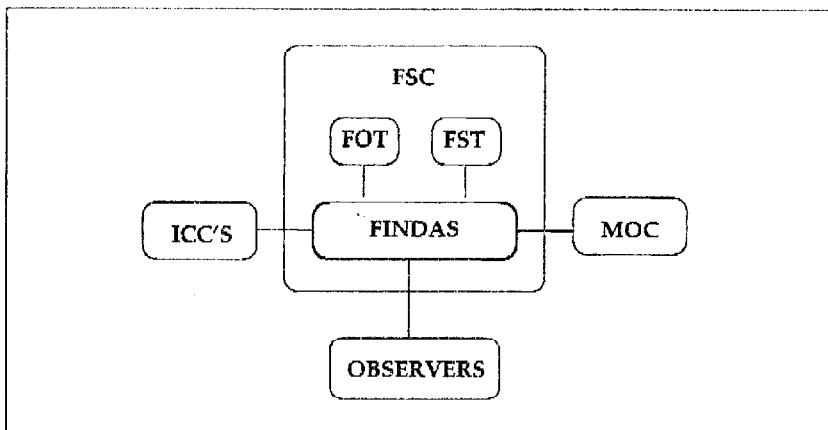

Figure 5: Mission operations ground segment configuration

The Ground Segment configuration for this phase is identical to the configuration depicted in Fig. 4. Note that the FOTAC is not involved in the "Operations" per se. However, the mission preparations activities continue to be carried out concurrently with the operations phase. It is planned to issue a "Call for Observing Proposals" every 9-to-12 months. Preparations for Call # 2 and handling of the corresponding proposals (involving FOTAC) will therefore take place concurrently with the operations related to Call # 1, etc. The FINDAS data model must support this concurrency.

As in the previous phase some of the Observers will generate proposals. (Calls # 2, 3, etc.) while others will at the same time interface with FINDAS in order to process the results of their observations.

FIRST

FINDAS

Ground segment

A couple of months/weeks after the start of the Operations phase the "Project" ceases to be active. The FOT/FST and possibly (selected) Observers will however continue to issue newsletters, publications, etc. which must be available to the scientific community. The facilities required from FINDAS to support these activities are identical to the facilities needed to carry out the "Project" activities described under section 4.1.

Data items and data flows relevant to this phase are described in more detail in chapter 8.

4.4 Post Mission Operations

This phase starts at the end of the operations phase. During the first few months (three months -TBD-) the configuration is identical to the configurations in the "Operations" phase. During this "run-down" phase, the necessary transfer of knowledge from the MOC to the FSC, as well as final processing and archiving of the MOC-related data items, is carried out. At the end of the run-down phase the MOC is disconnected.

MOC operations team and FOT are disbanded. The Ground Segment configuration is shown in Fig. 6.

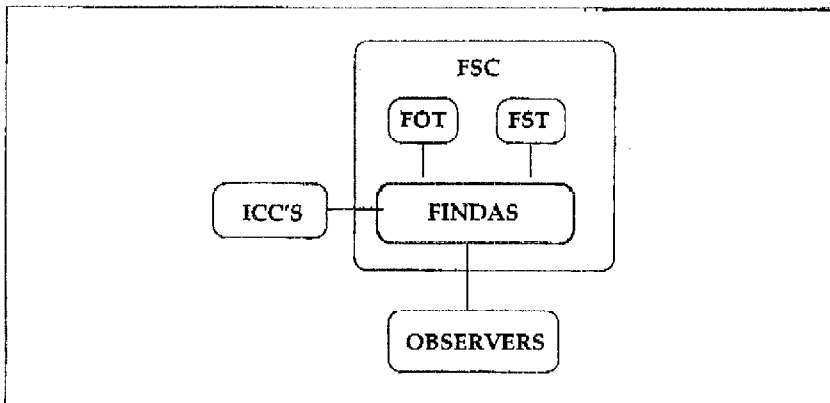

Figure 6: Post mission operations ground segment configuration

The main activity in this phase is the consolidation of the Archive. The duration of the post mission operations phase is foreseen to be 3.5 years (TBC). The goal at the end of this phase is to have an essentially completed, stand-alone, central Archive. This Archive shall become the sole source of all FIRST/PLANCK data for the Community. Some time during this phase all data will become public. They will thus become accessible to all Observers.

During this phase the indexing system which lists all the available information shall be consolidated. The index system will guide the users through their queries and retrievals.

During this phase the users' interface to the Archive will be improved if required. The "users" of the Archive during this phase will be a mix of "expert" users (ICC and FSC members), observers (who have submitted proposals) and "novice" users who have not submitted their own proposals but wish to carry out research on the available data.

The FINDAS data model shall be such that the overall Archive consolidation activity is as straightforward as possible.

The ICCs and the FSC will participate actively in the Archive consolidation phase.

Data items and data flows relevant to this phase are described in more detail in chapter 9.

4.5 Active Archive Phase

This phase starts when the previous phase is formally terminated. It is expected to last 5 or more years. It is not yet funded and might never be funded to any significant level. The state of the "legacy" Archive at the end of the previous phase must therefore be such that the Active Archive phase may run practically unattended.

The ICCs and the FST are no longer active (at least as such). The only "users" of the Archive are then the scientific community at large. This phase is of no real significance for FINDAS since all FINDAS-related activities (except, possibly, a minimum level of software and hardware maintenance activity) are essentially completed at the end of the previous phase.

Fig. 7 shows the Ground Segment Configuration during this phase.

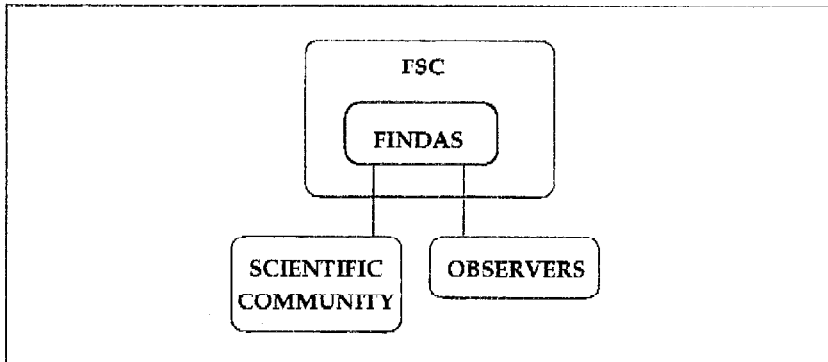

Figure 7: Active archive ground segment configuration

FIRST FINDAS Ground segment

Data items and data flows relevant to this phase are described in more detail in chapter 10.

Preliminary data model

DRAFT

15

5 Instrument Level Development and Test

Figure 8 depicts the groups and data involved in this phase.

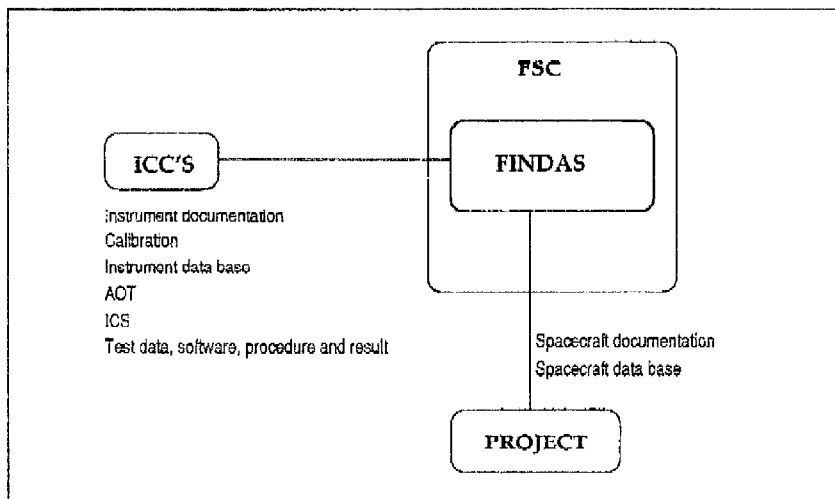

Figure 8: Instrument and spacecraft development

The final goal of the development phase is the delivery of a fully calibrated instrument. This is also true for the spacecraft itself. This leads to a quite extensive set of documents which must be handled via FINDAS like minutes of meetings, electronic mails, normal documents up to instrument and spacecraft user manuals and flight operations procedures. Included are also documents describing the whole development cycle of the software necessary to operate and characterize the instruments/spacecraft, i.e. user and software requirements documents, detailed and architectural design documents, test procedures and results and software problem reports.

In order to operate the instruments/spacecraft it is necessary to define the telecommands and the structure and content of the downlink telemetry packets. The instrument/spacecraft data base contains then the location and description of all housekeeping parameters, their conversion tables to create physically meaningful values, their hard- and soft-limits and how they are affected by telecommands.

Telecommands can be grouped into instrument/spacecraft command sequences (ICS) defining certain actions, i.e. the move of a scanner from a start to an end position taking into account a certain step size.

Test procedures are a series of command sequences for the testing of subsystems and/or special instrument/spacecraft modes. AOT's are a series of instru-

FIRST ~~FINDAS~~ Instrument Level Development and Test

ment command sequences defining a certain setting of an instrument in order to execute an astronomical observation.

The analysis of the obtained data leads to test results and to calibration data sets.

Figure 9 depicts the sequence of processes and the evolution of data during the development phase.

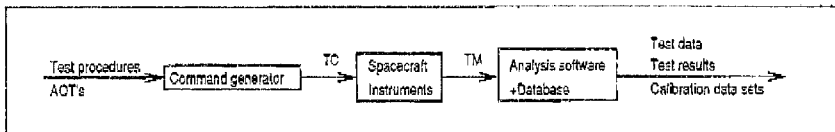

Figure 9: Instrument and spacecraft development data flow

6 Check-out

Figure 10 depicts the groups and data involved in this phase.

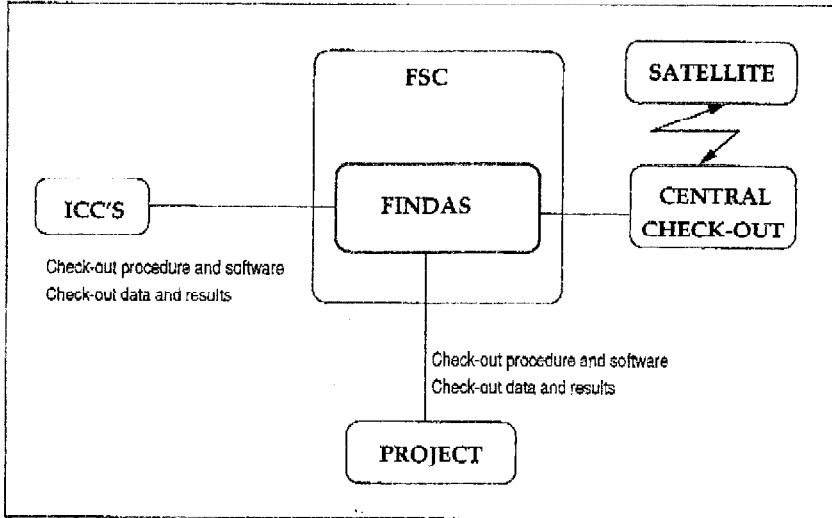

Figure 10: Check-out

Check-out is the next step after the development phase. All subsystems including instruments are now integrated in the spacecraft which is connected to the central check-out equipment which later on during the mission will be replaced by the mission operations facilities.

Special check-out procedures similar or even identical to the test procedures and AOT's used during the development phase will be executed and the analysis of the obtained data will lead to a further characterization of the behaviour of spacecraft and instruments.

Figure 11 depicts the sequence of processes and the evolution of data during the check-out phase.

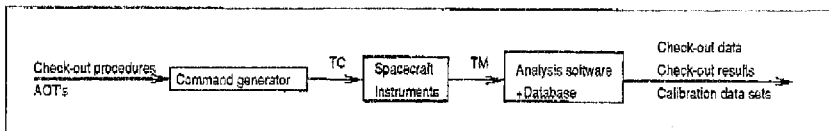

Figure 11: Check-out data flow

7 Mission preparations

The figure 12 depicts the teams and data involved in this phase.

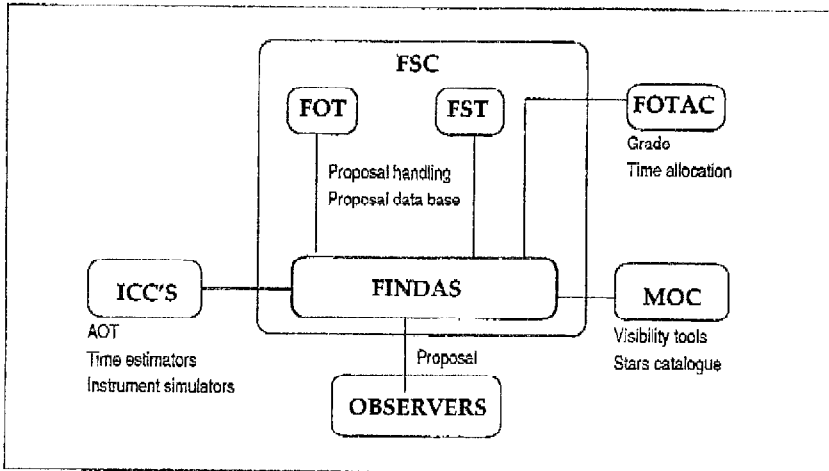

Figure 12: Mission preparations

The figure 13 depicts the sequence of processes and the evolution of the data during the mission preparations phase.

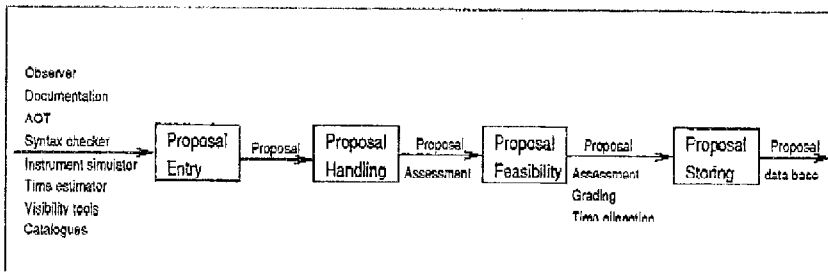

Figure 13: Mission preparations data flow

A scientist, registered as a guest observer with the FIRST observatory, submits a proposal for observation in answer to a "Call for Observing Proposals" issued by the FIRST Science Centre. A proposal is composed of a scientific justification to perform the observation and an instrument centered description of the observation.

To prepare the proposal, the observer consults the documentation, written by the ICC's and the FSC, and uses tools which have been developed by the ICC's

FIRSTFINDASMission preparations

and the MOC. The instrument based description of the observation uses the Astronomical Observation Templates designed by the ICC's, which the observer fills during the proposal entry phase. Filling in the parameters and data of an AOT, the observer can make use of astronomical catalogues, syntax checking tools and other facilities such as 'exposure' time estimator and visibility tools.

Once the proposal has been completed, its technical feasibility is evaluated by the FSC, this is the proposal handling process, resulting in a technical assessment. The proposal handling may involve some interaction between the FSC and the observer, for instance when the proposal duplicates another or to suggest joining the observation filed in by another guest observer. The FSC may use different tools and data sets than those available to the observer while technically assessing the proposals, for instance to produce statistical data for the FOTAC.

The proposal and its technical assessment are provided to the FIRST Observation and Time Allocation Committee, which following an evaluation of the scientific merit of the verified proposal, assigns it a grade and a time allocation (and as needed to individual observations within the proposal), this corresponds to the feasibility phase.

Completing this preparation phase, the proposal and its assessments are stored in the proposal data base, and the assessment is notified to the observer.

FIRST

FINDAS

Mission operations

8 Mission operations

The figure 14 depicts the teams and data involved in this phase, and figure 15 is a more detailed sketch showing the relations between the different data elements participating to the mission operations phase.

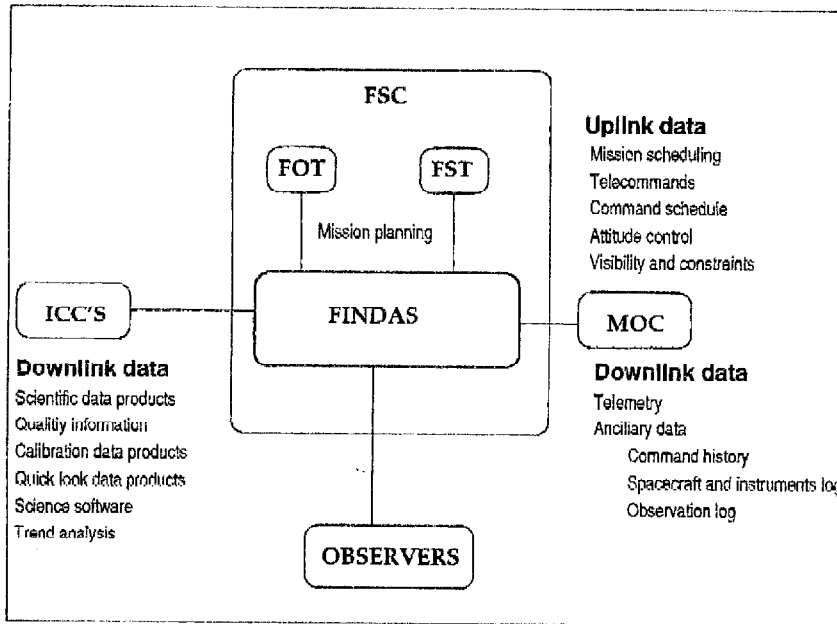

Figure 14: Mission operations

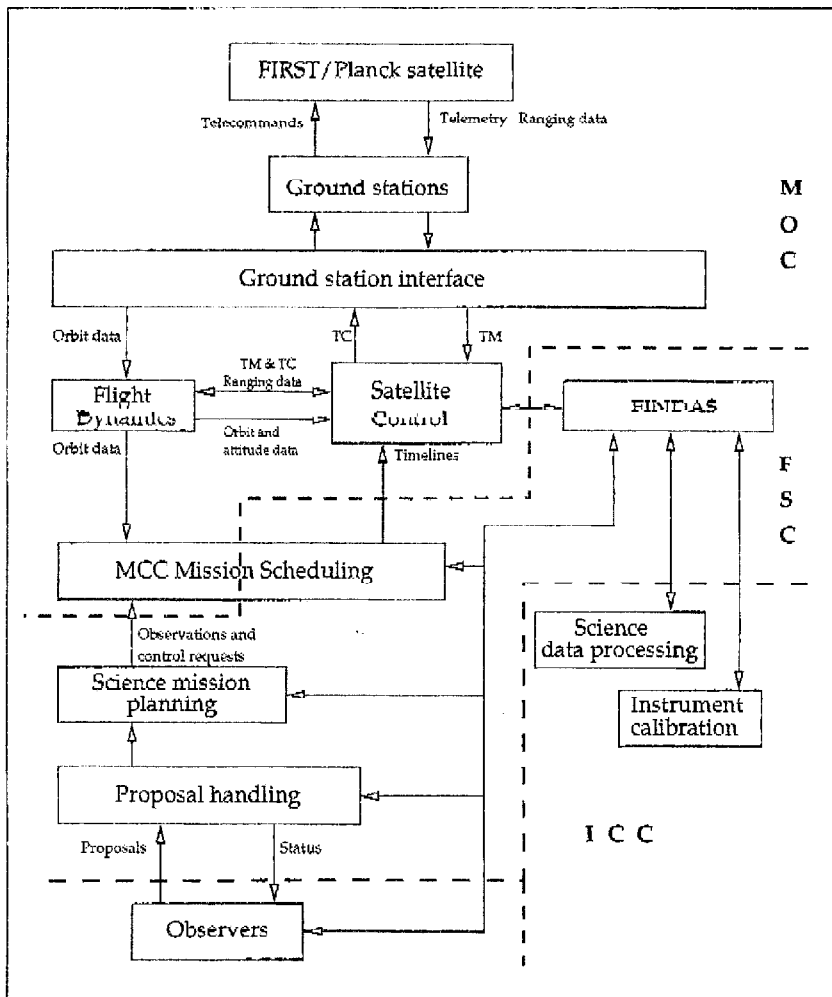

Figure 15: The mission operations phase ground segment

The figure 16 shows the sequence of data produced during the mission operations phase.

FIRST FINDAS Mission operations

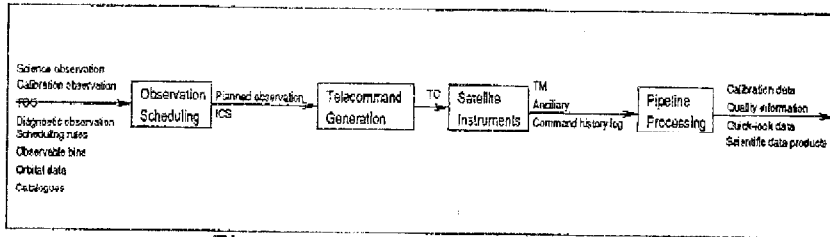

Figure 16: Mission operations data flow

The observation scheduler combines the observations suitable for scheduling from the proposal data base with orbital data and creates a detailed observing schedule. The process is guided by three major constraints: maximize the observing time, perform the observations with the highest scientific grade and satisfy the target visibility constraints. The two main outputs from the scheduler are a detailed schedule of observations and their associated instrument command sequences (**ICS**).

The schedule of observations and the ICS's, complemented by the commands necessary to operate the satellite such that the observations can be performed, are transformed into telecommands. The set of fully qualified and detailed telecommands, called the Central Command Schedule, is transmitted to the satellite for one complete period (i.e. the period during which the satellite cannot communicate with the ground stations). As the observations are performed, the data generated by the instruments and the satellite are recorded on-board. When the satellite enters into communication with a ground station, the recorded telemetry is played back and received by the MOC.

The raw telemetry received by the MOC is made available to FINDAS which stores it and makes it available to any ICC which requests it. The MOC monitors the satellite and instruments parameter values extracted from the telemetry and checks them against their specification stored in the satellite database, this is a real time type of verification for data integrity resulting in reports of the health of the satellite and the instruments. The MOC produces the ancillary data derived from the satellite telemetry, such as the command history or the attitude pointing data.

The telemetry, ancillary data and calibration data, are inputs to some standard science processing which generates scientific data products. These data products complemented by the reports from both the MOC and the ICC about the data integrity and eventually some science data evaluation form the result of the observation, from which the observer can perform his scientific research.

In the case of a calibration type of observation, it could be that the data obtained is further worked into calibration data sets and refined algorithms which may be integrated within FINDAS. Data may also be used as inputs to trend analysis programs.

9 Post mission

Figure 17 depicts the groups and data involved in this phase.

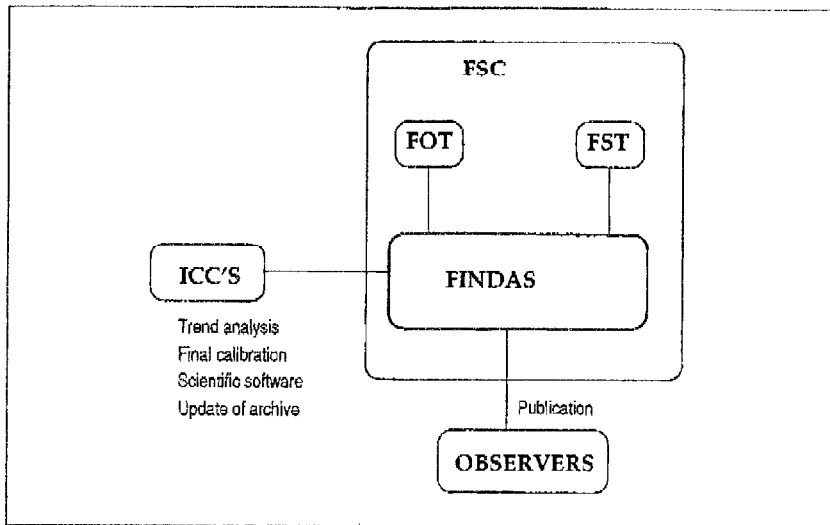

Figure 17: Post mission

It is assumed that the scientific data will be (if required) re-processed to an agreed level of quality. A preliminary list of data would be:

- Raw data
- Basic Scientific Data (processed using "standard" processing tools)
- Survey data
- Browser data
- Parallel and Serendipity data
- Calibration data
- Auxiliary data
- Diagnostic data
- Mission Planning data

FIRST

FINDAS

Post mission

In addition, interactive and non-interactive software processing tools, Calibration data derivation tools, Special processing tools, Instrument Models, Historical data, Documentation (spacecraft and instruments), published papers, etc. will be made available in the Archive. Figure 18 depicts the sequence of processes and the evolution of data during this phase.

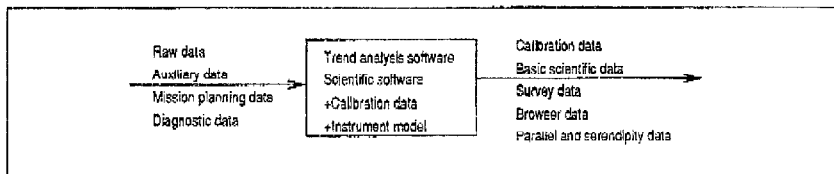

Figure 18: Post mission data flow

10 Active Archive

Figure 19 depicts the groups and data involved in this phase.

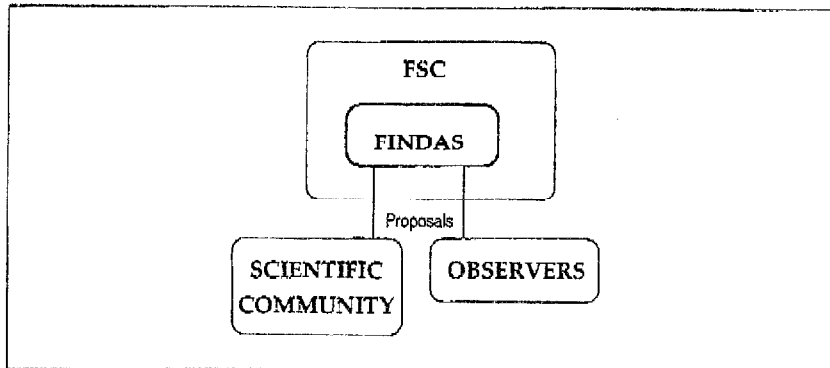

Figure 19: Active archive

During this phase the scientific community as a whole can remotely access the archive and use the latest version of the scientific software including all auxiliary and calibration data to reduce the data obtained from the scientific observations. This will lead to numerous publications which should be fed back into the archive. The data flow is nearly the same as during the post mission phase.

11 Roles and type of users

Appendix 1 of RDI (SOW) and chapter 4 in the SOW itself address various aspects of users categories, roles and access rights. This chapter provides additional information.

11.1 Common aspects

Whatever the type of users and their respective roles, needs and rights within the overall Ground Segment, some common aspects can be identified. They are listed below:

- All users interact with FINDAS.
- All users manipulate different data entities while fulfilling their roles but the basic categories of objects manipulated are always the same: (1) data, (2) Software programs and tools, (3) documentation (including graphics and pictures).
- Some categories of users interact with FINDAS during several different phases (as described in chapter 4) of the overall mission., e.g. observers during mission preparation, operations, post operations and Archive phases. FINDAS must provide a unified "view" of the overall system to them while they manipulate the same entities (seamless phase-to-phase transitions).
- The most basic operations required (depending on rights) are always the same: store, update, search, retrieve, display. FINDAS shall carry out each basic operation in a consistent way, throughout all phases. FINDAS shall always ensure that, unless otherwise explicitly specified, users requesting a data item always get the "latest" version of the item. Users storing data items should not have to worry about keeping track of the various versions of these items (configuration control).
- Access to FINDAS shall always be, safe, quick and easy. When access to a data item is not immediate (more than a few seconds) feedback on the time remaining to complete the request shall be provided to the user.
- If data items which are the target of a request are unavailable -for whatever reason- the requester shall be informed.
- FINDAS shall present to the users "views" (in the classical Data-Base sense) of the data which support the activity they are carrying out and their level of expertise, hiding the complexity of the underlying data model.

FIRST	FINDAS	Roles and type of users
-------	--------	-------------------------

- Syntax checking shall be performed on the fly for interactive actions (e.g. "form" filling) and immediate feedback to the user in case of error. Context sensitive editing, and on-line help shall be provided. Users Manuals shall not be required to use an interactive tool.

11.2 Expert users

MOC, FSC and ICC staff are considered "expert" users. They will have been exposed to FINDAS from an early stage and collectively possess intimate knowledge of the spacecraft, instruments, and operating procedures. They generate most of the data item stored into FINDAS during the preparatory phases of the FIRST mission. In the early phases the information they generate and manipulate changes often. Addition, deletions, updates are very frequent. FINDAS shall make these operations simple, providing at the same time a high level of security (configuration control). Aspects of user's interface are (possibly) less important to them. It is less important for FINDAS to help them, guide them, and more important not to get in their way... Flexibility is essential. Most requirements are common for the expert users and the expert observers (See 11.3.3).

11.3 Observers

Most Observers (at least initially) will be "novice" users. They put the maximum demands on FINDAS in terms of sophistication of the user's interface required, speed of access and friendliness of the overall system. They are, therefore, described in more detail. The differing characteristics of these users imply different requirements for the "queries" and "views" of the data stored in FINDAS, product quality, speed and availability of processing software.

11.3.1 Browsers

They want to quickly scan or preview pictures. Their "searching" into the archive is of an exploratory nature. They will access mainly "quick-look" products. They require very little specialized software tools. Archive reaction time must be in the order of seconds and a "simple" interface is adequate. This interface could consist of standard, pre-defined yet flexible queries. It is expected to be tailored to straightforward and predictable astronomical requests:

- The interface should, wherever possible, identify search requests which are meaningless, likely to fail or likely to take an inordinate amount of time, and should warn the user quickly.
- The search interface should support the following types of queries, which the user should be able to combine freely (these are examples of likely requests):

Preliminary data model

DRAFT

28

FIRST	FINDAS	Roles and type of users
-------	--------	-------------------------

- Search on a position (RA and DEC, galactic coordinates, ecliptic coordinates).
- Search on a list of coordinates.
- Search by target name.
- Search by wavelength.
- Search on details of observations (Instrument, AOTs, aperture, etc.).
- Search by flux level.
- Search by colours.
- If a large number (say 20) of matches are found the user should be given the option to revise the query.
- For very large data sets the user shall have the option to view a subset only (e.g. 10 first matches, or every 10 match, etc.).
- When reviewing specific observations (e.g. its own) the user should have the possibility to access summary or full details.

11.3.2 Survey researchers

They want to extract large groups of sources of a given class. Not much processing software is needed. Access time is not an important issue for these users.

11.3.3 Expert observers

They will want the highest fidelity in the processing of their data. They will work on one source (or a small subset of sources). They require access to sophisticated processing and calibration software. They are often the same users as the "experts" described under 11.3.2. They require an expert user's interface, which is not necessarily friendly. These users (as the users under 11.2) need access to all the contents of the Archive - including auxiliary data- (access rights permitting). They shall be able to specify their own queries. Queries based, at least, on the basis of observations and time shall be possible.

11.4 Final note

The distinction between the categories of "expert" and "novice" users is sometimes blurred! A correct implementation would strike a compromise between possibly conflicting requirements.

12 Project guidelines

Project wide guidelines should be applied to FINDAS and within the development efforts at the centres using its facilities, the most important are:

- Uniformity** Data structures, processing structure and user interfaces are common to all centres. All specific elements are well isolated. For instance a commonly agreed observation request with 'undo' facility, and ordering of data from general to instrument specific parameters.
- Adaptability** The design of the system is such that changes in requirements do not provoke a redesign of the system.
- Scalability** The number of data elements, total volume of the data and complexity of their relationship calls for a design with scalability in mind, to avoid performance degradation.
- Durability** The projected long lifetime of the system calls for a careful implementation in this context. For instance tools and COTS components need to be carefully chosen.
- Robustness** The system shall behave adequately in averse conditions. For instance if the link from FINDAS to an ICC fails while telemetry is transmitted, this shall not prevent FINDAS to collect the incoming data from the MOC.

13 Review

This section reviews the data described previously, highlighting commonalities and differences between them. The high level description presented here and in the next chapter are views inciting the reader to challenge them and propose alternatives.

13.1 Observation, calibration, ToO

There are many common points between these three modes of observations. All three start from a request to perform some observation using a given instrument. Compared to an observation, a calibration requires expert knowledge of the instrument and relaxed rules for the validity and compatibility of parameters. Many calibrations can probably be standardized or most of their specifications can be captured in frameworks, leaving fewer parameters to be changed. On the other hand classes of ToO's can be designed using standard templates or use the calibration templates occasionally.

From these templates on, the process leading to a set of commands to be uplinked is identical. In effect each instrument (in the data model the satellite and its subsystems are also seen as an instrument) responds to a known set of commands, and thus whether the telecommands they receive stem from an observation or a calibration is irrelevant.

For the telemetry downlinked, processing in the ground segment is also similar for the three categories. Telemetry is fed into two systems, one for immediate assessment of the data (and this is probably independent of the origin of the data), one for processing the data to generate products. Even though one might argue that the process applied to calibration data is different from the pipeline process applied to observation data, the general principle is the same: collect data sets and apply a transformation to them and store the result.

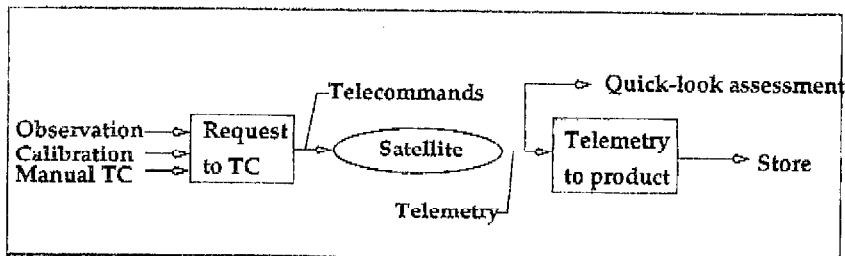

Figure 20: Observation, calibration, ToO

If we focus on what is happening during an observation, we note that besides the primary instrument, the other instruments and the satellite are in a defined

state. Hence to perform an observation it may be necessary to send telecommands to all other instruments and to the satellite. For instance when the prime instrument AOT is sent up, also parallel mode AOT's must be sent for the non-prime instruments, or, prior to the observation, the satellite's AOCS might be commanded to point towards the target to observe.

Furthermore looking at the telemetry downlinked, we find that not only the science data from the primary instrument is important, also the telemetry from the satellite (from which the ancillary data is derived) is used by the processing pipeline.

We can combine the AOT's of the three instruments with the satellite information necessary to perform the observation into a high level component which we call a Scheduling Unit.

A *Scheduling Unit (SU)* is composed of a set of *Astronomical Observation Templates (AOT)* and a *Satellite Template (ST)*.

One AOT relates to the primary instrument, while the other instruments are in a mode compatible with that of the primary. The satellite template specifies any constraint imposed on the spacecraft by the observation carried out with the primary instrument.

This structure brings a unification of the uplink system and opens the possibility to optimize the commands to be uplinked. As a side effect of this unification, the instrument teams will be aware of the other instruments possibilities early in the project development and could find alternative observation scenarii. This could also benefit the design of the 'time calculator' used to assess the duration of observations (all relevant data for all systems are already in place for the calculation).

For the downlink aspects, the processes applied to the telemetry also follow a consistent pattern in which all elements are described within the Scheduling Unit, at AOT level.

13.2 Other data

The most important of the 'other data' is the data associated with the scheduling of observations. Assuming that the SU contains all the necessary information for a scheduler to work (for instance target coordinates and duration of the observation), the schedule is a set of time tagged SUs. To prepare the telecommands, all the files are already present in the AOT's and are maybe a concatenation away from being ready (while assembling the telecommands the time tags or other informations can then be added).

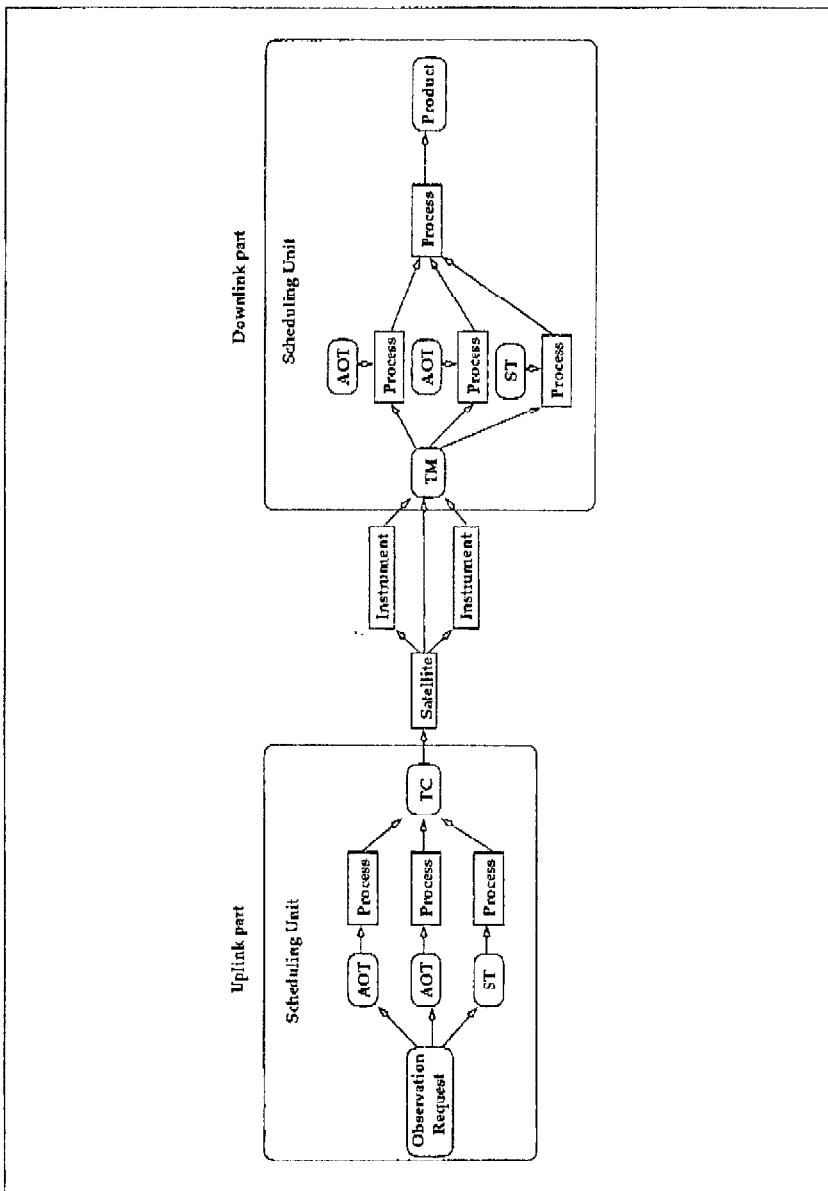

Figure 21: Scheduling Unit

14 A possible data structure

In this first attempt at defining and organizing the data, clearly not all aspects are present. This chapter gives an idea of a possible organization and is meant as a trigger for further thoughts or reorganization of the whole.

14.1 Top level

The following structures could be major components of the data system:

- **Observation:** All information given by the user to perform an observation, completed by the results from the instantiated observations. An observation may result in multiple SU's.
- **Schedule:** a set of timely ordered SU's.
- **SU:** contains all information for the end-to-end instantiation and realization of an observation.
- **AOT:** instrument mode of operation information is gathered within the AOT.
- **Instrument:** all information related to the instrument.

14.2 Schedule

The Schedule as mentioned before is an ordered list of instantiated SU's. The instantiated SU contains fixed telecommands for uplinking and telemetry after the observation has been performed. The instantiated SU are produced by the scheduler.

14.3 Scheduling Unit

The SU contains the information describing completely one observation, among which:

- **Priority.**
- **Type:** calibration, observation, engineering, etc.
- **Scheduling:** time, etc.
- **Duration.**
- **Target:** information about the target to be observed such as its type, location.

FIRST FINDAS A possible data structure

- AOT: the list of AOT's defining this observation.
- Telemetry: complete raw telemetry produced during the observation execution.
- Products: products which are not bound to a specific AOT, either because they cross the AOT domains or because they are the results of different processes than what the AOT's support.

At the SU level the data is more of a general order, details being delegated to more specific structures like the AOT.

14.4 AOT

The AOT relates to an instrument used in a specific mode. It is the main source of information for both the up and down link streams, but also describes data transformation processes. Its contents is:

- Instrument: data used in the science processing (user manual as well as calibration or pipelines).
- Instrument Command Sequence: the actual telecommands used to drive the instrument during the observation.
- Telemetry: instrument telemetry before any pipeline processing has been applied.
- Products: products which are generated automatically by the system.

14.5 Instrument

The instrument structure is the motor behind the scene, it will be the first structure to be instantiated. The structure will contain both generic information about the instrument (institute building the instrument, principles of operation manuals, calibrations), as well as specific information (related to the various modes of operations and thus related to AOT's). The structure of the instrument data could contain:

- Institute: personalia, points of contact, mail addresses, etc.
- Document
- Calibration
- Uplink, describing the steps from the AOT to the telecommands instantiation.

FIRST FINDAS A possible data structure

- Downlink: describing the processes to generate products from the telemetry data.

The instrument data probably has both the generic aspect (calibration could be applied to any mode of operation) as to specific modes (some calibration are valid only for some modes of observation).

15 Data management

A number of issues concerning the data management are roughly exposed in the following sections. Their aim is to provide some inputs which the FSODG finds important in the way FINDAS manages its data (cf. the concept document). The description given here is meant to incite the developer to propose better schemes to cover all aspects of data management.

15.1 Configuration control

Any data item within FINDAS shall have a tag identifying its state. The evolution of this tag is represented as follows:

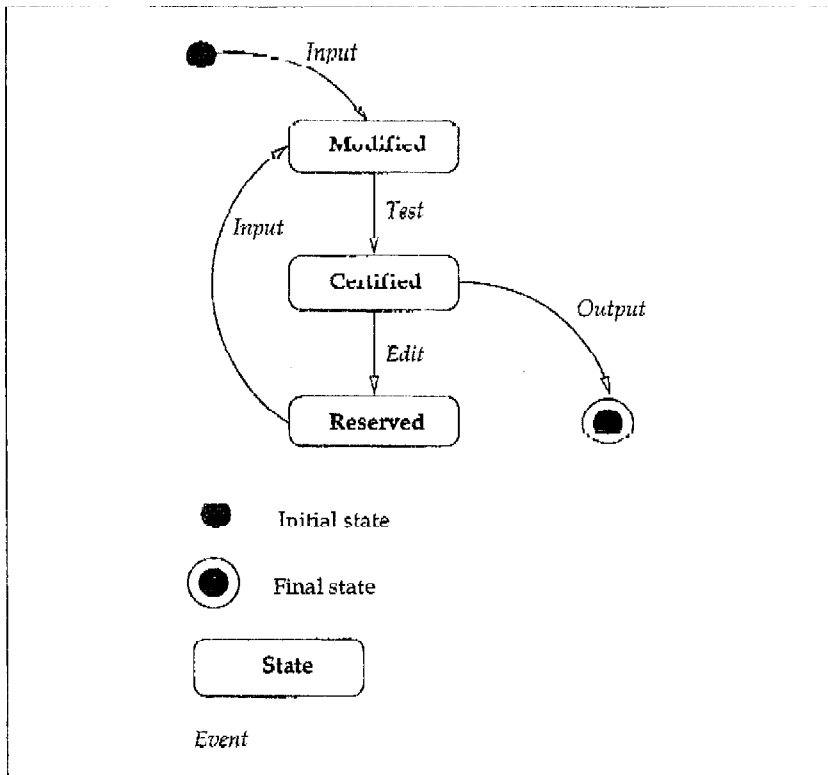

Figure 22: Configuration control state diagram

An incoming data element introduced within FINDAS, either at creation or

after a modification, is submitted to some test which can be empty. When the test has been successful, a new version tag is attached to the data which is then available to users who can extract the data into their own area (local or remote). As data is extracted for modification it is also locked in such a way that any other editing request will be rejected, giving the requester only the currently validated data (possibly an indication of the current 'owner' of the data element).

15.2 Group, users and rights

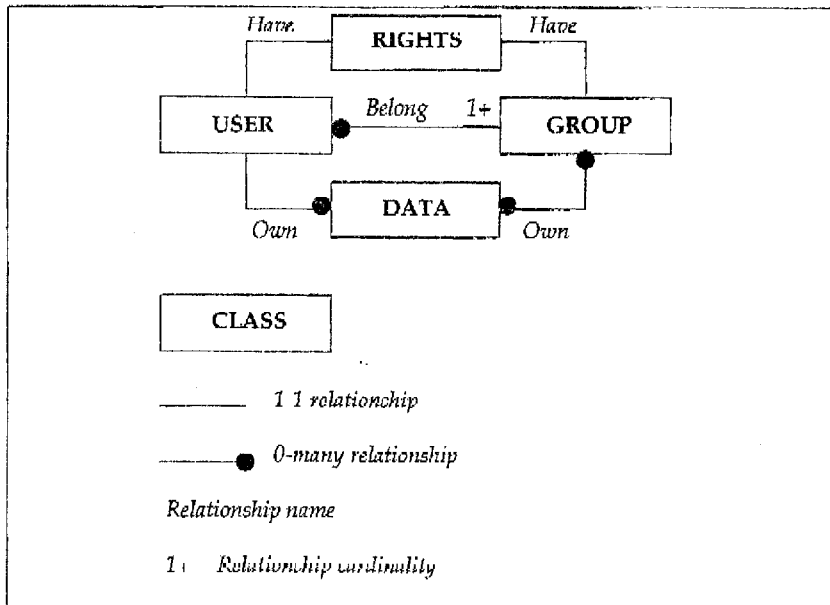

Figure 23: Groups, users and rights diagram

A user is part of at least one group, but may belong to several groups, for instance an ICC technical manager belongs to an instrument group as well as the instrument verification group and in that role can test and certify instrument software. Both users and groups are given rights representing the type of operations they can carry out with the data. Any data item is owned by its creator (a user), and the set of groups to which the user belongs has read access, at least at the time of creation. This is but an indication of a possible access facility to the data (for instance observation data may need a different initial access set than that of a general document).

The rights expected to be needed for any objects are as follows:

<u>FIRST</u>	<u>FINDAS</u>	<u>Data management</u>
--------------	---------------	------------------------

- Read: gives the possibility to extract the data and import it to a local or remote area.
- Edit: gives the possibility to extract the data and lock it such that subsequent accesses are in read mode until that data has been certified.
- Certify: allows the user to post a new instance of the data within FINDAS.
- Exclusive: a date up to which the data is owned by the user exclusively. At expiration date, the data is released from its exclusive ownership.
- Manage: Allows modifications of rights.

A Data components

The data described below do not imply any implementation constraint, but describes a large part of the data used within the frame of the FIRST project.

A.1 Archive catalog

Under the responsibility of the FSC, this catalog holds information about every item stored by FINDAS. The information describes the item and its evolution with the log of access to it. The catalog is searched by users and by processes.

Searches from users are context driven with keys such as file types, period of creation, group ownership or by observation identifier. The main reasons for user queries are either to display the contents of the selected item(s), or for transfer the items to his own site. The queries from the user should be supported by a history mechanism.

Some items might not be accessible by the requesters, for instance a user does not have access to items which have not been certified or observations which are exclusively owned by another user. Unaccessible items should not be part of the set resulting from a query.

A.2 Satellite data

The satellite data files mainly relate to the operations of the spacecraft and its instruments during the mission phase.

A.2.1 Telecommands

The telecommands sent to the spacecraft by the MOC, are preserved in the *Command History*. The commands relate both to the spacecraft and to the instruments. The data size is in the order of 11 Kbytes per day.

A.2.2 Telemetry

The telemetry, in raw form, corresponds to the spacecraft housekeeping and science data in packets. The telemetry is received from the MOC by FINDAS in near real-time and should be made available to requesters. The data size is in the order of 735 Kbytes per day.

A.2.3 Attitude data

Along with the telemetry, the MOC also provides the *Attitude Pointing History* to FINDAS in near real-time. It is extracted from the raw telemetry and includes references to the guide star used.

A.2.4 Orbit parameters

The orbit parameters, under the responsibility of the MOC, comprise all the orbital elements which are used by the mission scheduling system.

A.2.5 Observation

Under the responsibility of both the MOC and the PSC, the *Observation History* reflects the status of each observation: scheduled, executed, failed.

A.3 Satellite and instrument database

A.3.1 Satellite database

This data defines how to interpret the values of the parameters found in the telemetry. Each telemetry parameter for the spacecraft and the instruments is defined together with calibration curves, or x-y mapping tables for instance. Information concerning the presentation of telemetry parameters on synoptic could also be part of the definition of the parameters. The information under the responsibility of the MOC is provided by both the MOC and the FIRST project team.

A.3.2 Telecommand database

This data defines all the telecommands for the spacecraft and the instruments.

A.3.3 Instrument Command Sequences

Provided by the ICC's the instrument Command Sequences (ICS) are grouped in a set. The sequences are like macro instructions which after processing will be mapped into telecommands. For instance a macro command to power on an instrument is split into a set of macro instructions to assert power availability, then an orderly sequence of power switching of various elements, etc...

A.3.4 Astronomical Observation Template

The current set of AOT's provided by the ICC's is available on-line, while previous instances may be preserved off-line.

A.3.5 AOCs calibration and guide star catalogue

This data is under the responsibility of the MOC.

FIRSTFINDASData components

A.4 Operations planning data

The information in this group of data covers the aspects from the proposals of observation up to the preparation of telecommands. By nature these data are 'centered' around the observation scheduling process.

A.4.1 Proposal data base

Containing all the informations related to the observation proposals submitted to the FSC.

A.4.2 Mission data base

This data set contain the observations which are suitable for scheduling, cover the whole mission and is under the responsibility of the FSC.

A.4.3 Central Command Schedule

This data set contains the actual data to be uplinked for one orbit. The MOC is responsible for these data. A summary per period is also preserved.

A.4.4 Visibility data

The set of information, under the responsibility of the MOC, contains constraints used by the scheduling processes to plan the observations.

A.5 Calibration data

A.5.1 Pre-launch instrument calibrations data

ICC's provide relevant data resulting from ground measurements.

A.5.2 External calibrations data

Provided by the FSC, the external data could be from ground-based preparatory programs or other satellite experiments.

A.5.3 Calibration Target List

Under the responsibility of the FSC, provided by the ICC's, the target list contains reference data against which calibration observations could be performed.

FIRST	FINDAS	Data components
-------	--------	-----------------

A.5.4 Spacecraft calibration data

Provided by the MOC, this data provide information concerning for instance the pointing of the instrument with respect to the information provided by the spacecraft telemetry.

A.5.5 Instrument calibration data

Provided by the ICC's the data relates to the various modes of operations of the instruments and provide the needed information for the correct interpretation of the instrument telemetry.

A.6 Operations plans, procedures and software**A.6.1 Plans and procedures**

Flight Operations procedures, Flight control procedures, Contingency recovery procedures and ground segment procedures. The equivalent procedures are provided by the ICC's to the MOC for each instrument.

A.6.2 Ground based test plans

All parties (FSC, MOC and ICC's) provide the data for tests at instrument level until the final ground segment simulations.

A.6.3 Memory images

Both on-board memory images (loaded and dumped) are saved in FINDAS for all sub-systems of the spacecraft and for the instruments.

A.6.4 Trend analysis results

From the processing of telemetry parameters, the evolution of the behavior of the systems are characterized to be used in further processing (for instance in the calibrations systems).

A.7 Administrative data**A.7.1 Documentations, newsletters and updates**

All documents produced within the framework of the FIRST mission. These cover manuals for the instruments and the spacecraft, but also the documentation covering the various software involved in the ground segment activities.

FIRST	FINDAS	Data components
-------	--------	-----------------

A.7.2 Call for observing proposals

Containing informations to emit the calls for proposals, for instance reserved time for selected targets, observers manual,etc ..

A.7.3 Reports and statistics

From various origins.

A.7.4 Software problem and anomaly reports**A.8 Auxiliary science data****A.8.1 Astronomical catalogs**

For instance star catalogs and observatory catalogs (ISO, Hipparcos for instance).

A.8.2 References to scientific papers**A.9 Software and tools**

All software and tools created or used within the framework of the FIRST project. The software and tools data are sources, binary and procedures to build the binaries from sources.